



Commercial  
Vehicles

# Caddy vans

## Panel vans

Great for tools and cargo

## Maxi panel vans

More length for longer loads

## Maxi kombis

Take your crew, too



## Size that matters

The compact Caddy is packed with features that will help your business

# Whatever you need, there's a Caddy for you



THE CADDY is a versatile, city-friendly van that's perfect for your business. Compact yet super-spacious, the standard Caddy panel van will carry all kinds of loads. If you need even more load-carrying capacity, pick the long-wheelbase Maxi panel van. There's also a Caddy Maxi kombi that lets you carry five people in comfort with plenty of load space to spare.

Thanks to Volkswagen's advanced TDI diesel engines – with the option of BlueMotion Technology for even greater efficiency – the Caddy is incredibly economical, helping you save money in the long run. And they come with a great three-year warranty and support package.

You can also customise your van with cost-effective trimlines and an extensive range of factory-fit options. All you have to do is pick what's right for you.



Caddy Maxi panel van >p16



Caddy panel van >p14



Caddy Maxi Kombi >p17



## Contents

All your Caddy buying questions answered

- What's it like to drive? >p6
- What engines are available? >p10
- Which model is right for me? >p14
- What trims can I get? >p18
- How much will my van cost? >p20
- What options can I add? >p36
- What are the key facts and figures? >p52
- What support can I expect? >p58

CONTACT US ON:

0800 717 131

www.volkswagen-vans.co.uk

GET CONNECTED:

@Volkswagen\_CV

VolkswagenCommercialVehiclesUK

vwcommercialvehicles





# Delivering the goods. It's what we've always done...

Today's much-loved Volkswagen vans are only the latest step in a 60-year journey that started with one clever idea

**B**ack in 1947, Dutch importer Ben Pon spotted workers at Volkswagen's Wolfsburg factory using a stripped-down Beetle to move parts and machinery around. Inspired, he sketched the platform for a versatile commercial vehicle that could be adapted to a wealth of uses. From this, the Transporter was born, and eventually the more compact Caddy came along. Since then, the van world has never looked back.

Today, Volkswagen vans are more popular than ever, with a diverse model range – from the Transporter, sturdy Crafter panel vans and dropsides, to the Caravelle passenger carrier,

Amarok pick-up and, of course, the Caddy. They're as versatile and dependable as Volkswagens have always been, but now they're even more spacious, more comfortable, easier to drive and more fuel-efficient than ever. They're also backed by a Van Centre network that's ready to solve any problem you may have, too.

Getting the job done efficiently and reliably has been at Volkswagen's heart for the past 60 years. It's a reputation for rugged reliability that has endured over the decades. And that's why you can count on us to deliver a van that works for you, today.



# Driving

Get from A to B  
easily and in comfort



## Take the strain out of daily driving

The Caddy is brilliant for everyday deliveries – and options such as DSG and 4MOTION® four-wheel drive make driving even easier

**T**he Caddy's powerful, efficient TDI turbo-diesel engines deliver plenty of torque for carrying heavy loads, and its compact, city-friendly dimensions make it a pleasure to drive. In fact, the Caddy panel van is about the same length as a family hatchback, so it's incredibly easy to park – especially with the addition of optional parking sensors.

### Geared up for easy shifts

Every Caddy comes with an easy-to-change five- or six-speed manual gearbox with an easy-to-reach gearlever. You can also opt for the convenience of our seven-speed automatic Direct Shift Gearbox (DSG) – great for city driving.

### Add some off-road ability

If you'll be driving off-road where more traction is required, consider the Caddy Maxi's optional 4MOTION® system. It delivers true all-wheel-drive performance when needed, but – in normal conditions – it reverts to driving only the front wheels to ensure maximum fuel economy.

### Safety comes as standard

The Caddy is packed with features that help keep you – and your goods – safe on the road. Volkswagen's advanced ESP (Electronic Stabilisation Programme) works with ABS (Anti-lock Braking System), EDL (Electronic Differential Lock) and TCS (Traction Control System) help keep you out of harm's way. All these features are fitted as standard on every Caddy and work without you having to lift a finger.



The Caddy's car-like driving characteristics make getting to your job a pleasure

### Driving tech explained



### Direct Shift Gearbox (DSG)

Our seven-speed, Direct Shift Gearbox (DSG) is great for city driving. It can be used either as a fully automatic gearbox or as a quick-shift manual – just nudge the gearlever forwards or backwards to change gear up or down.

### 4MOTION

4MOTION® is an all-wheel-drive system that helps you to maintain optimum grip, especially in slippery conditions. If one wheel loses traction, 4MOTION® reacts in milliseconds to send more power to the wheels that have the most grip.



# Equipped for everyday work

Your Caddy's cab is designed to be the perfect fit. It comes with plenty of practical features to keep your business moving

You're likely to spend a lot of time in your van, so it has to be comfortable. You'll also want to stay in touch with colleagues and customers to keep your business working. That's why we've built the Caddy's cab around you – with both comfort *and* work in mind.

## A cab that fits like a glove

The Caddy features ergonomically designed seats that offer terrific support, and have height, reach and rake adjustment. The steering column is adjustable, too, so you can find the perfect driving position. Speed-sensitive power-assisted steering means you never have to work hard at the wheel, and remote central locking adds even more convenience.

## Stay connected on the move

Your clients want to be able to reach you all the time. That's why we offer optional Bluetooth® connectivity, allowing you to connect your phone and speak while on the move. A selection of high-quality audio and satellite-navigation systems can also keep you entertained and on the right road wherever you are.



The standard RCD 210 radio has an aux-in socket for your phone or MP3 player

## Ultra-clear dashboard

All controls are easy to use, so you stay focused on the road. You can add a multi-function steering wheel, which lets you use a range of systems without taking your hands off the wheel.

## Great sound

Every Caddy gets an RCD 210 radio with CD player and aux-in socket. Alternatively, you can choose a radio or sat-nav upgrade – we've got a wide choice of options.



## Fresh air all the time

Standard dust and pollen filters help prevent allergies from affecting your driving. You can choose to fit air-conditioning or climate control to help keep you refreshed all day long.

## A clear view ahead

A huge windscreen offers great visibility, so you'll know what lies ahead. You can add optional automatic rain-sensing wipers to make life even easier.

## A clear view behind

Tall door mirrors help you judge the height of your van and its position in tight spots. If you add electric windows and mirrors, you'll never have to stretch over to the passenger side to adjust the mirror again.



## Plenty of places to store your stuff

WORKING VEHICLES don't just carry the load in the rear – the cab also stores all the clutter that fills your working day. That means invoices, drinks, laptops and more. You'll find plenty of cleverly designed storage areas in every Caddy – an open glove compartment, roomy door pockets and more storage spaces in the centre console and roof.





# Engines

Technology that helps to cut fuel bills and lower emissions



## Intelligent power to drive you on

The Caddy's TDI turbo-diesel engines are at the forefront of technology, bringing you outstanding power with superb efficiency

**F**uel is only ever likely to become more expensive, so our engines are designed to bring you more power while using less fuel than ever before. At the heart of the Caddy's impressive performance is a choice of flexible turbo-diesel (TDI) engines. Each delivers outstanding power with commendably low fuel consumption and CO<sub>2</sub> emissions.

### Versatile engine choices

The Caddy engine range starts with the frugal 75PS 1.6TDI engine, and goes all the way up to the torquy 140PS 2.0TDI, which is great for carrying heavy loads.

### Go even greener

If you want to take your fuel efficiency to a whole new level and cut emissions even further, you can always add BlueMotion Technology to your engine package. To find out more, simply turn the page.



## Tips to save you even more fuel

### Add a sat-nav

A sat-nav can plot shorter routes and prevent wrong turns – some can even help you navigate around traffic jams. It all helps to cut fuel consumption.

### Driver training

Training can teach you to drive more economically and safely. Ask the Freight Transport Association ([www.fta.co.uk](http://www.fta.co.uk)) for details.

### Check your tyre pressures

Up to 20% of fuel consumption comes from the tyres' rolling resistance. It'll be even more if your tyres are underinflated, so check them regularly.

### Use your gearshift indicator

A gearshift indicator is fitted to all Caddys. It helps you to change gear at the most efficient times.



# More miles, less impact

BlueMotion Technology lowers your van's running costs and CO<sub>2</sub> emissions, and it's available on most Caddy models

If you want to lift the fuel efficiency of your Volkswagen Caddy to a whole new level – and cut emissions even further – you can always add BlueMotion Technology to your engine choice.

## The power of technology

BlueMotion Technology is a combination of energy-saving solutions – start/stop, Hill Hold Assist, low-rolling-resistance tyres, energy recuperation and cruise control. Working together, they reduce CO<sub>2</sub> emissions and significantly improve fuel economy. Over the life of your vehicle, that could lead to a significantly lower whole-life running cost, as well as lots of time saved at the pumps.

## Savings without compromise

Another benefit of BlueMotion Technology is that the savings come without compromise to the way you work. You can still add trimlines – such as the Trendline or Highline – to vans that have been fitted with BlueMotion Technology, as well as most other factory-fit options. Your Van Centre can help you choose the best specification for you.



### Cruise control

By keeping your vehicle at a constant speed, cruise control saves fuel that would normally be wasted when your speed fluctuates. It's especially useful for driving over long stretches, because it stops your speed creeping up unintentionally and reduces the driver's physical workload.



### Hill Hold Assist

Helps you make a smooth, efficient getaway, every time. On steep inclines, the system holds the brakes at the optimum level to prevent you rolling back. This reduces the need for you to rev the engine unnecessarily.



### Start/stop

Allows you to save fuel at lights and in traffic. When you stop, put your van in neutral and release the clutch, the engine automatically switches off, saving fuel and reducing emissions. When you're ready to go, depress the clutch and the engine starts up again.



### Energy recuperation

When braking, energy during deceleration is wasted. Our energy recuperation system uses some of that momentum to run the alternator and charge the battery. If the battery is well-charged, the engine has to do less work turning the alternator to keep it topped up. This cuts fuel use and emissions.

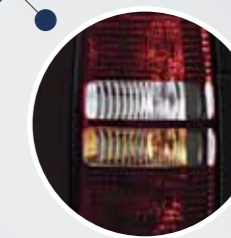

## How BlueMotion Technology works to lower your fuel bills and CO<sub>2</sub> emissions

BlueMotion Technology is available on Caddy and Caddy Maxi panel vans, and consists of four clever elements. Together, they significantly reduce fuel consumption and CO<sub>2</sub> emissions, which keeps money in your pocket and reduces your impact on the planet.





# Models

A choice of vehicles for different load lengths or more passengers



## Caddy panel van

# Small van, big loads

The best things come in small packages – and, in the case of the Caddy panel van, with big load bays. You'll be amazed by how much you can carry

**F**or a van that's less than 4.5m in length, there's an awful lot you can cram into the back of a Caddy panel van. Thanks to a host of loading options and accessories that make it even more versatile, you can also carefully tailor the panel van to suit your needs.

### Easy to load, plenty of room

The Caddy is definitely the panel van about town, thanks to a generous payload and load volume that you'd simply never expect in a vehicle this compact. You can fit up to 3.2m<sup>3</sup> of cargo in the back and loads up to 1.78m long, and it's all easy to secure, thanks to six load-lashing rings. A floor height of just 576mm makes getting things in or out really easy, too, while a full-height bulkhead keeps you safe from loose items. With a sliding-side-door aperture that's 70cm wide and asymmetric rear doors, great access to your load is assured, too.

### More loading options

If you want greater flexibility for accessing your cargo, you can add an extra sliding side door. This lets you access the rear of your van from either side, so you can park on any side of the street for easy loading.

You can also change the twin rear doors for a tailgate with a heated rear window and wash-wipe system, or rear wing doors with opaque glazing. This hides the contents of your van, which adds another useful level of security.



### Sizing your load

An average washing machine will occupy about 0.25m<sup>3</sup> of your Caddy's load volume and weighs about 70kg



A range of door options – including the standard glazed asymmetric rear wing doors – make loading and unloading easy





Caddy Maxi panel van

# More room to work

The longer-wheelbase Caddy Maxi offers all the same superb benefits as the standard Caddy, but has more cargo space for even greater capacity

If you need something a bit bigger than a standard Caddy panel van, the long-wheelbase Caddy Maxi offers all of the Caddy's practical benefits – the same terrific low floor for easy loading, and lots of load-lashing rings – but adds even more space for good measure, helping you work more efficiently.

The Caddy Maxi has an extra cubic metre of load space over the Caddy panel van, (bringing it up to 4.2m<sup>3</sup>), and has a load length of 2.25m – almost half a metre longer than the standard panel van.

The Caddy Maxi includes a sliding door on each side as standard, letting you access your load from

each side. You can also opt for a tailgate instead of the twin asymmetric rear doors if you wish, too.

And, just like the Caddy panel van, you can make full use of the streamlined roof-rail channels by specifying a set of Volkswagen load bars, vastly increasing the variety of loads you can carry.

Caddy Maxi kombi

# Cargo + crew = kombi

Need a small van that can shift workmates as well as the kit you need to do the job? Enter the Caddy Maxi kombi – a truly flexible compact van



Sometimes you need to carry more than goods – sometimes you have to take workmates to jobs, too. Enter the Caddy Maxi kombi – a versatile vehicle that will do both with ease. You can load it to suit your changing needs.

With the rear seats in place, you can carry five people and still have enough room for 1.6m<sup>3</sup> of cargo. Fold the rear seats and you'll increase the load space to 3.9m<sup>3</sup>, or remove them altogether and you'll have 4.1m<sup>3</sup> – that's only a fraction less than the regular Caddy Maxi panel van. The Caddy Maxi kombi also comes with twin glazed side doors and glazed tailgate for superb access.

### Configured to your needs

Whether you're after roof bars or towing options to increase your load-carrying capacity, a durable load-floor covering or load lashing and storage options, we've got a whole range of factory-fit options, helping to ensure that your Caddy Maxi kombi is versatile enough to meet your every challenge.



# Trimlines

Even more features  
for your van, for  
one great price

## More kit, better value

Startline, Trendline and Highline:  
add options to your van in an easy,  
cost-effective way

**T**rimlines combine our most popular factory-fit options in one easy-fit pack, for one value-added price. This means that choosing a trimline is more cost-effective than buying the same options separately. The result: a feature-packed van that delivers more for your business every day, with better resale value in the long-term.

The range of Caddy trimlines begins with the already well-equipped Startline. You can add more comfort and convenience by upgrading to Trendline, while Highline is our most feature-packed trimline, offering excellent value for money at an affordable price.

You can add trimlines to any Caddy panel van and combine them with BlueMotion Technology to save even more with Volkswagen's most fuel-efficient engines yet. And, if you want to add more options, feel free. Your Van Centre can help you pick what's right for you.



STARTLINE, TRENDLINE AND HIGHLINE

### Trendline

Add extra style with body-coloured bumpers, door handles and door mirrors, as well as special wheel trims.

Inside the cab, the addition of electric windows, extra storage compartments, and sunvisors with vanity mirrors, all add extra style and convenience.

Rear parking sensors help you get into tight spaces with ease, while the RCD 310 CD/radio with aux-in for external devices makes journeys even more enjoyable.

In addition, cruise control and Bluetooth® phone connectivity means the road gets your undivided attention.



### Highline

All the features of Trendline, and more for good measure. Kemora or Siracusa alloy wheels make sure you look the business, while Climatic air-conditioning and a leather-covered steering wheel and gearknob add the cool in the cab.

Front fog lights show you the way, while a Thatcham Category 1 alarm and immobiliser give you peace of mind when you're away from your vehicle.





# Features and prices

One simple route to your perfect van

## Caddy panel van: **Startline features**

### Startline

#### Exterior

15" steel wheels with 195/65 R15 tyres and black centre caps

16" steel wheels with 205/55 R16 tyres and black centre caps (140PS models)

60-litre fuel tank

Glazed asymmetric rear wing doors with heated rear window and wash/wipe (not C20+)

Grey bumpers

Roof-rack preparation

Full-size steel spare wheel

Passenger-side sliding door

#### Interior

##### Cab area:

RCD 210 radio/single CD player with two speakers and aux-in socket

Manually controlled heating system with dust and pollen filter and air recirculation

Servotronic speed-related power-assisted steering

Reach- and rake-adjustable steering column

12V socket in dashboard

Interior light in headliner

Open glove compartment

Four drinks holders and storage compartment in centre console

Digital clock

Dimmable dashboard illumination

Rear-view mirror with anti-dazzle function (not C20+)

Driver's seat with height, reach and rake adjustment and passenger seat with reach and rake adjustment

Austin cloth upholstery

##### Cargo area:

Full height bulkhead – solid lower and plastic mesh upper (solid bulkhead on C20+ models)

Hardboard roof trim and painted half-height side panels

Two door-activated interior lights

Six load-lashing rings

Rubber floor covering

#### Safety and security

Automatic hazard light activation under emergency braking

Driver's airbag

Electronic Stabilisation Programme (ESP)

Anti-lock Brake System (ABS)

Electronic Differential Lock (EDL)

Traction Control System (TCS)

Engine Drag Torque Control (MSR)

Electronic Brakeforce Distribution (EBD)

Halogen main headlights with range control and daytime running lights

Jack and tool kit

Remote central locking with deadlocks, internal locking switch and two remote keys

Thatcham Category 2 immobiliser

Windscreen wiper with variable intermittent delay and wash/wipe system

#### Model-specific features

##### C20+

Full height bulkhead – solid

Heavy-duty suspension

Asymmetric rear wing doors with opaque glass



### Rear wing doors with heated rear window and wash/wipe

The Caddy panel van is fitted with glazed asymmetric rear wing doors as standard. You can replace the wing doors with a tailgate as a no-cost factory-fitted option if you wish.



### RCD 210 radio/CD player

The RCD 210 includes an AM/FM radio and MP3 file-compatible CD player, and comes with two 20W speakers in the cab. You can upgrade your audio, or add phone connectivity or a sat-nav from our factory-fit options section.



### Passenger-side sliding door

The Caddy panel van has a passenger-side sliding door fitted as standard. You can add a driver-side door as a factory-fit option to let you load the vehicle from either side.



### Roof-rack preparation

Compact vans aren't limited to the cargo they can carry in the back. The Caddy comes with roof rack connections as standard. You can get a variety of roof-storage solutions as part of our Add Ons range. Ask your Van Centre for details.



### Full-height bulkhead

To separate the load area from the cab, every Caddy panel van has a full-height bulkhead. On most models, this has a plastic mesh upper for clear through-vision. On C20+ models it's a full solid bulkhead for greater security.



### Safety features: as standard

The Caddy comes with a driver airbag, as well as Electronic Stabilisation Programme (ESP), Anti-lock Braking System (ABS) and Electronic Brakeforce Distribution (EBD). Hill Hold Assist is available as a factory-fit option.



### Cargo area

The rear of the Caddy panel van is packed with features to make work easy: two door-activated interior lights, half-height side panels and hardboard roof trim to protect your vehicle, and six load-lashing rings.



### In-cab storage solutions

Vans don't just carry loads in the rear – the cab carries all the clutter that fills your working day. Luckily, there are lots of clever storage solutions in the Caddy, including four drinks holders.

### How to choose your Caddy panel van

p22 Pick a Startline model/engine

p23 Add BlueMotion Technology to enjoy even greater fuel savings

p24 Add Trendline or Highline to get our top options at one value-added price

p36 Choose any extra factory-fit options that you need





## Caddy panel van: **Startline prices**



*Finance that makes buying a Volkswagen even more affordable*

Our extensive range of finance packages can make driving a Volkswagen Caddy a reality. Ask your Van Centre for a Business Finance brochure and speak to us today – you may be surprised at how much you can afford.

Every Caddy has an On The Road package that covers basic vehicle costs

| On The Road (OTR) package     |                |
|-------------------------------|----------------|
| First registration fee        | £55.00         |
| Delivery to Van Centre        | £565.00        |
| VAT                           | £117.00        |
| Vehicle Excise Duty (1 year)* | £220.00        |
| Number plates                 | £20.00         |
| <b>Basic OTR (ex VAT)</b>     | <b>£860.00</b> |
| <b>Total OTR price</b>        | <b>£977.00</b> |

| Model       | Engine/transmission | Basic (ex VAT)    | Total (inc VAT) | Total RRP including OTR* (ex VAT) | Total RRP including OTR* (inc VAT) |
|-------------|---------------------|-------------------|-----------------|-----------------------------------|------------------------------------|
| <b>C20</b>  | 1.6TDI 75PS         | <b>£13,080.00</b> | £15,696.00      | £13,940.00                        | <b>£16,673.00</b>                  |
|             | 1.6TDI 102PS        | <b>£13,790.00</b> | £16,548.00      | £14,650.00                        | <b>£17,525.00</b>                  |
|             | 1.6TDI 102PS DSG    | <b>£15,090.00</b> | £18,108.00      | £15,950.00                        | <b>£19,085.00</b>                  |
|             | 2.0TDI 140PS        | <b>£15,710.00</b> | £18,852.00      | £16,570.00                        | <b>£19,829.00</b>                  |
|             | 2.0TDI 140PS DSG    | <b>£17,010.00</b> | £20,412.00      | £17,870.00                        | <b>£21,389.00</b>                  |
| <b>C20+</b> | 1.6TDI 75PS         | <b>£13,185.00</b> | £15,822.00      | £14,045.00                        | <b>£16,799.00</b>                  |
|             | 1.6TDI 102PS        | <b>£13,895.00</b> | £16,674.00      | £14,755.00                        | <b>£17,651.00</b>                  |

\* For full details of VED (Vehicle Excise Duty) bands and other costs included in the On The Road package, please ask your Van Centre.

## Caddy panel van: **BlueMotion Technology**

### BlueMotion Technology

Technology that dramatically improves the fuel efficiency of your van and lowers its emissions, cutting your fuel bills and your impact on the environment. It can be added to any of the Caddy trimlines: Startline, Trendline and Highline



#### Start/stop

Helps you to save fuel in slow traffic and at traffic lights by cutting the engine. When you're ready to get going again, the engine automatically restarts.

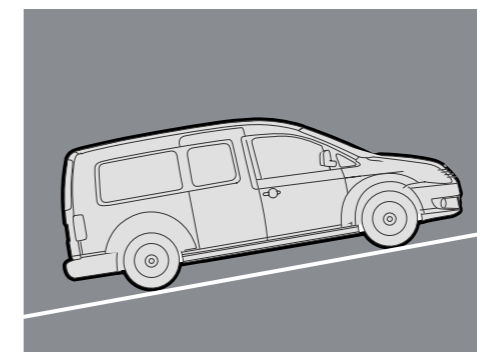

#### Hill Hold Assist

Helps you make an efficient getaway every time. On steep inclines it briefly keeps the brakes on to prevent you rolling back. This reduces the need to rev the engine unnecessarily.



#### Cruise control

By keeping your van at a constant speed for long stretches of open road, cruise control saves fuel that would normally be wasted when your speed fluctuates.



#### Energy recuperation

Energy recuperation uses your momentum during deceleration to run the alternator and charge the battery. That means the engine needs to do less work at other times.



#### BlueMotion Technology badge

By carrying the BlueMotion Technology badge, you show that your business ensures its vehicles keep their impact on the environment to a minimum.



Add the BlueMotion Technology price to the standard price of any Caddy panel van

| BlueMotion Technology price |                |
|-----------------------------|----------------|
| Basic (ex VAT)              | £405.00        |
| <b>Total RRP (inc VAT)</b>  | <b>£486.00</b> |





# Caddy panel van: Trendline & Highline



## Trendline

A selection of our most popular factory-fit options in one easy-fit pack for one single value-added price, bringing you significant savings over buying each of these options individually. You can also combine trimlines with BlueMotion Technology for even greater long-term savings



### Body-coloured bumpers, mirrors and door handles

A great way to add extra style to your Caddy panel van. The Trendline also includes special wheel trims for that classy finishing touch.



### RCD 310 radio/CD with aux-in

Adds two extra speakers (four in total), an MP3 compatible CD player, an aux-in for external devices and the ability to add Digital Audio Broadcast (DAB) radio as a factory-fit option.



### Electrically adjustable door mirrors and front windows

Make day-to-day driving even easier with electrically heated and adjustable door mirrors, as well as electric front windows.

### Also included in the Trendline trim

Bluetooth® mobile phone connection. Includes a trip computer with multi-function display

Storage compartments under the front seats, sunvisors with vanity mirrors, and dashboard centre storage compartment cover

Height adjustment for the passenger seat (standard for driver's seat)



### Cruise control

By keeping your vehicle at a constant speed for long stretches of open road, cruise control saves fuel that would normally be wasted when your speed fluctuates.



### Rear parking sensors

You can see a lot using the Caddy's large wing mirrors, but city obstacles such as bollards are often hiding out of view. Rear parking sensors will help alert you to these hidden hazards.

### Upgrade any Caddy panel van from Startline to Trendline in one easy step

| Trendline price (panel van) |           |
|-----------------------------|-----------|
| Basic (ex vat)              | £1,000.00 |
| Total RRP (inc vat)         | £1,200.00 |

### The savings you make (ex vat)

|                 |           |
|-----------------|-----------|
| What it's worth | £1,580.00 |
| What you pay    | £1,000.00 |
| What you save   | £580.00   |

## Highline

All of the factory-fit options included in the Trendline (see page left), with even more style and functionality added for good measure. As with the Trendline, buying these options in one pack means you'll make considerable savings over buying them separately



### 15" Kemora alloy

Set of four 6J x 15 Kemora alloy wheels with 195/65 R15 tyres. Includes steel spare wheel. (Not compatible with 140PS engines).



### 16" Siracusa alloy (on 140PS)

Set of four 6J x 16 Siracusa alloy wheels with 205/55 R16 tyres. Includes steel spare wheel.



### Leather-covered steering wheel, gearknob and gaiter

Add an extra dose of luxury feel to the interior of your Caddy panel van.

### Also included in the Highline trim

Thatcham Category 1 alarm and immobiliser with perimeter, cab and tow-away protection



### Climatic air-conditioning

Make sure that you and your passengers are always at the right temperature – warm on winter days and cool in the heat of summer.



### Front fog lights with cornering function

Get an even better view of the road ahead, particularly in low-light conditions, and add an extra dash of style to your van's front-end.

### Upgrade any Caddy panel van from Startline to Highline in one easy step

| Highline price (panel van) |           |
|----------------------------|-----------|
| Basic (ex vat)             | £2,000.00 |
| Total RRP (inc vat)        | £2,400.00 |

### The savings you make (ex vat)

|                 |           |
|-----------------|-----------|
| What it's worth | £3,350.00 |
| What you pay    | £2,000.00 |
| What you save   | £1,350.00 |





# Caddy Maxi panel van: **Startline** features



## Startline

### Exterior

- 60-litre fuel tank
- Grey bumpers
- 15" steel wheels with 195/65 R15 tyres and black centre caps
- 16" steel wheels with 205/55 R16 tyres and black centre caps (140PS engines)
- Opaque asymmetric rear-wing doors
- Roof rack preparation
- Full-size steel spare wheel (except 4MOTION® models, which have Tyre Mobility System)
- Sliding doors on driver and passenger sides

### Interior

- Cab area:**
- RCD 210 radio/single MP3-compatible CD player with two speakers and aux-in socket
  - Manually controlled heating system with dust and pollen filter and air recirculation
  - Servotronic speed-related power-assisted steering
  - Height- and rake-adjustable steering column
  - 12V socket in dashboard
  - Two door-activated interior lights
  - Open glove compartment
  - Four drinks holders and storage compartment in centre console
  - Digital clock
  - Dimmable dashboard illumination
  - Interior light in headliner
  - Driver seat with height, reach and rake adjustment and passenger seat with reach and rake adjustment
  - Austin cloth upholstery
- Cargo area:**
- Solid full-height bulkhead
  - Six load-lashing rings
  - Hardboard roof trim and painted half-height side panels
  - Rubber floor covering

### Safety and security

- Automatic hazard lights activation under emergency braking
- Driver's airbag
- Electronic Stabilisation Programme (ESP)
- Anti-lock Brake System (ABS)
- Electronic Differential Lock (EDL)
- Traction Control System (TCS)
- Engine Drag Torque Control (MSR)
- Electronic Brakeforce Distribution (EBD)
- Halogen main headlights with range control and daytime running lights
- Jack (except 110PS 4MOTION®) and tool kit
- Remote central locking with deadlocks, internal locking switch and two remote keys
- Thatcham Category 2 immobiliser
- Windscreen wiper with variable intermittent delay and wash/wipe system

## How to choose your Caddy Maxi panel van

- p28 **Pick a Startline model/engine**
- p29 **Add BlueMotion Technology to enjoy even greater fuel savings**
- p30 **Add Trendline or Highline to get our top options at one value-added price**
- p36 **Choose any extra factory-fit options that you need**



### Rear wing doors

The Caddy Maxi panel van is fitted with rear wing doors as standard. You can choose to replace the wing doors with a tailgate as a factory-fit option if you wish.



### RCD 210 radio/CD player

The RCD 210 includes an AM/FM radio and MP3 file-compatible CD player, and comes with two 20W speakers in the cab. You can upgrade your audio, or add phone connectivity or a sat-nav, from our factory-fit options section.



### Sliding doors on both the driver and passenger side

The Caddy Maxi panel van has sliding doors fitted on both sides of the vehicle as standard. This lets you load the vehicle from either side.



### Roof rack preparation

Compact vans aren't limited to the cargo they can carry in the back. The Caddy Maxi comes with roof rack connections as standard. You can get a variety of roof-storage solutions as part of our Add Ons range. Ask your Van Centre for details.



### Full-height bulkhead

To separate the load area from the cab, every Caddy Maxi panel van has a full-height solid bulkhead fitted as standard.



### Safety features: as standard

Caddy Maxi comes with a driver airbag, as well as Electronic Stabilisation Programme (ESP), Anti-lock Braking System (ABS) and Electronic Brakeforce Distribution (EBD). Hill Hold Assist is available as a factory-fit option.



### Cargo area

The rear of the Caddy Maxi panel van is packed with features to make work easy: two door-activated interior lights, painted half-height side panels and hardboard roof trim to protect your vehicle, and six load-lashing rings.



### In-cab storage solutions

Vans don't just carry loads in the rear – the cab carries all the clutter that fills your working day. Luckily, there are lots of clever storage solutions in the Caddy Maxi, including four drinks holders.





## Caddy Maxi panel van: Prices



Finance that makes buying a Volkswagen even more affordable

Our range of finance packages can make driving a Volkswagen Caddy Maxi a reality. Ask your Van Centre for a Business Finance brochure or talk to us today – you may be surprised at how much you can afford.

Every Caddy has an On The Road package that covers basic vehicle costs

| On The Road (OTR) package     |                |
|-------------------------------|----------------|
| First registration fee        | £55.00         |
| Delivery to Van Centre        | £565.00        |
| VAT                           | £117.00        |
| Vehicle Excise Duty (1 year)* | £220.00        |
| Number plates                 | £20.00         |
| <b>Basic OTR (ex VAT)</b>     | <b>£860.00</b> |
| <b>Total OTR price</b>        | <b>£977.00</b> |

| Model      | Engine/transmission   | Basic (ex VAT)    | Total (inc VAT) | Total RRP including OTR* (ex VAT) | Total RRP including OTR* (inc VAT) |
|------------|-----------------------|-------------------|-----------------|-----------------------------------|------------------------------------|
| <b>C20</b> | 1.6TDI 102PS          | <b>£15,065.00</b> | £18,078.00      | £15,925.00                        | <b>£19,055.00</b>                  |
|            | 1.6TDI 102PS DSG      | <b>£16,365.00</b> | £19,638.00      | £17,225.00                        | <b>£20,615.00</b>                  |
|            | 2.0TDI 140PS          | <b>£16,985.00</b> | £20,382.00      | £17,845.00                        | <b>£21,359.00</b>                  |
|            | 2.0TDI 140PS DSG      | <b>£18,285.00</b> | £21,942.00      | £19,145.00                        | <b>£22,919.00</b>                  |
|            | 2.0TDI 110PS 4MOTION® | <b>£18,065.00</b> | £21,678.00      | £18,925.00                        | <b>£22,655.00</b>                  |

\* For full details of VED (Vehicle Excise Duty) bands and other costs included in the On The Road package, please ask your Van Centre.

## Caddy Maxi panel van: BlueMotion Technology



### BlueMotion Technology

Technology that dramatically improves the fuel efficiency of your van and lowers its emissions, cutting your fuel bills and your impact on the environment. It can be added to any of the Caddy trimlines: Startline, Trendline and Highline



#### Start/stop

Helps you to save fuel in slow traffic and at traffic lights by cutting the engine. When you're ready to get going again, the engine automatically restarts.

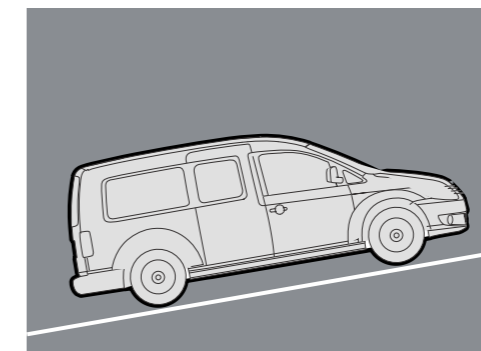

#### Hill Hold Assist

Helps you make an efficient getaway every time. On steep inclines it briefly keeps the brakes on to prevent you rolling back. This reduces the need to rev the engine unnecessarily.



#### Cruise control

By keeping your van at a constant speed for long stretches of open road, cruise control saves fuel that would normally be wasted when your speed fluctuates.



#### Energy recuperation

Energy recuperation uses your momentum during deceleration to run the alternator and charge the battery. That means the engine needs to do less work at other times.



#### BlueMotion Technology badge

By carrying the BlueMotion Technology badge, you show that your business ensures its vehicles keep their impact on the environment to a minimum.



Add the BlueMotion Technology price to the standard price of any Caddy Maxi panel van

| BlueMotion Technology price |                |
|-----------------------------|----------------|
| Basic (ex VAT)              | £405.00        |
| <b>Total RRP (inc VAT)</b>  | <b>£486.00</b> |





# Caddy Maxi panel van: **Trimlines**



## Trendline

A selection of our most popular factory-fit options in one easy-fit pack for one single value-added price, bringing you significant savings over buying each of these options individually. You can also combine trimlines with BlueMotion Technology for even greater long-term savings



### Body-coloured bumpers, mirrors and door handles

A great way to add extra style to your Caddy Maxi panel van. The Trendline also includes special wheel trims for that classy finishing touch



### RCD 310 radio/CD with aux-in

Adds two extra speakers (four in total), an MP3 compatible CD player, an aux-in for external devices and the ability to add Digital Audio Broadcast (DAB) radio as a factory-fit option.



### Electrically adjustable door mirrors and front windows

Make day-to-day driving even easier with electrically heated and adjustable door mirrors, as well as electric front windows.

## Also included in the Trendline trim

Bluetooth® mobile phone connection. Includes a trip computer with multi-function display

Storage compartments under the front seats, sunvisors with vanity mirrors and dashboard centre storage compartment cover

Height adjustment for the passenger seat (standard for driver's seat)



### Cruise control

By keeping your vehicle at a constant speed for long stretches of road, cruise control saves fuel that would normally be wasted when your speed fluctuates.



### Rear parking sensors

You can see a lot using the Caddy Maxi's large wing mirrors, but city obstacles such as bollards are often hiding out of view. Parking sensors will help alert you to these hidden hazards.

## Upgrade any Caddy Maxi panel van from Startline to Trendline in one easy step

| Trendline price (panel van) |           |
|-----------------------------|-----------|
| Basic (ex vat)              | £1,000.00 |
| Total RRP (inc vat)         | £1,200.00 |

| The savings you make (ex vat) |           |
|-------------------------------|-----------|
| What it's worth               | £1,580.00 |
| What you pay                  | £1,000.00 |
| What you save                 | £580.00   |

## Highline

All of the factory-fit options included in the Trendline (see page left), with even more style and functionality added for good measure. As with the Trendline, buying these options in one pack means you'll make considerable savings over buying them separately



### 15" Kemora alloy

Set of four 6J x 15 Kemora alloy wheels with 195/65 R15 tyres. Includes steel spare wheel. (Not compatible with 140PS engines).



### 16" Siracusa alloy (on 140PS)

Set of four 6J x 16 Siracusa alloy wheels with 205/55 R16 tyres. Includes steel spare wheel.



### Leather-covered steering wheel, gearknob and gaiter

Add an extra dose of luxury feel to the interior of your Caddy panel van.



### Climatic air-conditioning

Make sure that you and your passengers are always at the right temperature – warm on winter days and cool in the heat of summer.



### Front fog lights with cornering function

Get an even better view of the road ahead, particularly in low-light conditions, and add an extra dash of style to your van's front-end.

## Also included in the Highline trim

Thatcham Category 1 alarm and immobiliser with perimeter, cab and tow-away protection

## Upgrade any Caddy panel van from Startline to Highline in one easy step

| Highline price (panel van) |           |
|----------------------------|-----------|
| Basic (ex vat)             | £2,000.00 |
| Total RRP (inc vat)        | £2,400.00 |

| The savings you make (ex vat) |           |
|-------------------------------|-----------|
| What it's worth               | £3,350.00 |
| What you pay                  | £2,000.00 |
| What you save                 | £1,350.00 |





# Caddy Maxi kombi: Standard features



## Exterior

- 60-litre fuel tank
- Grey bumpers
- 15" steel wheels with 195/65 R15 tyres and black centre caps
- Spare wheel – full-size steel
- Glazed tailgate with heated rear window and wash/wipe
- Roof-rack preparation
- Sliding side doors on driver and passenger side with fixed windows

## Interior

- Cab area**
- RCD 210 radio/single MP3-compatible CD player with two speakers and aux-in socket
  - Manually controlled heating system with dust and pollen filter and air recirculation
  - Height and rake adjustable steering column
  - Servotronic speed-related power-assisted steering
  - 12V socket in dashboard
  - Interior light in headliner
  - Open glove compartment
  - Four drinks holders and storage area in centre console
  - Digital clock
  - Dimmable dashboard illumination
  - Driver's seat with height, reach and rake adjustment and passenger seat with reach and rake adjustment
  - Three-seater split/folding and removable bench in the first passenger row, with ISOFIX mountings in outer seats
  - Austin cloth upholstery
- Cargo area**
- Hardboard roof trim and side panels in rear passenger compartment
  - Six load-lashing rings
  - Solid rear side panels
  - Rubber floor covering

## Safety and security

- Automatic hazard lights activation under emergency braking
- Driver and front passenger airbags with front passenger deactivation switch
- Electronic Stabilisation Programme (ESP)
- Anti-lock Brake System (ABS)
- Electronic Differential Lock (EDL)
- Traction Control System (TCS)
- Engine Drag Torque Control (MSR)
- Electronic Brakeforce Distribution (EBD)
- Halogen main headlights with range control and daytime running lights
- Jack and tool kit
- Remote central locking with deadlocks, internal locking switch and one remote key
- Thatcham Category 2 immobiliser
- Windscreen wiper with variable intermittent delay and wash/wipe system



### Glazed tailgate

The Caddy Maxi kombi's tailgate comes with a heated rear window and wash/wipe.



### RCD 210 radio/CD player

The RCD 210 includes an AM/FM radio and MP3 file-compatible CD player, and comes with two 20W speakers in the cab. You can upgrade your audio, or add phone connectivity or a sat-nav, from our factory-fit options section.



### Sliding doors on both the driver and passenger side

The Caddy Maxi kombi has sliding doors fitted on both sides of the vehicle as standard. This lets passengers get in from either side.



### Roof rack preparation

Compact vans aren't limited to the cargo they can carry inside. The Caddy Maxi kombi comes with roof rack connections as standard. You can get a variety of roof-storage solutions as part of our Add Ons range. Ask your Van Centre for details.



### Hardboard interior roof trim and side panels

The standard-fit wood-trim cargo bay interior will protect both your Caddy Maxi kombi and your load from everyday wear and tear.



### Safety features: as standard

The Caddy Maxi kombi comes with a driver and passenger airbag, Electronic Stabilisation Programme (ESP), Anti-lock Braking System (ABS) and Electronic Brakeforce Distribution (EBD). Hill Hold Assist is available as a factory-fit option.



### Cargo area

The rear of the Caddy Maxi kombi is packed with features to make work easy: two door-activated interior lights, half-height side panels and hardboard roof trim to protect your vehicle and six load-lashing rings.



### In-cab storage solutions

Vans don't just load in the rear – the cab stores the clutter that fills your working day. And there are lots of clever storage solutions in the Caddy Maxi kombi, including four drinks holders.

## How to choose your Caddy Maxi kombi

p34 Pick a Startline model/engine

p36 Choose any extra factory-fit options that you need





## Caddy Maxi kombi: Prices



*Finance that makes buying a Volkswagen even more affordable*

Our extensive range of finance packages can make driving a Volkswagen Caddy Maxi a reality. Ask your Van Centre for a Business Finance brochure and speak to us today – you may be surprised at how much you can afford.

Every Caddy has an On The Road package that covers basic vehicle costs

| On The Road (OTR) package     |                |
|-------------------------------|----------------|
| First registration fee        | £55.00         |
| Delivery to Van Centre        | £565.00        |
| VAT                           | £117.00        |
| Vehicle Excise Duty (1 year)* | £220.00        |
| Number plates                 | £20.00         |
| <b>Basic OTR (ex VAT)</b>     | <b>£860.00</b> |
| <b>Total OTR price</b>        | <b>£977.00</b> |

| Model      | Engine/transmission | Basic (ex VAT)    | Total (inc VAT) | Total RRP including OTR* (ex VAT) | Total RRP including OTR* (inc VAT) |
|------------|---------------------|-------------------|-----------------|-----------------------------------|------------------------------------|
| <b>C20</b> | 1.6TDI 102PS        | <b>£15,470.00</b> | £18,564.00      | £16,330.00                        | <b>£19,541.00</b>                  |
|            | 1.6TDI 102PS DSG    | <b>£16,770.00</b> | £20,124.00      | £17,630.00                        | <b>£21,101.00</b>                  |

\* For full details of VED (Vehicle Excise Duty) bands and other costs included in the On The Road package, please ask your Van Centre.







# Options

Get the best from your Caddy with our quality options



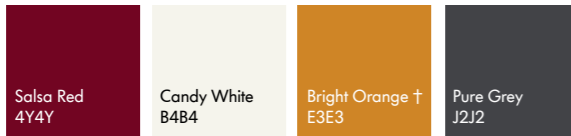

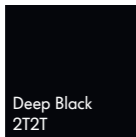
## Paint

You want your Caddy – and your business – to make an impression. The most striking way to do that is to opt for a distinctive paint finish.

|   | Paint Options  | Startline      |                     | Trendline      |                     | Highline       |                     |
|---|--|----------------|---------------------|----------------|---------------------|----------------|---------------------|
|   |  | Basic (ex VAT) | Total RRP (inc VAT) | Basic (ex VAT) | Total RRP (inc VAT) | Basic (ex VAT) | Total RRP (inc VAT) |
| <b>Standard</b><br>A great range of colours, available at no extra cost   |   | ○              | ○                   | ○              | ○                   | ○              | ○                   |
| <b>Metallic paints</b><br>Mark out your van and your business from the competition with a smart metallic paint finish |  | £375.00        | £450.00             | £375.00        | £450.00             | £375.00        | £450.00             |
| <b>Pearlescent paints</b><br>Tiny flecks of material in the paint reflect light, giving your vehicle a unique look    |  | £375.00        | £450.00             | £375.00        | £450.00             | £375.00        | £450.00             |

## Options: Alloy wheels and tyres

Complete your Caddy's sleek, sharp look with a set of stylish alloy wheels

|   | Image  | Engine                                      | Startline                         |                                     | Trendline                         |                                   | Highline                      |                               |
|---|--|---|-----------------------------------|-------------------------------------|-----------------------------------|-----------------------------------|-------------------------------|-------------------------------|
|   |  |   | Basic (ex VAT)                    | Total RRP (inc VAT)                 | Basic (ex VAT)                    | Total RRP (inc VAT)               | Basic (ex VAT)                | Total RRP (inc VAT)           |
| <b>15" Kemora</b><br>Four 6J x 15 alloys with steel spare and 195/65 R15 tyres. Available for panel van, Maxi panel van and Maxi kombi    |      | 2.0TDI 75PS<br>2.0TDI 102PS<br>2.0TDI 140PS | £480.00<br>£480.00<br>–           | £576.00<br>£576.00<br>–             | £470.00<br>£470.00<br>–           | £564.00<br>£564.00<br>–           | S<br>S<br>–                   | S<br>S<br>–                   |
| <b>16" Sacramento*</b><br>Four 6J x 16 alloys with 205/55 R16 tyres, alloy covers and 16" chassis   |  | 2.0TDI 75PS<br>2.0TDI 102PS<br>2.0TDI 140PS | £805.00<br>£805.00<br>£475.00     | £966.00<br>£966.00<br>£570.00       | £775.00<br>£775.00<br>£455.00     | £930.00<br>£930.00<br>£546.00     | £325.00<br>£325.00<br>○       | £390.00<br>£390.00<br>○       |
| <b>16" Siracusa*†</b><br>Four 6J x 16 alloys with 205/55 R16 tyres and steel spare  |    | 2.0TDI 75PS<br>2.0TDI 102PS<br>2.0TDI 140PS | £805.00<br>£805.00<br>£475.00     | £966.00<br>£966.00<br>£570.00       | £775.00<br>£775.00<br>£455.00     | £930.00<br>£930.00<br>£546.00     | £560.00<br>£560.00<br>S       | £672.00<br>£672.00<br>S       |
| <b>17" Budapest*†</b><br>Four 6J x 17 alloys with 205/150 R17 tyres, alloy covers and 16" chassis. Requires alloy spare or breakdown set. |    | 2.0TDI 75PS<br>2.0TDI 102PS<br>2.0TDI 140PS | £1,130.00<br>£1,130.00<br>£815.00 | £1,356.00<br>£1,356.00<br>£978.00   | £1,095.00<br>£1,095.00<br>£785.00 | £1,314.00<br>£1,314.00<br>£942.00 | £645.00<br>£645.00<br>£560.00 | £774.00<br>£774.00<br>£672.00 |
| <b>17" Canyon*†</b><br>Four 6J x 17 alloys with 205/150 R17 tyres. Requires alloy spare or breakdown set                                  |      | 2.0TDI 75PS<br>2.0TDI 102PS<br>2.0TDI 140PS | £1,185.00<br>£1,185.00<br>£870.00 | £1,422.00<br>£1,422.00<br>£1,044.00 | £1,115.00<br>£1,115.00<br>£810.00 | £1,338.00<br>£1,338.00<br>£972.00 | £735.00<br>£735.00<br>£710.00 | £882.00<br>£882.00<br>£852.00 |
| <b>17" alloy spare wheel</b><br>Requires 17" alloys. Not available with BlueMotion Technology   |  |   | £170.00                           | £204.00                             | £170.00                           | £204.00                           | £170.00                       | £204.00                       |
| <b>Breakdown set</b><br>12V compressor and tyre sealant. Replaces spare wheel.  |  |   | ○                                 | ○                                   | ○                                 | ○                                 | ○                             | ○                             |
| <b>Locking wheel bolts</b>  |  |   | £15.00                            | £18.00                              | £15.00                            | £18.00                            | £15.00                        | £18.00                        |
| <b>Hub caps</b>   |  |   | £60.00                            | £72.00                              | S                                 | S                                 | –                             | –                             |
| <b>Tyres</b>  |  |   |                                   |                                     |                                   |                                   |                               |                               |
| <b>All-weather tyres</b><br>Ask your Van Centre for the right tyres for your vehicle  |  |   | £95.00 to £130.00                 | £114.00 to £156.00                  | £95.00 to £130.00                 | £114.00 to £156.00                | £95.00 to £130.00             | £114.00 to £156.00            |
| <b>Winter tyres</b><br>Ask your Van Centre for the right tyres for your vehicle   |  |   | £130.00                           | £156.00                             | £130.00                           | £156.00                           | £130.00                       | £156.00                       |



Keep your alloys in perfect condition

Brake dust is full of abrasive and corrosive metal and carbon particles, so clean your alloys every couple of weeks with a specialist brush and cleaning fluid, then coat them with a wax protector. You can buy these at your local Van Centre.







If you want even more choice for alloy wheels check out our Add Ons accessories range. Ask your local Van Centre for a brochure, call 0800 717131 or download a copy at [www.volkswagen-vans.co.uk](http://www.volkswagen-vans.co.uk)



# Options: Audio, phone and satellite-navigation

Choose from a range of entertainment systems for great music on the go, or opt for one of our touch-screen satellite-navigation systems

|  |   |   | Startline  |   | Trendline                     |                               | Highline                |                         |                         |
|--|---|---|--|---|-------------------------------|-------------------------------|-------------------------|-------------------------|-------------------------|
|  |   |   | Basic (ex VAT)   | Total RRP (inc VAT)                       | Basic (ex VAT)                | Total RRP (inc VAT)           | Basic (ex VAT)          | Total RRP (inc VAT)     |                         |
| <b>Audio</b>   |   |   |  |   |                               |                               |                         |                         |                         |
| <b>RCD 210</b>   |    | A great basic system for music on the go. Listen to the radio or play your own music on the CD player or via the aux-in                               | ✓ Two speakers<br>✓ FM/AM radio<br>✓ Single CD player<br>✓ Aux-in for external devices   | All models                                | S                             | S                             | -                       | -                       | -                       |
| <b>RCD 310</b>   |   | This radio includes two speakers, an aux-in for external devices and the option of adding Digital Audio Broadcast (DAB) radio                         | ✓ Two speakers<br>✓ FM/AM radio<br>✓ Optional DAB (see below)<br>✓ Single CD player<br>✓ Aux-in for external devices   | Panel van<br>Maxi panel van<br>Maxi kombi | £135.00<br>£135.00<br>£135.00 | £162.00<br>£162.00<br>£162.00 | S<br>S<br>-             | S<br>S<br>-             | S<br>S<br>-             |
| <b>RCD 510</b>   |  | This radio includes a 6.5" colour touch-screen, a six-CD changer, an aux-in and an SD memory card slot. You can also choose to add optional DAB radio | ✓ 6.5" colour touch-screen<br>✓ Four speakers<br>✓ FM/AM radio<br>✓ SD memory card slot<br>✓ Optional DAB (see below)<br>✓ Six-CD changer<br>✓ Aux-in for external devices | Panel van<br>Maxi panel van<br>Maxi kombi | £370.00<br>£370.00<br>£370.00 | £444.00<br>£444.00<br>£444.00 | £240.00<br>£240.00<br>- | £288.00<br>£288.00<br>- | £240.00<br>£240.00<br>- |
| <b>DAB+ - digital audio reception for RCD 310 / RCD510</b> |   | Digital Audio Broadcasting (DAB) offers more stations, a clearer signal and information about what's playing  |  | All models                                | £145.00                       | £174.00                       | £145.00                 | £174.00                 | £145.00                 |

|                                      |  |  | Startline   |   | Trendline                           |                                     | Highline                    |                             |                             |
|--------------------------------------|--|--|---|---|-------------------------------------|-------------------------------------|-----------------------------|-----------------------------|-----------------------------|
|                                      |  |  | Basic (ex VAT)  | Total RRP (inc VAT)                       | Basic (ex VAT)                      | Total RRP (inc VAT)                 | Basic (ex VAT)              | Total RRP (inc VAT)         |                             |
| <b>Satellite-navigation</b>          |  |  |   |   |                                     |                                     |                             |                             |                             |
| <b>RNS 315</b>                       |   | A great sat-nav to help you get where you're going. It includes a trip computer, a multi-function display and RDS (Radio Data System) for live traffic updates. Only in combination with RCD 310 | ✓ 5" colour touch-screen<br>✓ 6GB flash memory<br>✓ Four speakers<br>✓ FM/AM radio with RDS<br>✓ Single CD player<br>✓ Aux-in for external devices<br>✓ Western Europe map data       | Panel van<br>Maxi panel van<br>Maxi kombi | £505.00<br>£505.00<br>£505.00       | £606.00<br>£606.00<br>£606.00       | £255.00<br>£255.00<br>-     | £306.00<br>£306.00<br>-     | £255.00<br>£255.00<br>-     |
| <b>RNS 510</b>                       |  | This sat-nav system has a 6.5" colour touch-screen for easy use. Includes a trip computer and multi-function display. Not with DAB   | ✓ 6.5" colour touch-screen<br>✓ 30GB HDD and SD slot<br>✓ Four speakers<br>✓ FM/AM radio with RDS<br>✓ Single CD player<br>✓ Aux-in for external devices<br>✓ Western Europe map data | Panel van<br>Maxi panel van<br>Maxi kombi | £2,020.00<br>£2,020.00<br>£2,020.00 | £2,424.00<br>£2,424.00<br>£2,424.00 | £1,920.00<br>£1,920.00<br>- | £2,304.00<br>£2,304.00<br>- | £1,920.00<br>£1,920.00<br>- |
| <b>Phone and other audio options</b> |  |  |   |   |                                     |                                     |                             |                             |                             |
| <b>Bluetooth® connectivity</b>       |  | Go hands-free with compatible devices. This system includes a multi-function display 'plus'  | Bluetooth®+ (not on 4MOTION® models)<br>Bluetooth®+ (for RNS 315, Maxi kombi and 4MOTION® models)   |   | £275.00<br>£210.00                  | £330.00<br>£252.00                  | S<br>S                      | S<br>S                      | S<br>S                      |
| <b>CD changer</b>                    |  | Six-disc unit set in centre console, with armrest<br>This item replaces standard rubber floor with carpet  |   | Maxi kombi only                           | £320.00                             | £384.00                             | -                           | -                           | -                           |



## Options: Body, chassis and windows

Tailor your Caddy to the specific demands of your job with our body and chassis options, including rear and side doors, towbars and roof rails

|   |                | Startline      |                     | Trendline      |                     | Highline       |                     |
|---|----------------|----------------|---------------------|----------------|---------------------|----------------|---------------------|
|   |                | Basic (ex VAT) | Total RRP (inc VAT) | Basic (ex VAT) | Total RRP (inc VAT) | Basic (ex VAT) | Total RRP (inc VAT) |
| <b>Body-coloured bumpers</b>  |                |                |                     |                |                     |                |                     |
| <b>Body-coloured bumpers and wing mirrors</b><br>Requires electric windows and electrically heated and adjustable mirrors. Not all colours are available – please ask your Van Centre for details | Panel van      | £210.00        | £252.00             | S              | S                   | S              | S                   |
|   | Maxi panel van | £210.00        | £252.00             | S              | S                   | S              | S                   |
|   | Maxi kombi     | –              | –                   | –              | –                   | –              | –                   |
| <b>Body-coloured bumpers only</b><br>Not all colours are available – please ask your Van Centre for details   | Panel van      | –              | –                   | –              | –                   | –              | –                   |
|   | Maxi panel van | –              | –                   | –              | –                   | –              | –                   |
|   | Maxi kombi     | £165.00        | £198.00             | –              | –                   | –              | –                   |
| <b>Rear doors</b>   |                |                |                     |                |                     |                |                     |
| <b>Rear wing doors with heated window and wash/wipe</b><br>Only with bulkhead deleted in Maxi models  | Panel van      | S              | S                   | S              | S                   | S              | S                   |
|   | Maxi panel van | O              | O                   | –              | –                   | –              | –                   |
|   | Maxi kombi     | £105.00        | £126.00             | –              | –                   | –              | –                   |
| <b>Rear wing doors with opaque glass</b><br>Does not include heated rear windows and wash/wipe  | Panel van      | O              | O                   | O              | O                   | O              | O                   |
|   | Maxi panel van | S              | S                   | S              | S                   | S              | S                   |
|   | Maxi kombi     | –              | –                   | –              | –                   | –              | –                   |
| <b>Rear wing doors with clear glass</b><br>Does not include heated rear windows and wash/wipe. Requires bulkhead to be removed on Maxi panel van  | Panel van      | O              | O                   | O              | O                   | O              | O                   |
|   | Maxi panel van | O              | O                   | O              | O                   | O              | O                   |
|   | Maxi kombi     | –              | –                   | –              | –                   | –              | –                   |
| <b>Tailgate</b><br>Not with ladder flap. Requires bulkhead deleted. Bulkhead with upper mesh to be fitted on Maxi panel van. Not available on C20 models  | Panel van      | O              | O                   | O              | O                   | O              | O                   |
|   | Maxi panel van | O              | O                   | O              | O                   | O              | O                   |
|   | Maxi kombi     | S              | S                   | –              | –                   | –              | –                   |
| <b>Side doors</b>   |                |                |                     |                |                     |                |                     |
| <b>Sliding door – driver side</b><br>Gives you two sliding doors, as passenger-side door is standard  | Panel van      | £260.00        | £312.00             | £260.00        | £312.00             | £260.00        | £312.00             |
|   | Maxi panel van | S              | S                   | S              | S                   | S              | S                   |
|   | Maxi kombi     | S              | S                   | S              | S                   | S              | S                   |



### Choose your rear doors

The Caddy panel van has glazed asymmetric rear wing doors as standard, but you can pick various glazing options, including tinted glass or heated windows with wash-wipe. You could also choose a tailgate with a heated window, too.



### Fit an extra side door

The Caddy panel van comes with a sliding door on the nearside as standard. Fitting a side door on the offside lets you access your load from the pavement, no matter what side of the road you have to park on.

– not available S standard O no-cost option

|  |                | Startline      |                     | Trendline      |                     | Highline       |                     |
|--|----------------|----------------|---------------------|----------------|---------------------|----------------|---------------------|
|  |                | Basic (ex VAT) | Total RRP (inc VAT) | Basic (ex VAT) | Total RRP (inc VAT) | Basic (ex VAT) | Total RRP (inc VAT) |
| <b>Passenger windows</b>   |                |                |                     |                |                     |                |                     |
| <b>Privacy glass</b><br>For rear passenger doors of Maxi kombi   | Panel van      | –              | –                   | –              | –                   | –              | –                   |
|  | Maxi panel van | –              | –                   | –              | –                   | –              | –                   |
|  | Maxi kombi     | £135.00        | £162.00             | –              | –                   | –              | –                   |
| <b>Sliding windows</b><br>Replaces fixed windows in side doors of Maxi kombi   | Panel van      | –              | –                   | –              | –                   | –              | –                   |
|  | Maxi panel van | –              | –                   | –              | –                   | –              | –                   |
|  | Maxi kombi     | £335.00        | £402.00             | –              | –                   | –              | –                   |
| <b>Towbars</b>   |                |                |                     |                |                     |                |                     |
| <b>Fixed ball with 13-pin socket</b><br>Includes Trailer Stability Assist, operated via the vehicle's Electronic Stabilisation Programme (ESP)                                 | Panel van      | £340.00        | £408.00             | £340.00        | £408.00             | £340.00        | £408.00             |
|  | Maxi panel van | £340.00        | £408.00             | £340.00        | £408.00             | £340.00        | £408.00             |
|  | Maxi kombi     | £340.00        | £408.00             | –              | –                   | –              | –                   |
| <b>Removable ball with 13-pin socket</b><br>Includes Trailer Stability Assist, operated via the vehicle's Electronic Stabilisation Programme (ESP)                             | Panel van      | –              | –                   | –              | –                   | –              | –                   |
|  | Maxi panel van | –              | –                   | –              | –                   | –              | –                   |
|  | Maxi kombi     | £480.00        | £576.00             | –              | –                   | –              | –                   |
| <b>Other body and chassis options</b>  |                |                |                     |                |                     |                |                     |
| <b>Roof rails (black)</b><br>Various roof-rack storage solutions are available in our Add Ons accessories range. Ask your Van Centre for details                               | Panel van      | £155.00        | £186.00             | £155.00        | £186.00             | £155.00        | £186.00             |
|  | Maxi panel van | £155.00        | £186.00             | £155.00        | £186.00             | £155.00        | £186.00             |
|  | Maxi kombi     | £155.00        | £186.00             | –              | –                   | –              | –                   |
| <b>Reinforced suspension</b>   | Panel van      | £120.00        | £144.00             | £120.00        | £144.00             | £120.00        | £144.00             |
|  | Maxi panel van | £260.00        | £312.00             | £260.00        | £312.00             | £260.00        | £312.00             |
|  | Maxi kombi     | £260.00        | £312.00             | –              | –                   | –              | –                   |
| <b>Underbody protection</b><br>Measurements against stone chips under vehicle body – axle tube, rear axle, shielding of coupling bar, guide tube, cover fuel measurement strip | Panel van      | £20.00         | £24.00              | £20.00         | £24.00              | £20.00         | £24.00              |
|  | Maxi panel van | £20.00         | £24.00              | £20.00         | £24.00              | £20.00         | £24.00              |
|  | Maxi kombi     | £20.00         | £24.00              | –              | –                   | –              | –                   |
| <b>Additional front underbody guard</b>  | Panel van      | £215.00        | £258.00             | £215.00        | £258.00             | £215.00        | £258.00             |
|  | Maxi panel van | £215.00        | £258.00             | £215.00        | £258.00             | £215.00        | £258.00             |
|  | Maxi kombi     | –              | –                   | –              | –                   | –              | –                   |

**Add Ons**  
Accessories to help keep your vehicle 100% Volkswagen

If you want even more choice for body and chassis upgrades, check out our Add Ons accessories range, which includes lots of towing and roof-rack solutions. Ask your Van Centre for a brochure, call 0800 717 131 or download a copy at [www.volkswagen-vans.co.uk](http://www.volkswagen-vans.co.uk)

## Options: Cargo area

A range of floor coverings and bulkheads to make light work of your most challenging cargo requirements

|  |   | Startline               |                         | Trendline               |                         | Highline                |                         |
|--|---|-------------------------|-------------------------|-------------------------|-------------------------|-------------------------|-------------------------|
|  |   | Basic (ex VAT)          | Total RRP (inc VAT)     | Basic (ex VAT)          | Total RRP (inc VAT)     | Basic (ex VAT)          | Total RRP (inc VAT)     |
| <b>Bulkheads</b>   |   |                         |                         |                         |                         |                         |                         |
| <b>Bulkhead deleted</b><br>Not available on C20+ models. On Maxi panel van models, this option is only available with heated rear window and wash/wipe | Panel van<br>Maxi panel van<br>Maxi kombi | ○<br>○<br>-             | ○<br>○<br>-             | ○<br>○<br>-             | ○<br>○<br>-             | ○<br>○<br>-             | ○<br>○<br>-             |
| <b>Bulkhead with upper mesh</b><br>Not compatible with Siracusa or Zolder alloy wheels   | Panel van<br>Maxi panel van<br>Maxi kombi | -<br>○<br>-             | -<br>○<br>-             | -<br>○<br>-             | -<br>○<br>-             | -<br>○<br>-             | -<br>○<br>-             |
| <b>Ladder flap</b>   |   |                         |                         |                         |                         |                         |                         |
| <b>Ladder flap in roof</b><br>Only available with driver and passenger side door.<br>Not compatible with tailgate                                      | Panel van<br>Maxi panel van<br>Maxi kombi | £210.00<br>£210.00<br>- | £252.00<br>£252.00<br>- | £210.00<br>£210.00<br>- | £252.00<br>£252.00<br>- | £210.00<br>£210.00<br>- | £252.00<br>£252.00<br>- |



### Choose a bulkhead

Bulkheads separate the load space from the cab, giving you greater protection from shifting loads, less noise from the cargo bay and a warmer cab in winter.

- not available S standard ○ no-cost option

|   |   | Startline             |                         | Trendline             |                         | Highline              |                         |
|---|---|-----------------------|-------------------------|-----------------------|-------------------------|-----------------------|-------------------------|
|   |   | Basic (ex VAT)        | Total RRP (inc VAT)     | Basic (ex VAT)        | Total RRP (inc VAT)     | Basic (ex VAT)        | Total RRP (inc VAT)     |
| <b>Load-floor covers</b>  |   |                       |                         |                       |                         |                       |                         |
| <b>Rubber load-floor cover</b>  | Panel van<br>Maxi panel van<br>Maxi kombi | £90.00<br>£90.00<br>S | £108.00<br>£108.00<br>S | £90.00<br>£90.00<br>- | £108.00<br>£108.00<br>- | £90.00<br>£90.00<br>- | £108.00<br>£108.00<br>- |
| <b>Carpet flooring in cab and passenger bay</b><br>In lieu of rubber load-floor cover on Maxi kombi | Panel van<br>Maxi panel van<br>Maxi kombi | -<br>-<br>○           | -<br>-<br>○             | -<br>-<br>-           | -<br>-<br>-             | -<br>-<br>-           | -<br>-<br>-             |
| <b>Storage</b>  |   |                       |                         |                       |                         |                       |                         |
| <b>Partition net for luggage compartment</b>  | Panel van<br>Maxi panel van<br>Maxi kombi | -<br>-<br>£110.00     | -<br>-<br>£132.00       | -<br>-<br>-           | -<br>-<br>-             | -<br>-<br>-           | -<br>-<br>-             |



### Get the right cover

A carpet load-floor covering helps protect the interior of your van from damage. A rubber load-floor covering helps items to bed in, preventing them from shifting.

## Add Ons

Accessories to help keep your vehicle 100% Volkswagen

If you want even more choice for cargo bay storage and protection check out our Add Ons accessories range, which includes plying, boot-liners and load bags. Ask your Van Centre for a brochure, call 0800 717131 or download a copy at [www.volkswagen-vans.co.uk](http://www.volkswagen-vans.co.uk)



## Options: Comfort and convenience

From cruise control to a multi-function steering wheel, we've got a range of features to make driving even easier and even more comfortable

|  |                | Startline      |                     | Trendline      |                     | Highline       |                     |
|--|----------------|----------------|---------------------|----------------|---------------------|----------------|---------------------|
|  |                | Basic (ex VAT) | Total RRP (inc VAT) | Basic (ex VAT) | Total RRP (inc VAT) | Basic (ex VAT) | Total RRP (inc VAT) |
| <b>Driving aids</b>  |                |                |                     |                |                     |                |                     |
| <b>Electric windows and electrically heated and adjustable mirrors</b>   | Panel van      | £295.00        | £354.00             | S              | S                   | S              | S                   |
|  | Maxi panel van | £295.00        | £354.00             | S              | S                   | S              | S                   |
|  | Maxi kombi     | £295.00        | £354.00             | -              | -                   | -              | -                   |
| <b>Cruise control</b><br><small>Standard on all BlueMotion Technology models</small>   | Panel van      | £190.00        | £228.00             | S              | S                   | S              | S                   |
|  | Maxi panel van | £190.00        | £228.00             | S              | S                   | S              | S                   |
|  | Maxi kombi     | £190.00        | £228.00             | -              | -                   | -              | -                   |
| <b>Cruise control with multi-function display</b><br><small>Not compatible with 4MOTION® models</small>  | Panel van      | £295.00        | £354.00             | £295.00        | £354.00             | £295.00        | £354.00             |
|  | Maxi panel van | £295.00        | £354.00             | £295.00        | £354.00             | £295.00        | £354.00             |
|  | Maxi kombi     | -              | -                   | -              | -                   | -              | -                   |
| <b>Cruise control with multi-function display</b><br><small>Only compatible with 4MOTION® models</small>   | Panel van      | £180.00        | £216.00             | £180.00        | £216.00             | £180.00        | £216.00             |
|  | Maxi panel van | £180.00        | £216.00             | £180.00        | £216.00             | £180.00        | £216.00             |
|  | Maxi kombi     | -              | -                   | -              | -                   | -              | -                   |
| <b>Power steering with mobility aid</b>  | Panel van      | £60.00         | £72.00              | £60.00         | £72.00              | £60.00         | £72.00              |
|  | Maxi panel van | £60.00         | £72.00              | £60.00         | £72.00              | £60.00         | £72.00              |
|  | Maxi kombi     | -              | -                   | -              | -                   | -              | -                   |
| <b>Headlights and washers</b>  |                |                |                     |                |                     |                |                     |
| <b>Bi-xenon headlights</b><br><small>Dynamic bend lighting, LED daytime running lights and cornering lights. Requires front fog lights when ordered with body-coloured bumpers and door mirrors</small>                          | Panel van      | £960.00        | £1,152.00           | £960.00        | £1,152.00           | £960.00        | £1,152.00           |
|  | Maxi panel van | £960.00        | £1,152.00           | £960.00        | £1,152.00           | £960.00        | £1,152.00           |
|  | Maxi kombi     | £960.00        | £1,152.00           | -              | -                   | -              | -                   |
| <b>Visibility pack</b><br><small>Comprises rain sensors, automatic dimming rear-view mirror and 'coming home' function</small>   | Panel van      | £135.00        | £162.00             | £135.00        | £162.00             | £135.00        | £162.00             |
|  | Maxi panel van | £135.00        | £162.00             | £135.00        | £162.00             | £135.00        | £162.00             |
|  | Maxi kombi     | £135.00        | £162.00             | -              | -                   | -              | -                   |
| <b>Winter pack</b><br><small>Comprises headlight washers, heated washer jets, washer fluid-level indicator, heated driver and front passenger seats, and auxiliary electric heater. Only available with front fog lights</small> | Panel van      | £455.00        | £546.00             | £455.00        | £546.00             | £455.00        | £546.00             |
|  | Maxi panel van | £455.00        | £546.00             | £455.00        | £546.00             | £455.00        | £546.00             |
|  | Maxi kombi     | £455.00        | £546.00             | -              | -                   | -              | -                   |



### Go for cruise control

Cruise control can help reduce the fatigue and stress of sticking to speed limits on long journeys. It also helps reduce the amount of fuel you use by cutting out the acceleration and braking used to maintain a steady road speed.

|   |                | Startline      |                     | Trendline      |                     | Highline       |                     |
|---|----------------|----------------|---------------------|----------------|---------------------|----------------|---------------------|
|   |                | Basic (ex VAT) | Total RRP (inc VAT) | Basic (ex VAT) | Total RRP (inc VAT) | Basic (ex VAT) | Total RRP (inc VAT) |
| <b>Interior</b>   |                |                |                     |                |                     |                |                     |
| <b>Leather-covered steering wheel</b>   | Panel van      | £105.00        | £126.00             | S              | S                   | S              | S                   |
|   | Maxi panel van | £100.00        | £120.00             | S              | S                   | S              | S                   |
|   | Maxi kombi     | -              | -                   | -              | -                   | -              | -                   |
| <b>Leather-covered multi-function steering wheel</b><br><small>Includes trip computer and multi-function display. Not compatible with 4MOTION® models. Requires upgraded radio on Maxi kombi. Deletes leather gearknob and gaiter on Highline</small> | Panel van      | £300.00        | £360.00             | £300.00        | £360.00             | £300.00        | £360.00             |
|   | Maxi panel van | £300.00        | £360.00             | £300.00        | £360.00             | £300.00        | £360.00             |
|   | Maxi kombi     | £300.00        | £360.00             | -              | -                   | -              | -                   |
| <b>Leather-covered multi-function steering wheel</b><br><small>Includes trip computer and multi-function display. Only compatible with 4MOTION® models. Deletes leather gearknob and gaiter on Highline</small>                                       | Panel van      | £180.00        | £216.00             | £180.00        | £216.00             | £180.00        | £216.00             |
|   | Maxi panel van | £180.00        | £216.00             | £180.00        | £216.00             | £180.00        | £216.00             |
|   | Maxi kombi     | -              | -                   | -              | -                   | -              | -                   |
| <b>Dashboard with tray cover</b>  | Panel van      | £45.00         | £54.00              | S              | S                   | S              | S                   |
|   | Maxi panel van | £45.00         | £54.00              | S              | S                   | S              | S                   |
|   | Maxi kombi     | -              | -                   | -              | -                   | -              | -                   |
| <b>Storage compartment under front seats</b>  | Panel van      | £20.00         | £24.00              | S              | S                   | S              | S                   |
|   | Maxi panel van | £20.00         | £24.00              | S              | S                   | S              | S                   |
|   | Maxi kombi     | -              | -                   | -              | -                   | -              | -                   |
| <b>Carpet flooring in cab</b>   | Panel van      | £85.00         | £102.00             | £85.00         | £102.00             | £85.00         | £102.00             |
|   | Maxi panel van | £85.00         | £102.00             | £85.00         | £102.00             | £85.00         | £102.00             |
|   | Maxi kombi     | -              | -                   | -              | -                   | -              | -                   |
| <b>Sunvisor with vanity mirror (and cover)</b><br><small>For driver and passenger</small>   | Panel van      | £20.00         | £24.00              | S              | S                   | S              | S                   |
|   | Maxi panel van | £20.00         | £24.00              | S              | S                   | S              | S                   |
|   | Maxi kombi     | -              | -                   | -              | -                   | -              | -                   |
| <b>Smoking pack</b><br><small>Ashtray and cigarette lighter in lieu of 12V socket</small>   | Panel van      | £15.00         | £18.00              | £15.00         | £18.00              | £15.00         | £18.00              |
|   | Maxi panel van | £15.00         | £18.00              | £15.00         | £18.00              | £15.00         | £18.00              |
|   | Maxi kombi     | £15.00         | £18.00              | -              | -                   | -              | -                   |

**Add Ons**  
Accessories to help keep your vehicle 100% Volkswagen

If you want even more choice for cab comfort and convenience, check out our Add Ons accessories range. Ask your Van Centre for a brochure, call 0800 717 131 or download yourself a copy at [www.volkswagen-vans.co.uk](http://www.volkswagen-vans.co.uk)

## Options: Heating and ventilation

Keep control of the temperature in your van with our heating and air-conditioning options

|  |                | Startline      |                     | Trendline      |                     | Highline       |                     |
|--|----------------|----------------|---------------------|----------------|---------------------|----------------|---------------------|
|  |                | Basic (ex VAT) | Total RRP (inc VAT) | Basic (ex VAT) | Total RRP (inc VAT) | Basic (ex VAT) | Total RRP (inc VAT) |
| <b>Heating and ventilation</b>   |                |                |                     |                |                     |                |                     |
| <b>Climatic manual air-conditioning</b><br>Not compatible with uprated battery/alternator combination  | Panel van      | £810.00        | £972.00             | £810.00        | £972.00             | S              | S                   |
|  | Maxi panel van | £810.00        | £972.00             | £810.00        | £972.00             | S              | S                   |
|  | Maxi kombi     | £810.00        | £972.00             | -              | -                   | -              | -                   |
| <b>Climatronic semi-automatic air-conditioning</b><br>Not compatible with rear wing doors with opaque glass.<br>Requires tailgate to be fitted on Maxi panel van | Panel van      | £1,035.00      | £1,242.00           | £1,035.00      | £1,242.00           | £230.00        | £276.00             |
|  | Maxi panel van | £1,035.00      | £1,242.00           | £1,035.00      | £1,242.00           | £230.00        | £276.00             |
|  | Maxi kombi     | -              | -                   | -              | -                   | -              | -                   |
| <b>Air-conditioning with laminated windscreen</b>  | Panel van      | £885.00        | £1,062.00           | £885.00        | £1,062.00           | £100.00        | £120.00             |
|  | Maxi panel van | £885.00        | £1,062.00           | £885.00        | £1,062.00           | £100.00        | £120.00             |
|  | Maxi kombi     | £885.00        | £1,062.00           | -              | -                   | -              | -                   |
| <b>Auxiliary vehicle heater</b>  | Panel van      | £375.00        | £450.00             | £375.00        | £450.00             | £375.00        | £450.00             |
|  | Maxi panel van | £375.00        | £450.00             | £375.00        | £450.00             | £375.00        | £450.00             |
|  | Maxi kombi     | £375.00        | £450.00             | -              | -                   | -              | -                   |
| <b>Fresh-air intake with charcoal canister</b>   | Panel van      | £15.00         | £18.00              | £15.00         | £18.00              | £15.00         | £18.00              |
|  | Maxi panel van | £15.00         | £18.00              | £15.00         | £18.00              | £15.00         | £18.00              |
|  | Maxi kombi     | -              | -                   | -              | -                   | -              | -                   |



### Get yourself an air-con recharge







You may be able to get your air-conditioning system recharged and pollen filter replaced at your nearest Van Centre to keep them working as they should. Ask your Van Centre for details.

## Options: Seating, trim and upholstery

Improve the comfort and practicality of your Caddy with heated seats and a selection of upholstery finishes

|   |                | Startline      |                     | Trendline      |                     | Highline       |                     |
|---|----------------|----------------|---------------------|----------------|---------------------|----------------|---------------------|
|   |                | Basic (ex VAT) | Total RRP (inc VAT) | Basic (ex VAT) | Total RRP (inc VAT) | Basic (ex VAT) | Total RRP (inc VAT) |
| <b>Seat options</b>   |                |                |                     |                |                     |                |                     |
| <b>Height adjustment for front seats</b><br>Height adjustment on driver seat is standard. Includes under-seat storage on Maxi kombi | Panel van      | £150.00        | £180.00             | S              | S                   | S              | S                   |
|   | Maxi panel van | £150.00        | £180.00             | S              | S                   | S              | S                   |
|   | Maxi kombi     | £225.00        | £270.00             | -              | -                   | -              | -                   |
| <b>Heated driver and front passenger seats</b>  | Panel van      | £210.00        | £252.00             | £210.00        | £252.00             | £210.00        | £252.00             |
|   | Maxi panel van | £210.00        | £252.00             | £210.00        | £252.00             | £210.00        | £252.00             |
|   | Maxi kombi     | £210.00        | £252.00             | -              | -                   | -              | -                   |
| <b>Lumbar support for both front seats</b>  | Panel van      | £115.00        | £138.00             | £115.00        | £138.00             | £115.00        | £138.00             |
|   | Maxi panel van | £115.00        | £138.00             | £115.00        | £138.00             | £115.00        | £138.00             |
|   | Maxi kombi     | £115.00        | £138.00             | -              | -                   | -              | -                   |
| <b>Lumbar support for driver seat</b>   | Panel van      | £60.00         | £72.00              | £60.00         | £72.00              | £60.00         | £72.00              |
|   | Maxi panel van | £60.00         | £72.00              | £60.00         | £72.00              | £60.00         | £72.00              |
|   | Maxi kombi     | £60.00         | £72.00              | -              | -                   | -              | -                   |
| <b>Lumbar support for passenger seat</b>  | Panel van      | £60.00         | £72.00              | £60.00         | £72.00              | £60.00         | £72.00              |
|   | Maxi panel van | £60.00         | £72.00              | £60.00         | £72.00              | £60.00         | £72.00              |
|   | Maxi kombi     | £60.00         | £72.00              | -              | -                   | -              | -                   |

### Upholstery and trims

|                                |   |                |        |        |        |        |        |        |
|--------------------------------|---|----------------|--------|--------|--------|--------|--------|--------|
| <b>Austin cloth upholstery</b> |   | Panel van      | S      | S      | S      | S      | S      | S      |
|                                |  | Maxi panel van | S      | S      | S      | S      | S      | S      |
|                                |   | Maxi kombi     | -      | -      | -      | -      | -      | -      |
| <b>Timo cloth upholstery</b>   |   | Panel van      | -      | -      | -      | -      | -      | -      |
|                                |  | Maxi panel van | -      | -      | -      | -      | -      | -      |
|                                |   | Maxi kombi     | S      | S      | -      | -      | -      | -      |
| <b>Leatherette upholstery</b>  |   | Panel van      | £20.00 | £24.00 | £20.00 | £24.00 | £20.00 | £24.00 |
|                                |  | Maxi panel van | £20.00 | £24.00 | £20.00 | £24.00 | £20.00 | £24.00 |
|                                |  | Maxi kombi     | £20.00 | £24.00 | -      | -      | -      | -      |
| <b>Robust upholstery</b>       |   | Panel van      | £35.00 | £42.00 | £35.00 | £42.00 | £35.00 | £42.00 |
|                                |  | Maxi panel van | £35.00 | £42.00 | £35.00 | £42.00 | £35.00 | £42.00 |
|                                |  | Maxi kombi     | -      | -      | -      | -      | -      | -      |



### Pick the right upholstery

Fabric upholstery is terrifically hard-wearing, while leatherette upholstery is great for cleaning quickly and easily.



If you want even more seating and trim options – including leather seats – check out our Add Ons accessories range. Ask your Van Centre for a brochure, call 0800 717 131 or download a copy for yourself at [www.volkswagen-vans.co.uk](http://www.volkswagen-vans.co.uk).



## Options: Safety and security

Parking sensors, airbag packs and sophisticated alarms that enhance the safety of you, your Caddy and its contents

|   |                | Startline      |                     | Trendline      |                     | Highline       |                     |
|---|----------------|----------------|---------------------|----------------|---------------------|----------------|---------------------|
|   |                | Basic (ex VAT) | Total RRP (inc VAT) | Basic (ex VAT) | Total RRP (inc VAT) | Basic (ex VAT) | Total RRP (inc VAT) |
| <b>Airbags</b>  |                |                |                     |                |                     |                |                     |
| <b>Front passenger airbag with deactivation switch</b>  | Panel van      | £195.00        | £234.00             | £195.00        | £234.00             | £195.00        | £234.00             |
|   | Maxi panel van | £195.00        | £234.00             | £195.00        | £234.00             | £195.00        | £234.00             |
|   | Maxi kombi     | S              | S                   | –              | –                   | –              | –                   |
| <b>Front passenger airbag with deactivation switch; driver and passenger side and curtain airbags</b>   | Panel van      | £515.00        | £618.00             | £515.00        | £618.00             | £515.00        | £618.00             |
|   | Maxi panel van | £515.00        | £618.00             | £515.00        | £618.00             | £515.00        | £618.00             |
|   | Maxi kombi     | £315.00        | £378.00             | –              | –                   | –              | –                   |
| <b>Alarms</b>   |                |                |                     |                |                     |                |                     |
| <b>Alarm with back-up horn</b>  | Panel van      | £145.00        | £174.00             | £145.00        | £174.00             | –              | –                   |
|   | Maxi panel van | £145.00        | £174.00             | £145.00        | £174.00             | –              | –                   |
|   | Maxi kombi     | £145.00        | £174.00             | –              | –                   | –              | –                   |
| <b>Alarm with passenger compartment control, back-up horn and towing protection</b>   | Panel van      | £165.00        | £198.00             | £165.00        | £198.00             | –              | –                   |
|   | Maxi panel van | £165.00        | £198.00             | £165.00        | £198.00             | –              | –                   |
|   | Maxi kombi     | £165.00        | £198.00             | –              | –                   | –              | –                   |
| <b>Perimeter alarm with back-up horn</b><br><small>Includes central locking and separate unlocking for driver door</small>                                  | Panel van      | £150.00        | £180.00             | £150.00        | £180.00             | –              | –                   |
|   | Maxi panel van | £150.00        | £180.00             | £150.00        | £180.00             | –              | –                   |
|   | Maxi kombi     | £150.00        | £180.00             | –              | –                   | –              | –                   |
| <b>Thatcham Category 1 interior alarm (cab only) with tow-away protection</b>   | Panel van      | £180.00        | £216.00             | £180.00        | £216.00             | S              | S                   |
|   | Maxi panel van | £180.00        | £216.00             | £180.00        | £216.00             | S              | S                   |
|   | Maxi kombi     | £180.00        | £216.00             | –              | –                   | –              | –                   |
| <b>Driver seatbelt alarm</b><br><small>Buzzer alarm and light for unfastened driver seatbelt<br/>Fitted as standard on BlueMotion Technology models</small> | Panel van      | £15.00         | £18.00              | £15.00         | £18.00              | £15.00         | £18.00              |
|   | Maxi panel van | £15.00         | £18.00              | £15.00         | £18.00              | £15.00         | £18.00              |
|   | Maxi kombi     | –              | –                   | –              | –                   | –              | –                   |



### Useful security tips

#### 1. Get an alarm

Alarm noise may be enough to scare a thief and prevent a costly break-in.

#### 2. Lock your doors

Even if you're only away from your van for a minute, locked doors deter thieves looking for an easy target.

#### 3. Keep it tidy

Seemingly trivial items can still be bait to thieves. Stow gadgets out of sight or take them with you. Thieves know to look in the glove box, too.

#### 4. Load out of sight

Try and load your van in a secure location. Thieves can linger in public areas for an easy swipe-and-run.

#### 5. Park for visibility

Use well-lit areas. Avoid parking near vehicles or foliage that a thief could use for cover. Parking right up against walls can stop a thief getting in through your van's doors, too.

– not available S standard O no-cost option

|   |                | Startline      |                     | Trendline      |                     | Highline       |                     |
|---|----------------|----------------|---------------------|----------------|---------------------|----------------|---------------------|
|   |                | Basic (ex VAT) | Total RRP (inc VAT) | Basic (ex VAT) | Total RRP (inc VAT) | Basic (ex VAT) | Total RRP (inc VAT) |
| <b>Fog lights</b>   |                |                |                     |                |                     |                |                     |
| <b>Fog lights</b>   | Panel van      | £120.00        | £144.00             | £120.00        | £144.00             | S              | S                   |
|   | Maxi panel van | £120.00        | £144.00             | £120.00        | £144.00             | S              | S                   |
|   | Maxi kombi     | £120.00        | £144.00             | –              | –                   | –              | –                   |
| <b>Fog lights with cornering function</b>   | Panel van      | £195.00        | £234.00             | £195.00        | £234.00             | £80.00         | £96.00              |
|   | Maxi panel van | £195.00        | £234.00             | £195.00        | £234.00             | £80.00         | £96.00              |
|   | Maxi kombi     | £195.00        | £234.00             | –              | –                   | –              | –                   |
| <b>Hill Hold Assist</b>   |                |                |                     |                |                     |                |                     |
| <b>Hill Hold Assist</b><br><small>Standard on 4MOTION® and BlueMotion Technology models</small>   | Panel van      | £85.00         | £102.00             | £85.00         | £102.00             | £85.00         | £102.00             |
|   | Maxi panel van | £85.00         | £102.00             | £85.00         | £102.00             | £85.00         | £102.00             |
|   | Maxi kombi     | £85.00         | £102.00             | –              | –                   | –              | –                   |
| <b>Parking sensors</b>  |                |                |                     |                |                     |                |                     |
| <b>Parking sensors – rear</b>   | Panel van      | £240.00        | £288.00             | S              | S                   | S              | S                   |
|   | Maxi panel van | £240.00        | £288.00             | S              | S                   | S              | S                   |
|   | Maxi kombi     | £240.00        | £288.00             | –              | –                   | –              | –                   |
| <b>Parallel Park Assist with distance control</b><br><small>Requires other options to be fitted.<br/>Please ask your Van Centre for full details.</small> | Panel van      | £500.00        | £600.00             | £500.00        | £600.00             | £500.00        | £600.00             |
|   | Maxi panel van | £500.00        | £600.00             | £500.00        | £600.00             | £500.00        | £600.00             |
|   | Maxi kombi     | £500.00        | £600.00             | –              | –                   | –              | –                   |
| <b>Emergency kits</b>   |                |                |                     |                |                     |                |                     |
| <b>First aid kit and warning triangle</b>   | Panel van      | £20.00         | £24.00              | £20.00         | £24.00              | £20.00         | £24.00              |
|   | Maxi panel van | £20.00         | £24.00              | £20.00         | £24.00              | £20.00         | £24.00              |
|   | Maxi kombi     | £20.00         | £24.00              | –              | –                   | –              | –                   |
| <b>Fire extinguisher</b>  | Panel van      | £40.00         | £48.00              | £40.00         | £48.00              | £40.00         | £48.00              |
|   | Maxi panel van | £40.00         | £48.00              | £40.00         | £48.00              | £40.00         | £48.00              |
|   | Maxi kombi     | –              | –                   | –              | –                   | –              | –                   |

## Options: Electrical

Choose these electrical features to give your Caddy a functional and practical edge

|  |                | Startline      |                     | Trendline      |                     | Highline       |                     |
|--|----------------|----------------|---------------------|----------------|---------------------|----------------|---------------------|
|  |                | Basic (ex VAT) | Total RRP (inc VAT) | Basic (ex VAT) | Total RRP (inc VAT) | Basic (ex VAT) | Total RRP (inc VAT) |
| <b>Up-rated battery/alternator</b><br>380A/72Ah battery and 140A alternator. Not compatible with Climatic air-conditioning or BlueMotion Technology models | Panel van      | £105.00        | £126.00             | £105.00        | £126.00             | £105.00        | £126.00             |
|  | Maxi panel van | £105.00        | £126.00             | £105.00        | £126.00             | £105.00        | £126.00             |
|  | Maxi kombi     | £105.00        | £126.00             | –              | –                   | –              | –                   |
| <b>Trip computer with multi-function display plus</b>  | Panel van      | £205.00        | £246.00             | S              | S                   | S              | S                   |
|  | Maxi panel van | £205.00        | £246.00             | S              | S                   | S              | S                   |
|  | Maxi kombi     | £205.00        | £246.00             | –              | –                   | –              | –                   |
| <b>Multi-function display</b>  | Panel van      | £120.00        | £144.00             | £120.00        | £144.00             | £120.00        | £144.00             |
|  | Maxi panel van | £120.00        | £144.00             | £120.00        | £144.00             | £120.00        | £144.00             |
|  | Maxi kombi     | –              | –                   | –              | –                   | –              | –                   |
| <b>12V socket in luggage compartment</b>   | Panel van      | £20.00         | £24.00              | £20.00         | £24.00              | £20.00         | £24.00              |
|  | Maxi panel van | £20.00         | £24.00              | £20.00         | £24.00              | £20.00         | £24.00              |
|  | Maxi kombi     | £20.00         | £24.00              | –              | –                   | –              | –                   |

# Want more? Pick an Add On...

The Caddy comes with a wide range of factory-fit options, but you may want something extra. That's where Add Ons comes in

**A**dd Ons is the new name for our extensive range of Volkswagen-approved accessories, available to buy and be fitted at your Van Centre. Whether you want to add extra style to your van, get more out of your cargo bay, convert a work van into a weekend leisure vehicle or add extra audio, phone and sat-nav to your cab, we've got lots of Add Ons for you.

### Help keep it 100% Volkswagen

There are big advantages to purchasing your accessories from Volkswagen. Add Ons have all been designed with Volkswagen in mind, so they're a perfect match for fit and style, and they've been designed and developed to be just as rugged, reliable and long-lasting as your vehicle.

### Keep your Add Ons covered

Most Add Ons come with a two-year warranty. However, if you order and fit them when you buy a new van, we may be able to extend that to three years to match your vehicle's warranty. Pop into your Van Centre and ask our staff about how much Add Ons can add to your life.



To get a brochure, pop into a Van Centre. To find your nearest one, call 0800 717131 or visit [www.volkswagen-vans.co.uk](http://www.volkswagen-vans.co.uk)

## Top five Caddy Add Ons



**16" Sima alloy wheel**  
Add extra style with these 6J x 16 alloys, which are exclusive to the Add Ons range.



**Pure in-vehicle digital radio**  
Enjoy more channels and improved reception quality with this professionally installed digital radio upgrade.



**Roof-bar set**  
Our roof bars can hold up to 100kg. You can order a range of roof-bar accessories to suit your load, too.



**Front and rear rubber mats**  
Protect your van's floor with these durable rubber mats. Their easy-to-use fixings ensure that they always remain securely fastened.



**Polished stainless steel side rails**  
These rails not only look good, they also protect your van's sills from damage. They're available for the Caddy and the Caddy Maxi.



# Data

All the facts and figures you'll need for your vehicle

## Caddy (all models): Engines

|                                      | 1.6TDI 75PS  | 1.6TDI 102PS      | 2.0TDI 110PS      | 2.0TDI 140PS      |
|--------------------------------------|--|-------------------|-------------------|-------------------|
| <b>Engine specifications</b>         |  |                   |                   |                   |
| Engine type                          | Diesel, transverse, water-cooled, in-line, variable turbine geometry turbocharger with intercooler |                   |                   |                   |
| Mixture preparation/injection method | Common-rail direct injection / turbocharger  |                   |                   |                   |
| EU exhaust emission standard         | EURO 5   |                   |                   |                   |
| No. of cylinders                     | 4  |                   |                   |                   |
| Cubic capacity                       | 1,598cc  | 1,598cc           | 1,968cc           | 1,968cc           |
| Output, PS at rpm                    | 75 at 3,000 - 4,000  | 102 at 4,400      | 110 at 4,200      | 140 at 4,200      |
| Torque, max. Nm/rpm                  | 225/1,500 - 2,250  | 250/1,500 - 2,500 | 280/1,500 - 2,500 | 320/1,750 - 2,750 |
| Diesel Particulate Filter (DPF)      | ●  | ●                 | ●                 | ●                 |
| 5-speed manual gearbox               | ●  | ●                 | -                 | -                 |
| 6-speed manual gearbox               | -  | -                 | ●                 | ●                 |
| 6-speed dual-clutch gearbox DSG      | -  | -                 | -                 | ●                 |
| 7-speed dual-clutch gearbox DSG      | -  | ●                 | -                 | -                 |
| Front-wheel drive                    | ●  | ●                 | -                 | ●                 |
| 4MOTION® four-wheel drive            | -  | -                 | ●                 | -                 |
| BlueMotion Technology                | ●  | ●                 | -                 | ●                 |

### Electrics

|                           |             |
|---------------------------|-------------|
| Alternator (all variants) | 110A        |
| Battery                   | 61Ah (330A) |

- Available
- Not available

Output (PS)  
Torque (Nm)

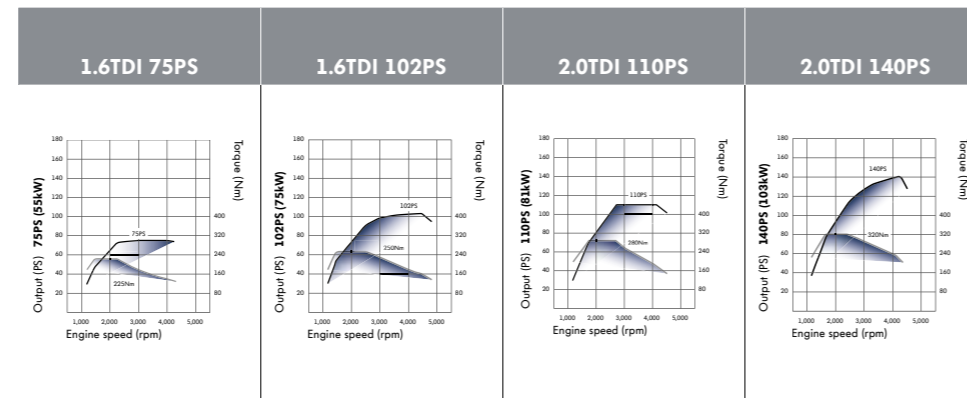

## Caddy panel van: Dimensions and weights

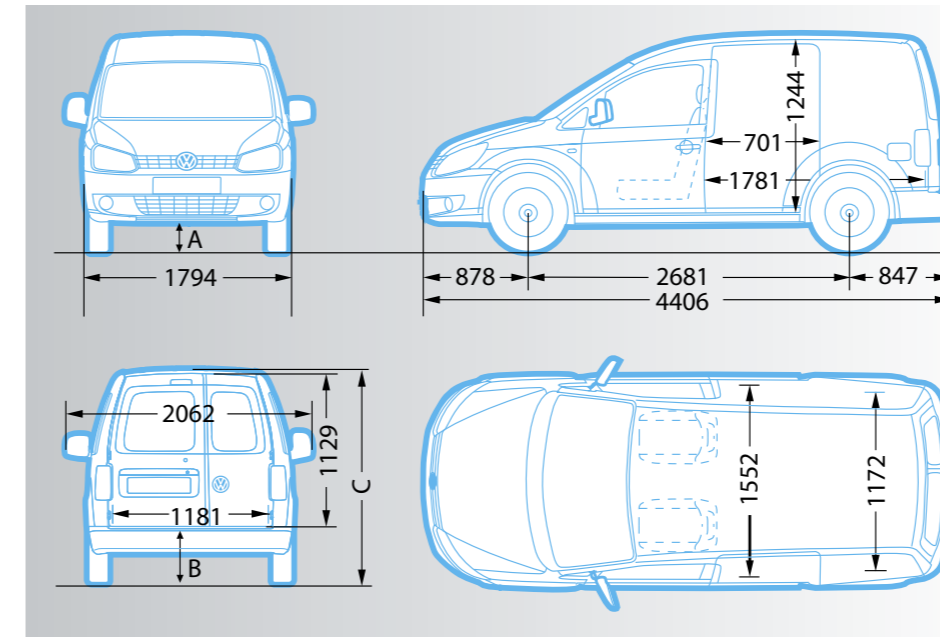

| Heights and clearances             | Front ground clearance (A) | Rear load height (B) | Overall vehicle height (C) |
|------------------------------------|----------------------------|----------------------|----------------------------|
| Standard and BlueMotion Technology | 159                        | 576                  | 1,823                      |
| 4MOTION®                           | 159                        | 642                  | 1,873                      |

Dimensions A, B and C refer to diagram, left

| Dimensions                    |                   |
|-------------------------------|-------------------|
| Wheelbase                     | 2,681             |
| <b>Load compartment</b>       |                   |
| Length                        | 1,781             |
| Volume                        | 3.2m <sup>3</sup> |
| <b>Side sliding door</b>      |                   |
| Width                         | 701               |
| Height                        | 1,100             |
| <b>Rear doors</b>             |                   |
| Width                         | 1,181             |
| Height                        | 1,129             |
| Turning circle (wall to wall) | 11.1m             |

Dimensions in millimetres (mm) unless otherwise indicated.

| Model / gross vehicle weight (kg) | Engine/transmission                          | Axle load limit front/rear (kg) | Trailer weight braked 12%/unbraked (kg) | Gross train weight (kg) | Startline             |                | Trendline             |                | Highline              |                |
|-----------------------------------|--|---------------------------------|---|-------------------------|-----------------------|----------------|-----------------------|----------------|-----------------------|----------------|
|                                   |  |                                 |   |                         | Unladen weight † (kg) | Payload † (kg) | Unladen weight † (kg) | Payload † (kg) | Unladen weight † (kg) | Payload † (kg) |
| <b>C20</b>                        | 2,159 1.6TDI 75PS                            | 1,075 / 1,230                   | 1,400 / 700                             | 3,550                   | 1,477                 | <b>682</b>     | 1,488                 | <b>671</b>     | 1,503                 | <b>656</b>     |
|                                   | 2,159 1.6TDI 75PS BlueMotion Technology      | 1,075 / 1,230                   | 1,400 / 700                             | 3,550                   | 1,483                 | <b>676</b>     | 1,490                 | <b>669</b>     | 1,507                 | <b>652</b>     |
|                                   | 2,159 1.6TDI 102PS                           | 1,075 / 1,230                   | 1,500 / 700                             | 3,650                   | 1,477                 | <b>682</b>     | 1,485                 | <b>674</b>     | 1,503                 | <b>656</b>     |
|                                   | 2,159 1.6TDI 102PS BlueMotion Technology     | 1,075 / 1,230                   | 1,500 / 700                             | 3,650                   | 1,483                 | <b>676</b>     | 1,490                 | <b>669</b>     | 1,507                 | <b>652</b>     |
|                                   | 2,177 1.6TDI 102PS DSG                       | 1,075 / 1,230                   | 1,500 / 710                             | 3,677                   | 1,495                 | <b>682</b>     | 1,503                 | <b>674</b>     | 1,521                 | <b>656</b>     |
|                                   | 2,177 1.6TDI 102PS DSG BlueMotion Technology | 1,075 / 1,230                   | 1,500 / 710                             | 3,677                   | 1,501                 | <b>676</b>     | 1,508                 | <b>669</b>     | 1,525                 | <b>652</b>     |
|                                   | 2,172 2.0TDI 140PS                           | 1,075 / 1,230                   | 1,500 / 710                             | 3,672                   | 1,490                 | <b>682</b>     | 1,498                 | <b>674</b>     | 1,518                 | <b>654</b>     |
|                                   | 2,172 2.0TDI 140PS BlueMotion Technology     | 1,075 / 1,230                   | 1,500 / 710                             | 3,672                   | 1,496                 | <b>676</b>     | 1,503                 | <b>669</b>     | 1,522                 | <b>650</b>     |
|                                   | 2,194 2.0TDI 140PS DSG                       | 1,075 / 1,230                   | 1,500 / 720                             | 3,694                   | 1,512                 | <b>682</b>     | 1,521                 | <b>673</b>     | 1,540                 | <b>654</b>     |
|                                   | 2,194 2.0TDI 140PS DSG BlueMotion Technology | 1,075 / 1,230                   | 1,500 / 710                             | 3,694                   | 1,518                 | <b>676</b>     | 1,525                 | <b>669</b>     | 1,544                 | <b>650</b>     |
| <b>C20+</b>                       | 2,247 1.6TDI 75PS                            | 1,075 / 1,230                   | 1,400 / 700                             | 3,550                   | 1,488                 | <b>759</b>     | 1,489                 | <b>758</b>     | 1,503                 | <b>742</b>     |
|                                   | 2,247 1.6TDI 102PS                           | 1,075 / 1,230                   | 1,500 / 700                             | 3,650                   | 1,480                 | <b>767</b>     | 1,489                 | <b>758</b>     | 1,503                 | <b>742</b>     |

Roof load limit: 100kg. Trailer nose weight: 80kg.

† Unladen weight and payload includes approximately 90% fuel load and 75kg for driver. Payload = gross vehicle weight - unladen weight.

Weights are for vehicles with standard specification. The addition of factory options or Volkswagen Van Centre fitted accessories may affect unladen weight and payload.

## Caddy panel van: Economy and performance

| Model                                  | Engine/transmission                    | Urban mpg (l/100km) <sup>1</sup> | Extra-urban mpg (l/100km) <sup>1</sup> | Combined mpg (l/100km) <sup>1</sup> | Acceleration 0-62 mph (seconds) | Top speed mph (where law permits) | CO <sub>2</sub> emissions (g/km) <sup>1</sup> |
|--|--|----------------------------------|--|-------------------------------------|---------------------------------|-----------------------------------|---|
| <b>C20</b>                             | 1.6TDI 75PS                            | 42.8 (6.6)                       | 54.3 (5.2)                             | <b>49.6 (5.7)</b>                   | 16.7                            | 93                                | <b>149</b>                                    |
|  | 1.6TDI 75PS BlueMotion Technology      | 47.9 (5.9)                       | 57.6 (4.9)                             | <b>53.3 (5.3)</b>                   | 16.7                            | 94                                | <b>139</b>                                    |
|  | 1.6TDI 102PS                           | 42.8 (6.6)                       | 54.3 (5.2)                             | <b>49.6 (5.7)</b>                   | 12.2                            | 104                               | <b>149</b>                                    |
|  | 1.6TDI 102PS BlueMotion Technology     | 47.9 (5.9)                       | 60.1 (4.7)                             | <b>55.4 (5.1)</b>                   | 12.2                            | 106                               | <b>134</b>                                    |
|  | 1.6TDI 102PS DSG                       | 42.8 (6.6)                       | 53.3 (5.3)                             | <b>48.7 (5.8)</b>                   | 12.3                            | 104                               | <b>152</b>                                    |
|  | 1.6TDI 102PS DSG BlueMotion Technology | 47.9 (5.9)                       | 54.3 (5.2)                             | <b>52.3 (5.4)</b>                   | 12.3                            | 104                               | <b>142</b>                                    |
|  | 2.0TDI 140PS                           | 38.2 (7.4)                       | 53.3 (5.3)                             | <b>47.1 (6.0)</b>                   | 10.0                            | 116                               | <b>158</b>                                    |
|  | 2.0TDI 140PS BlueMotion Technology     | 42.2 (6.7)                       | 56.5 (5.0)                             | <b>50.4 (5.6)</b>                   | 10.0                            | 116                               | <b>147</b>                                    |
|  | 2.0TDI 140PS DSG                       | 37.2 (7.6)                       | 51.4 (5.5)                             | <b>44.8 (6.3)</b>                   | 10.1                            | 116                               | <b>166</b>                                    |
| 2.0TDI 140PS DSG BlueMotion Technology | 42.8 (6.6)                             | 51.4 (5.5)                       | <b>47.9 (5.9)</b>                      | 10.1                                | 116                             | <b>155</b>                        |   |
| <b>C20+</b>                            | 1.6TDI 75PS                            | 42.8 (6.6)                       | 54.3 (5.2)                             | <b>49.6 (5.7)</b>                   | 16.7                            | 93                                | <b>149</b>                                    |
|  | 1.6TDI 102PS                           | 42.8 (6.6)                       | 54.3 (5.2)                             | <b>49.6 (5.7)</b>                   | 12.2                            | 104                               | <b>149</b>                                    |

## Caddy Maxi panel van: Dimensions and weights

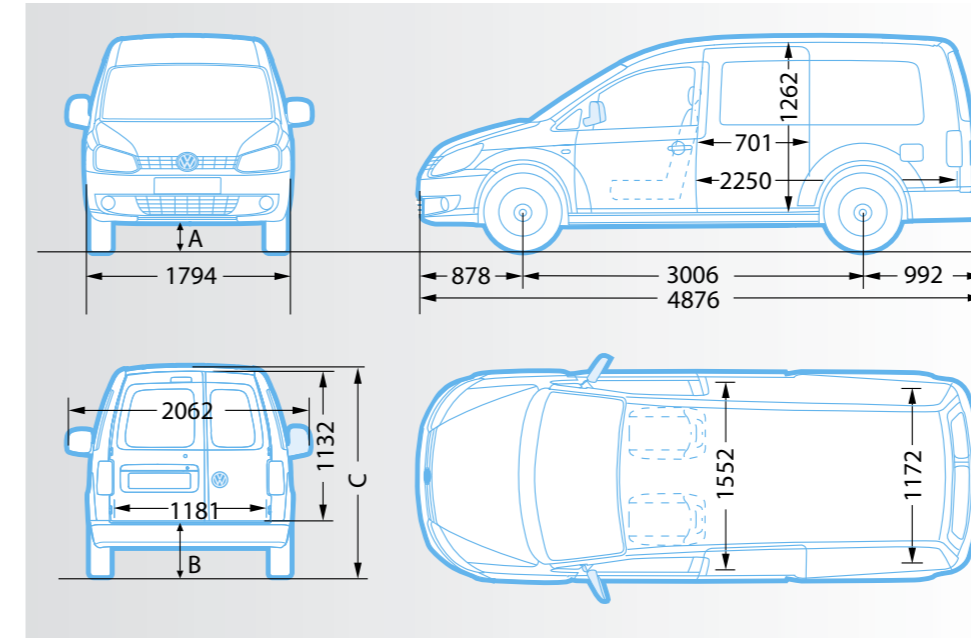

| Heights and clearances                    | Front ground clearance (A) | Rear load height (B) | Overall vehicle height (C) |
|---|----------------------------|----------------------|----------------------------|
| <b>Standard and BlueMotion Technology</b> | 157                        | 588                  | 1,836                      |
| <b>4MOTION®</b>                           | 151                        | 652                  | 1,886                      |

Dimensions A, B and C refer to diagram, left

| Dimensions                           |                   |
|--------------------------------------|-------------------|
| <b>Wheelbase</b>                     | 3,006             |
| <b>Load compartment</b>              |                   |
| Length                               | 2,250             |
| Volume                               | 4.2m <sup>3</sup> |
| <b>Side sliding door</b>             |                   |
| Width                                | 701               |
| Height                               | 1,100             |
| <b>Rear doors</b>                    |                   |
| Width                                | 1,181             |
| Height                               | 1,132             |
| <b>Turning circle (wall to wall)</b> | 12.2m             |

Dimensions in millimetres (mm) unless otherwise indicated.

| Model / gross vehicle weight (kg) | Engine/transmission | Axle load limit front/rear (kg)        | Trailer weight braked 12%/unbraked (kg) | Gross train weight (kg) | Startline             |                | Trendline             |                | Highline              |                |            |
|-----------------------------------|---------------------|--|---|-------------------------|-----------------------|----------------|-----------------------|----------------|-----------------------|----------------|------------|
|                                   |                     |  |   |                         | Unladen weight † (kg) | Payload † (kg) | Unladen weight † (kg) | Payload † (kg) | Unladen weight † (kg) | Payload † (kg) |            |
| <b>C20</b>                        | 2,310               | 1.6TDI 102PS                           | 1,125 / 1,300                           | 1,500 / 740             | 3,650                 | 1,560          | <b>750</b>            | 1,567          | <b>743</b>            | 1,585          | <b>725</b> |
|                                   | 2,310               | 1.6TDI 102PS BlueMotion Technology     | 1,125 / 1,300                           | 1,500 / 740             | 3,650                 | 1,565          | <b>745</b>            | 1,567          | <b>743</b>            | 1,589          | <b>721</b> |
|                                   | 2,328               | 1.6TDI 102PS DSG                       | 1,150 / 1,300                           | 1,500 / 750             | 3,800                 | 1,578          | <b>750</b>            | 1,585          | <b>743</b>            | 1,603          | <b>725</b> |
|                                   | 2,328               | 1.6TDI 102PS DSG BlueMotion Technology | 1,150 / 1,300                           | 1,500 / 750             | 3,800                 | 1,583          | <b>745</b>            | 1,590          | <b>738</b>            | 1,616          | <b>712</b> |
|                                   | 2,350               | 2.0TDI 110PS 4MOTION®                  | 1,200 / 1,250                           | 1,450 / 750             | 3,800                 | 1,660          | <b>690</b>            | 1,668          | <b>682</b>            | 1,685          | <b>665</b> |
|                                   | 2,327               | 2.0TDI 140PS                           | 1,150 / 1,300                           | 1,500 / 750             | 3,800                 | 1,575          | <b>752</b>            | 1,582          | <b>745</b>            | 1,602          | <b>725</b> |
|                                   | 2,327               | 2.0TDI 140PS BlueMotion Technology     | 1,150 / 1,300                           | 1,500 / 750             | 3,800                 | 1,580          | <b>747</b>            | 1,587          | <b>740</b>            | 1,607          | <b>720</b> |
|                                   | 2,349               | 2.0TDI 140PS DSG                       | 1,150 / 1,300                           | 1,500 / 750             | 3,800                 | 1,597          | <b>752</b>            | 1,604          | <b>745</b>            | 1,625          | <b>724</b> |
|                                   | 2,349               | 2.0TDI 140PS DSG BlueMotion Technology | 1,150 / 1,300                           | 1,500 / 750             | 3,800                 | 1,602          | <b>747</b>            | 1,609          | <b>740</b>            | 1,629          | <b>720</b> |

Roof load limit: 100kg. Trailer nose weight: 80kg.

† Unladen weight and payload includes approximately 90% fuel load and 75kg for driver. Payload = gross vehicle weight – unladen weight.

Weights are for vehicles with standard specification. The addition of factory options or Volkswagen Van Centre fitted accessories may affect unladen weight and payload.

<sup>1</sup> With 50% payload and fuel tank 90% full. The fuel consumption and emission test values shown are in full compliance of the fuel consumption directive 80/1268/EWG.



## Caddy Maxi panel van: **Economy and performance**

| Model                                  | Engine/transmission                    | Urban mpg (l/100km) <sup>1</sup> | Extra-urban mpg (l/100km) <sup>1</sup> | Combined mpg (l/100km) <sup>1</sup> | Acceleration 0-62 mph (seconds) | Top speed mph (where law permits) | CO <sub>2</sub> emissions (g/km) <sup>1</sup> |
|--|--|----------------------------------|--|-------------------------------------|---------------------------------|-----------------------------------|---|
| <b>C20</b>                             | 1.6TDI 102PS                           | 42.2 (6.7)                       | 53.3 (5.3)                             | <b>48.7 (5.8)</b>                   | 12.6                            | 104                               | <b>152</b>                                    |
|  | 1.6TDI 102PS BlueMotion Technology     | 47.1 (6.0)                       | 58.8 (4.8)                             | <b>54.3 (5.2)</b>                   | 12.6                            | 106                               | <b>136</b>                                    |
|  | 1.6TDI 102PS DSG                       | 42.8 (6.6)                       | 53.3 (5.3)                             | <b>48.7 (5.8)</b>                   | 12.7                            | 104                               | <b>152</b>                                    |
|  | 1.6TDI 102PS DSG BlueMotion Technology | 47.9 (5.9)                       | 54.3 (5.2)                             | <b>52.3 (5.4)</b>                   | 12.7                            | 104                               | <b>142</b>                                    |
|  | 2.0TDI 110PS 4MOTION®                  | 35.8 (7.9)                       | 61.4 (4.6)                             | <b>48.7 (5.8)</b>                   | 12.6                            | 106                               | <b>174</b>                                    |
|  | 2.0TDI 140PS                           | 37.7 (7.5)                       | 52.3 (5.4)                             | <b>46.3 (6.1)</b>                   | 10.3                            | 116                               | <b>161</b>                                    |
|  | 2.0TDI 140PS BlueMotion Technology     | 41.5 (6.8)                       | 55.4 (5.1)                             | <b>49.6 (5.7)</b>                   | 10.3                            | 116                               | <b>149</b>                                    |
|  | 2.0TDI 140PS DSG                       | 37.2 (7.6)                       | 51.4 (5.5)                             | <b>44.8 (6.3)</b>                   | 10.4                            | 116                               | <b>166</b>                                    |
| 2.0TDI 140PS DSG BlueMotion Technology | 42.8 (6.6)                             | 51.4 (5.5)                       | <b>47.9 (5.9)</b>                      | 10.4                                | 116                             | <b>155</b>                        |   |

## Caddy Maxi kombi: **Dimensions, weights, economy and performance**

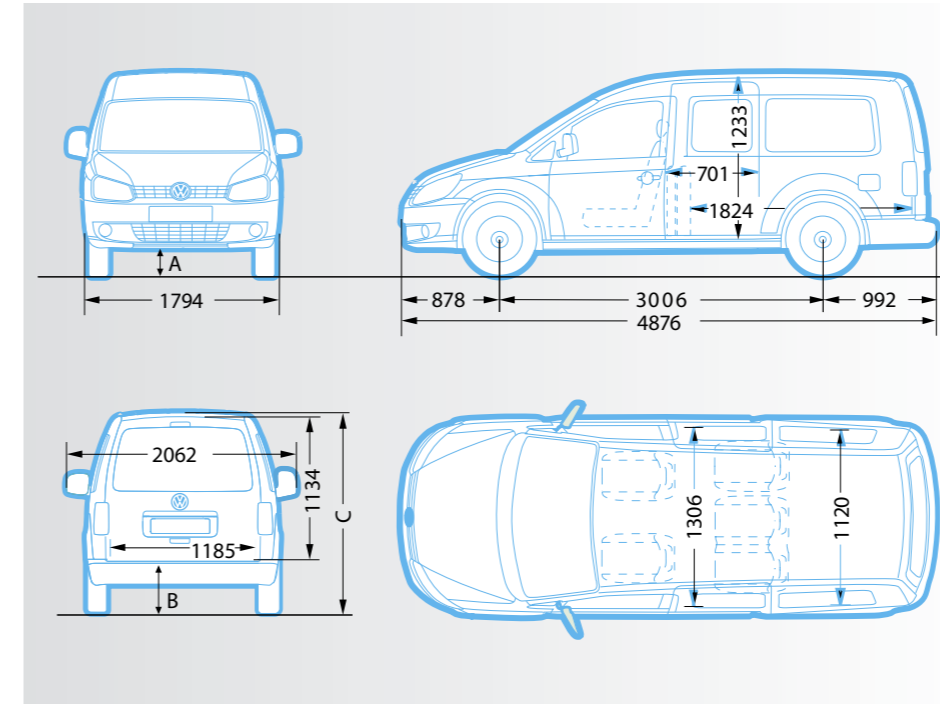

| Heights and clearances | Front ground clearance (A) | Rear load height (B) | Overall vehicle height (C) |
|------------------------|----------------------------|----------------------|----------------------------|
| <b>Standard</b>        | 160                        | 585                  | 1,831                      |

Dimensions A, B and C refer to diagram, left

| Dimensions                           |                   |
|--------------------------------------|-------------------|
| <b>Wheelbase</b>                     | 3,006             |
| <b>Load compartment volume</b>       |                   |
| With 1st row seats upright           | 1.6m <sup>3</sup> |
| With 1st row seats folded            | 3.9m <sup>3</sup> |
| With 1st row seats removed           | 4.1m <sup>3</sup> |
| <b>Sliding side door</b>             |                   |
| Width                                | 701               |
| Height                               | 1,084             |
| <b>Tailgate</b>                      |                   |
| Width                                | 1,185             |
| Height                               | 1,134             |
| <b>Turning circle (wall to wall)</b> | 12.2m             |

Dimensions in millimetres (mm) unless otherwise indicated.

| Model / gross vehicle weight (kg) | Engine/transmission | Axle load limit front/rear (kg) | Trailer weight braked 12%/unbraked (kg) | Gross train weight (kg) | Standard              |                |
|-----------------------------------|---------------------|---------------------------------|---|-------------------------|-----------------------|----------------|
|                                   |                     |                                 |   |                         | Unladen weight † (kg) | Payload † (kg) |
| <b>C20</b>                        | 1.6TDI 102PS        | 1,150 / 1,230                   | 1,500 / 750                             | 3,650                   | 1,651                 | 629            |
|                                   | 1.6TDI 102PS DSG    | 1,175 / 1,230                   | 1,500 / 750                             | 3,780                   | 1,669                 | 611            |

| Model      | Engine/transmission | Urban mpg (l/100km) <sup>1</sup> | Extra-urban mpg (l/100km) <sup>1</sup> | Combined mpg (l/100km) <sup>1</sup> | Acceleration 0-62 mph (seconds) | Top speed mph (where law permits) | CO <sub>2</sub> emissions (g/km) <sup>1</sup> |
|------------|---------------------|----------------------------------|--|-------------------------------------|---------------------------------|-----------------------------------|---|
| <b>C20</b> | 1.6TDI 102PS        | 42.8 (6.6)                       | 54.3 (5.2)                             | <b>49.6 (5.7)</b>                   | 13.4                            | 104                               | <b>149</b>                                    |
|            | 1.6TDI 102PS DSG    | 42.8 (6.6)                       | 54.3 (5.2)                             | <b>49.6 (5.7)</b>                   | 13.5                            | 104                               | <b>149</b>                                    |

Roof load limit: 100kg. Trailer nose weight: 80kg.

† Unladen weight and payload includes approximately 90% fuel load and 75kg for driver.

Payload = gross vehicle weight – unladen weight. Weights are for vehicles with standard specification. The addition of factory options or Volkswagen Van Centre fitted accessories may affect unladen weight and payload.

<sup>1</sup> With 50% payload and 80-litre fuel tank 90% full. The fuel consumption and emission test values shown are in full compliance of the fuel consumption directive 80/1268/EWG.

# Support

Keeping you – and your Caddy – on the road and working

## Full support right from the start

We want to make sure that using your Caddy is as hassle-free and cost-efficient as possible, so every vehicle comes with a three-year warranty and a choice of finance, servicing and insurance options. It all helps to keep the big issues covered

### A three-year warranty that lasts 100,000 miles

All Volkswagen Commercial Vehicles get a three-year, 100,000-mile warranty\* – and so do any factory-fit options that you buy. The vehicle warranty is made up of:

- A two-year manufacturer's warranty with unlimited mileage
- A third-year Van Centre warranty, up to a maximum of 100,000 miles\*

Even if you exceed 100,000 miles during your first two years, the manufacturer's two-year warranty will still be valid.

### Want cover for longer?

You can extend your vehicle warranty online or by phone. You can choose Comprehensive or Major Component cover and either one-off or monthly payments. Call **0845 641 9712** or visit [www.volkswagen-cv-warranty.co.uk](http://www.volkswagen-cv-warranty.co.uk).

**3**  
year  
warranty  
✓

\* Unlimited mileage for the Crafter in its third year

### Van Centres – always there for you

Our dedicated Van Centre network is at the core of everything we do, with more than 100 Van Centres and Authorised Repairers throughout the UK.

Our Van Centre network offers a wide range of services, from MOTs to accessories, servicing and fully-fitted parts. Not only that, but we use Volkswagen quality parts and you get dedicated staff who understand your vans intimately. So pop in for a coffee and a chat, and find out what your Van Centre can do for you.

### Service options designed to fit your business perfectly

It's only natural that you want to keep your vehicle running at its best. Getting it serviced at a Volkswagen Van Centre is a great way to ensure that's exactly what happens. When it comes to servicing, we know every business has different needs. That's why we've developed three different service options for you to choose from:

- Pay Monthly
- Pay Upfront
- Pay On-Demand

Whichever suits your business best, you can rest assured that when you book in your vehicle, it'll be looked at by Volkswagen-trained technicians and that they'll use only Volkswagen quality parts. What's more, there's a two-year warranty on the parts and one-year on labour.

For more details visit [www.volkswagen-vans.co.uk/service](http://www.volkswagen-vans.co.uk/service) or call **0800 717131** to learn more.

Turn the page to learn more about our Van Centre network

### Volkswagen Insurance keeps you covered\*

Volkswagen Commercial Vehicle Insurance can provide you with cost-effective, comprehensive motor insurance. Look at some of the benefits:

- Seven-day free cover to allow you to drive your vehicle away
- All repairs performed by approved repairers
- Volkswagen quality parts on all repairs
- Courtesy vehicle provided during repair following an accident
- Cover for breakage and damage to glass
- Tools-in-transit cover (up to £1,000)
- In-vehicle personal belongings cover (up to £500)
- Vehicle recovery
- 60-day European Union cover
- Legal expenses cover up to £100,000

We also offer a range of gap insurance products. These help you replace your vehicle or protect you from any financial shortfall if it is written off.

For more details visit [www.insurewithvwc.co.uk](http://www.insurewithvwc.co.uk), call **0800 316 7896** or pop into your Van Centre and ask for a Finance brochure.

\* Terms and conditions apply

### Flexible Finance that makes things affordable

We can also make buying a new van more affordable in the first place. Speak to us about our selection of finance options, which include:

- Contract hire
- Finance lease
- Lease purchase
- Hire purchase

For more details visit [www.volkswagen-vans.co.uk/finance](http://www.volkswagen-vans.co.uk/finance) or pick up one of our Finance brochures at your nearest Van Centre.

### Three years' Roadside Assistance

Sometimes, the unexpected happens. If it does, your new Volkswagen comes with an unlimited-mileage recovery and assistance package. It lasts the same three years as your warranty and operates 24 hours a day, 365 days a year.

Cover is available across the UK and most of Europe. Our fully trained technicians can diagnose most problems at the roadside and they use Volkswagen quality parts.

Learn more Visit your Van Centre to get a Volkswagen Roadside Assistance handbook, visit [www.volkswagen-vans.co.uk/roadside](http://www.volkswagen-vans.co.uk/roadside) or call **0800 77 71 72**



# 7 ways your Van Centre can help you

Make full use of your nearest Van Centre – it's full of Volkswagen experts who know your vehicle better than anyone and who can help you to get the best out of it

## 1. Picking a van that's perfect for your needs

We know that choosing your next van or passenger carrier is a big decision. You want a vehicle that works as hard as you do, both now and for the long-term – one that's versatile, cost-effective and reliable. We're here to help make your choice easier.

Our Van Centre experts can offer advice on every model in the range and help you pick the right vehicle and factory-fit options for your business. They can also advise you on the best finance packages to ensure that your payments make financial sense.



## 2. Quality servicing you'd expect at a price you wouldn't

Unpredictability and moving goalposts are part of life for a modern business, making it difficult to know how many miles your vehicle will do in a year, or how long you'll need to keep it. Our National Service Pricing is designed for customers who need the flexibility of being able to book their vehicle in for a service whenever it needs it. When you do, our technicians will do everything to ensure that your van is back on the road, working hard for your business, as soon as possible.



## 3. Fast, hassle-free van rental for one-off jobs

Need another van for just a short while? We can hire you any vehicle from our fleet – Caddy, Transporter or Crafter – or passenger-carrier versions of the Transporter and Crafter if you need to move people.

For more information, call the Van Rental team on 01908 467450

## 4. Add Ons designed to help you get more from your van

Perhaps you've bought a van and your needs have changed – maybe you need a towbar or a roof rack, or perhaps you want to give your van some extra style. That's where Add Ons comes in. Add Ons is an extensive range of Volkswagen-approved accessories, available to buy and be fitted at your local Van Centre. We've got everything from towbars to tailgate spoilers, load nets to leather seats and sat-nav systems to stunning alloy wheels.



## 5. Taking the worry out of tyres

Why run around looking for a fitter who has your tyres in stock? Let us fit new tyres when your van is in for its service and it'll keep your van off the road for less time. We have a huge range of tyres for all Volkswagen vans, from economy to premium brands, including winter tyres.



## 6. Express Visual Checks – peace of mind for free

Your Van Centre or Authorised Repairer can give your vehicle a free, 29-point Express Visual Check for complete peace of mind. You'll be given a comprehensive report, with the results clearly explained, and your technician will talk you through what work may need to be done in the future, so that you can plan ahead and budget for it. If something needs urgent attention, you can get a precise quote before any work is done – and all the Volkswagen parts are covered by a two-year warranty.

## What else can we do?

Loads! Just pop into any Van Centre and ask us. For example, we may be able to point you to a local signwriter, recharge your air-conditioning, or answer any queries about your vehicle. Whatever it may be, we're here for you.

To find your nearest Van Centre, visit [www.volkswagen-vans.co.uk](http://www.volkswagen-vans.co.uk) or call 0800 717131

## 7. Fully fitted parts for a fixed price – and not a penny more

The pricing of all our Volkswagen quality parts is straightforward and clear, so you know exactly how much you're paying. Even better, when they're fitted by trained technicians at a Van Centre or Authorised Repairer they come with two years' warranty and 12 months warranty on labour. If your van is over five years old, ask us about our Economy Parts range – a great-value way to help keep your vehicle 100% Volkswagen.



# Notes

*Scribble any queries  
you have here so you  
don't forget them*



## The small print and the footnotes

Print processes do not allow exact reproduction of the paint and upholstery colours. Some of the vehicles shown are European specification and may be fitted with optional equipment or accessories that are available at extra charge.

All data given and specifications are in accordance with information available at the time of going to print and are subject to change without notice. Vehicles not in current UK stock and customer order vehicles may take a number of weeks for delivery. Certain combinations of vehicle specifications and factory-fitted extras are not compatible and therefore all orders received are subject to confirmation. Models, factory-fitted options and paint and upholstery options subject to availability. Please check details and availability with an appropriate authorised Volkswagen Van Centre at the time of ordering.

Volkswagen Commercial Vehicle Finance is a trading name of Volkswagen Financial Services (UK) Limited. Finance subject to status, and available to over 18s only.

Full details of Volkswagen warranties are available from your authorised Volkswagen Van Centre or Van Service Centre.

Volkswagen Commercial Vehicle Insurance is a trading name of Volkswagen Insurance Service (Great Britain) Limited, an appointed representative of Volkswagen Financial Services (UK) Limited, Brunswick Court, Yeomans Drive, Blakelands, Milton Keynes MK14 5LR. Registered in England number 2835230. Volkswagen Commercial Vehicle Insurance is sold, underwritten and administered by Allianz Insurance plc registered in England number 84638. Registered office 57 Ladymead, Guildford, Surrey GU1 1DB. Volkswagen Financial Services (UK) Limited and Allianz Insurance plc are authorised and regulated by the Financial Services Authority. Volkswagen Financial Services (UK) Limited and Allianz Insurance plc are not part of the same corporate group.

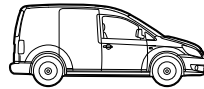

## Get in touch with the experts

To find your nearest Van Centre call

**0800 717 131**

or visit [www.volkswagen-vans.co.uk](http://www.volkswagen-vans.co.uk)

 Volkswagen\_CV

 VolkswagenCommercialVehiclesUK

**Issue: January 2014**

Printed in the UK, 2 January 2014. CVW715CADDY

This brochure supersedes all previous publications