



Das Auto.

The new Passat and Passat Estate



Contents.

- 04** Design
- 12** Interior
- 18** Driver's assistance systems
- 20** Radio and navigation systems
- 28** Passat and Passat Estate S
- 29** Passat and Passat Estate SE and SE Business
- 30** Passat and Passat Estate GT
- 32** Passat and Passat Estate R-Line
- 36** Alloy wheels
- 38** Think Blue
- 40** Paint
- 42** Upholstery
- 44** Combinations
- 50** Technical specification
- 56** Technology
- 58** Dimensions
- 62** Volkswagen service



Models shown are new Passat Estate GT 2.0 BiTDI 240 PS 4MOTION and new Passat GT 2.0 BiTDI 240 PS 4MOTION with optional 19" 'Verona' alloy wheels and metallic paint.

All-new Passat. Refined, advanced, elegant.

Confident, charismatic and sophisticated, everything about the new Passat and Passat Estate exudes confidence. Making its debut as the eighth generation of a best-selling car that has sold nearly 22 million models since 1973, the all-new Passat features advanced technologies and sophisticated assistance systems, providing new levels of comfort, luxury and performance. And that's not all. The innovative lightweight design combined with sustainable engine technology reduces emissions, operating costs and fuel consumption to new low levels, benefiting both the environment and your pocket.

With its all-new design, technologies and engines, the new Passat and Passat Estate are as versatile, progressive and sophisticated as you could wish for.



Model shown is new Passat GT 2.0 BiTDI 240 PS 4MOTION with optional 19" 'Verona' alloy wheels and metallic paint.



Model shown is new Passat Estate GT 2.0 BiTDI 240 PS 4MOTION with optional 19" 'Verona' alloy wheels and metallic paint.



Model shown is new Passat R-Line 2.0 BiTDI 240 PS 4MOTION with optional 19" 'Verona' alloy wheels and metallic paint.



Model shown is new Passat Estate GT 2.0 BiTDI 240 PS 4MOTION with optional 19" 'Verona' alloy wheels, panoramic sunroof and metallic paint.

The shape of success.

Engineering and design sets a new benchmark in the new Passat and Passat Estate. Sharp new styling includes a longer wheelbase, shorter body overhangs and a dynamic silhouette with distinctive tornado line, accented by new trapezoidal headlights and rear lights, creating an imposing road presence.

The redesigned interior complements the sophisticated exterior, with new equipment and advanced features providing new levels of comfort, convenience and luxury. Inside and out, this is functionality at its most stunning: sleek, stylish and dynamic.



Interior shown is new Passat Estate GT with optional smoking pack, net partition and metallic paint.

Sitting comfortably? Then your journey can begin.

However long or short your journey, you'll always sit comfortably in the new Passat. Stylish, durable and ergonomically designed to provide maximum comfort and support, seats are available in a range of contemporary upholsteries and leathers. Standard front seats provide manual height and lumbar adjustment, while SE models and above feature the new ergoComfort front seat for the driver, providing lumbar support, seat cushion tilt adjustment, thigh support and electric backrest adjustment, enabling you to find the optimum position for your spine easily and quickly. With the spacious new interior providing more head and legroom than ever before, there's plenty of room for family, friends and equipment, especially in the new Passat Estate. School run, weekend away or driving to work, driving has never been so easy or relaxed.

More space. More versatility. More possibilities.

Whether you're taking a business trip or going on a major shopping expedition, the new Passat and Passat Estate are designed to meet your every need. Optional keyless entry includes hands free boot or tailgate opening, which opens the boot or tailgate remotely, ideal if your hands are full, while the variable boot floor is height adjustable and removable, providing plenty of room for all your equipment or purchases. In the new Passat Estate, the load volume increases to a massive 1,780 litres with the back seats folded down, providing all the space you could ask for. Versatile, flexible and more spacious than ever, you can rely on the new Passat to keep you organised.



01 Integrated child seats are convenient, practical and easy to use, available for children weighing 15 – 36kg and up to 1.5m tall. Designed to provide optimal side support, they help ensure the safety of small occupants. Optional on all models. Image shown features optional 'Nappa' leather.

02–04 To extend the boot space, simply release the rear seat backrest either from the boot or the rear seat. The **variable boot floor** helps facilitate loading and unloading, while the optional cargo management system or optional luggage compartment divider pack keeps luggage secure. Cargo management system and luggage compartment divider pack are optional on all estate models.



Interior shown is new Passat Estate SE with optional panoramic sunroof, net partition and metallic paint.

Bring the outside in.

Enjoy the sky above like never before thanks to the new Passat's optional panoramic sunroof. Creating a well-lit, airy passenger compartment, it lets in three times more light than a conventional sunroof, and in the new Passat Estate, an additional panoramic sunroof to the rear provides even more light and space. What better way to enjoy a starry night or sunlit day? Optional on all models.



Interior shown is new Passat Estate SE with optional panoramic sunroof, net partition and 'Vienna' leather upholstery.

The intelligent way to drive.

With numerous driving assistants to help share the workload, the new Passat provides all the on-board help you could need. Smart, intelligent and capable, this is a car made for sophisticated drivers who delight in innovative technology.

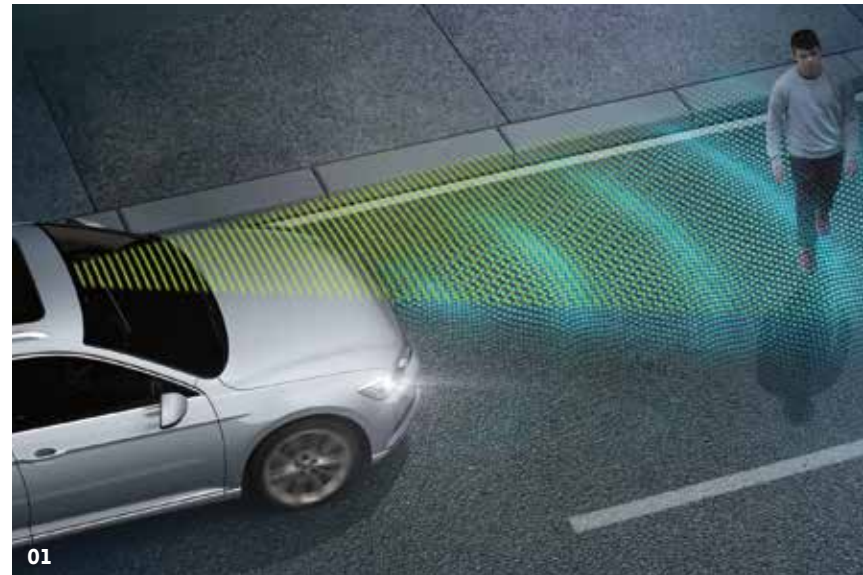

01 Predictive Pedestrian Protection, part of the optional Driver's Assistance Pack and Driver's Assistance Pack Plus, warns you if it detects, in addition to vehicles, any pedestrians at the edge of the road or on the carriageway via acoustic and optical signals as well as a gentle jolt of the brakes. It even performs an emergency stop should the distance become critical, protecting not only you but also other road users from potential accidents. Optional on SE models and above.

02 Trailer Assist. Anyone who has tried to manoeuvre a vehicle with a trailer attached understands how complicated this can be. The world's first Trailer Assist helps you reverse with a trailer attached, easily, accurately and safely. The rear-view camera shows actual and possible steering angles of the trailer in relation to the vehicle which are displayed in the instrument cluster. Reverse steering is automatic, with direction controlled via the mirror adjustment switch which acts as a joystick, while the driver controls the accelerator and brake and keeps a good look out. Optional on SE models and above. Only in conjunction with the optional swivelling towbar.

03 Traffic Jam Assist takes the stress out of driving in congested traffic by maintaining a constant distance from the vehicle in front preventing you from having to continually stop and start in slow moving traffic. The camera and radar sensor controlled system accelerates, brakes and even steers should the vehicle drift out of its lane, providing the driver maintains hold of the steering wheel. Not only does it help avoid nose-to-tail collisions, it also guides you safely through narrow sections and tight roadwork lanes. Optional on SE models and above in conjunction with DSG gearbox only. Traffic Jam Assist is part of the optional Driver's Assistance Pack Plus. Must be ordered in conjunction with optional LED premium headlights.

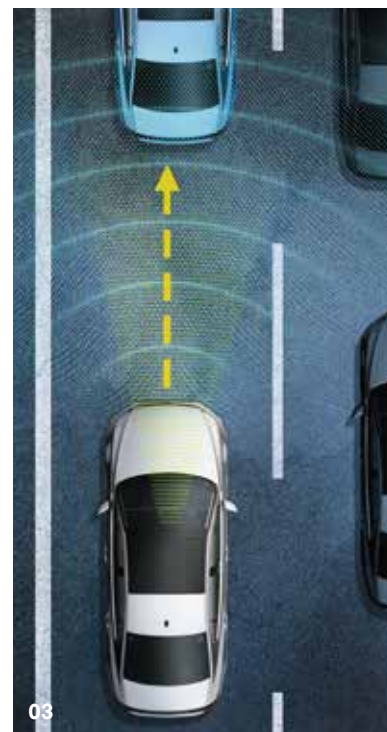

04 Area view. Four cameras located in the boot lid, door mirrors and radiator grille, each with an aperture angle of over 180 degrees, provides a 360-degree view around the new Passat helping you manoeuvre safely in any direction. From the display menu, the driver can select the camera views; front, rear, side or bird's-eye view, on either full or split-screen, displayed on the new Passat's infotainment system. Optional on SE models and above.

Please refer to your Volkswagen owner's manual for information on system parameters and official guidance on use and operation of all our technology.

Advanced acoustics. State-of-the-art navigation.



01 The **Composition Media system** is equipped with a 6.5 inch colour touch-screen with proximity sensor that recognises in advance your intention to touch the screen and automatically magnifies the display mode. Features also include DAB digital radio receiver, CD player, MDI (Multi Device Interface) via USB connection, SD card reader and SMS functionality – allowing you to read, compose and send SMS messages using the touch-screen display (compatible Android smartphones only). It also features title and compatible cover art display and facilitates music playback from MP3, WMA and AAC files through eight speakers front and rear with 4 x 20 watt output. Car information display and Think Blue. Trainer. – provide journey analysis and driver tips for more fuel efficient driving. Standard on S and SE models.



02 The **Discover Navigation touch-screen navigation/radio system** builds upon the impressive Composition Media system, but with additional features enabling you to easily manage not only your music, but also navigation data and a broad range of vehicle information. The system offers preloaded European navigation data, 2D/3D map view, three calculated route choices (Fast, Short and Eco), dynamic navigation based on TMC+, branded points of interest and Traffic Sign Display. 3-year's Car-Net 'Guide and Inform' access makes it possible to integrate 'traffic information online' into route guidance and transfer public and personal points of interest to the navigation system. The service also includes information for news and weather. Standard on SE Business models and above.

03 All the functions of Discover Navigation are included in the **Discover Navigation Pro touch-screen navigation/DVD radio system with integrated voice activation and MirrorLink™** which can be operated intuitively via the 8.0 inch TFT colour touch-screen, enabling you to manage music and navigation data. Eight powerful speakers deliver exceptional power and the DVD system is compatible with MP3 and WMA files. It also offers a 64 GB SSD hard drive, two SD card readers, photo display from JPEG and PNG files, voice control and a USB connection. The Discover Navigation Pro also features 'Guide and Inform Plus' providing online access to a range of useful information such as traffic, weather, news feeds and Google Earth. Discover Navigation Pro touch-screen navigation/DVD radio system with integrated voice activation and MirrorLink™ is optional on all models.



Concert hall acoustics. Living room luxury.



01 The **multifunction leather steering wheel with multifunction display** enables you to operate the radio and phone without taking your hands off the wheel, and GT and R-Line models equipped with automatic DSG transmission, feature paddle shift for ease of operation. A heated steering wheel is optionally available on SE models and above, along with heated front seats and heated windscreen washer jets, helping to keep the cold weather at bay. On warm days, **climate control – 3Zone electronic air conditioning** with automatic air recirculation ensures a pleasant interior temperature to suit the individual preference of driver, front and rear seat passengers. Optional on SE and standard on GT and R-Line models.

02 The **'Dynaudio Confidence'** sound system provides concert hall acoustics via a 10 channel digital amplifier, delivering 700 watts output through ten speakers optimally located around the cabin to ensure unique sound quality for every occupant. Optional on SE models and above.



02 Interior shown is new Passat GT with optional 'Dynaudio Confidence' soundpack and metallic paint.



Interior shown is new Passat GT with optional Discover Navigation Pro touch-screen navigation/DVD radio system. Screen shows Car-Net 'Guide and Inform Plus'.

Car-Net. The smart way to stay connected.



02 Whether you are using a phone, radio or radio/navigation system, **Voice activation** allows you to control everything by spoken command. Available commands are shown on the screen, and your chosen text is highlighted in red. After activation, a red symbol indicates that the instruction has been accepted. Optional on all models. Voice activation is standard on Discover Navigation Pro touch-screen navigation/DVD radio systems.



03 With **MirrorLink™**², specific apps on your Android smartphone can be mirrored on the infotainment touch-screen of your new Passat or Passat Estate. Volkswagen apps such as 'Think Blue. Trainer', 'Shared Audio', 'Drive & Track' or 'My Guide' can help to make your journey more pleasant and interesting, providing useful tips about handling your car, parking opportunities and even where to find the closest café. MirrorLink™ is included with the optional Discover Navigation Pro touch-screen navigation/DVD radio system.

¹ Car-Net 'Guide and Inform' services are accessed via a compatible mobile device. Please see www.volkswagen.co.uk for more information. The use of 'Guide and Inform' services entails exchanging large volumes of data. As such, we strongly recommend that you sign-up for a flat rate data plan with your mobile network provider. After the initial 3-year Car-Net contract, an annual subscription is chargeable for the continuation of 'Guide and Inform' services.

² Only available in connection with the Composition Media or Discover Navigation infotainment systems. MirrorLink™ apps can only be used on Android systems. Please check whether your smartphone is compatible with MirrorLink™ and observe your terms and conditions about the data and Internet connection. Consult <https://cert.mirrorlink.com/ProductListing/> to check smartphone compatibility with MirrorLink™ version 1.1.

Business or personal, practical or sporty, the choice is yours.

Versatile and adaptable, the new Passat and Passat Estate has room for your passengers, luggage and more. Depending on your requirements, five models are available: the S, SE, SE Business, GT and R-Line, each offering varying levels of trim, ranging from practical and elegant to luxurious and sporty. Whichever you select, you'll benefit from a host of advanced features and refinements.



Model shown is new Passat SE Business with optional LED premium headlights and metallic paint

Passat and Passat Estate S.



The new **Passat S** models are equipped with a whole range of innovative assistance systems fitted as standard, helping to ensure the highest levels of safety, practicality and convenience. Inside, the luxurious interior is fitted with stylish 'Hampshire' cloth upholstery, front seats with lumbar adjustment, a leather trimmed three-spoke multifunction steering wheel and gear knob, and 'Brushed Chrome' decorative inserts in the dash, centre console and door panels. Chrome-plated instrument and air vent surrounds, interior lighting with a delay and dimming function create a pleasant ambience, while the 60:40 split folding rear seat backrests (40:20:40 on estate models) offer greater flexibility when carrying luggage or loads, especially in the new Passat Estate. Image shown features optional multifunction colour display.



01 Automatic Post-Collision Braking System starts the brake operation after impact, and brakes for as long as necessary to reduce the speed of the vehicle to prevent or minimise further collisions.

02 Keyless Start enables you to start the engine using a button in the centre console, without taking the key from your pocket.

03 16 inch 'Aragon' alloy wheels with 215/60 R16 low rolling resistance tyres add a touch of refinement to the exterior of the new Passat S.



Passat and Passat Estate SE and SE Business.



The well-appointed new **Passat SE** models build on the S level specification with impressive levels of comfort and luxury and many advanced features. The refined interior is beautifully equipped with 'Kensington' cloth upholstery, an ergoComfort driver's seat with electric backrest and seat cushion tilt adjustment and front passenger's seat with height and lumbar adjustment. Front and rear carpet mats, 'Diamond Silver' decorative inserts in the dash, centre console and door panels, and LED entrance/warning lights in the front doors add further elegance and luxury, while two covered cup holders in the front and a load-through provision in the saloon's rear seat bench provide practical extra touches.

Building upon the impressive new Passat SE, the **Passat SE Business** models are equipped with an even higher level of specification, providing such features as front fog lights, heat insulating rear tinted glass, remote electrically foldable door mirrors and the Discover Navigation system with 3 years Car-Net 'Guide and Inform' internet access providing a range of information, including traffic, weather and news feeds.



01 Adaptive Cruise Control (ACC), including Front Assist radar sensor controlled distance monitoring system, City emergency braking system, cruise control and speed limiter offers you intelligent control of your driving speed by automatically adjusting acceleration and braking. Whether around town or on the motorway, the system will adjust your speed to that of the vehicle in front, keep your specified distance, warn if you are approaching too fast and, in an emergency situation, generate enough braking force to reduce the severity of a collision or even prevent the collision entirely.

02 17 inch 'London' alloy wheels with 215/55 R17 self-sealing tyres add a further touch of elegance and safety.

Interior shown is new Passat SE Business with optional Discover Navigation Pro touch-screen navigation/DVD radio system, MirrorLink™, multifunction colour display, climate control – 3Zone electronic air conditioning, 'Vienna' leather upholstery and metallic paint.



Interior shown is new Passat GT with optional Discover Navigation Pro touch-screen navigation/DVD radio system, multifunction colour display, smoking pack and metallic paint.

Passat and Passat Estate GT.



01



02



03

The new **GT models** exude exclusivity, providing the ultimate in attention to detail and craftsmanship. Inside, luxurious seats feature Alcantara seat centre section and 'Vienna' leather* side bolsters, while brushed aluminium decorative inserts in the dash and door panels, 'Piano Black' decorative inserts in the centre console and ambient lighting create elegance and style. Other luxurious features include climate control – 3Zone electronic air conditioning with automatic air recirculation, Discover Navigation system with 3 years' access to Car-Net 'Guide and Inform', remote electrically foldable door mirrors and door mirror puddle lights, and heated windscreen washer jets.

01 Front fog lights with static cornering function and chrome trimmed surround aid vision in poor weather, while enhancing the front design, and rear lights incorporating LED technology with dynamic lighting effect give a distinctive look to the rear.

02 18 inch 'Oxford Anthracite' alloy wheels with 235/45 R18 self-sealing tyres are eye-catching and sporty.

03 Heated front seats add luxury and comfort in the cold weather, giving the interior an especially warm and welcome feel in winter.

04 The new Passat GT 2.0 litre BiTDI 240 PS 4MOTION features a number of refinements, including Dynamic Chassis Control (DCC) providing a choice of Sport, Comfort and Normal settings. LED premium headlights with projection technology look sensational and include signature dual 'U-shaped' LED daytime running lights, 12 separate LEDs performing the indicator function, dynamic curve lighting and headlight washers to keep them clean. Stylish trapezoid exhaust tailpipes complete the look.



04

* Some parts of leather interior will contain artificial leather.



R-Line. Simply stunning.

Sporty, stylish and dynamic, the new Passat R-Line models have an equally impressive specification with enhanced body styling and a number of additional features, delivering even greater levels of functionality, comfort and performance. The exterior of the new R-Line is unmistakable with its distinctive 'R-Line' styling pack consisting of distinctive front and rear bumpers, radiator grille and side skirts. Front fog lights with static cornering function and chrome decorative trim and 18 inch 'Monterrey' alloy wheels complete the elegant, agile look. For those seeking the ultimate R-Line experience, the new Passat R-Line 2.0 litre BiTDI 240 PS 4MOTION provides stunning performance along with a number of additional refinements, including Dynamic Chassis Control (DCC) providing a choice of Sport, Comfort and Normal settings, LED premium headlights with projection technology, dual 'U-shaped' LED daytime running lights, 12 separate LEDs which perform the indicator function, dynamic curve lighting and headlight washers, and XDS electronic differential lock for improved traction and handling.



Models shown are new Passat Estate R-Line 2.0 BiTDI 240 PS 4MOTION and new Passat R-Line 2.0 BiTDI 240 PS 4MOTION with optional 19" 'Verona' alloy wheels and Pure White non-metallic paint.



Interior shown is new Passat R-Line 2.0 BiTDI 240 PS 4MOTION with optional Discover Navigation Pro touch-screen navigation/DVD radio system and Pure White non-metallic paint.

Designed to get your pulse racing.

Elegant and eye-catching, the new Passat R-Line is designed to get your pulse racing. The driver's ergoComfort seat and passenger's front seat feature 'Race' seat centre section and 'Vienna' leather* side bolsters, creating a luxurious and inviting interior, with the distinctive 'R-Line' logo embossed on the front head restraints, echoing the 'R-Line' logo displayed on the leather trimmed three-spoke multifunction steering wheel with aluminium inserts, stainless steel pedals and matching unique 'R-Line' carpet mats, decorative inserts and door sill protectors.

* Some parts of leather interior will contain artificial leather.



01 The **R-Line interior package** includes an ergoComfort seat for the driver with 'Race' seat centre sections and 'Vienna' leather* side bolsters, available in Titan Black/Titan Black. The unique '**R-Line**' logo on head restraints completes the sporty look.



02 18 inch '**Monterrey**' alloy wheels with 235/45 R18 self-sealing tyres give the exterior of the R-Line its powerful stance.

Alloy wheels.

Stylish alloy wheels contribute to the charismatic road presence of the new Passat and Passat Estate, with a choice of elegant or sporty designs adding a touch of individuality.



01

01 'Aragon' 6½J x 16 alloy wheels with 215/60 R16 low rolling resistance tyres and anti-theft wheel bolts. Standard on S models.

02 'London' 7J x 17 alloy wheels with 215/55 R17 self-sealing tyres and anti-theft wheel bolts. Standard on SE and SE Business models.

03 'Oxford Anthracite' 8J x 18 alloy wheels with 235/45 R18 self-sealing tyres and anti-theft wheel bolts. Standard on GT and optional on SE and SE Business models.

04 'Monterrey' 8J x 18 alloy wheels with 235/45 R18 self-sealing tyres and anti-theft wheel bolts. Standard on R-Line models.

05 'Sepang' 6½J x 16 alloy wheels with 215/60 R16 tyres and anti-theft wheel bolts. No cost option on SE and SE Business models.



02



03



04



05



06

06 'Marseille Anthracite' 8J x 18 alloy wheels with 235/45 R18 tyres and anti-theft wheel bolts. Optional on SE, SE Business and GT models.

07 'Nivelles Anthracite' 7J x 17 alloy wheels with 215/55 R17 tyres and anti-theft wheel bolts. Optional on SE and SE Business models.

08 'Soho' 7J x 17 alloy wheels with 215/55 R17 tyres and anti-theft wheel bolts. Optional on SE and SE Business models.

09 'Verona' 8J x 19 alloy wheels with 235/40 R19 tyres and anti-theft wheel bolts. Optional on GT and R-Line models.



07



08



09

Think Blue.

Sustainability + Ingenuity.

'Think Blue' is Volkswagen's promise to create progressive, environmentally friendly products and processes. So, from our concepts to our designs, from our fabrics to our machines, from our buildings to our water supply and from our engines to the open road, we can help shape a more sustainable future. We have already started by creating electric vehicles, BlueMotion models and efficient BlueMotion Technologies that save you money and reduce emissions.

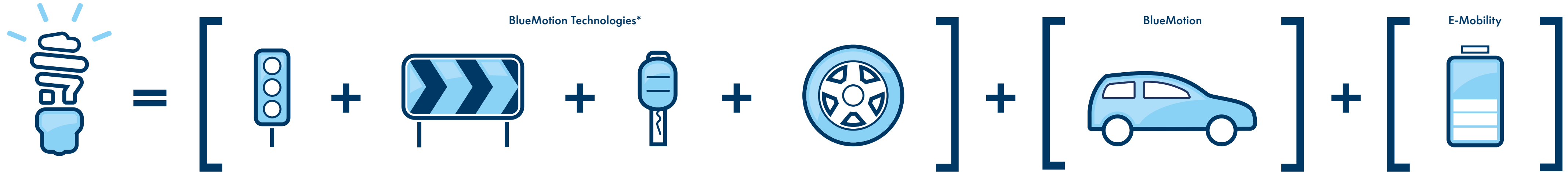

Think Blue.
Smart ideas for sustainable driving.

Start/Stop technology saves fuel and therefore cuts emissions by automatically switching off the engine when the car isn't in motion.

Brake energy recuperation system saves fuel by making the most of energy that's usually lost when you brake.

Turbocharged engines deliver more power when you need it and use less fuel when you don't.

Low rolling resistance tyres save you fuel by reducing the friction between the tyre and the road, meaning it takes less energy – and less fuel – to go further.

Purpose-built BlueMotion cars include the full range of BlueMotion Technologies as well as an aerodynamically optimised design to reduce wind resistance and increase efficiency.

Electric vehicles comprise both hybrid and fully electric vehicles, offering all the features of their regular counterparts combined with the ultimate in driving efficiency and low operating costs. The ultimate way to Think Blue.

*BlueMotion Technologies are available on all Volkswagens, excluding Phaeton, and vary between models.

Paints.

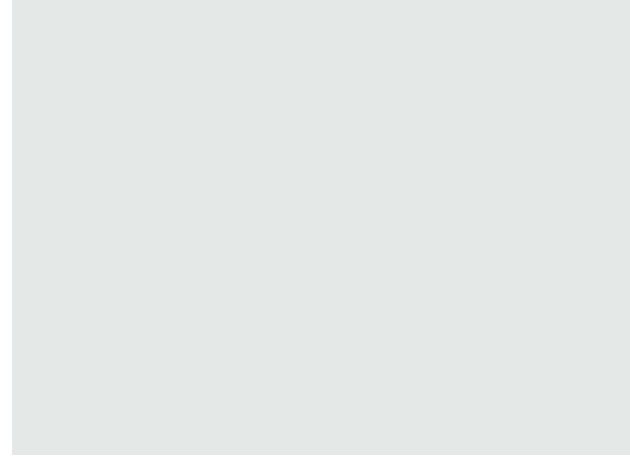

Pure White Non-Metallic* **0Q**



Urano Grey Non-Metallic **5K**



Harvard Blue Metallic* **4P**



Indium Grey Metallic* **X3**



Night Blue Metallic* **Z2**

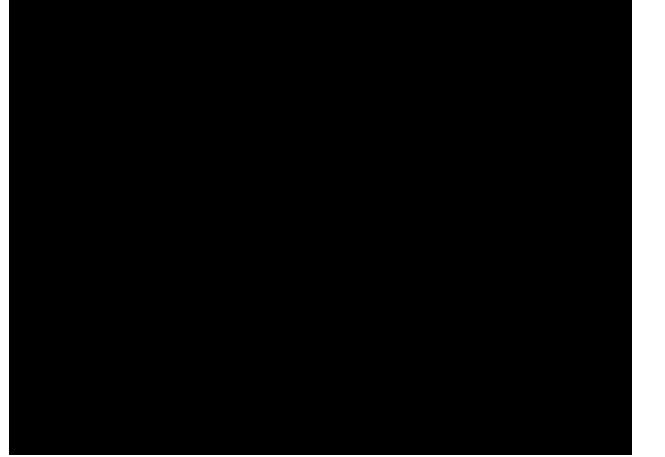

Deep Black Pearl Effect* **2T**

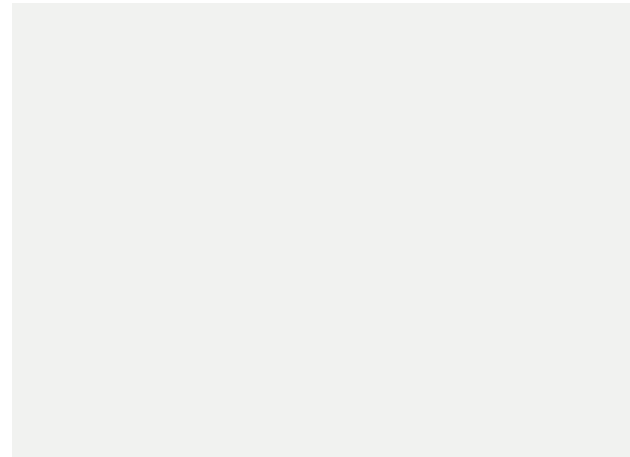

Reflex Silver Metallic* **8E**

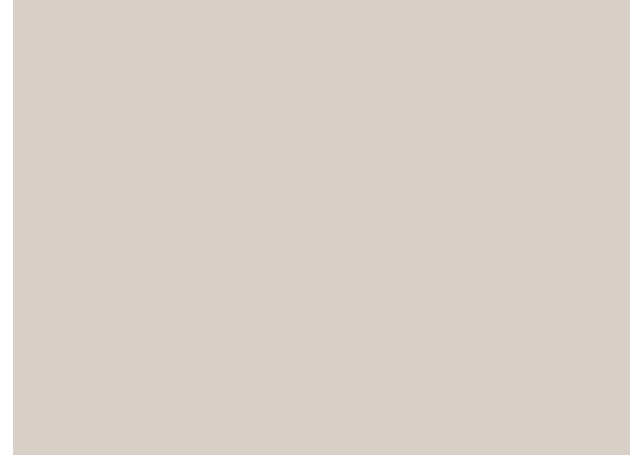

Tungsten Silver Metallic* **K5**

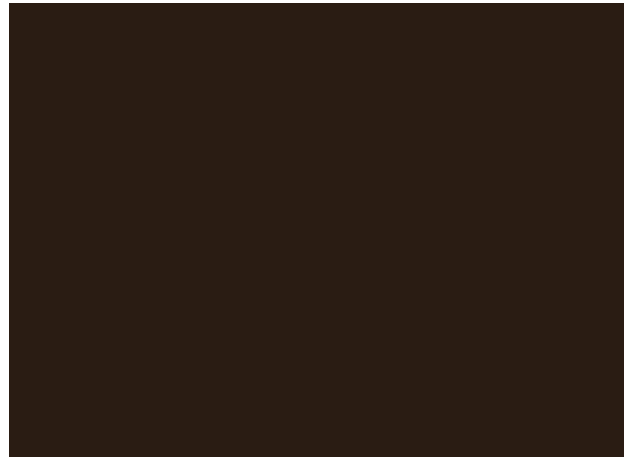

Dark Oak Brown Metallic* **P0**

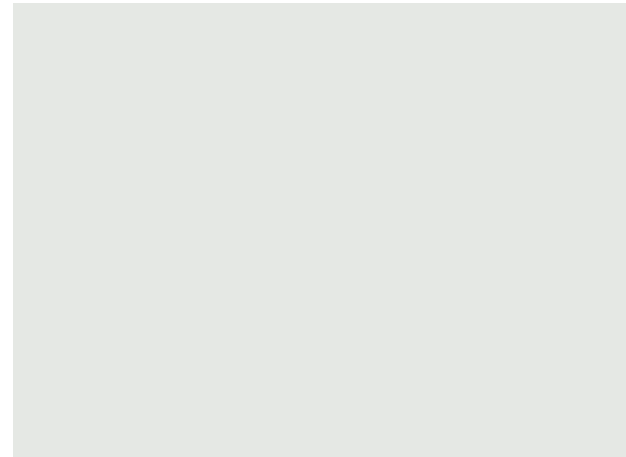

Oryx White Premium paint** **0R**



Crimson Red Premium paint* **5P**

Please note: the print processes do not allow exact reproduction of the paint colours. * Optional at extra cost. † Available to order from February 2015.

Upholstery.



'Hampshire' Cloth Titan Black TO
Standard on S models



'Kensington' Cloth Titan Black TO
Standard on SE and SE Business models



'Kensington' Cloth Espresso TQ
Standard on SE and SE Business models



'Kensington' Cloth St Tropez TS
Standard on SE and SE Business models

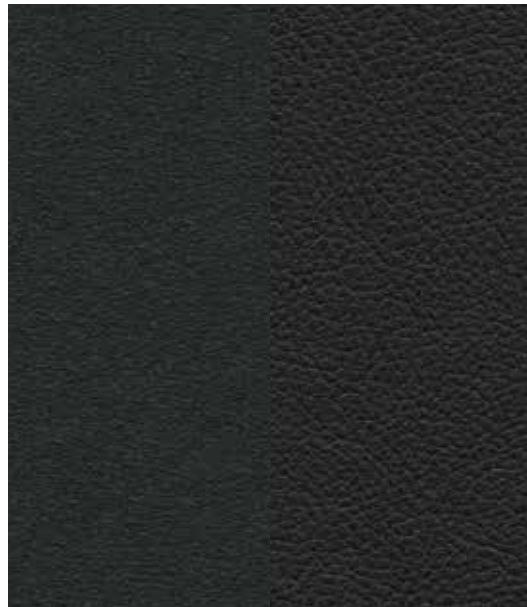

Alcantara/'Vienna' Leather* Titan Black/Titan Black TO
Standard on GT models



Alcantara/'Vienna' Leather* Espresso/Espresso TQ
Standard on GT models



Alcantara/'Vienna' Leather* St Tropez/St Tropez TS
Standard on GT models



Alcantara/'Vienna' Leather* Moonrock/Black TT
Standard on GT models



'Race' Cloth/'Vienna' Leather* Titan Black/Titan Black IN
Standard on R-Line models



'Vienna' Leather*† Titan Black TO
Optional on SE and SE Business models

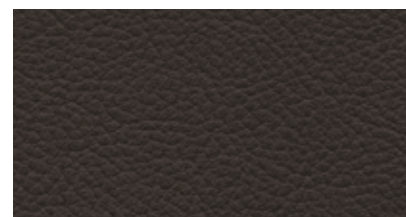

'Vienna' Leather*† Espresso TQ
Optional on SE and SE Business models



'Vienna' Leather*† St Tropez TS
Optional on SE and SE Business models

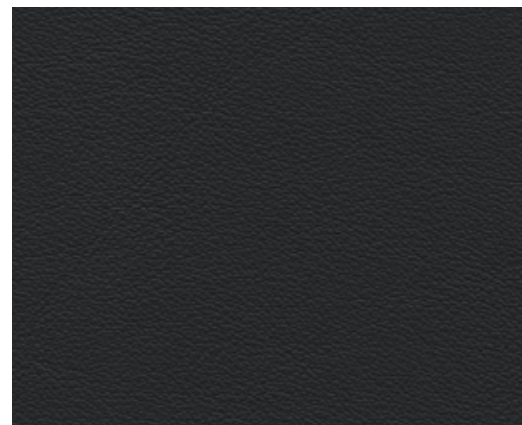

'Nappa' Leather*† Titan Black TO
Optional on GT models

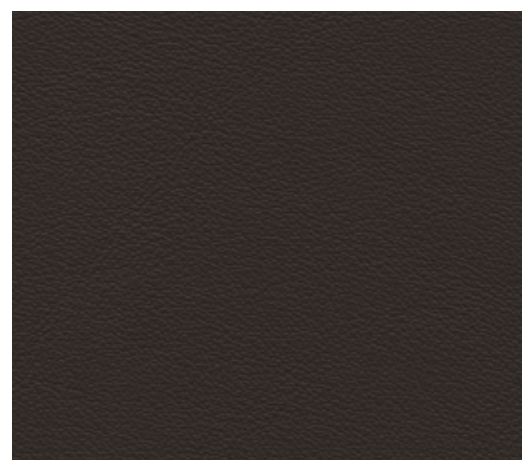

'Nappa' Leather*† Espresso TQ
Optional on GT models

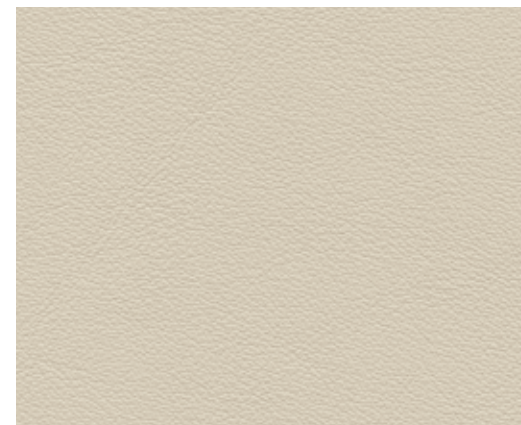

'Nappa' Leather*† St Tropez TS
Optional on GT models



'Nappa' Leather*† Marrakesh LW
Optional on GT models

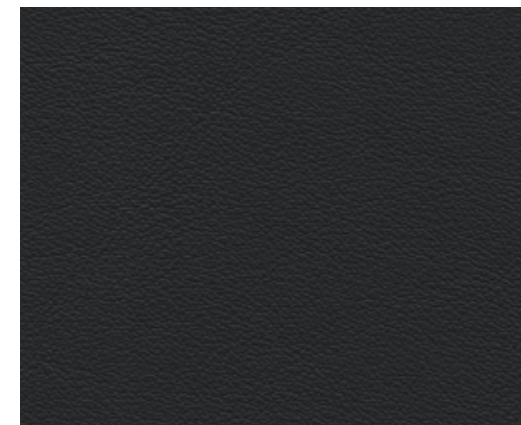

'Nappa' Leather*† Titan Black OH
Optional on R-Line models



'Nappa' Leather*† Flint Grey/Titanium Black OK
Optional on R-Line models

Please note: the print processes do not allow exact reproduction of the upholstery colours. * Some parts of leather interior will contain artificial leather. † Optional at extra cost.

Combinations.

Seat upholstery – Standard	Dashboard	Carpet	Rooflining	Pure White Non-Metallic* OQ	Urano Grey Non-Metallic 5K	Harvard Blue Metallic* 4P	Reflex Silver Metallic* 8E	Tungsten Silver Metallic* K5	Dark Oak Brown Metallic* P0	Indium Grey Metallic* X3	Night Blue Metallic* Z2	Deep Black Pearl Effect* 2T	Oryx White Premium Paint† 0R	Crimson Red Premium Paint* 5P
‘Hampshire’ cloth Standard on S Titan Black (TO)	Black	Black	St Tropez	●	●	●	●	●	●	●	●	●	●	●
‘Kensington’ cloth Standard on SE and SE Business Titan Black (TO)	Black	Black	St Tropez	●	●	●	●	●	●	●	●	●	●	●
Espresso (TQ)	Espresso	Espresso	St Tropez	●	●	●	●	●	●	●	●	●	●	–
St Tropez (TS)	Black/St Tropez	Black	St Tropez	●	●	●	●	●	●	●	●	●	●	●
Alcantara seat centre section and ‘Vienna’ leather‡ side bolsters Standard on GT Titan Black/Titan Black (TO)	Black	Black	St Tropez	●	●	●	●	●	●	●	●	●	●	●
Espresso/Espresso (TQ)	Espresso	Espresso	St Tropez	●	●	●	●	●	●	●	●	●	●	–
St Tropez/ St Tropez (TS)	Black/St Tropez	Black	St Tropez	●	●	●	●	●	●	●	●	●	●	●
Moonrock/Black (TT)	Black	Black	St Tropez	●	●	●	●	●	●	●	●	●	●	●
‘Race’ seat centre section and ‘Vienna’ leather‡ side bolsters Standard on R-Line Titan Black/Titan Black (IN)	Black	Black	Black	●	●	–	–	●	–	–	–	●	–	–

● Standard. – Not available.

* Pure White non-metallic, metallic, pearl effect and premium paints are optional at extra cost.

† Available to order from February 2015. ‡ Some parts of leather interior will contain artificial leather.

Image shown features standard ‘Kensington’ cloth in Titan Black.

Combinations.

Seat upholstery – Optional	Dashboard	Carpet	Rooflining	Pure White Non-Metallic* 0Q	Urano Grey Non-Metallic 5K	Harvard Blue Metallic* 4P	Reflex Silver Metallic* 8E	Tungsten Silver Metallic* K5	Dark Oak Brown Metallic* P0	Indium Grey Metallic* X3	Night Blue Metallic* Z2	Deep Black Pearl Effect* 2T	Oryx White Premium Paint*† OR	Crimson Red Premium Paint* 5P
‘Vienna’ leather*‡ Optional SE and SE Business														
Titan Black (TO)	Black	Black	St Tropez	○	○	○	○	○	○	○	○	○	○	○
Espresso (TQ)	Espresso	Espresso	St Tropez	○	○	○	○	○	○	○	○	○	○	–
St Tropez (TS)	Black/St Tropez	Black	St Tropez	○	○	○	○	○	○	○	○	○	○	○
‘Nappa’ leather*‡ Optional on GT														
Titan Black (TO)	Black	Black	St Tropez	○	○	○	○	○	○	○	○	○	○	○
Espresso (TQ)	Espresso	Espresso	St Tropez	○	○	○	○	○	○	○	○	○	○	–
St Tropez (TS)	Black/St Tropez	Black	St Tropez	○	○	○	○	○	○	○	○	○	○	○
Marrakesh (LW)	Black	Black	St Tropez	○	○	○	○	○	○	○	○	○	○	–
‘Nappa’ leather*‡ Optional on R-Line														
Titan Black (OH)	Black	Black	Black	○	○	–	–	○	–	–	–	○	–	–
Flint Grey/Titanium Black (OK)	Black	Black	Black	○	○	–	–	○	–	–	–	○	–	–
‘Nappa’ leather*‡ featuring climate front seats with electric 12-way adjustment and driver’s massage and memory function Optional on GT														
Titan Black (OH)	Black	Black	St Tropez	○	○	○	○	○	○	○	○	○	○	○
Espresso (TQ)	Espresso	Espresso	St Tropez	○	○	○	○	○	○	○	○	○	○	–

○ Optional at extra cost. – Not available.

* Pure White non-metallic, metallic, pearl effect and premium paints, leather upholstery and climate front seats are optional at extra cost.

† Available to order from February 2015. ‡ Some parts of leather interior will contain artificial leather.

Image shown features optional ‘Nappa’ leather in Titan Black.

There's a Volkswagen for all of us.

Nippy city run around? Luxurious executive saloon? Open-top cruiser? Whatever it is you're looking for, we probably have it. From the iconic Beetle and Golf GTI to the up! and fuel-efficient BlueMotion Golf, there's a Volkswagen for everyone.

If you're thinking you might like to try a different Volkswagen, take a look at the selection below to see what else we have. There are 21 models in our range, so there's bound to be at least one that catches your eye.



Sporty

Golf: As exciting to drive as it is to look at. Style, performance and power.

You will also find our sporty gene in the iconic Golf GTD and R. Or for something more refined and elegant, there's the Eos too.



Efficient

Our **BlueMotion** models benefit from innovative energy-saving technology that helps you optimise fuel consumption and reduce harmful emissions. This includes low rolling resistance tyres and improved aerodynamics, accompanied with advanced engines and gearboxes. Choose from the BlueMotion Polo, Golf, Golf Estate and Golf SV.

However, BlueMotion Technology can be found across our range where automatic Start/Stop technology and brake energy recuperation is standard on the majority of our engines, helping you to save more money by being more efficient.



Spacious family cars

Sharan: The ultimate in convenience with sliding rear doors, and enough space for the whole family. And their luggage. And the dogs.

If it's space you're after, then you might also like to consider the Tiguan, Golf SV, Golf Estate, Touran and new Passat Estate.



Style

Beetle: The original icon. And still the most unique way to make a fashion statement.

For more fun with the top down, why not consider Beetle Cabriolet, Golf Cabriolet or Eos.



City run around

up!: The ideal city car. Efficient, fun and surprisingly spacious, with that trademark Volkswagen solidity.

If you're looking for something slightly more spacious, then why not consider the up!'s bigger sibling, the Polo. City run around efficiency with more versatility and even more space can be found on the iconic Golf – winner of 'World Car of the Year 2013'.



Executive

Volkswagen CC: Perfectly turned out high-tech, executive luxury. A contemporary, stylish and innovative coupé.

All the luxury you need can also be found in the top of the range Phaeton, and executive comfort in the new Passat, new Passat Estate and Jetta.



4x4

New Touareg: The SUV just got smarter. True four by four capability off-road, and smooth, luxurious and powerful when on it. Features four wheel drive technology, '4MOTION', as standard for optimum road grip, stability and control.

Go anywhere, do anything in our four wheel drive alternatives: Tiguan and new Passat and Estate 4MOTION models.

To see these models and configure your ideal Volkswagen, visit: www.volkswagen.co.uk



Model shown is new Passat Estate R-Line 2.0 BiTDI 240 PS 4MOTION with optional 19" 'Verona' alloy wheels and metallic paint.

Built for performance. And economy.

The new 2.0 litre BiTDI 240 PS 4MOTION with DSG gearbox produces a massive 500Nm of torque, accelerating the new Passat saloon from 0-62mph in just 6.1 seconds and the estate model in a respectable 6.3 seconds. And not only is it fast, it's economical too. Thanks to a new lightweight design that's 85kg lighter than the outgoing model, allied with the latest sustainable engine technology, the new Passat incurs lower operating and fuel costs than ever before, while sustainable technology reduces CO₂ emissions to new low levels. Designed to benefit your pocket and the environment, the new Passat and Passat Estate deliver phenomenal results, whichever engine you select.

Technical specification – Passat Saloon.

	S, SE, SE Business 1.6 ltr TDI 120 PS BlueMotion Technology	GT 1.6 ltr TDI 120 PS BlueMotion Technology	S, SE, SE Business 2.0 ltr TDI 150 PS BlueMotion Technology	GT, R-Line 2.0 ltr TDI 150 PS BlueMotion Technology	GT, R-Line 2.0 ltr TDI SCR 190 PS BlueMotion Technology	GT, R-Line 2.0 ltr BITDI SCR 240 PS BlueMotion Technology 4MOTION
Engine						
Engine type	4 cylinder diesel	4 cylinder diesel	4 cylinder diesel	4 cylinder diesel	4 cylinder diesel	4 cylinder diesel
Cubic capacity, ltrs/cc	1.6/1598	1.6/1598	2.0/1968	2.0/1968	2.0/1968	2.0/1968
Max. output, PS ⁽⁰¹⁾ /kW	120/88	120/88	150/110	150/110	190/140	240/176
at rpm	3600-4000	3600-4000	3500-4000	3500-4000	3500-4000	4000
Max. torque, lbs.ft/Nm	185/250	185/250	251/340	251/340	295/400	369/500
at rpm	1750-3500	1750-3500	1750-3000	1750-3000	1750-3000	1750-2500
Gearbox	6-spd manual 7-spd auto DSG	6-spd manual 7-spd auto DSG	6-spd manual 6-spd auto DSG	6-spd manual 6-spd auto DSG	6-spd manual 6-spd auto DSG	– 7-spd auto DSG
Weights, kgs						
Manual gearbox:						
Unladen weight ⁽⁰²⁾	1444	1444	1475	1475	TBA	–
Gross vehicle weight	1990	1990	2020	2020	TBA	–
Payload ⁽⁰²⁾	621	621	620	620	TBA	–
Axle load limit: Front	1060	1060	1070	1070	TBA	–
Rear	980	980	1000	1000	TBA	–
Automatic DSG gearbox:						
Unladen weight ⁽⁰²⁾	1459	1459	1501	1501	1549	1721
Gross vehicle weight	2000	2000	2040	2040	2110	2260
Payload ⁽⁰²⁾	616	616	614	614	636	614
Axle load limit: Front	1070	1070	1090	1090	1100	1160
Rear	980	980	1000	1000	1060	1150
Trailer load limits, kgs⁽⁰³⁾						
Braked 12% incline:						
Manual gearbox	1500	1500	2000	2000	TBA	–
Automatic DSG gearbox	1500	1500	2000	2000	2000	2200
Unbraked:						
Manual gearbox	720	720	730	730	TBA	–
Automatic DSG gearbox	720	720	750	750	750	750
Towbar load limit	90	90	90	90	90	90
Max. roof load	100	100	100	100	100	100

	S, SE, SE Business 1.6 ltr TDI 120 PS BlueMotion Technology	GT 1.6 ltr TDI 120 PS BlueMotion Technology	S, SE, SE Business 2.0 ltr TDI 150 PS BlueMotion Technology	GT, R-Line 2.0 ltr TDI 150 PS BlueMotion Technology	GT, R-Line 2.0 ltr TDI SCR 190 PS BlueMotion Technology	GT, R-Line 2.0 ltr BITDI SCR 240 PS BlueMotion Technology 4MOTION
Performance						
Top speed, mph (km/h), where the law permits						
Manual gearbox	128 (206)	128 (206)	136 (220)	136 (220)	TBA	–
Automatic DSG gearbox	128 (206)	128 (206)	135 (218)	135 (218)	146 (235)	149 (240)
Acceleration, secs 0 – 62mph						
Manual gearbox	10.8	10.8	8.7	8.7	TBA	–
Automatic DSG gearbox	10.8	10.8	8.7	8.7	7.7	6.1
ABl insurance group, 1 - 50	15E, 12E, 12E	13E	21E, 19E, 19E	19E, 19E	22E, 23E	28E, 28E
Environmental information						
Fuel grade, minimum	Diesel ⁽⁰⁴⁾	Diesel ⁽⁰⁴⁾	Diesel ⁽⁰⁴⁾	Diesel ⁽⁰⁴⁾	Diesel ⁽⁰⁴⁾	Diesel ⁽⁰⁴⁾
Fuel tank capacity, galls/ltrs ⁽⁰⁵⁾	12/59	12/59	14/66	14/66	14/66	14/66
Official fuel consumption manual gearbox, mpg/ltr per 100km ⁽⁰⁶⁾						
Urban	60.1/4.7	57.7/4.9	60.1/4.7	58.9/4.8	TBA	–
Extra-urban	78.5/3.6	74.3/3.8	78.5/3.6	74.3/3.8	TBA	–
Combined	70.6/4.0	67.3/4.2	70.6/4.0	68.9/4.1	TBA	–
Official fuel consumption automatic DSG gearbox, mpg/ltr per 100km ⁽⁰⁶⁾						
Urban	62.8/4.5	61.4/4.6	54.3/5.2	53.3/5.3	52.3/5.4	44.1/6.4
Extra-urban	76.4/3.7	72.4/3.9	70.6/4.0	68.9/4.1	68.9/4.1	61.4/4.6
Combined	70.6/4.0	68.9/4.1	64.2/4.4	62.8/4.5	61.4/4.6	53.3/5.3
Official CO ₂ emission, g/km						
Manual gearbox ⁽⁰⁷⁾	105	109	106	109	107 [†]	–
Automatic DSG gearbox ⁽⁰⁷⁾	103	106	116	119	119	139
Emission class	EURO 6	EURO 6	EURO 6	EURO 6	EURO 6	EURO 6
Noise, dB						
Manual gearbox	TBA	TBA	TBA	TBA	TBA	–
Automatic DSG gearbox	TBA	TBA	TBA	TBA	TBA	TBA

[†] The CO₂ figure quoted is a provisional figure which has yet to be confirmed. A change to this figure may result in a change to the Manufacturer's Recommended 'On the road' Retail price. Please consult your Volkswagen retailer for full details.
SCR (Selective Catalytic Reduction) requires AdBlue®, please see www.volkswagen.co.uk/technology/adblue for more details.

Technical specification – Passat Estate.

	S, SE, SE Business 1.6 ltr TDI 120 PS BlueMotion Technology	GT 1.6 ltr TDI 120 PS BlueMotion Technology	S, SE, SE Business 2.0 ltr TDI 150 PS BlueMotion Technology	GT, R-Line 2.0 ltr TDI 150 PS BlueMotion Technology	GT, R-Line 2.0 ltr TDI SCR 190 PS BlueMotion Technology	GT, R-Line 2.0 ltr BiTDI SCR 240 PS BlueMotion Technology 4MOTION
Engine						
Engine type	4 cylinder diesel	4 cylinder diesel	4 cylinder diesel	4 cylinder diesel	4 cylinder diesel	4 cylinder diesel
Cubic capacity, ltrs/cc	1.6/1598	1.6/1598	2.0/1968	2.0/1968	2.0/1968	2.0/1968
Max. output, PS ⁽⁰¹⁾ /kW	120/88	120/88	150/110	150/110	190/140	240/176
at rpm	3600-4000	3600-4000	3500-4000	3500-4000	3500-4000	4000
Max. torque, lbs.ft/Nm	185/250	185/250	251/340	251/340	295/400	369/500
at rpm	1750-3500	1750-3500	1750-3000	1750-3000	1750-3000	1750-2500
Gearbox	6-spd manual 7-spd auto DSG	6-spd manual 7-spd auto DSG	6-spd manual 6-spd auto DSG	6-spd manual 6-spd auto DSG	6-spd manual 6-spd auto DSG	– 7-spd auto DSG
Weights, kgs						
Manual gearbox:						
Unladen weight ⁽⁰²⁾	1485	1485	1505	1505	TBA	–
Gross vehicle weight	2060	2060	2070	2070	TBA	–
Payload ⁽⁰²⁾	650	650	640	640	TBA	–
Axle load limit: Front	1040	1040	1050	1050	TBA	–
Rear	1070	1070	1070	1070	TBA	–
Automatic DSG gearbox:						
Unladen weight ⁽⁰²⁾	1500	1500	1541	1541	1581	1735
Gross vehicle weight	2060	2060	2130	2130	2170	2310
Payload ⁽⁰²⁾	635	635	664	664	664	650
Axle load limit: Front	1050	1050	1100	1100	1100	1140
Rear	1060	1060	1080	1080	1120	1220
Trailer load limits, kgs⁽⁰³⁾						
Braked 12% incline:						
Manual gearbox	1500	1500	2000	2000	TBA	–
Automatic DSG gearbox	1500	1500	2000	2000	2000	2200
Unbraked:						
Manual gearbox	740	740	750	750	TBA	–
Automatic DSG gearbox	750	750	750	750	750	750
Towbar load limit	90	90	90	90	90	90
Max. roof load	100	100	100	100	100	100

	S, SE, SE Business 1.6 ltr TDI 120 PS BlueMotion Technology	GT 1.6 ltr TDI 120 PS BlueMotion Technology	S, SE, SE Business 2.0 ltr TDI 150 PS BlueMotion Technology	GT, R-Line 2.0 ltr TDI 150 PS BlueMotion Technology	GT, R-Line 2.0 ltr TDI SCR 190 PS BlueMotion Technology	GT, R-Line 2.0 ltr BiTDI SCR 240 PS BlueMotion Technology 4MOTION
Performance						
Top speed, mph (km/h), where the law permits						
Manual gearbox	127 (204)	127 (204)	135 (218)	135 (218)	TBA	–
Automatic DSG gearbox	127 (204)	127 (204)	134 (216)	134 (216)	144 (233)	147 (238)
Acceleration, secs 0 – 62mph						
Manual gearbox	11.0	11.0	8.9	8.9	TBA	–
Automatic DSG gearbox	11.0	11.0	8.9	8.9	7.9	6.3
ABl insurance group, 1 - 50	15E, 12E, 12E	13E	21E, 19E, 19E	19E, 19E	22E, 23E	28E, 28E
Environmental information						
Fuel grade, minimum	Diesel ⁽⁰⁴⁾	Diesel ⁽⁰⁴⁾	Diesel ⁽⁰⁴⁾	Diesel ⁽⁰⁴⁾	Diesel ⁽⁰⁴⁾	Diesel ⁽⁰⁴⁾
Fuel tank capacity, galls/ltrs ⁽⁰⁵⁾	12/59	12/59	14/66	14/66	14/66	14/66
Official fuel consumption manual gearbox, mpg/ltr per 100km ⁽⁰⁶⁾						
Urban	58.9/4.8	57.6/4.9	58.9/4.8	57.6/4.9	TBA	–
Extra-urban	76.3/3.7	74.3/3.8	76.3/3.7	74.3/3.8	TBA	–
Combined	68.9/4.1	67.3/4.2	68.9/4.1	67.3/4.2	TBA	–
Official fuel consumption automatic DSG gearbox, mpg/ltr per 100km ⁽⁰⁶⁾						
Urban	62.8/4.5	61.4/4.6	53.3/5.3	51.4/5.5	52.3/5.4	43.5/6.5
Extra-urban	76.3/3.7	72.4/3.9	68.9/4.1	65.7/4.3	68.9/4.1	60.1/4.7
Combined	70.6/4.0	68.9/4.1	62.8/4.5	60.1/4.7	61.4/4.6	52.3/5.4
Official CO ₂ emission, g/km						
Manual gearbox ⁽⁰⁷⁾	107	110	107	110	109†	–
Automatic DSG gearbox ⁽⁰⁷⁾	104	107	119	122	120	140
Emission class	EURO 6	EURO 6	EURO 6	EURO 6	EURO 6	EURO 6
Noise, dB						
Manual gearbox	TBA	TBA	TBA	TBA	TBA	–
Automatic DSG gearbox	TBA	TBA	TBA	TBA	TBA	TBA

† The CO₂ figure quoted is a provisional figure which has yet to be confirmed. A change to this figure may result in a change to the Manufacturer's Recommended 'On the road' Retail price. Please consult your Volkswagen retailer for full details.
SCR (Selective Catalytic Reduction) requires AdBlue®, please see www.volkswagen.co.uk/technology/adblue for more details.

Technology.

Technical specification notes

- 01) The maximum power output figures are quoted in PS (or Pferdestärke, which is the metric equivalent of horsepower). To convert from metric to imperial horsepower, divide the PS figure by 1.0139.
- 02) Figures are calculated in accordance with manufacturer's criteria. The individual unladen weight depends on the specification of the vehicle, this then reduces the possible payload accordingly. The unladen weight and payload both include the fuel tank 90% full, driver (68kg) and luggage (7kg) in line with EU directive 95/48.
- 03) With increasing altitude the engine performance diminishes. From 1,000m above sea level and for every 1,000m thereafter 10% of the vehicle/trailer weight (trailer weight + gross vehicle weight) must be deducted.
- 04) The use of 100% RME and FAME (bio diesel) is not possible. Forecourt diesel with up to 7% bio diesel content, adhering to standard BS EN 590, can be used in diesel engines. The use of ethanol in forecourt petrol meeting BS EN 228 is allowable.
- 05) The size of the fuel tank is approximate and therefore it may be possible to add a greater amount of fuel than the size of the tank specified, due to the space in the filler neck.
- 06) Fuel consumption and CO₂ figures are obtained under standardised EU test conditions (Directive 93/116/EEC). This allows a direct comparison between different manufacturer models but may not represent the actual fuel consumption achieved in 'real world' driving conditions. More information is available on the Volkswagen web site at www.volkswagen.co.uk and at www.vca.gov.org.
- 07) The weight of a vehicle will influence the level of CO₂ emission it produces; as a result, vehicles with higher levels of specification and factory-fitted options may emit higher levels of CO₂.

Transmission

- Electronic differential lock, combined with a hydraulically operated single-plate dry clutch with asbestos-free lining via a six manual or six and seven speed automatic DSG gearbox
- Front wheel drive through asbestos-free single-plate dry clutch. Hydraulic clutch-mechanism. Six speed manual, six or seven speed automatic DSG gearbox with double joint half axles (wet clutch on six speed DSG models)
- Four wheel drive, 4MOTION: Seven speed automatic DSG 2.0 litre BiTDi SCR 240 PS

Running gear

- ESC (Electronic Stability Control) including EDL (Electronic Differential Lock), ASR (Traction Control), EDTC (Engine Drag Torque Control) and Countersteer Support with trailer stabilisation function
- Front suspension through coil springs with telescopic shock absorbers, all elements integrated in chassis legs
- Rear suspension with gas pressure shock absorbers and separate springs
- Multilink rear axle
- Wheel control: front through chassis legs and (lower) triangular wishbones (directionally stabilising steering roll radius)
- Wheel control: rear through four-link suspension with independent wheel suspension
- Front and rear anti-roll bar
- XDS electronic differential lock (2.0 litre BiTDi SCR 240 PS 4MOTION only)

Steering

- Electro-mechanical steering rack
- Collapsible, height and lengthways adjustable safety steering column

Brakes

- Electronically controlled Anti-lock Braking System (ABS) with Electronic Brake-pressure Distribution (EBD)
- Diagonal twin-circuit brake system with ventilated front disc brakes and rear disc brakes
- Asbestos-free brake pad
- HBA (Hydraulic Brake Assist)

Engines

- Front transverse-installed engine
- 1.6 litre/120 PS⁽⁰¹⁾ (88 kW) common rail diesel engine: EU6 emissions standard, four cylinder in-line common rail diesel engine, with four valves per cylinder. Fitted with a turbocharger and a DPF (diesel particulate filter). Available with a six speed manual or a seven speed automatic DSG transmission
- 2.0 litre/150 PS⁽⁰¹⁾ (110 kW) common rail diesel engine: EU6 emissions standard, four cylinder in-line common rail diesel engine, with four valves per cylinder. Fitted with a turbocharger and a DPF (diesel particulate filter). Available with a six speed manual or a six speed automatic DSG transmission
- 2.0 litre/190 PS⁽⁰¹⁾ (140 kW) common rail diesel engine: EU6 emissions standard, four cylinder in-line common rail diesel engine, with four valves per cylinder. Fitted with a turbocharger and a DPF (diesel particulate filter) with SCR (Selective Catalytic Reduction). Available with a six speed manual or a six speed automatic DSG transmission
- 2.0 litre/240 PS⁽⁰¹⁾ (176 kW) common rail diesel engine: EU6 emissions standard, four cylinder in-line common rail diesel engine, with four valves per cylinder. Fitted with a turbocharger and a DPF (diesel particulate filter) with SCR (Selective Catalytic Reduction). BiTurbo second turbocharger or supercharger. Available with a seven speed automatic DSG transmission

SCR (Selective Catalytic Reduction) requires AdBlue®, please see www.volkswagen.co.uk/technology/adblue for more details.



Dimensions.

Exterior dimensions	New Passat Saloon
Length, mm	4767
Width – including door mirrors, mm	2083
Width – opened front/rear doors, mm	3798/3685
Height – mm	1456
Height – opened bonnet/floor, mm	1782
Height – opened tailgate/floor, mm	1747
Wheelbase, mm	2791
Turning circle, m	11.7

Interior dimensions	
Effective headroom – front, mm (with sunroof)	989 (977)
Effective headroom – rear, mm (with sunroof)	964 (964)
Elbow width, front, mm	1506
Elbow width, rear, mm	1506
Legroom front, mm	1045
Legroom rear, mm	973

Maximum luggage capacity, litres VDA measuring method using 200 x 100 x 50mm blocks	
With rear seats upright	586
With rear seats folded	1152

On illustrations, where arrows and figures are shown inside of the vehicle, the measurements are for interior dimensions. Where arrows and figures are shown outside of the vehicle, the measurements are for exterior dimensions.

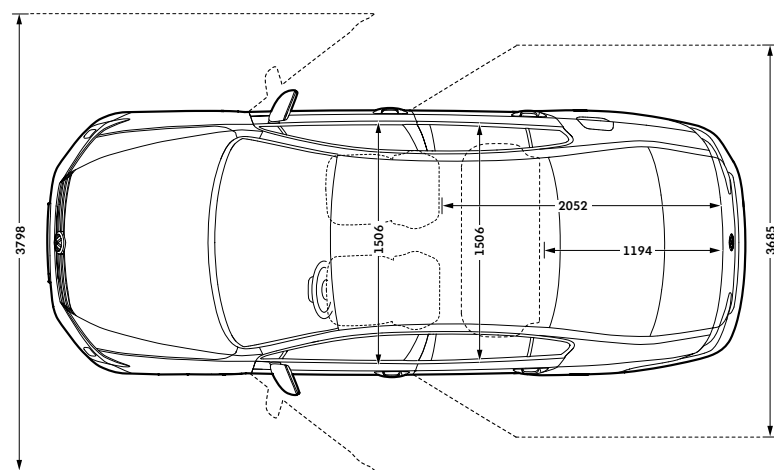
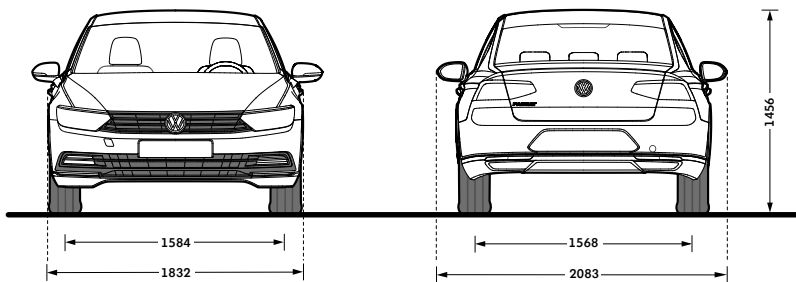
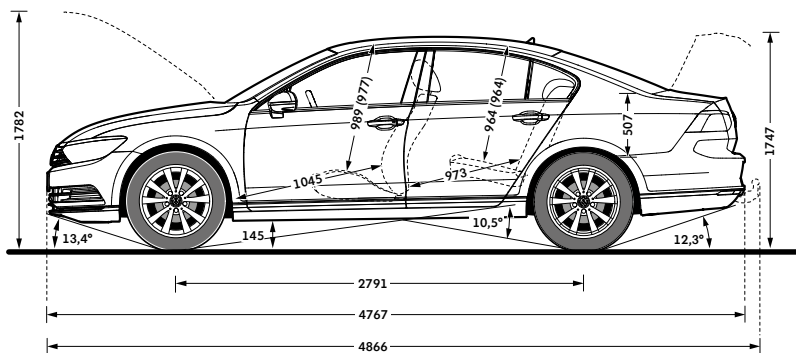

Exterior dimensions	New Passat Estate
Length, mm	4767
Width – including door mirrors, mm	2083
Width – opened front/rear doors, mm	3798/3594
Height – mm	1477
Height – opened bonnet/floor, mm	1782
Height – opened tailgate/floor, mm	2047
Wheelbase, mm	2791
Turning circle, m	11.7

Interior dimensions	
Effective headroom – front, mm (with sunroof)	985 (949)
Effective headroom – rear, mm (with sunroof)	1007 (972)
Elbow width, front, mm	1506
Elbow width, rear, mm	1506
Legroom front, mm	1045
Legroom rear, mm	973

Maximum luggage capacity, litres VDA measuring method using 200 x 100 x 50mm blocks	
With rear seats upright	650
With rear seats folded	1780

On illustrations, where arrows and figures are shown inside of the vehicle, the measurements are for interior dimensions. Where arrows and figures are shown outside of the vehicle, the measurements are for exterior dimensions.

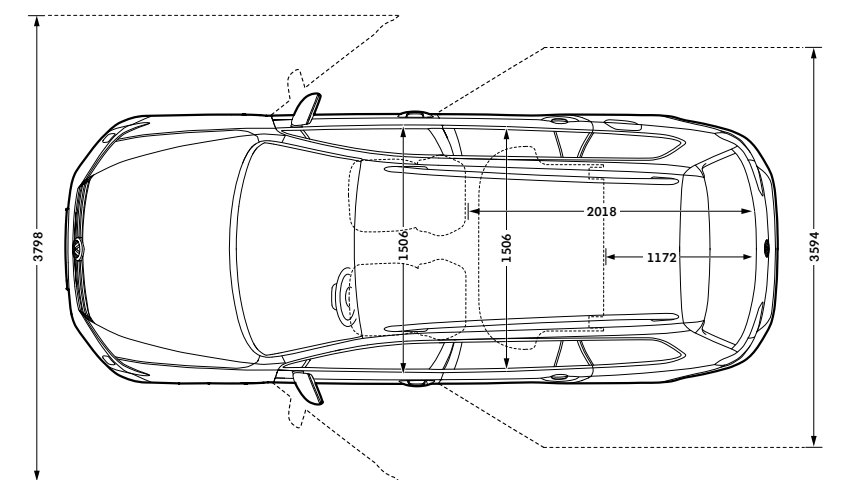
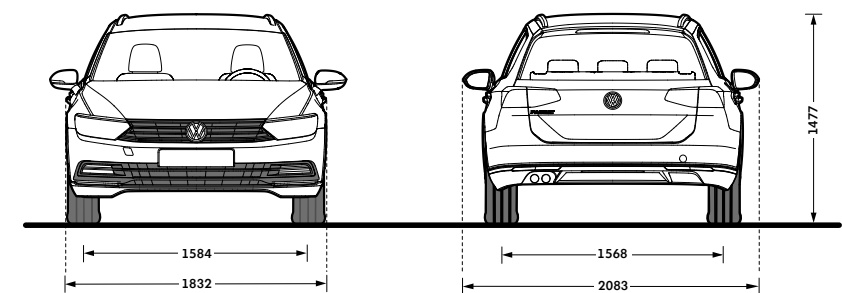
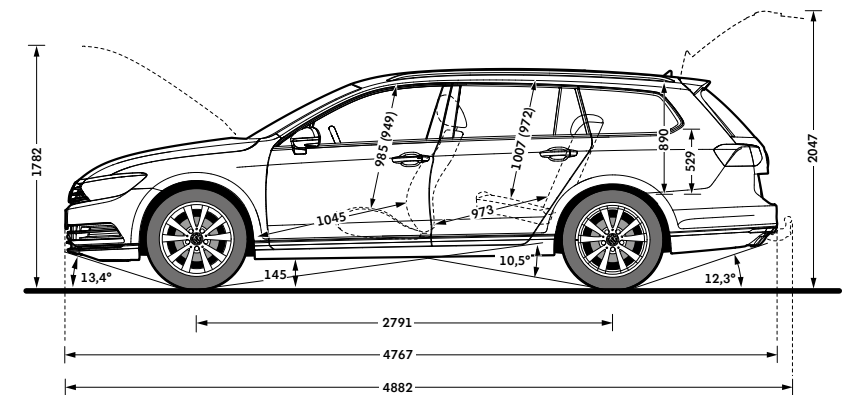

**The new Passat.
Just waiting to be driven.**



Model shown is new Passat GT 2.0 BiTDI 240 PS 4MOTION with optional 19" 'Verona' alloy wheels and metallic paint.

Volkswagen service.

Three-year Warranty

All Volkswagen passenger cars come with a three-year/60,000 miles warranty, which protects your car against the failure of most technical and electrical components due to manufacturing defects. This comprises a two-year manufacturer's warranty with unlimited mileage plus a further one-year/60,000 miles (whichever is soonest) Retailer Warranty¹. Should the mileage exceed 60,000 miles within the first two years, the manufacturer's two-year warranty will still be valid. Full details of the three-year warranty are available from your authorised Volkswagen retailer or repairer.

Body Protection Warranty

The internal body sections and panels of the Passat are covered against rusting through from the inside for 12 years. Naturally, the vehicle must be cared for in compliance with the operating instructions. Please consult your authorised Volkswagen retailer or repairer for full warranty details.

Three-year Paintwork Warranty

This latest warranty, pioneered by Volkswagen, really provides you with the widest possible cover on a new car. There are no special conditions attached and paintwork manufacturing defects will be rectified without charge. Naturally, during the warranty period the car must be cared for in compliance with the operating instructions.

Approved Accessories

A comprehensive range of accessories from alloy wheels to carpet mats is available to complement the factory-fitted option list. Volkswagen approved accessories purchased from and fitted by your authorised Volkswagen retailer at the point of vehicle sale will also benefit from the three-year vehicle warranty.

Extended Warranty

If you order the Volkswagen Extended Warranty as an option when buying your new Passat then you get the 100% Volkswagen Warranty and you can continue to enjoy comprehensive Volkswagen protection against many unforeseeable repair costs. Designed to your needs, you can purchase an extra one or two year's warranty up to a maximum of five years or 90,000 miles.

Service Intervals

Volkswagen is pleased to offer you a choice on how your Volkswagen is serviced. The appropriate selection is entirely dependent on how the car is likely to be driven and its general use. To help you identify which type of service would be most suitable, please refer to the following guide.

The Fixed Service is recommended for vehicles that will cover less than 10,000 miles in 12 months and if the vehicle is likely to be used in the following way:

- Predominantly urban driving, short journeys with frequent cold starts.
- Activities regularly producing high engine loading, e.g. frequent hill climbs, driving with vehicle fully loaded and towing.
- Uneconomical driving style using high rpms with heavy acceleration and heavy braking.

The service intervals for the Fixed Service are as follows:

- Oil change service – After 1 year or 10,000 miles (15,000km), whichever is soonest.
- Inspection service² – First after 2 years or 20,000 miles (30,000km), then every one year or 20,000 miles (30,000km), whichever is soonest.

The Flexible Service is recommended for vehicles with daily mileage of more than 25 miles where the vehicle is driven regularly mainly on longer distance journeys. The vehicle is driven mainly at a constant speed with minimum vehicle and engine loading, minimal towing and driven in an economical manner. With the Flexible Service the vehicle can cover anywhere between 10,000³ and a maximum of 20,000³ miles or 24 months (whichever is soonest) between oil changes.

The service intervals for the Flexible Service are as follows:

- Oil change service – According to flexible service interval display (after 2 years at the latest).
- Inspection service² – First after 2 years or 20,000 miles (30,000km), then every one year or 20,000 miles (30,000km), whichever is soonest.

The up! model is only available with the Fixed Service schedule. Please consult your authorised Volkswagen retailer or repairer for advice and full details.

Please note: If you purchase a Volkswagen Fixed Price Service Plan your vehicle will follow the Fixed Service schedule.

Volkswagen Insurance⁴

We want you to start enjoying your new car from day one and thanks to Volkswagen Insurance complimentary seven day cover, you can. Call free on 0800 316 7892 (lines are open Monday to Friday 8am – 9pm and Saturday 9am – 5pm), provide a few details and a cover note will be sent to your retailer. They will then tax your car and you can drive it away.

Volkswagen Ensurance⁵

Get three years' Volkswagen Ensurance cover for free.

Another great benefit of being a Volkswagen driver. If your Volkswagen was damaged in an accident, wouldn't you want it fixed by a Volkswagen trained technician using only genuine Volkswagen parts? Ensurance is Volkswagen's accident and repair cover which does exactly that. It works alongside your main comprehensive motor insurance policy no matter who you are insured with, to make sure you get the quality repair and service you would want. If you're involved in an accident or your car is stolen, just one call to us and we'll look after your claim from start to finish ensuring your Volkswagen is restored to the highest standard.

Activate your cover and benefit from:

- A guarantee that your Volkswagen will be repaired in a Volkswagen Insurance approved repairer, by Volkswagen trained technicians, using only genuine Volkswagen parts and paints.
- A dedicated Claims Manager will manage your claim from start to finish, liaising with your insurer and the repairer so you don't have to.
- Help to recover any uninsured losses using our Legal Expenses Cover.
- Online claims tracking so you can keep up to date with the status of any claim.

Volkswagen Ensurance is free to all Volkswagen customers for three years and it only takes a minute to get cover. To find out more and to activate your cover, visit volkswagen-ensurance.co.uk

Volkswagen Finance⁶

Volkswagen Finance specialises in providing funding solutions for Volkswagen drivers. Whether your Volkswagen is for private or business use, you can choose from a range of funding options.

- Solutions – a personal contract plan
- Hire purchase
- Lease purchase
- Finance lease
- Contract hire

With all Volkswagen Finance products you can choose a fixed-cost maintenance plan to help you budget for your servicing and maintenance costs. No matter what finance product you choose, your local Volkswagen retailer will be able to provide you with a personalised quote that could meet your budget and vehicle needs.

CO₂ Emissions

Increased weight of a vehicle, including higher trim levels and the addition of options will have a detrimental influence on the level of fuel consumption and CO₂ emissions produced.

The CO₂ and fuel consumption figures are obtained from tests on a representative vehicle of the type, conducted and approved in accordance with Council Directive 80/1268/EEC as amended by Directive 1999/100/EC (or later) on the approximation of the laws of the member states relating to the carbon dioxide emissions and the fuel consumption of motor vehicles.

Volkswagen Roadside Assistance

Every new car is registered for Volkswagen Roadside Assistance for one year except the Touareg and Phaeton which are registered for three years. This provides vehicle roadside and home recovery in the unlikely event of a breakdown in the UK and Europe (subject to conditions). Volkswagen Roadside Assistance can also be purchased for subsequent years. For full details, please contact your authorised Volkswagen retailer.

Tax Free Sales

For full details, please contact your authorised Volkswagen retailer.

Please note:

Some illustrations in this brochure do not necessarily reflect UK specifications and may not be available. In particular, controls and some items of equipment are positioned differently for the UK.

The specifications contained in this brochure are for information purposes only and are subject to change.

If you require any specific feature, you must consult your authorised Volkswagen retailer who is regularly updated with any change in specification. Please check model availability and full specification details with your authorised Volkswagen retailer prior to ordering.

Note: we would like to advise you that telephone calls to Volkswagen Customer Care may be monitored and recorded as part of our training and quality assurance processes. All our monitoring and recording processes meet Ofcom regulations.

¹ All warranty work must be completed by an authorised Volkswagen retailer or repairer.

² The inspection service first at 3 years (or 40,000 miles) and then every second year (or 40,000 miles) has additional workscope.

³ The quoted mileage is based on a conversion from kilometres and is therefore unlikely to exceed circa 18,000 miles between oil changes.

⁴ Volkswagen Insurance is a trading name of Volkswagen Insurance Service (Great Britain) Limited, an appointed representative of Volkswagen Financial Services (UK) Limited, Brunswick Court, Yeomans Drive, Blakelands, Milton Keynes MK14 5LR. Registered in England number 2835230. Volkswagen Insurance is sold, underwritten and administered by Allianz Insurance plc registered in England number 84638. Registered office 57 Ladymead, Guildford, Surrey GU1 1DB. Volkswagen Financial Services (UK) Limited and Allianz Insurance plc are authorised and regulated by the Financial Services Authority. Volkswagen Financial Services (UK) Limited and Allianz Insurance plc are not part of the same corporate group.

⁵ Ensurance from Volkswagen Insurance is sold and administered by Lawshield UK Limited, registered in England number: 3360532 (registered office: Lawshield House, 850 Ibis Court, Lakeside Drive, Centre Park, Warrington, Cheshire WA1 1RL) and underwritten by UK General Insurance Limited on behalf of Ageas Insurance Limited, registered in England number: 354568 (registered office: Ageas House, Tollgate, Eastleigh, Hampshire SO53 3YA).

⁶ Finance is available to 18s and over, subject to status. Terms and conditions apply. Volkswagen Finance.

The new Passat and Passat Estate

Volkswagen Information Service. Telephone: 0800 333 666

Internet: www.volkswagen.co.uk

© Volkswagen Group United Kingdom Limited 2014.

Issue: 1 December 2014. Printed in UK.

PVVW925PASNEW



facebook.com/VolkswagenUK



[@UKVolkswagen](https://twitter.com/UKVolkswagen)



youtube.com/UKVolkswagen