



> View offers



Book a > test drive

> AMG S 63 test drive

> AMG S 65 test drive



> Find a Retailer



> View the Range Guide

# S-Class Coupé



Effective from 1 September 2015.

Mercedes-Benz



# Contents

Model prices	11	AMG Exterior Carbon Fibre package	34	Technical data	50
Finance offers	12	AMG Night package	35	Road Fund Licence	54
Model lines	16	Premium package	36	Services and insurance	55
Mercedes-AMG driver training	22	Pricing summary for Premium package	37	Mercedes me	56
Standard equipment	24	Optional equipment	38	Mercedes-Benz Finance	58
Wheels	31	Genuine Accessories	44		
Driving Assistance package	33	Colours and materials	46		



> View offers



Book a > test drive

> AMG S 63 test drive  
> AMG S 65 test drive



> Find a Retailer



> View the Range Guide

## The hard facts to melt your heart

At Mercedes-Benz we appreciate the importance of detail. Over the following pages you'll find model prices and a breakdown of standard and optional equipment, as well as details of the comprehensive services and benefits that are available to every Mercedes-Benz driver.

See Mercedes-Benz in a new light. Now is the time to get yourself behind the wheel of an S-Class. Choose from a number of attractive finance offers. Please see pages 12–15 for further details, or visit [www.mercedes-benz.co.uk/offers](http://www.mercedes-benz.co.uk/offers)

Of course, some things have to be experienced to be truly appreciated, such as the qualities that set a Mercedes-Benz apart. Which is why we'd like to invite you for a test drive at your local Mercedes-Benz Retailer. Alternatively, you can make arrangements by visiting [www.mercedes-benz.co.uk/testdrive](http://www.mercedes-benz.co.uk/testdrive)

For more information visit [www.mercedes-benz.co.uk](http://www.mercedes-benz.co.uk) or call 0333 222 0500.



> View offers



Book a > test drive

> AMG S 63 test drive

> AMG S 65 test drive



> Find a Retailer



> View the Range Guide

4



Model features optional equipment at an additional cost.



> View offers



Book a > test drive

> AMG S 63 test drive

> AMG S 65 test drive



> Find a Retailer



> View the Range Guide





> View offers



Book a > test drive

- > AMG S 63 test drive
- > AMG S 65 test drive



> Find a Retailer



> View the Range Guide

6



Model features optional equipment at an additional cost.



> View offers



Book a > test drive

> AMG S 63 test drive

> AMG S 65 test drive



> Find a Retailer



> View the Range Guide



Model features optional equipment at an additional cost.



> View offers



Book a > test drive

- > AMG S 63 test drive
- > AMG S 65 test drive



> Find a Retailer



> View the Range Guide

8



Model features optional equipment at an additional cost.





> View offers



Book a > test drive

> AMG S 63 test drive  
> AMG S 65 test drive



> Find a Retailer



> View the Range Guide





> View offers



Book a > test drive

- > AMG S 63 test drive
- > AMG S 65 test drive



> Find a Retailer



> View the Range Guide



# Model prices

Engine	Model line	Transmission	CO <sub>2</sub>	Basic RRP excl. VAT (£)	Total RRP incl. VAT (£)	Road Fund Licence (£) <sup>1</sup>	Rec. OTR price (£) <sup>2</sup>	P11D value (£)	BiK tax rate 2015/16 (%)
<b>S 500</b> Petrol - 4,663 cc, 8-cylinder, 455 hp/335 kW	AMG Line	9G-TRONIC 9-speed automatic	197	79,195.83	95,035.00	490.00	96,195.00	95,650.00	34
<b>Mercedes-AMG</b>									
<b>Mercedes-AMG S 63</b> Petrol - 5,461 cc, 8-cylinder, 585 hp/430 kW	-	AMG SPEEDSHIFT MCT 7-speed automatic	237	103,387.50	124,065.00	870.00	125,605.00	124,680.00	37
<b>Mercedes-AMG S 65</b> Petrol - 5,980 cc, 12-cylinder, 630 hp/463 kW	-	AMG SPEEDSHIFT PLUS 7G-TRONIC 7-speed automatic	279	151,087.50	181,305.00	1,100.00	183,075.00	181,920.00	37

<sup>1</sup>A different first year rate of Vehicle Excise Duty (Road Fund Licence) applies for new cars. Please refer to page 54 for the relevant rate for the second and subsequent years

<sup>2</sup>Recommended on-the-road price: these prices reflect the Road Fund Licence applicable to the standard model plus £670.00 additional costs necessary to put your car on the road.

Included are a standard UK delivery charge (£540.00 incl. VAT), new vehicle registration fee (£55.00), number plates (£25.00 incl. VAT) and fuel (£50.00 incl. VAT). VAT is calculated at the standard rate of 20%

# Mercedes-Benz Finance

Even the finance offer is beautifully put together

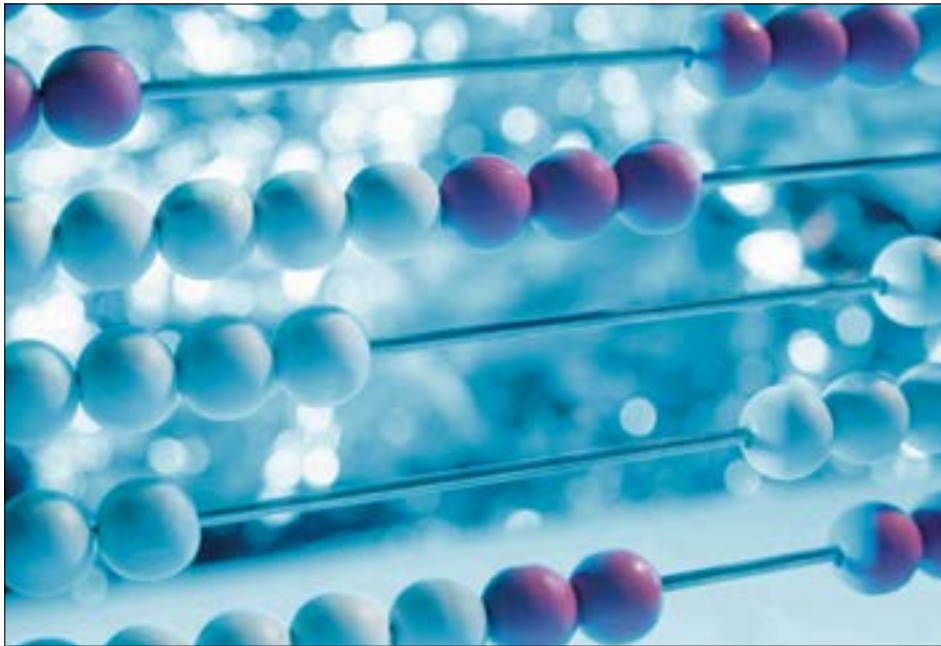

## S 500 AMG Line Coupé with automatic transmission and metallic paint (representative example)

36 monthly payments of <sup>1</sup>	£1,199.00
On-the-road price	£96,195.00
Customer deposit	£14,450.09
Retailer deposit contribution	£5,351.05
Duration of agreement	36 months
Optional purchase payment <sup>2</sup>	£44,600.00
Purchase activation fee <sup>2</sup>	£10.00
Amount of credit	£76,393.86
Total amount payable <sup>3</sup>	£107,575.14
Representative APR	6.4% APR
Fixed interest rate	6.17%



> View offers



Book a > test drive

> AMG S 63 test drive  
> AMG S 65 test drive



> Find a Retailer



> View the Range Guide

**Example offer –  
6.4% APR Representative**

	Automatic	Metallic	On-the-road price	Retailer deposit contribution	Customer deposit	36 monthly payments of <sup>1</sup>
S 500 AMG Line Coupé	●	●	£96,195.00	£5,351.05	£14,450.09	£1,199.00

● Standard equipment

### Mercedes-Benz Service Care

- Mercedes-Benz trained Technicians
- Maintained by Mercedes-Benz Retailers
- Meets requirements of Mercedes-Benz Agility finance agreement

### Mercedes-Benz Motor Insurance

- 24/7 UK accident recovery
- We use Mercedes-Benz GenuineParts
- To qualify for up to 10% discount online, go to [www.mercedes-benz.co.uk/motorinsurance](http://www.mercedes-benz.co.uk/motorinsurance)
- Alternatively, call Mercedes-Benz Motor Insurance now on **0345 600 2180<sup>4</sup>** for an annual quote

We may decline to quote in some circumstances. Mercedes-Benz Motor Insurance is underwritten by Aviva Insurance Limited

Whilst these offers are only available with Mercedes-Benz Finance, our Mercedes-Benz Retailers do arrange finance on behalf of other finance companies as well

Orders/credit approvals on selected S-Class Coupé models between 1 October and 31 December 2015, registered by 31 March 2016; excluding AMG S 63 and AMG S 65 models. Some combinations of features/options may not be available.

Please contact your local Mercedes-Benz Retailer for availability.

<sup>1</sup>Based on a Mercedes-Benz Agility agreement and 10,000 miles per annum. Vehicle condition, excess mileage and other charges may be payable. Quotations available on request for alternative contract lengths and mileages. Guarantees and indemnities may be required. Terms and Conditions apply. Credit provided subject to status by Mercedes-Benz Financial Services UK Ltd, MK15 8BA

<sup>2</sup>Payable if you exercise the option to purchase the car. Guaranteed future value if you choose to hand back the vehicle at the end of the contract

<sup>3</sup>Includes optional purchase payment, purchase activation fee and Retailer deposit contribution <sup>4</sup>Calls are charged at local rate and may be recorded

# Mercedes-Benz Finance

It comes with a specification list worth exploring

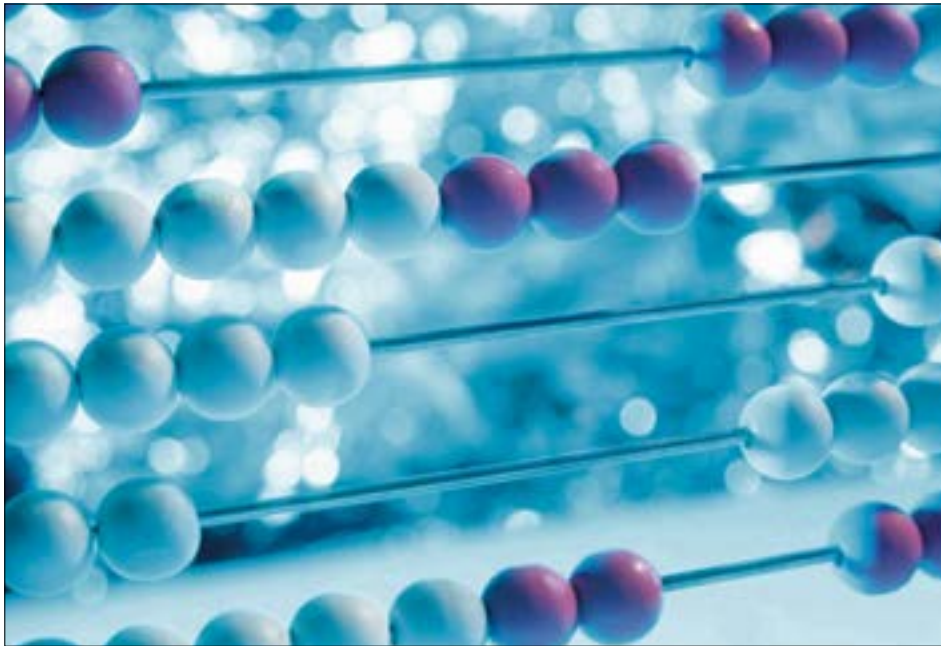

## Mercedes-AMG S 63 Coupé with automatic transmission and metallic paint (representative example)

36 monthly payments of <sup>1</sup>	£1,699.00
On-the-road price	£125,605.00
Customer deposit	£19,828.61
Duration of agreement	36 months
Optional purchase payment <sup>2</sup>	£58,425.00
Purchase activation fee <sup>2</sup>	£10.00
Amount of credit	£105,776.39
Total amount payable <sup>3</sup>	£139,427.61
Representative APR	6.4% APR
Fixed interest rate	6.17%

**Example offer –  
6.4% APR Representative**

	Automatic	Metallic	On-the-road price	Customer deposit	36 monthly payments of <sup>1</sup>
Mercedes-AMG S 63 Coupé	●	●	£125,605.00	£19,828.61	£1,699.00

● Standard equipment

Mercedes-Benz Service Care

- Mercedes-Benz trained Technicians
- Maintained by Mercedes-Benz Retailers
- Meets requirements of Mercedes-Benz Agility finance agreement

Mercedes-Benz Motor Insurance

- 24/7 UK accident recovery
- We use Mercedes-Benz GenuineParts
- To qualify for up to 10% discount online, go to [www.mercedes-benz.co.uk/motorinsurance](http://www.mercedes-benz.co.uk/motorinsurance)
- Alternatively, call Mercedes-Benz Motor Insurance now on **0345 600 2180<sup>4</sup>** for an annual quote

We may decline to quote in some circumstances. Mercedes-Benz Motor Insurance is underwritten by Aviva Insurance Limited

Whilst these offers are only available with Mercedes-Benz Finance, our Mercedes-Benz Retailers do arrange finance on behalf of other finance companies as well

Orders/credit approvals on Mercedes-AMG S-Class Coupé models between 1 October and 31 December 2015, registered by 31 March 2016; excluding non-AMG models. Some combinations of features/options may not be available. Please contact your local Mercedes-Benz Retailer for availability.

<sup>1</sup>Based on a Mercedes-Benz Agility agreement and 10,000 miles per annum. Vehicle condition, excess mileage and other charges may be payable. Quotations available on request for alternative contract lengths and mileages.

Guarantees and indemnities may be required. Terms and Conditions apply. Credit provided subject to status by Mercedes-Benz Financial Services UK Ltd, MK15 8BA

<sup>2</sup>Payable if you exercise the option to purchase the car. Guaranteed future value if you choose to hand back the vehicle at the end of the contract

<sup>3</sup>Includes optional purchase payment and purchase activation fee <sup>4</sup>Calls are charged at local rate and may be recorded



> View offers



Book a > test drive

- > AMG S 63 test drive
- > AMG S 65 test drive



> Find a Retailer



> View the Range Guide

16

## S500 AMG Line



Additional-cost options featured: designo diamond white bright paint finish (code 799)



The AMG Line design and equipment line includes chrome-coloured pins in the diamond radiator grille, dynamic AMG bodystyling with sporty AMG alloy wheels and perforated brake discs plus interior highlights in the

shape of a high-gloss black poplar wood trim. Further trim options such as metallised ash wood are available.





#### Exterior

Parking package – Active Parking Assist with PARKTRONIC and reversing camera
9G-TRONIC 9-speed automatic transmission with steering column gear selector, steering wheel gearshift paddles (Direct Select) and SPEEDTRONIC cruise control
19" AMG alloy wheels – 5-twin-spoke design
AIRMATIC air suspension with level adjustment and Adaptive Damping System
ECO start/stop function
Door mirrors – electrically operated, folding and heated
Headlamps – LED Intelligent Light System LED headlamps with variable light distribution for country roads and motorways, Active Light System, cornering light function, extended fog light function and Adaptive Highbeam Assist Plus
MAGIC VISION CONTROL – adaptive windscreen wiper system Allows the driver the best possible visibility even during the wiping process. Washer fluid is sprayed directly in front of the wiper blades and wiped away without delay. A heating system effectively lowers the risk of icing up
Panoramic roof with electric sun blind

#### Interior

Front Seat Memory package Additional four-way electric lumbar support for front passenger seat Front seats, front head restraints, steering column and exterior door mirrors – electrically adjustable with memory
Ambient lighting – choice of 7 colour settings
AMG floor mats with 'AMG' lettering
COMAND Online system with Media Interface
Door sill panels in brushed stainless steel with 'AMG' lettering
Near Field Communication for convenient, wireless mobile phone connection

#### Trim and Upholstery

Black poplar wood <sup>1</sup>	Brown burr walnut wood <sup>1</sup>
	
Leather – black	Leather – porcelain/espresso brown
	

<sup>1</sup>Choice of either black poplar or brown burr walnut wood trim Please refer to page 47 for the full range of trim and upholstery choices



> View offers



Book a > test drive

- > AMG S 63 test drive
- > AMG S 65 test drive



> Find a Retailer



> View the Range Guide

18

## Mercedes-AMG S63



Equipped with one of the most agile V8 engines, taking you from 0–62 mph in 4.2 seconds, the Mercedes-AMG S 63 is full of superlatives. You'll recognise the Mercedes-AMG S 63 by its very own AMG bodystyling, comprising matt silver front apron framing the striking headlamps with LED Intelligent Light System, as well as matt silver side sill panels and rear apron. 19" AMG alloy wheels are also key exterior features, along with the AMG sports exhaust system with chrome-plated twin tailpipes, which comes with two selectable

#### Exterior

19" AMG alloy wheels – 10-spoke design

AMG bodystyling

Comprising Mercedes-AMG S 63-specific front apron featuring front splitter in matt silver, with matt silver rear apron and side sill panels

AMG sports exhaust system with chrome-plated twin tailpipes, two modes (selectable sound)

AMG sports suspension based on MAGIC BODY CONTROL

Combining outstanding driving dynamics and precision with a high level of comfort

Panoramic roof with electric sun blind

'V8 BITURBO' lettering on front wings

sound modes. The interior marks a celebration of the finest wood and leather, combined with exquisite comfort: KEYLESS-GO Comfort package, AMG sports seats, heated rear seats, and automatic climate control with two zones and three modes are all standard. Choose the right mood with ambient lighting, or enjoy the open air look with the panoramic roof. For the perfect soundtrack, and to stay connected with the outside world, there is the COMAND Online system with Media Interface.

#### Interior

KEYLESS-GO Comfort package

KEYLESS-GO, remote boot closing and hands-free access

AMG 3-spoke multi-function sports steering wheel in nappa leather

AMG sports pedals in brushed stainless steel with rubber studs

AMG sports seats with AMG V8-specific seat layout, optimised lateral support and AMG badge in backrests

Burmester® surround sound system

#### Trim and Upholstery

Black poplar wood<sup>1</sup>

Brown burr walnut wood<sup>1</sup>

Nappa leather – black

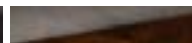

Nappa leather – crystal grey/black

Nappa leather – porcelain/espresso brown

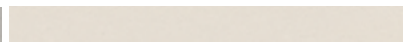

<sup>1</sup>Choice of either black poplar or brown burr walnut wood trim Please refer to page 47 for the full range of trim and upholstery choices



> View offers



Book a > test drive

- > AMG S 63 test drive
- > AMG S 65 test drive



> Find a Retailer



> View the Range Guide

20

## Mercedes-AMG S65



Please note that the AMG high-performance ceramic composite braking system shown above is an additional-cost option

The Mercedes-AMG S 65 with its almighty V12 engine will take you from 0–62 mph in 4.1 seconds. Beyond its striking coupé lines, the Mercedes-AMG S 65 offers the LED Intelligent Light System featuring 47 Swarovski crystals for a truly visual highlight; and Mercedes-AMG S 65-specific bodystyling all round. For gravitas, there are 20" AMG multi-spoke design alloy wheels and AMG sports exhaust system with polished chrome twin tailpipes. Inside,

expect nothing but the best: designo Exclusive nappa leather, Exclusive Nappa Leather package and illuminated AMG stainless steel door sill panels. The AMG sports seats feature a unique diamond-patterned V12 design, while the roof lining is also clad in nappa leather. As you'd expect, there are AMG brushed stainless steel sports pedals, and the Burmester® high-end 3D surround sound system provides the ultimate audio experience.

**Exterior**

20" AMG alloy wheels – multi-spoke design

AMG bodystyling

Comprising Mercedes-AMG S 65-specific front apron featuring front splitter in polished chrome, with polished chrome rear apron and side sill panels

AMG sports exhaust system with polished chrome twin tailpipes

Headlamps – LED Intelligent Light System with Swarovski crystals

LED headlamps with variable light distribution for country roads and motorways, Active Light System, cornering light function, extended fog light function and Adaptive Highbeam Assist with the addition of 47 Swarovski crystals providing striking visual highlights and emphasising the unique nature of vehicle

'V12 BITURBO' lettering on front wings

**Interior**

Exclusive Nappa Leather package





Including Mercedes-AMG S 65-specific features: AMG stainless steel door sill panels illuminated in white, chromed door pins, door centre panels in diamond-pattern design, leather-clad roof grab handles, leather-lined dashboard and nappa leather roof lining

AMG performance 3-spoke multi-function steering wheel in black nappa leather/DINAMICA microfibre – heated

AMG sports seats with AMG V12-specific seat layout, optimised lateral support and AMG badge in backrests

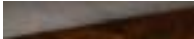
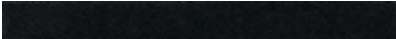
Burmester® high-end 3D surround sound system

**Trim and Upholstery**

Black poplar wood <sup>1</sup>	Brown burr walnut wood <sup>1</sup>	designo Exclusive nappa leather – black
		
designo Exclusive nappa leather – saddle brown/black		designo Exclusive nappa leather – crystal grey/black
		
designo Exclusive nappa leather – porcelain/espresso brown		
		

<sup>1</sup>Choice of either black poplar or brown burr walnut wood trim Please refer to page 47 for the full range of trim and upholstery choices



> View offers



Book a > test drive

> AMG S 63 test drive  
> AMG S 65 test drive



> Find a Retailer



> View the Range Guide

22

## Exclusive driver training for Mercedes-AMG owners

All Mercedes-AMG customers are invited to a complimentary AMG Driving Academy Training experience at Mercedes-Benz World.



With friendly one-to-one tuition from a professional Mercedes-AMG driver, your training will be personalised to you. You'll push Mercedes-AMG driving performance and your driving skills to the limits on our track and purpose-built low friction dynamic handling facilities.

Through high-speed and adrenaline-fuelled exercises you'll experience oversteer, understeer, slaloms and many more performance driving skills. Designed as part of your ownership experience, this will lay the foundations to master a high-performance vehicle, develop driving skills with maximum enjoyment and prepare you to take full command of your own Mercedes-AMG.

**TERMS AND CONDITIONS:** Only the first purchaser/registered keeper of a newly registered Mercedes-AMG is eligible for this complimentary AMG Driving Academy Training experience which is the AMG BASIC-Training as detailed above. The Training experience must be booked and taken within six months of delivery of your Mercedes-AMG; it cannot be exchanged and cannot be transferred for any other driving experience. The Training experience is available Monday to Friday only and is subject to availability. Mercedes-Benz UK Limited reserves the right to amend or withdraw this Training experience. Attendees must hold a full UK driving licence. Attendees will be required to sign the Mercedes-Benz World Driving Risk Acknowledgement prior to undertaking the Training experience. The Training experience is also subject to full Terms and Conditions, which are available on request.



> View offers



Book a > test drive

> AMG S 63 test drive  
> AMG S 65 test drive



> Find a Retailer



> View the Range Guide





> View offers



Book a > test drive

> AMG S 63 test drive  
> AMG S 65 test drive



> Find a Retailer



> View the Range Guide

24

## Standard equipment



Ambient lighting



Touchpad



Panoramic roof with electric sun blind



Memory package for driver and front passenger



MAGIC VISION CONTROL



THERMOTRONIC - luxury automatic climate control





Item	S 500 AMG Line	Mercedes-AMG S 63	Mercedes-AMG S 65
<b>Transmission and Suspension</b>			
9G-TRONIC 9-speed automatic transmission with steering column gear selector, steering wheel gearshift paddles (Direct Select) and SPEEDTRONIC cruise control	●	-	-
AMG SPEEDSHIFT MCT 7-speed sports transmission with ECO start/stop function and three transmission modes: 'C' (Controlled Efficiency), 'S' (Sport) and 'M' (Manual)	-	●	-
AMG SPEEDSHIFT PLUS MCT 7G-TRONIC automatic transmission with ECO start/stop function and three transmission modes: 'C' (Controlled Efficiency), 'S' (Sport) and 'M' (Manual)	-	-	●
AIRMATIC air suspension with level adjustment and Adaptive Damping System	●	-	-
AMG sports suspension based on MAGIC BODY CONTROL with curve tilting function Combining outstanding driving dynamics and precision with a high level of comfort	-	●	●
AMG speed-sensitive sports steering with variable steering ratio	-	●	●
Direct Steering	●	-	-
ECO start/stop function	●	●	●
Steering column – electrically adjustable with EASY-ENTRY function	●	●	●
Suspension settings switch	●	●	●

Item	S 500 AMG Line	Mercedes-AMG S 63	Mercedes-AMG S 65
<b>Exterior</b>			
AMG bodystyling Comprising Mercedes-AMG S 63-specific front apron featuring front splitter in matt silver, with matt silver rear apron and side sill panels	-	●	-
AMG bodystyling Comprising Mercedes-AMG S 65-specific front apron featuring front splitter in polished chrome, with polished chrome rear apron and side sill panels	-	-	●
AMG high-performance composite braking system	-	●	●
AMG radiator grille	-	●	●
AMG sports exhaust system with chrome-plated twin tailpipes, two modes (selectable sound)	-	●	-
AMG sports exhaust system with polished chrome twin tailpipes	-	-	●
Brake calipers – painted grey with 'AMG' lettering	-	●	●
Chrome-effect electronic key, master key with AMG emblem	-	●	●
Diamond radiator grille with chrome pins	●	-	-
Door mirrors – electrically operated, folding and heated	●	●	●



Item	S 500 AMG Line	Mercedes-AMG S 63	Mercedes-AMG S 65
<b>Exterior (continued)</b>			
Headlamps – LED Intelligent Light System LED headlamps with variable light distribution for country roads and motorways, Active Light System, cornering light function, extended fog light function and Adaptive Highbeam Assist Plus	●	●	–
Headlamps – LED Intelligent Light System with Swarovski crystals LED headlamps with variable light distribution for country roads and motorways, Active Light System, cornering light function, extended fog light function and Adaptive Highbeam Assist Plus with the addition of 47 Swarovski crystals providing striking visual highlights and emphasising the unique nature of vehicle	○	○	●
Heat-insulating, noise-insulating and infrared-reflecting laminated glass	●	●	●
LED indicators integrated in exterior mirrors	●	●	●
LED tail lamps	●	●	●
MAGIC VISION CONTROL – adaptive windscreen wiper system Allows the driver the best possible visibility even during the wiping process. Washer fluid is sprayed directly in front of the wiper blades and wiped away without delay. A heating system effectively lowers the risk of icing up	●	●	●
Panoramic roof with electric sun blind	●	●	●
'V8 BITURBO' lettering on front wings	–	●	–
'V12 BITURBO' lettering on front wings	–	–	●

Item	S 500 AMG Line	Mercedes-AMG S 63	Mercedes-AMG S 65
<b>Interior</b>			
AIR-BALANCE package – adjustable fragrancing with four different scents Fragrance generator with perfume flask in glove compartment Improved filter system between intake and distribution system Oxygen ioniser in side air duct	○	○	●
Front Seat Comfort package – dynamic multi-contour seats with massage function Provides optimum lateral support by means of individually-controlled air chambers which inflate depending on steering angle, lateral acceleration and vehicle speed. Massage function has six different programmes, with a choice of low- or high-intensity settings	○	●	●
Front Seat Memory package Additional four-way electric lumbar support for front passenger seat Front seats, front head restraints, steering column and exterior door mirrors – electrically adjustable with memory	●	●	●
KEYLESS-GO Comfort package – KEYLESS-GO, remote boot closing and hands-free access Vehicle can be conveniently unlocked, started and locked, simply by carrying an electronic key. In addition, the convenient hands-free access function allows hands-off, fully automatic opening and closing of the boot lid by performing a kicking motion under the rear bumper – particularly useful when laden with luggage	○	●	●
Warmth Comfort package Heatable armrests in centre console and doors Heated multi-function steering wheel (code 281 or 314)	○	○	●



> View offers



Book a > test drive

> AMG S 63 test drive  
> AMG S 65 test drive



> Find a Retailer



> View the Range Guide

Standard equipment

27

Item	S 500 AMG Line	Mercedes-AMG S 63	Mercedes-AMG S 65
<b>Interior (continued)</b>			
Ambient lighting – choice of 7 colour settings	●	●	●
AMG door sill panels in brushed stainless steel with ‘AMG’ lettering	●	●	–
AMG door sill panels in brushed stainless steel with ‘AMG’ lettering, illuminated	–	–	●
AMG emblem embossed in front centre armrest	–	●	●
AMG sports pedals in brushed stainless steel with rubber studs	–	●	●
AMG sports seats with AMG V8-specific seat layout, optimised lateral support and AMG badge in backrests	–	●	–
AMG sports seats with AMG V12-specific seat layout, optimised lateral support and AMG badge in backrests	–	–	●
Closing aid for doors When initially engaged, doors and boot lid are automatically closed by servo motors, ensuring smooth and virtually silent closing	●	●	●
Comfort-ventilated front seats – includes seat heating and cooling	○	○	●
Cup holders (2) – front	●	●	●
Doorhold system	●	●	●
Electric roller sun blind for rear window	○	○	●

Item	S 500 AMG Line	Mercedes-AMG S 63	Mercedes-AMG S 65
Floor mats – AMG floor mats with ‘AMG’ lettering	●	●	–
Floor mats – AMG Exclusive floor mats	–	○	●
Folding armrest for driver and front passenger	●	●	●
Full-length centre console in rear	●	●	●
Garage door opener – integrated in rear-view mirror For questions regarding compatibility please visit <a href="http://www.homelink.com">www.homelink.com</a>	○	○	●
Glasses stowage compartment	●	●	●
Glove compartment – lockable, air-conditioned and illuminated	●	●	●
Heated front seats	●	●	–
Heated rear seats	●	●	●
Heated rear window with timer control	●	●	–
Instrument cluster with 12.3-inch colour TFT display	●	●	●
Interior mirror and driver’s exterior mirror – automatically dimming	●	●	●
Luggage nets in luggage compartment	●	●	●
Map pockets on front seat backrests	●	●	●



Item	S 500 AMG Line	Mercedes-AMG S 63	Mercedes-AMG S 65
<b>Interior (continued)</b>			
Parcel nets in boot and front passenger footwell	●	●	●
Power windows with one-touch control and obstruction sensor	●	●	●
Reading lights - front and rear	●	●	●
Rear armrest	●	●	●
Remote boot lid release and closing	●	●	●
Seat Heating Plus for driver and front passenger seat	○	●	●
Service indicator ASSYST	●	●	●
Steering wheel - 3-spoke multi-function sports steering wheel	●	-	-
Steering wheel - AMG 3-spoke multi-function sports steering wheel in nappa leather	-	●	-
Steering wheel - AMG performance 3-spoke multi-function steering wheel in black nappa leather/DINAMICA microfibre - heated	-	-	●
Stowage compartment in centre console	●	●	●
Sun visors with illuminated vanity mirrors	●	●	●
THERMOTRONIC - luxury automatic climate control, two zone Three climate modes: Focused, Medium and Diffuse	●	●	●
Trip computer - in multi-function display, showing current fuel consumption	●	●	●

Item	S 500 AMG Line	Mercedes-AMG S 63	Mercedes-AMG S 65
<b>Paint, Trim and Upholstery</b>			
Upholstery - Exclusive Nappa Leather package AMG badges in front and rear seat backrests (Mercedes-AMG S 63 only) AMG stainless steel door sill panels, illuminated in white (Mercedes-AMG S 63 only) Armrests in nappa leather with contrast stitching Colour-contrasting fluting on beltline DINAMICA microfibre roof lining and electric roller sun blind for rear window Door centre panels in nappa leather with contrast stitching Map pockets on backrests of the driver and front passenger seats in nappa leather Nappa leather upper dashboard with contrast stitching and piping Parcel shelf in ARTICO leather <sup>1</sup> Seats in designo nappa leather featuring AMG-specific diamond design with contrast stitching, fluting and patterned perforations Stainless-steel boot sill Stainless steel door sill panels, illuminated in white (S 500 AMG Line)	○	○	●
Metallic paint	●	●	●
Roof lining - fabric	●	●	-
Roof lining - AMG roof lining in nappa leather	-	-	●
Trim - black poplar wood	●	●	●
Upholstery - leather	●	-	-
Upholstery - nappa leather	○	●	-
Upholstery - designo Exclusive nappa leather	○	○	●



## Standard equipment

29

Item	S 500 AMG Line	Mercedes-AMG S 63	Mercedes-AMG S 65
<b>Security and Safety</b>			
Driving Assistance package Please see page 33 for complete description	○	●	●
Parking package – Active Parking Assist with PARKTRONIC and reversing camera	●	–	–
Parking package – Active Parking Assist with PARKTRONIC PARKTRONIC monitors front and rear while vehicle is being manoeuvred and warns the driver if risk of collision is detected. Active Parking Assist helps find appropriate parking slots and can also automatically manoeuvre the car in and out of perpendicular and parallel parking spaces	–	●	●
360° camera	○	●	●
Alarm system with immobiliser and interior protection (MBSS3)	●	●	●
ADAPTIVE BRAKE system Including HOLD function, Hill-Start Assist, brake priming and dry braking in wet conditions	●	●	●
ADAPTIVE BRAKE lights	●	●	●
Airbags – driver and front passenger	●	●	●
Airbags – front and rear sidebags	●	●	●
Airbags – windowbags	●	●	●
Anti-lock braking system (ABS) with Brake Assist (BAS)	●	●	●
ATTENTION ASSIST Monitors steering and can help alert to long journey fatigue. Continuously analyses driver behaviour and steering movements. If patterns are recognised which characterise drowsiness, the driver is prompted to take a break, and an audible warning is sounded. At the same time COMAND Online offers to locate a rest stop	●	●	●

Item	S 500 AMG Line	Mercedes-AMG S 63	Mercedes-AMG S 65
Automatic front passenger airbag deactivation	●	●	●
Belt feeder	●	●	●
COLLISION PREVENTION ASSIST PLUS The driver is given a visual warning if the distance from a vehicle in front is inadequate. On detecting the danger of a collision there is an acoustic warning, driver braking can be assisted and, if the driver fails to react, the speed can be reduced autonomously. Autonomous partial braking only occurs if the driver fails to react and is travelling at a speed range between 4–65 mph speeds for moving objects and 4–31 mph for stationary objects	●	–	–
Crosswind Assist Detects sudden, strong gusts of wind and helps the driver stay in lane by means of targeted braking	●	●	●
Electric parking brake	●	●	●
Electronic Stability Programme (ESP®) with Acceleration Skid Control (ASR)	●	●	●
ESP® Curve Dynamic Assist Especially when accelerating on bends, ESP® can ensure improved handling by detecting understeer and effecting a remedy through braking intervention	●	●	●
Headlamp Assist – automatic headlamp activation	●	●	●
ISOFIX child seat fixing points in rear (two outer seats)	●	●	●
Night View Assist Plus Aids recognition of pedestrians or larger animals at night: they are clearly shown on the multi-function display	○	○	●
Rear head restraints	●	●	●



Item	S 500 AMG Line	Mercedes-AMG S 63	Mercedes-AMG S 65
<b>Security and Safety (continued)</b>			
Seat belts, rear – three point (2)	●	●	●
Speed Limit Assist with wrong-way warning function and display of speed limit in instrument cluster	●	●	●
Tirefit tyre-sealant kit	●	●	●
Traffic Sign Assist Speed Limit Assist with wrong-way warning function and display of speed limit in instrument cluster	●	●	●
Tyre pressure monitoring system	●	●	●
<b>Communications and In-Car Entertainment</b>			
Burmester® high-end 3D surround sound system 24 speakers and 24-channel amplifier with total output of 1,520 W	○	○	●
Burmester® surround sound system 13 speakers and 9-channel DSP amplifier with total output of 590 W	○	●	–
COMAND Online system with Media Interface Includes radio, single CD/DVD, Bluetooth® interface with high-definition call quality for hands-free telephony, 12.3-inch colour display, hard disk drive (HDD) navigation with 3D map display, Live Traffic Information and European map data updates free of charge for the first three years, Speed Limit Assist and LINGUATRONIC voice control. Integrated WLAN hotspot for onboard access of WLAN-enabled devices. Also includes SD memory card slot, 10 GB music register and MP3 compatibility. Media Interface allows connection and control of portable media devices (e.g. MP3 player, USB storage media)	●	●	●

● Standard ○ Optional – Not available

Item	S 500 AMG Line	Mercedes-AMG S 63	Mercedes-AMG S 65
DAB digital radio tuner	●	●	●
DVD player	●	●	–
DVD player with 6-disc changer	○	○	●
Head-up display – key driver information at a glance A virtual image (approx. 21 × 7 cm) is projected into the driver's field of view, appearing to float above the bonnet approx. 2 m ahead	○	○	●
Mercedes connect me (standard services) Including emergency call system (eCall), accident recovery, breakdown and maintenance management; Mercedes-Benz apps and in-car internet access for Facebook, internet radio, sending routes from Google Maps™ to the vehicle, news and weather reports; internet-enabled mobile phone required	●	●	●
Near Field Communication Enables a convenient, wireless connection of the mobile phone with the vehicle's telematics simply by holding the mobile phone near the NFC logo on the head unit	●	●	●
SPLITVIEW for COMAND Online system Two different images are displayed simultaneously by adjacent pixels. A filter in front of the display visually divides the mixed images so that, depending on seating position, the driver and front passenger see two different images in brilliant quality	○	○	●
Telephone pre-wiring with hands-free facility A separate cradle for your mobile phone needs to be ordered as an accessory from your Retailer	○	○	●
Touchpad	●	●	●
TV tuner – with digital reception capabilities	○	○	●



> View offers



Book a > test drive

> AMG S 63 test drive

> AMG S 65 test drive





> Find a Retailer



> View the Range Guide

# A revolution in style

Item	Notes						Basic RRP excl. VAT (£)	Total RRP incl. VAT (£)
Wheels								
19" AMG alloy wheels (4) – 5-twin-spoke design front: 245/45 tyres rear: 275/40 tyres			793	●	-	-	-	-
20" AMG alloy wheels (4) – multi-spoke design front: 245/40 tyres rear: 275/35 tyres	Only available as part of Premium package (code DP0). Please refer to pages 36–37 for more information		769	○	-	-	-	-
19" AMG alloy wheels (4) – 10-spoke design front: 255/45 tyres rear: 285/40 tyres			788	-	●	-	-	-

S 500 AMG Line  
 Mercedes-AMG S 63  
 Mercedes-AMG S 65



> View offers



Book a > test drive

> AMG S 63 test drive

> AMG S 65 test drive



> Find a Retailer



> View the Range Guide

Item	Notes		S 500 AMG Line	Mercedes-AMG S 63	Mercedes-AMG S 65	Basic RRP excl. VAT (£)	Total RRP incl. VAT (£)	
<b>Wheels (continued)</b>								
20" AMG alloy wheels (4) – multi-spoke design front: 255/40 tyres rear: 285/35 tyres			696	-	-	●	-	-
20" AMG alloy wheels (4) – 10-spoke design front: 255/40 tyres rear: 285/35 tyres			647	-	○	-	808.00	970.00
				-	-	○		no-cost option
20" AMG alloy wheels (4) – 10-spoke design, painted matt black front: 255/40 tyres rear: 285/35 tyres			648	-	○	-	1,450.00	1,740.00
				-	-	○		no-cost option

● Standard ○ Optional - Not available





> View offers



Book a > test drive

> AMG S 63 test drive  
> AMG S 65 test drive



> Find a Retailer



> View the Range Guide

# Driving Assistance package



Active Blind Spot Assist



Driving Assistance package

**Driving Assistance package** – designed and priced as a package, including items as listed below.

**Standard on Mercedes-AMG S 63 and Mercedes-AMG S 65**

**S 500 AMG Line**

**Total incl. VAT £3,180.00**

**With Premium package (code DP0)**

**£2,295.00**

**Driving Assistance package (code DP2)**

360° camera

Active Blind Spot Assist displays a red triangle in the exterior mirrors. When a road user is detected in the blind spot, the red triangle flashes and an audible warning sounds if the driver operates the indicators. Includes course-correcting braking intervention

Active Lane Keeping Assist detects signs of inadvertent drifting out of lane and warns the driver by vibrating the steering wheel and, if necessary, triggers one-sided braking intervention

BAS PLUS with Junction Assist. Brake Assist System develops additional brake pressure if a critical situation is detected and the driver applies the brakes

DISTRONIC PLUS with Steer Assist and Stop&Go Pilot helps the driver maintain the desired distance to the vehicle in front, and helps with lane guidance

PRE-SAFE® Brake prompts the driver to take action when the risk of a collision is detected and can initiate autonomous emergency braking at a speed of up to 30 mph

PRE-SAFE® PLUS initiates occupant protection measures if a rear-end collision is imminent, including activating the hazard lights, reversible belt tensioning, adjustment of passenger seat positions and closure of windows



> View offers



Book a > test drive

> AMG S 63 test drive  
> AMG S 65 test drive



> Find a Retailer



> View the Range Guide

## AMG Exterior Carbon Fibre package



AMG front apron in carbon fibre<sup>1</sup>



Exterior mirror housing in carbon fibre

This package adds breathtaking motor racing flair to your S-Class Coupé. The exterior features the A-wing of the AMG front apron in carbon fibre, while the exterior mirror housings, AMG side sill panels and AMG rear apron also feature carbon fibre.

**AMG Exterior Carbon Fibre package** – designed and priced as a package, including items as listed below.  
**Mercedes-AMG S 63 and Mercedes-AMG S 65 only** **Total incl. VAT £5,000.00**

**AMG Exterior Carbon Fibre package** (code 773)

---

A-wing of AMG front apron in carbon fibre

---

Exterior mirror housings, AMG side sill panels and AMG rear apron in carbon fibre

---

<sup>1</sup>Optional features shown: alloy wheels (code 648), ceramic brake calipers (code B07) and LED Intelligent Light System with Swarovski crystals (code 5U5)



> View offers



Book a > test drive

> AMG S 63 test drive

> AMG S 65 test drive



> Find a Retailer



> View the Range Guide

# AMG Night package



AMG sports exhaust system



Exterior mirror housing in high-gloss black<sup>2</sup>

More dramatic, more striking, more AMG: the AMG Night package includes an AMG front apron featuring an A-wing in high-gloss black. It also comes with an AMG sports exhaust system with two black chrome-finished twin tailpipe trim elements. The exterior mirror housings, AMG side sill panels and AMG rear apron are all finished in stylish high-gloss black.

**AMG Night package** – designed and priced as a package, including items as listed below.

**Mercedes-AMG S 63 and  
Mercedes-AMG S 65 only**

**Total incl. VAT £765.00**

**With AMG Exterior Carbon Fibre package (code 773)<sup>1</sup>**

**£410.00**

**AMG Night package** (code P60)

---

A-wing of AMG front apron in high-gloss black

---

AMG sports exhaust system with two black chrome-finished twin tailpipe trim elements

---

Exterior mirror housings, AMG side sill panels and AMG rear apron in high-gloss black

---

<sup>1</sup>When ordered with the AMG Exterior Carbon Fibre package, all of the components of the AMG Exterior Carbon Fibre package are added, plus the following components of the AMG Night package: two black twin tailpipe trim elements, A-wing trim in high-gloss black and front splitter in high-gloss black <sup>2</sup>Optional features shown: alloy wheels (code 647), red brake calipers (code U70) and LED Intelligent Light System with Swarovski crystals (code 5U5)



> View offers



Book a > test drive

> AMG S 63 test drive  
> AMG S 65 test drive



> Find a Retailer



> View the Range Guide

36

## Premium package



360° camera provides visual support when manoeuvring



AIR-BALANCE package



Burmester® surround sound system



Comfort-ventilated front seats



20" AMG alloy wheels in multi-spoke design



Front Seat Comfort package

If you want to increase your comfort and add the best in entertainment to the S 500 AMG Line, the Premium package does just that. Designed and priced as a package, including items listed below.

	DPO	S 500 AMG Line	Mercedes-AMG S 63	Mercedes-AMG S 65	Basic RRP excl. VAT (£)	Total RRP incl. VAT (£)
<b>Premium package</b> 20" alloy wheels – multi-spoke design 360° camera – monitors the entire area surrounding the vehicle, providing visual support when parking and manoeuvring AIR-BALANCE package – provides individual fragrancing of the interior with four different fragrances Burmester® surround sound system – 13 speakers and a 9-channel amplifier with total output of 590W (7×50W and 2×120W) Comfort-ventilated front seats – includes seat heating and cooling Front Seat Comfort package – active multi-contour seats with massage function Illuminated door sills – AMG door sill panels in brushed stainless steel with 'AMG' lettering KEYLESS-GO Comfort package – including hands-free access, automatic powered boot closing, keyless entry and keyless start		○	–	–	4,162.50	4,995.00

### Pricing summary for Premium package

Recommended OTR price (£)<sup>1</sup>

Model	Transmission	AMG Line	AMG Line Premium
S 500	9G-TRONIC 9-speed automatic	96,195.00	101,190.00

● Standard ○ Optional – Not available <sup>1</sup>Recommended on-the-road price: these prices reflect the Road Fund Licence applicable to the standard model plus £670.00 additional costs necessary to put your car on the road. Included are a standard UK delivery charge (£540.00 incl. VAT), new vehicle registration fee (£55.00), number plates (£25.00 incl. VAT) and fuel (£50.00 incl. VAT). VAT is calculated at the standard rate of 20%



> View offers



Book a > test drive

> AMG S 63 test drive  
> AMG S 65 test drive



> Find a Retailer



> View the Range Guide

# Optional equipment

Item	Notes				S 500 AMG Line	Mercedes-AMG S 63	Mercedes-AMG S 65	Basic RRP excl. VAT (£)	Total RRP incl. VAT (£)
<b>AMG Performance Studio</b>									
AMG Driver's package Includes an increase to your vehicle's electronically limited top speed (186 mph) and participation in one of the AMG BASIC-Training 'Power and Passion' events. The event is run by the AMG Driving Academy and held at a racetrack located in mainland Europe	For further information on this or any other AMG Driving Academy training, please speak to your Retailer, or visit <a href="http://www.mercedes-amg.com/driving-academy">www.mercedes-amg.com/driving-academy</a>	250	-	○	-		2,300.00	<b>2,760.00</b>	
			-	-	○		637.50	<b>765.00</b>	
AMG carbon fibre engine cover		B14	-	○	-		1,291.67	<b>1,550.00</b>	
AMG high-performance ceramic composite braking system With composite brake discs, 420×40 mm front and 360×32 mm rear, plus specially-painted yellow brake calipers with 'AMG Carbon Ceramic' lettering	Only in conjunction with AMG alloy wheels (code 647 or 648). Not in conjunction with red-painted brake calipers (code U70). Please check with your Retailer for availability	B07	-	○	○		5,908.33	<b>7,090.00</b>	
AMG performance 3-spoke multi-function steering wheel in nappa leather/ DINAMICA microfibre (heated)	Heating element only in conjunction with Warmth Comfort package (code P68)	281	-	○	●		350.00	<b>420.00</b>	
<b>Suspension and Exterior</b>									
AMG Exterior Carbon Fibre package A-wing of AMG front apron, exterior mirror housings, AMG side sill panels and AMG rear apron in carbon fibre		773	-	○	○		4,166.67	<b>5,000.00</b>	
AMG Night package A-wing of AMG front apron, exterior mirror housings, AMG side sill panels and AMG rear apron in high-gloss black. AMG sports exhaust system with two black chrome-finished twin tailpipe trim elements		P60	-	○	○		637.50	<b>765.00</b>	
	In conjunction with AMG Exterior Carbon Fibre package (code 773)						341.67	<b>410.00</b>	
Air inlet grilles and flics on front apron in high-gloss black instead of high-gloss chrome	Included with AMG Night package (code P60)	5U2	-	-	○		<b>no-cost option</b>		
Brake calipers – painted red, with 'AMG' lettering	Not in conjunction with AMG high-performance ceramic composite braking system (code B07)	U70	-	○	○		516.67	<b>620.00</b>	



> View offers



Book a > test drive

> AMG S 63 test drive  
> AMG S 65 test drive



> Find a Retailer



> View the Range Guide

Optional equipment

39

Item	Notes				Basic RRP excl. VAT (£)	Total RRP incl. VAT (£)	
		S 500 AMG Line	Mercedes-AMG S 63	Mercedes-AMG S 65			
<b>Suspension and Exterior (continued)</b>							
Headlamps - LED Intelligent Light System with Swarovski crystals LED headlamps with variable light distribution for country roads and motorways, Active Light System, cornering light function, extended fog light function and Adaptive Highbeam Assist Plus, with the addition of 47 Swarovski crystals providing striking visual highlights and emphasising the unique nature of the vehicle	Replaces LED Intelligent Light System. Only available in conjunction with Night View Assist Plus (code 610)	5U5	○	○	●	2,383.33	2,860.00
MAGIC BODY CONTROL		487	○	●	●	3,616.67	4,250.00
<b>Paint, Trim and Upholstery</b>							
Upholstery - Exclusive Nappa Leather package AMG badges in front and rear seat backrests (Mercedes-AMG S 63 only) AMG stainless steel door sill panels, illuminated in white (Mercedes-AMG S 63 only) Armrests in nappa leather with contrast stitching Colour-contrasting fluting on beltline DINAMICA microfibre roof lining and electric roller sun blind for rear window Door centre panels in nappa leather with contrast stitching Map pockets on backrests of the driver and front passenger seats in nappa leather Nappa leather upper dashboard with contrast stitching and piping Parcel shelf in ARTICO leather <sup>1</sup> Seats in designo nappa leather featuring diamond design with contrast stitching, fluting and patterned perforations Stainless-steel boot sill Stainless steel door sill panels, illuminated in white (S 500 AMG Line)	S 500 AMG Line: available in black/black (code 961), porcelain/espresso brown (code 965), bengal red/black (code 977), crystal grey/black (code 978), saddle brown/black (code 974), porcelain/deep sea blue (code 975). Only available in conjunction with Premium package (code DP0).  Mercedes-AMG: available in black/black (code 561), porcelain/espresso brown (code 565), bengal red/black (code 567), crystal grey/black (code 568), saddle brown/black (code 584), porcelain/deep sea blue (code 585). Only available in conjunction with comfort-ventilated front seats - includes seat heating and cooling (code 401).  All contrast stitching except that on the upper dashboard and beltlines is omitted if porcelain/espresso brown (code 965 or code 565) is ordered.	P34	○	-	●	5,195.83	6,235.00
			-	○			3,883.33



> View offers



Book a > test drive

> AMG S 63 test drive  
> AMG S 65 test drive



> Find a Retailer



> View the Range Guide

Item	Notes				Basic RRP excl. VAT (£)	Total RRP incl. VAT (£)
		S 500 AMG Line	Mercedes-AMG S 63	Mercedes-AMG S 65		
<b>Paint, Trim and Upholstery (continued)</b>						
designo diamond white bright		799	○	○	633.33	760.00
designo magno allanite grey	designo magno matt paint finishes require extra care. Please refer to the Owner's Manual for instructions	044	○	○	3,041.67	3,650.00
designo magno cashmere white		049	○	○	3,041.67	3,650.00
designo mocha black metallic		033	○	○	2,608.33	3,130.00
Trim – AMG carbon fibre/black piano lacquer	Only in conjunction with Exclusive Nappa Leather package (P34)	H10	○	○	3,316.67	3,980.00
Trim – brown burr walnut wood		731	○	○		no-cost option
Trim – designo black piano lacquer	Only in conjunction with Exclusive Nappa Leather package (P34)	H21	○	○	1,266.67	1,520.00
Trim – designo metallised ash wood	Only in conjunction with Exclusive Nappa Leather package (P34)	H06	○	○	587.50	705.00
Upholstery – nappa leather		1	○	●	1,441.67	1,730.00





> View offers



Book a > test drive

> AMG S 63 test drive  
> AMG S 65 test drive



> Find a Retailer



> View the Range Guide

Optional equipment

Item	Notes					Basic RRP excl. VAT (£)	Total RRP incl. VAT (£)
			S 500 AMG Line	Mercedes-AMG S 63	Mercedes-AMG S 65		
AIR-BALANCE package – adjustable fragrancing with four different scents Fragrance generator with perfume flask in glove compartment Improved filter system between intake and distribution system Oxygen ioniser in side air duct		P21	-	○	●	316.67	380.00
	In conjunction with Premium package (code DP0) for S 500 AMG Line		○	-	-		0.00
Warmth Comfort package Heatable armrests in centre console and doors Heated multi-function steering wheel (code 281 or 314)		P68	-	○	●	366.67	440.00
	With multi-function 3-spoke sports steering wheel in wood/leather finish (code 314)		○	○		895.83	1,075.00
	With AMG performance 3-spoke multi-function steering wheel in nappa leather/DINAMICA microfibre, heated (code 281)		-	○		716.67	860.00
AMG Exclusive floor mats		U24	-	○	●	216.67	260.00
Ashtray and cigarette lighter	Replaces stowage compartment and 12V socket	301	○	○	○	41.67	50.00
Comfort-ventilated front seats – includes seat heating and cooling		401	-	○	●	550.00	660.00
	In conjunction with Premium package (code DP0) for S 500 AMG Line		○	-	-		0.00
Electric roller sun blind for rear window		540	○	○	●	375.00	450.00
Door sill panels with 'Mercedes-Benz lettering', illuminated		U25	-	○	●	133.33	160.00
	In conjunction with Premium package (code DP0) for S 500 AMG Line		○	-	-		0.00
Garage door opener – integrated in rear-view mirror For questions regarding compatibility please visit <a href="http://www.homelink.com">www.homelink.com</a>		231	○	○	●	191.67	230.00

[View offers](#)[Book a test drive](#)[AMG S 63 test drive](#)  
[AMG S 65 test drive](#)[Find a Retailer](#)[View the Range Guide](#)

Item	Notes				Basic RRP excl. VAT (£)	Total RRP incl. VAT (£)
		S 500 AMG Line	Mercedes-AMG S 63	Mercedes-AMG S 65		
<b>Comfort (continued)</b>						
Heated windscreen	Only in conjunction with head-up display (code 463). Not in conjunction with TV tuner (code 865)	597	○	○	366.67	440.00
Multi-function 3-spoke sports steering wheel in wood/leather finish		314	○	○	529.17	635.00
Panoramic roof with MAGIC SKY CONTROL – switchable transparency The large panoramic roof changes from dark to transparent or vice versa within a few seconds. In its tinted state, it substantially reduces heating-up of the vehicle interior	Please check with your Retailer for availability	398	○	○	3,358.33	4,030.00
Refrigerated compartment in rear Elegantly integrated into the rear armrest and with a capacity of approx. 8.5 litres. Temperature can be set between approx. 4–15° C using two control switches	Reduces luggage capacity by 30 litres	308	○	○	941.67	1,130.00
Ski bag with through-loading facility		282	○	○	266.67	320.00
<b>Security and Safety</b>						
360° camera	In conjunction with Premium package (code DP0) for S 500 AMG Line	501	○	●		0.00
Night View Assist Plus Aids recognition of pedestrians or larger animals at night: they are clearly shown on the multi-function display		610	○	○	1,733.33	2,080.00



> View offers



Book a > test drive

> AMG S 63 test drive  
> AMG S 65 test drive



> Find a Retailer



> View the Range Guide

Optional equipment

Item	Notes				Basic RRP excl. VAT (£)	Total RRP incl. VAT (£)	
		S 500 AMG Line	Mercedes-AMG S 63	Mercedes-AMG S 65			
<b>Communications and In-Car Entertainment</b>							
Burmester® high-end 3D surround sound system 24 speakers and 24-channel amplifier with total output of 1,520 W	Reduces luggage capacity by 30 litres. Not in conjunction with Burmester® surround sound system (code 810). Only in conjunction with electric roller sun blind for rear window (code 540). S 500 AMG Line with Premium package (code DP0)	811	○	○	●	4,416.67	5,300.00
	Without Premium package (code DP0)		○	-	-	5,358.33	6,430.00
Burmester® surround sound system 13 speakers and 9-channel DSP amplifier with total output of 590 W	In conjunction with Premium package (code DP0) for S 500 AMG Line	810	○	●	-	0.00	
DVD changer - 6-disc		814	○	○	●	216.67	260.00
Head-up display	A virtual image (approx. 21×7 cm) is projected into the driver's field of view, appearing to float above the bonnet approx. 2 m ahead	463	○	○	●	883.33	1,060.00
SPLITVIEW Two different images are displayed simultaneously by adjacent pixels. A filter in front of the display visually divides the mixed images so that, depending on seating position, the driver and front passenger see two different images in brilliant quality		867	○	○	●	683.33	820.00
Telephone pre-wiring with hands-free facility and 4G LTE-compatible external aerial	A separate cradle for your mobile phone needs to be ordered as an accessory from your Retailer	386	○	○	●	341.67	410.00
TV tuner - with digital reception capabilities	Not in conjunction with heated windscreen (code 597)	865	○	○	●	925.00	1,110.00
<b>Service Package</b>							
Service Care Service Care allows you to spread the cost of servicing your new car in the Mercedes-Benz Retailer network. Taking out a Service Care plan ensures your servicing needs are taken care of by fully trained Mercedes-Benz Technicians with the added benefit of a Mercedes-Benz service history	Price is based on a monthly rate. Example given is for two services taken over 24 months, three services over 36 months or four services over 48 months. Further payment options are available. New Service Care prices apply only to vehicles up to 12 months old prior to first service		○	-	-	34.16	41.00
			-	○	○	37.50	45.00



> View offers



Book a > test drive

> AMG S 63 test drive

> AMG S 65 test drive



> Find a Retailer



> View the Range Guide

44

## Genuine Accessories

We've developed a range of Accessories you can add to help personalise and enhance your S-Class Coupé. Your local Mercedes-Benz Retailer can advise on fitting costs of Accessories, where applicable. Further information on our selection of Genuine Accessories can be found on the Mercedes-Benz UK website.

01



**01 | Luggage net, floor of load compartment**  
Prevents lightweight objects from sliding around during your journey.

Basic RRP £48.33 (excl. VAT) **Total RRP £58.00 (incl. VAT)**

**02 | Classic velour mats**

Elegant, high-quality tufted velour mats, featuring metal badge with 'Mercedes-Benz' lettering. Available in various colours to match your interior. Set of four.

Basic RRP £104.17 (excl. VAT) **Total RRP £125.00 (incl. VAT)**

**03 | Exterior Car Care Kit**

The Mercedes-Benz Exterior Car Care Kit is a four-piece collection to keep the exterior of your car looking like it's come straight from the showroom. The bag contains car shampoo, wheel cleaner, sponge and polishing cloth.

Basic RRP £20.83 (excl. VAT) **Total RRP £25.00 (incl. VAT)**

#### 04 | Interior Car Care Kit

The Mercedes-Benz Interior Car Care Kit is a four-piece collection enabling you to maintain a spotless showroom finish inside your car. The bag contains cabin care spray, interior glass cleaner, interior glass sponge and car cloth.

Basic RRP £20.83 (excl. VAT) **Total RRP £25.00 (incl. VAT)**

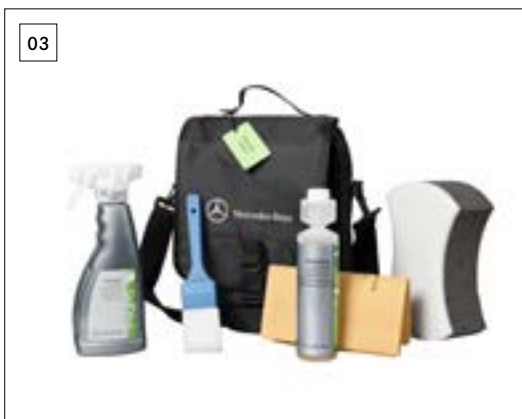

#### 05 | AMG Indoor Car Cover

Basic RRP £210.83 (excl. VAT) **Total RRP £253.00 (incl. VAT)**



#### 06 | Flacon perfume atomiser<sup>1</sup>

The interior of the vehicle can be fragranced individually to suit your tastes. There are four high-quality fragrances to choose from, designed to suit your personal preferences and mood: DOWNTOWN, NIGHTLIFE, FREESIDE and SPORTS.

Basic RRP £45.83 (excl. VAT) **Total RRP £55.00 (incl. VAT)**



<sup>1</sup>In conjunction with AIR-BALANCE package (code P21; optional on S 500 AMG Line and Mercedes-AMG S 63)



> View offers



Book a > test drive

> AMG S 63 test drive  
> AMG S 65 test drive



> Find a Retailer



> View the Range Guide

# Colours and materials

## Metallic paints

Standard



183 magnetite black



890 cavansite blue



989 emerald green



197 obsidian black



897 ruby black



992 selenite grey



775 iridium silver



988 diamond silver



998 anthracite blue

## designo paints

Additional-cost option



033 mocha black metallic



044 magno allanite grey<sup>1</sup>



049 magno cashmere white<sup>1</sup>



799 diamond white bright

<sup>1</sup>designo magno matt paint finishes require extra care. Please refer to the Owner's Manual for instructions

Please note that, owing to limitations of the printing process, paint colours may differ from those shown



> View offers



Book a > test drive

> AMG S 63 test drive  
> AMG S 65 test drive



> Find a Retailer



> View the Range Guide

**Leather**

Standard on S 500 AMG Line



201 black



205 porcelain/espresso brown

**Nappa leather**

Standard on Mercedes-AMG S 63;  
optional on S 500 AMG Line

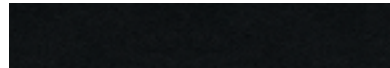

851 [801] black



855 [805] porcelain/espresso brown



858 [818] crystal grey/black

**designo Exclusive nappa leather**

Standard on Mercedes-AMG S 65<sup>1</sup>; optional on  
Mercedes-AMG S 63 and S 500 AMG Line



561 [961] black



565 [965] porcelain/espresso brown



567 [977] bengal red/black



568 [978] crystal grey/black



584 [974] saddle brown/black



585 [975] porcelain/deep sea blue

**Trim**



729 black poplar wood<sup>2</sup>

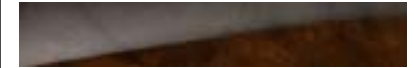

731 brown burr walnut wood<sup>3</sup>



H06 designo metallised ash wood<sup>4</sup>



H10 AMG carbon fibre/black piano lacquer<sup>4</sup>



H21 designo black piano lacquer<sup>4</sup>

<sup>1</sup>Included with Exclusive Nappa Leather package (code P34) <sup>2</sup>Standard <sup>3</sup>No-cost option <sup>4</sup>Additional-cost option Codes in square brackets refer to S 500 AMG Line order codes

[View offers](#)[Book a test drive](#)[AMG S 63 test drive](#)  
[AMG S 65 test drive](#)[Find a Retailer](#)[View the Range Guide](#)

# Trim and upholstery combinations

	Leather/nappa leather/designo Exclusive nappa leather		Nappa leather/designo Exclusive nappa leather	designo Exclusive nappa leather		
	black (201/851 [801]/561 [961])	porcelain/espresso brown (205/855 [805]/565 [965])	crystal grey/black (858 [818]/568 [978])	saddle brown/black (584 [974])	bengal red/black (567 [977])	porcelain/deep sea blue (585 [975])
<b>Dashboard</b>						
Steering wheel	black	porcelain	black	black	black	porcelain
Upper dashboard trim	black	espresso brown	black	black	black	deep sea blue
Centre dashboard trim	black	porcelain	crystal grey	saddle brown	bengal red	porcelain
Lower dashboard trim	black	porcelain	crystal grey	saddle brown	bengal red	porcelain
<b>Seats</b>						
Seat cushion centre section	black	porcelain	crystal grey	saddle brown	bengal red	porcelain
Side bolster trim	black	porcelain	crystal grey	saddle brown	bengal red	porcelain
Head restraint	black	porcelain	crystal grey	saddle brown	bengal red	porcelain
Contrast stitching	black	porcelain/espresso brown	crystal grey/black	saddle brown/black	bengal red/black	porcelain/deep sea blue
Seat belt	black	porcelain	crystal grey	black	black	porcelain
<b>Doors</b>						
Door trim at beltline	black	espresso brown	black	black	black	deep sea blue
Door centre panel	black	porcelain	crystal grey	saddle brown	bengal red	porcelain
Lower door trim	black	porcelain	black	black	black	deep sea blue
<b>Roof lining</b>	black	porcelain	crystal grey	black	black	porcelain
<b>Parcel shelf</b>	black	espresso brown	black	black	black	deep sea blue
<b>Floor covering</b>						
Front and rear	black	porcelain	black	black	black	deep sea blue
Boot	black	black	black	black	black	black





> View offers



Book a > test drive

> AMG S 63 test drive  
> AMG S 65 test drive



> Find a Retailer



> View the Range Guide

# Combination options

Leather/nappa leather/designo Exclusive nappa leather		Metallic paints									designo paints					
		Standard	183 magnetite black	197 obsidian black	775 iridium silver	890 cavansite blue	897 ruby black	988 diamond silver	989 emerald green	992 selenite grey	998 anthracite blue	Additional-cost option	033 mocha black metallic	044 magno allanite grey <sup>1</sup>	049 magno cashmere white <sup>1</sup>	799 diamond white bright
	black	●	●	●	●	●	●	●	●	●		●	●	●	●	
	porcelain/espresso brown	●	●	△	●	○	●	●	●	●		●	○	●	●	
	crystal grey/black	●	●	●	●	●	●	○	●	●		●	●	●	●	
	saddle brown/black	●	●	○	△	○	○	●	●	○		●	○	●	●	

● Recommended ○ Possible △ Not recommended <sup>1</sup>designo magno matt paint finishes require extra care. Please refer to the Owner's Manual for instructions  
Please note that, owing to limitations of the printing process, paint colours may differ from those shown

[View offers](#)[Book a test drive](#)[AMG S 63 test drive](#)  
[AMG S 65 test drive](#)[Find a Retailer](#)[View the Range Guide](#)

50

# Technical data

		Petrol engines		
Model		S 500	Mercedes-AMG S 63	Mercedes-AMG S 65
<b>Engine</b>				
Total displacement	cc	4,663	5,461	5,980
Arrangement/cylinders/valves		V/8/32	V/8/32	V/12/36
Power <sup>1</sup>	hp (kW) at rpm	455 (335)/5,250–5,500	585 (430)/5,500	630 (463)/4,800–5,400
Torque <sup>1</sup>	Nm at rpm	700/1,800–3,500	900/2,250–3,750	1,000/2,300–4,300
<b>Transmission</b>				
9G-TRONIC 9-speed automatic transmission		●		–
AMG SPEEDSHIFT MCT 7-speed automatic sports transmission		–	●	–
AMG SPEEDSHIFT PLUS 7G-TRONIC 7-speed automatic transmission		–	–	●
<b>Performance</b>				
Acceleration 0–62 mph	sec	4.6	4.2	4.1
Top speed	mph	155 <sup>2</sup>	155 <sup>2</sup>	155 <sup>2</sup>

● Standard ○ Optional – Not available

Model	Petrol engines		
	S 500	Mercedes-AMG S 63	Mercedes-AMG S 65

**Weights and capacities**

Kerb weight	kg	2,030	2,070	2,185
Perm. Gross Vehicle Weight	kg	2,585	2,535	2,585
Boot capacity	l	400	400	400
Fuel tank capacity/ of which reserve	l	80/8	80/12	80/12
Turning circle	m	11.6	11.6	11.6

**Fuel consumption<sup>3,4</sup>** mpg

Urban	24.4	20.2	16.5
Extra-urban <sup>5</sup>	42.8	36.2	32.8
Combined	33.2	28.0	23.7

Model	Petrol engines		
	S 500	Mercedes-AMG S 63	Mercedes-AMG S 65
<b>CO<sub>2</sub> emissions<sup>1</sup></b>	g/km		
Emissions standard	EU6	EU6	EU6
19" alloy wheels – code 788	–	237	–
19" alloy wheels – code 793	197	–	–
20" alloy wheels – code 647	–	237	279
20" alloy wheels – code 648	–	237	279
20" alloy wheels – code 696	–	–	279
20" alloy wheels – code 769	204	–	–
<b>Insurance</b>			
Group rating	50A	50A	50A
Insurance ratings may vary depending on model line and specification. Please refer to <a href="http://www.thatcham.org/abigrouprating/">http://www.thatcham.org/abigrouprating/</a> for further details			

<sup>1</sup>Figures according to Directive 80/1269/EEC in the currently applicable version <sup>2</sup>Electronically limited <sup>3</sup>All figures are based on a standard specification with the smallest tyre size

<sup>4</sup>The choice of wheels and transmission may affect CO<sub>2</sub> emissions and corresponding Road Fund Licence <sup>5</sup>EUUDC: extra-urban driving cycle. Testing procedures adhere to EU Directive 93/116



> View offers



Book a > test drive

> AMG S 63 test drive  
> AMG S 65 test drive



> Find a Retailer



> View the Range Guide

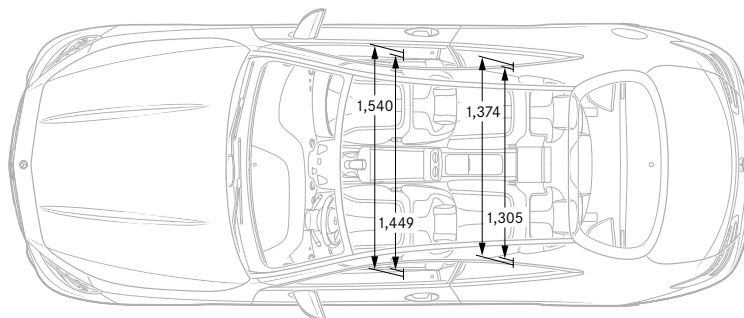
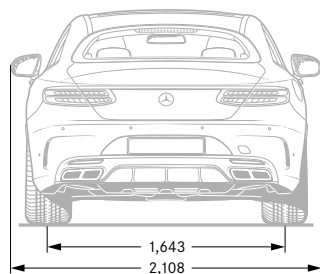
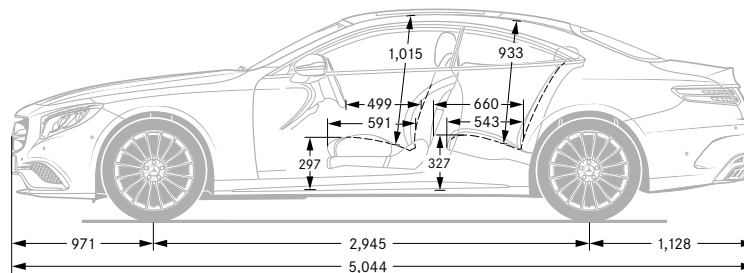
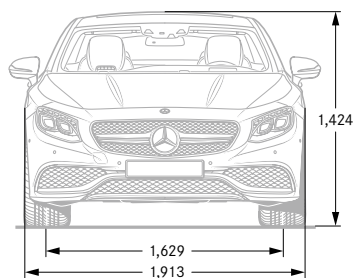

The figures on pages 50–53 are correct at time of going to print. Please refer to the government website for latest data – <http://carfueldata.direct.gov.uk/>  
All measurements in millimetres. The dimensions shown are mean values and apply to standard-specification, unladen vehicles



> View offers



Book a > test drive

> AMG S 63 test drive

> AMG S 65 test drive



> Find a Retailer



> View the Range Guide

# Road Fund Licence



All road vehicle registrations are subject to Vehicle Excise Duty (Road Fund Licence), which varies in accordance with the vehicle's CO<sub>2</sub> emissions. A first year rate of Vehicle Excise Duty applies to new cars on their first year of registration. For the second and subsequent years a standard rate for each taxation band will apply.<sup>1</sup> The table below shows the bands (A–M) created by the DVLA and the corresponding Road Fund Licence. CO<sub>2</sub> emissions are listed in the technical data on page 52, and the relevant Excise Duty is reflected in the on-the-road prices on page 11.

Band	CO <sub>2</sub> emissions	First year rate (£)	Standard rate (£)
A	up to 100 g/km	0.00	0.00
B	101 to 110 g/km	0.00	20.00
C	111 to 120 g/km	0.00	30.00
D	121 to 130 g/km	0.00	110.00
E	131 to 140 g/km	130.00	130.00
F	141 to 150 g/km	145.00	145.00
G	151 to 165 g/km	180.00	180.00
H	166 to 175 g/km	295.00	205.00
I	176 to 185 g/km	350.00	225.00
J	186 to 200 g/km	490.00	265.00
K	201 to 225 g/km	640.00	290.00
L	226 to 255 g/km	870.00	490.00
M	over 255 g/km	1,100.00	505.00

<sup>1</sup>For further information on vehicle taxation please refer to <http://carfueldata.direct.gov.uk/>

# Services and benefits

## Mercedes-Benz Service Care

We believe that servicing costs should be as flexible and affordable as possible for your S-Class, which is why we offer Service Care, an easy way to budget for all your servicing costs. It spreads your bills into manageable payments based on whether you have a new or used Mercedes-Benz.

With Service Care we guarantee the price of parts and labour for up to four services and safeguard against further inflation. It also covers the cost of all recommended service items including brake fluid, spark plugs, air filters, fuel filters and screen wash.

You can choose either to add your servicing costs into your monthly spend or pay the full amount in a one-off payment, giving you peace of mind that they are taken care of for the period of the plan.

To receive a personalised Service Care plan recommendation visit the Service Care Calculator at [www.mercedes-benz.co.uk/servicecare](http://www.mercedes-benz.co.uk/servicecare)

## Warranty and breakdown cover

Every Mercedes-Benz comes with a three-year unlimited mileage warranty against manufacturing or material defects<sup>1</sup> and up to 30 years warranty against perforation due to corrosion from the inside out.<sup>2</sup> What's more, it's also covered by Mercedes-Benz Roadside Assistance – a unique package comprising up to 30 years pan-European breakdown assistance.<sup>2</sup>

## Insurance

Since our name is synonymous with reliability, who better to trust with your motor insurance? Mercedes-Benz Insurance provides a motor insurance policy specifically designed to give you the cover you would expect from Mercedes-Benz. For a motor insurance quotation, call **0345 600 2180**.\*



> View offers



Book a > test drive

> AMG S 63 test drive  
> AMG S 65 test drive



> Find a Retailer



> View the Range Guide

56



# The Mercedes that thinks and acts for you.

## Imagine if...

### ...you could connect with your Mercedes-Benz?

With Mercedes connect me, you can; with Remote Online services<sup>1</sup> that include trip planning, maintenance management and vehicle tracking, plus more.

Getting connected is easy. Just set up your Mercedes me account and get in touch with your Mercedes-Benz Retailer to connect your vehicle to your profile to access your Mercedes connect me services.

### ...you knew beforehand that you need to stop for fuel?

Simply check the fuel level and mileage range from your phone wherever you are. You can also check tyre pressure and washer fluid level. (For electric cars, you can check battery charge state.)

### ...your Mercedes could tell you where it's parked?

You no longer need to ask yourself where you left your car; with Mercedes connect me you can locate your car from your smartphone or tablet within a mile radius.



1. PARKED VEHICLE LOCATOR  
2. VEHICLE TRACKER

3. REMOTE RETRIEVAL OF VEHICLE STATUS  
4. PRE-ENTRY CLIMATE CONTROL FOR ELECTRIC DRIVE AND PLUG-IN HYBRID



### ...you could lock your Mercedes, even if you're miles away?

The uncertainty of whether you've forgotten to lock the car is only human. To make sure your Mercedes-Benz is safe and secure, you can simply lock the car remotely via your PC/Mac, tablet or smartphone.

### ...your Mercedes told you when your service is due?

Being connected means essential data is constantly sent to your Mercedes-Benz Retailer so they know when it is time for a service. Your Retailer can then contact you with a tailor-made service quote.

### ...your Retailer already knows which parts need replacing?

As surprising as this sounds, with telediagnosics your Retailer can recognise remotely if certain parts are due for replacement, contacting you to book an appointment and making sure the relevant parts are in stock when you arrive, getting you back on the road as quickly as possible.

### ...you could just push a button to deal with a breakdown?

Should your car break down, with a simple press of the button everything is taken care of – from breakdown assistance to vehicle recovery.

### ...your Mercedes called for help?

Your Mercedes comes with an SOS button. Press it if you need urgent help and you will be contacted by the emergency response centre.<sup>2</sup> In the event of an accident where airbags or seatbelt tensioners have been activated, a call is placed automatically. Your GPS position is sent to the response teams to initiate rescue efforts.<sup>3</sup>

### The Mercedes that thinks and acts for you.

Contact your Retailer to get connected, or go to [www.mercedes.me](http://www.mercedes.me) for more details.

<sup>1</sup>This is available as an option in conjunction with Audio 20 CD, and standard with COMAND Online. Remote Online is standard with electric drive and plug-in hybrid. Use of the Remote Online equipment option is limited to three years from first registration of the vehicle and can then be extended at extra cost.

<sup>2</sup>A call is placed via the car's sim card, rather than the customer relying on their mobile phone.

<sup>3</sup>This feature is still available to customers without Mercedes connect me services. The customer is not required to accept the terms and conditions on the portal to activate this feature. For all other features the customer will have to accept terms and conditions on the portal to activate them.



> View offers



Book a > test drive

> AMG S 63 test drive  
> AMG S 65 test drive



> Find a Retailer



> View the Range Guide

# Mercedes-Benz Finance

## Why should you finance with Mercedes-Benz?

At Mercedes-Benz we believe a great driving experience should be matched by an equally great ownership experience. That is why we put just as much thought, time and effort into designing our finance options, our service plans and our insurance cover as we do into our vehicles.

We are not in the business of simply providing a loan to fund the purchase of your dream vehicle. We look on it as a journey that we take with you, from the moment you choose your new Mercedes-Benz, to helping you in choosing your next one.

If you would like to find out more about any of our current offers, simply call into your local Mercedes-Benz Retailer where one of our Business Managers will be more than happy to talk you through anything you need to know.

## Helping you find the right solution.

You should find our finance packages are more convenient than a traditional personal loan because:

- Funds are immediately available – no waiting for cheques or loans to clear.
- There is no security required – either against your home or other assets.
- We have clear and transparent rates – the APR we quote is the APR you get.
- We have friendly Business Managers – experts in vehicle finance who can talk you through all of your plans in detail.

One of our most popular finance products is Mercedes-Benz Agility (our Personal Contract Purchase product). We also offer Contract Hire, Operating Lease and Hire Purchase solutions. If you would like to find out more about these speak to your Retailer or visit [www.mercedes-benz.co.uk/fandi](http://www.mercedes-benz.co.uk/fandi).

## Mercedes-Benz Agility (our PCP product).

At the start of an Agility agreement, you put down a deposit and decide the term of your agreement and your annual mileage. You will be advised of the Guaranteed Future Value, which offers you the reassurance of knowing exactly what you will need to pay to own the vehicle outright in the future (this is known as the Optional Purchase Payment).

Throughout your agreement you simply pay your agreed monthly payments and when the agreement comes to an end you either purchase, hand back or part-exchange your vehicle.



### Agility features:

- Fixed regular payments mean you can easily budget.
- Payments are based only on a proportion of the vehicle's value, keeping your monthly payments lower.
- Our Guaranteed Future Value avoids the risk of unplanned depreciation of your vehicle.
- You defer your ownership decision until the end of the agreement.

### At the end of your agreement you have three options to choose from.

#### Option 1: Purchase your Mercedes-Benz.

Purchase your Mercedes-Benz by paying the Optional Purchase Payment and Purchase Activation Fee.<sup>1</sup> This will complete the purchase of your Mercedes-Benz, leaving you free to simply enjoy your vehicle.

#### Option 2: Hand back your Mercedes-Benz.

If you decide to return your vehicle to us, it must be in line with our Vehicle Return Standards,<sup>\*</sup> as vehicle condition, excess mileage and other charges may be payable.

#### Option 3: Part-Exchange for a new vehicle.

Purchase your Mercedes-Benz by paying the Optional Purchase Payment and Purchase Activation Fee.<sup>1</sup> This will complete the purchase of your Mercedes-Benz, leaving you free to part-exchange for a new vehicle.

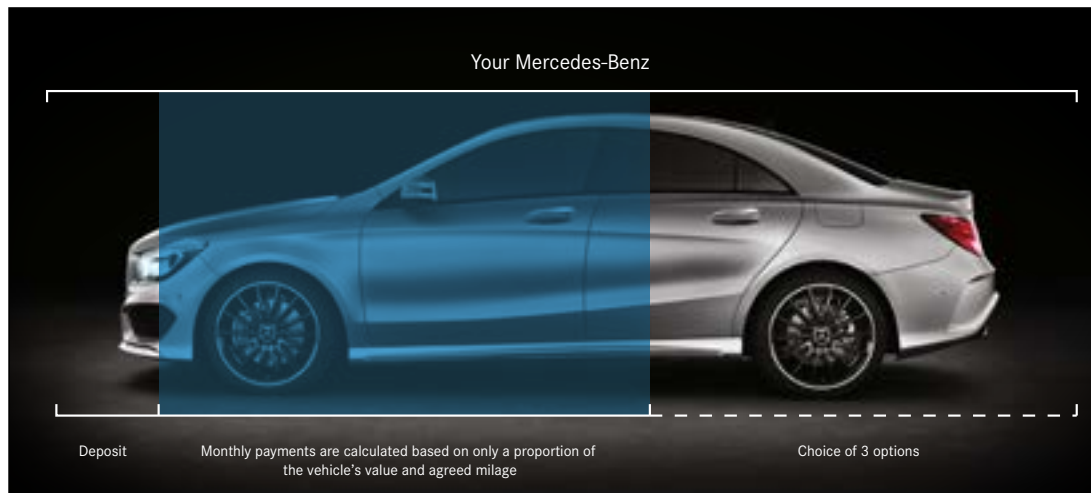

<sup>1</sup>Please note the 'Purchase Activation Fee' of £10 will be debited from your account \*To find out more information about our Vehicle Return Standards please visit <http://mercedes-benz.co.uk/vrs>



> View offers



Book a > test drive

> AMG S 63 test drive

> AMG S 65 test drive



> Find a Retailer



> View the Range Guide

Follow us on the following social media channels:



<https://www.facebook.com/MercedesBenzUk>



<https://twitter.com/mercedesbenzuk>



<https://www.youtube.com/mercedesbenzuk>



<https://instagram.com/mercedesbenzuk>

Effective from 1 September 2015. Information correct at time of going to print.

Prices and specifications are subject to change without prior notice.

MBC217PL/0915 MY 806 Production from 01.06.2015

Mercedes-Benz UK Ltd, Tongwell, Milton Keynes, MK15 8BA [www.mercedes-benz.co.uk](http://www.mercedes-benz.co.uk)



### Mixed Sources

Product group from well-managed forests, controlled sources and recycled wood or fibre  
[www.fsc.org](http://www.fsc.org) Cert no. SGS-COC-004556  
©1996 Forest Stewardship Council

