



[View offers](#)



[Book a test drive](#) [AMG test drive](#)



[Find a Retailer](#)



[View the Range Guide](#)

SL



Effective from 1 September 2015.

Mercedes-Benz





> View offers



Book a > test drive > AMG test drive



> Find a Retailer



> View the Range Guide

Contents

Model prices	11	Wheels	32	Road Fund Licence	56
Finance offers	12	Optional equipment	34	Services and insurance	57
Model lines	16	Genuine Accessories	46	Mercedes-Benz Finance	58
Mercedes-AMG driver training	24	Colours and materials	48		
Standard equipment	26	Technical data	52		



> View offers



Book a > test drive > AMG test drive



> Find a Retailer



> View the Range Guide

The hard facts to melt your heart

At Mercedes-Benz we appreciate the importance of detail. Over the following pages you'll find model prices and a breakdown of standard and optional equipment, as well as details of the comprehensive services and benefits that are available to every Mercedes-Benz driver.

See Mercedes-Benz in a new light. Now is the time to get yourself behind the wheel of an SL-Class. Choose from a number of attractive finance offers. Please see pages 12–15 for further details, or visit www.mercedes-benz.co.uk/offers

Of course, some things have to be experienced to be truly appreciated, such as the qualities that set a Mercedes-Benz apart. Which is why we'd like to invite you for a test drive at your local Mercedes-Benz Retailer. Alternatively, you can make arrangements by visiting www.mercedes-benz.co.uk/testdrive

For more information visit www.mercedes-benz.co.uk or call 0333 222 0500.



> View offers



Book a > test drive > AMG test drive



> Find a Retailer



> View the Range Guide

4





[View offers](#)



[Book a test drive](#) [AMG test drive](#)



[Find a Retailer](#)



[View the Range Guide](#)





> View offers



Book a > test drive > AMG test drive



> Find a Retailer



> View the Range Guide

6





> View offers



Book a > test drive > AMG test drive



> Find a Retailer



> View the Range Guide





> View offers



Book a > test drive > AMG test drive



> Find a Retailer



> View the Range Guide

8





[View offers](#)



[Book a test drive](#) [AMG test drive](#)



[Find a Retailer](#)



[View the Range Guide](#)





[View offers](#)



[Book a test drive](#) [AMG test drive](#)



[Find a Retailer](#)



[View the Range Guide](#)

10



[View offers](#)[Book a test drive](#) [AMG test drive](#)[Find a Retailer](#)[View the Range Guide](#)

Model prices

Engine	Model line	Transmission	CO ₂	Basic RRP excl. VAT (£)	Total RRP incl. VAT (£)	Road Fund Licence (£) ¹	Rec. OTR price (£) ²	P11D value (£)	BiK tax rate 2015/16 (%)
SL 400 Petrol - 2,996 cc, 6-cylinder, 333 hp/245 kW	AMG Sport	7G-TRONIC PLUS 7-speed auto.	179	60,462.50	72,555.00	350.00	73,575.00	73,170.00	30
	Mille Miglia 417 Edition	7G-TRONIC PLUS 7-speed auto.	179	70,262.50	84,315.00	350.00	85,335.00	84,930.00	30
SL 500 Petrol - 4,663 cc, 8-cylinder, 455 hp/335 kW	AMG Sport	7G-TRONIC PLUS 7-speed auto.	212	68,183.33	81,820.00	640.00	83,130.00	82,435.00	37
	Mille Miglia 417 Edition	7G-TRONIC PLUS 7-speed auto.	212	78,354.17	94,025.00	640.00	95,335.00	94,640.00	37
Mercedes-AMG									
Mercedes-AMG SL 63 Petrol - 5,461 cc, 8-cylinder, 585 hp/430 kW	-	AMG SPEEDSHIFT MCT 7-speed automatic	234	93,870.83	112,645.00	870.00	114,185.00	113,260.00	37
Mercedes-AMG SL 65 Petrol - 5,980 cc, 12-cylinder, 630 hp/463 kW	-	AMG SPEEDSHIFT PLUS 7G-TRONIC automatic	279	142,991.67	171,590.00	1,100.00	173,360.00	172,205.00	37

¹A different first year rate of Vehicle Excise Duty (Road Fund Licence) applies for new cars. Please refer to page 56 for the relevant rate for the second and subsequent years

²Recommended on-the-road price: these prices reflect the Road Fund Licence applicable to the standard model plus £670.00 additional costs necessary to put your car on the road.

Included are a standard UK delivery charge (£540.00 incl. VAT), new vehicle registration fee (£55.00), number plates (£25.00 incl. VAT) and fuel (£50.00 incl. VAT). VAT is calculated at the standard rate of 20%



Mercedes-Benz Finance

It comes with a specification list worth exploring

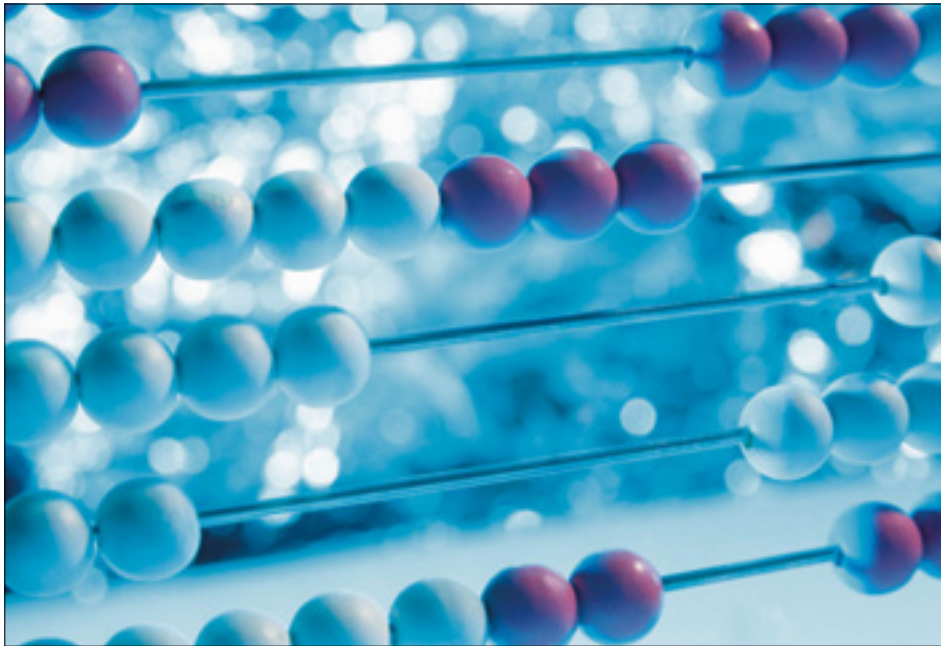

SL 400 AMG Sport with automatic transmission and metallic paint (representative example)

36 monthly payments of ¹	£799.00
On-the-road price	£73,575.00
Customer deposit	£7,499.00
Retailer deposit contribution	£13,917.50
Duration of agreement	36 months
Optional purchase payment ²	£31,225.00
Purchase activation fee ²	£10.00
Amount of credit	£52,158.50
Total amount payable ³	£81,415.50
Representative APR	6.4% APR
Fixed interest rate	6.17%



**Example offer –
6.4% APR Representative**

	Automatic	Metallic	On-the-road price	Retailer deposit contribution	Customer deposit	36 monthly payments of ¹
SL 400 AMG Sport	●	●	£73,575.00	£13,917.50	£7,499.00	£799.00

● Standard equipment

Mercedes-Benz Service Care

- Mercedes-Benz trained Technicians
- Maintained by Mercedes-Benz Retailers
- Meets requirements of Mercedes-Benz Agility finance agreement

Mercedes-Benz Motor Insurance

- 24/7 UK accident recovery
- We use Mercedes-Benz GenuineParts
- To qualify for up to 10% discount online, go to www.mercedes-benz.co.uk/motorinsurance
- Alternatively, call Mercedes-Benz Motor Insurance now on **0345 600 2180⁴** for an annual quote

We may decline to quote in some circumstances. Mercedes-Benz Motor Insurance is underwritten by Aviva Insurance Limited

Whilst these offers are only available with Mercedes-Benz Finance, our Mercedes-Benz Retailers do arrange finance on behalf of other finance companies as well

Orders/credit approvals on selected SL models between 1 October and 31 December 2015, registered by 31 March 2016; excluding AMG SL 63 and AMG SL 65 models. Some combinations of features/options may not be available.

Please contact your local Mercedes-Benz Retailer for availability

¹Based on a Mercedes-Benz Agility agreement and 10,000 miles per annum. Vehicle condition, excess mileage and other charges may be payable. Quotations available on request for alternative contract lengths and mileages.

Guarantees and indemnities may be required. Terms and Conditions apply. Credit provided subject to status by Mercedes-Benz Financial Services UK Ltd, MK15 8BA

²Payable if you exercise the option to purchase the car. Guaranteed future value if you choose to hand back the vehicle at the end of the contract

³Includes optional purchase payment, purchase activation fee and Retailer deposit contribution ⁴ Calls are charged at local rate and may be recorded



Mercedes-Benz Finance

Even the finance offer is beautifully put together

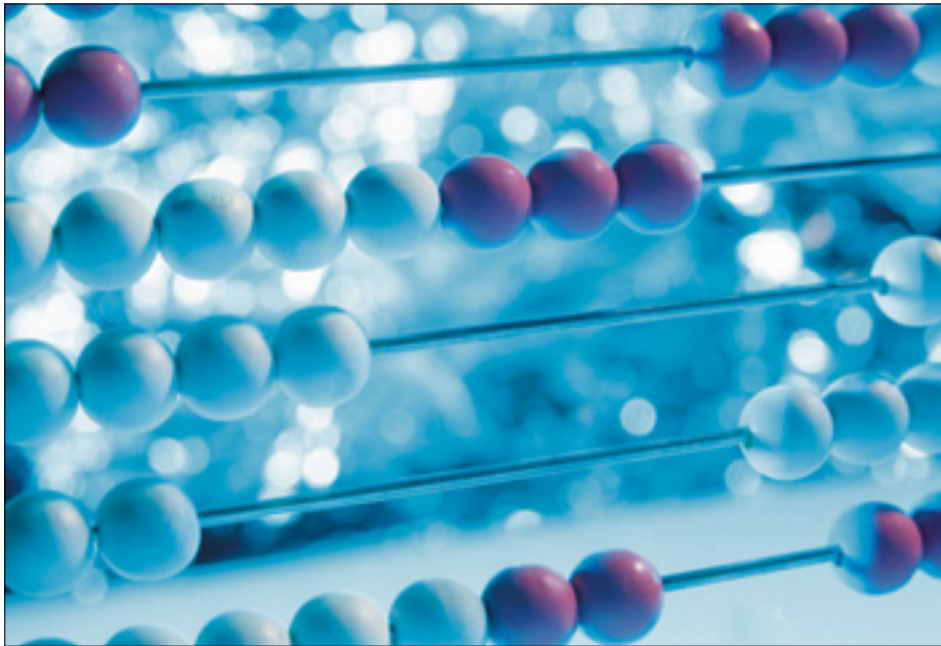

Mercedes-AMG SL 63 with automatic transmission and metallic paint (representative example)

36 monthly payments of ¹	£1,165.00
On-the-road price	£114,185.00
Customer deposit	£21,415.38
Retailer deposit contribution	£10,754.62
Duration of agreement	36 months
Optional purchase payment ²	£5,125.00
Purchase activation fee ²	£10.00
Amount of credit	£82,015.00
Total amount payable ³	£125,370.00
Representative APR	5.7% APR
Fixed interest rate	5.52%



Example offer – 5.7% APR Representative

	Automatic	Metallc	On-the-road price	Retailer deposit contribution	Customer deposit	36 monthly payments of ¹
Mercedes-AMG SL 63	●	●	£114,185.00	£10,754.62	£21,415.38	£1,165.00

● Standard equipment

Mercedes-Benz Service Care

- Mercedes-Benz trained Technicians
- Maintained by Mercedes-Benz Retailers
- Meets requirements of Mercedes-Benz Agility finance agreement

Mercedes-Benz Motor Insurance

- 24/7 UK accident recovery
- We use Mercedes-Benz GenuineParts
- To qualify for up to 10% discount online, go to www.mercedes-benz.co.uk/motorinsurance
- Alternatively, call Mercedes-Benz Motor Insurance now on **0345 600 2180⁴** for an annual quote

We may decline to quote in some circumstances. Mercedes-Benz Motor Insurance is underwritten by Aviva Insurance Limited

Whilst these offers are only available with Mercedes-Benz Finance, our Mercedes-Benz Retailers do arrange finance on behalf of other finance companies as well

Orders/credit approvals on Mercedes-AMG SL models between 1 October and 31 December 2015, registered by 31 March 2016; excluding non-AMG models. Some combinations of features/options may not be available.

Please contact your local Mercedes-Benz Retailer for availability

¹Based on a Mercedes-Benz Agility agreement and 10,000 miles per annum. Vehicle condition, excess mileage and other charges may be payable. Quotations available on request for alternative contract lengths and mileages.

Guarantees and indemnities may be required. Terms and conditions apply. Credit provided subject to status by Mercedes-Benz Financial Services UK Ltd, MK15 8BA

²Payable if you exercise the option to purchase the car. Guaranteed future value if you choose to hand back the vehicle at the end of the contract

³Includes optional purchase payment, purchase activation fee and Retailer deposit contribution ⁴Calls are charged at local rate and may be recorded



> View offers



Book a > test drive > AMG test drive



> Find a Retailer



> View the Range Guide

16

SL 400 and SL 500 AMG Sport



The AMG Sport in designo hyacinth red (code 996)¹

¹Please check with your Retailer for availability



The AMG Sport's eye-catching rear apron



19" AMG 5-spoke alloy wheels (code 770)



> View offers



Book a > test drive > AMG test drive



> Find a Retailer



> View the Range Guide

The SL 400 and SL 500 AMG Sport feature AMG front and rear aprons and side skirts, the boot lid spoiler in body colour, 19" AMG 5-spoke alloy wheels and sports suspension for a tighter, more athletic drive. A host of eye-catching features are included in the interior too: an instrument cluster with a chequered flag design, a flat-bottomed sports steering wheel with silver gearshift paddles and perforated leather in the grip areas, plus

brushed light aluminium trim and AMG floor mats. The model-specific sports seats feature black perforated leather with vertical fluting, and piping in designo platinum white pearl on door armrests, centre console, seat side bolsters and head restraints. Nappa leather, in either bengal red or porcelain, is available as an option.

Exterior

- 19" AMG alloy wheels (4) - 5-spoke design, front tyres 255/35, rear 285/30
- AMG bodystyling - front and rear aprons, side skirts and boot lid spoiler in body colour
- Active Parking Assist with PARKTRONIC
- Braking system with perforated rear brake discs
- Grey brake calipers with 'Mercedes-Benz' lettering
- Panoramic vario-roof with blind - operable via infrared key
- Sports suspension, lowered, with stiffened suspension and damper settings

Interior

- AMG floor mats
- Chequered flag-design instrument cluster
- Roof lining in black fabric
- Sports seats with perforated leather, vertical fluting and designo platinum white pearl piping on door armrests, centre console, seat side bolsters and head restraints
- Steering wheel - 4-spoke multi-function sports steering wheel with silver gearshift paddles, trimmed in nappa leather with perforated grip areas

Trim and Upholstery

Light brushed aluminium

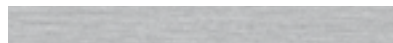

Leather - black





> View offers



Book a > test drive > AMG test drive



> Find a Retailer



> View the Range Guide

18

SL 400 and SL 500 Mille Miglia 417 Edition



The Mille Miglia 417 Edition in designo magno night black (code 056)



AMG line fin in red with AMG rear spoiler in matt carbon



Seats in black with contrast areas and piping in classic red



The new SL Mille Miglia 417 Edition commemorates an unforgettable moment in our racing history. Sixty years ago the legendary production car 300 SL won the Mille Miglia, one of the world's most challenging long-distance races. The passion and winning spirit of the car with the starting

number 417 lives on in this model, available as an SL 400 or SL 500 model. It celebrates innovative roadster comfort and maximum performance with the most exclusive features.

Exterior

19"/20" AMG alloy wheels in matt black and red

Active Parking Assist with reversing camera

Brake calipers, painted red with 'Mercedes-Benz' lettering

Front spoiler lip, painted red, AMG rear spoiler in matt carbon with red line fin

'SL Mille Miglia 417' logo on front wing

Interior

Active Multi-Contour Seat package with massage function

AIRSCARF - neck-level heating

KEYLESS-GO Comfort package, including remote boot closing and hands-free access

Analogue clock - in the centre of the dashboard

Ambient lighting - choice of three colour settings

Centre console in black with piping and side parts in classic red

Cup holders in centre console

Door trim and centre console with classic red accents

Floor mats in black with classic red edging and '1000 Miglia' logo

Headrests with carbon fibre stamping and Edition logo

Panoramic glass vario-roof with MAGIC SKY CONTROL - switchable transparency

Seats - comfort-ventilated, in black nappa leather with classic red accents and designo red seatbelts

Steering wheel - nappa leather steering wheel in classic red and black with carbon stamping

Surround sound system - Harman Kardon® Logic 7® with Dolby Digital 5.1 and DTS 10-channel DSP amplifier with 9 high-performance speakers and Frontbass, 600 watt output

Wind deflector - electrically operated

Paint, Trim and Upholstery

049 designo cashmere white magno

056 designo night black magno

183 magnetite black metallic

799 designo diamond white

AMG matt black carbon fibre

Nappa leather - black with highlights and piping in classic red



> View offers



Book a > test drive > AMG test drive



> Find a Retailer



> View the Range Guide

20

Mercedes-AMG SL 63



The Mercedes-AMG SL 63 offers exceptional performance. Shown here with optional wheels in 10-spoke design



AMG sports exhaust system: two sets of twin chromed tailpipes



AMG sports seats in nappa leather



> View offers



Book a > test drive > AMG test drive



> Find a Retailer



> View the Range Guide

The Mercedes-AMG SL 63 says performance even at a standstill. Its muscular AMG bodystyling comprises side skirts, a front apron with side air vents and a rear apron with a body-colour diffuser-style insert, while AMG 5-twin-spoke alloy wheels further add to the dynamic look. The front apron's cross-bar, the bonnet and side fins, the twin-louvre AMG radiator grille boast silver chrome trim and there are 'V8 BITURBO' badges on the front wings.

Climb inside and the racing feel is unmistakable, thanks to the combination of nappa leather-trimmed AMG performance steering wheel with aluminium gearshift paddles, AMG DRIVE UNIT with E-SELECT shift lever and AMG instrument panel with AMG start-up screen and Racetimer function for recording lap times. The nappa leather AMG sports seats feature model-specific stitching and are complemented by AMG carbon fibre interior trim.

Exterior

19" AMG alloy wheels (4) – 5 twin-spoke design, painted in titanium grey, front tyres 255/35, rear 285/30

AMG radiator grille – twin-louvre in silver chrome

AMG rear axle limited-slip differential lock

AMG SPEEDSHIFT MCT 7-speed automatic sports transmission with four driving modes, RACE START function and ECO start/stop function

AMG sports exhaust system with two chromed twin tailpipes

AMG sports suspension based on Active Body Control (ABC) – active suspension system, adjustable in two stages

Panoramic vario-roof with blind

'V8 BITURBO' lettering on front wings

Interior

3-spoke multi-function AMG performance steering wheel

AMG door sill panels in brushed stainless steel, illuminated in white

AMG instrument cluster – twin-tube look with TFT multi-function colour display including AMG main menu and AMG start-up screen display

AMG sports seats with AMG-specific seat upholstery and embossed AMG emblem in backrests

Seats – multi-contour, heated

Trim and Upholstery

AMG carbon fibre



Nappa leather – black

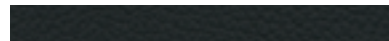

Nappa leather – ginger beige/espresso brown



Nappa leather – bengal red



Nappa leather – porcelain





> View offers



Book a > test drive > AMG test drive



> Find a Retailer



> View the Range Guide

22

Mercedes-AMG SL 65



The Mercedes-AMG SL 65 combines exhilarating performance and exclusive luxury



AMG sports exhaust system with model-specific twin tailpipes



AMG sports seats in Exclusive nappa leather



> View offers



Book a > test drive > AMG test drive



> Find a Retailer



> View the Range Guide

The Mercedes-AMG SL 65 features details such as model-specific chromed twin tailpipes, 'V12 BITURBO' badges on the front wings and the front apron's high-gloss chromed cross-bar. The twin-louvre AMG radiator grille, bonnet and side fins are also finished in high-gloss chrome, and there are 19" AMG 5-spoke alloy wheels as standard. Inside, there's an unmistakable air of luxury, thanks to comfort-ventilated multi-contour seats, Exclusive

nappa leather upholstery with embossed 'AMG' backrest badges and diamond-pattern stitching, and a black designo leather roof lining. High-sheen chrome AMG door sill panels with white backlighting guarantee an eye-catching welcome, while the Bang & Olufsen BeoSound AMG surround sound system provides a suitably high-end acoustic backdrop.

Exterior

19" AMG alloy wheels (4) – 5-spoke design, painted in titanium grey with high-sheen finish, front tyres 255/35, rear 285/30

AMG radiator grille – twin-louvre in high-gloss chrome

AMG rear axle limited-slip differential lock

AMG SPEEDSHIFT MCT 7-speed automatic sports transmission with four driving modes and ECO start/stop function

AMG sports exhaust system with two sets of twin chromed tailpipes in AMG 'V12' design

AMG sports suspension based on Active Body Control (ABC) – active suspension system, adjustable in two stages

'V12 BITURBO' lettering on front wings

Interior

KEYLESS-GO Comfort package, including remote boot closing and hands-free access

3-spoke multi-function AMG performance steering wheel

AIRSCARF – neck-level heating

AMG door sill panels in high-sheen chrome, illuminated in white

AMG instrument cluster – twin-tube look with TFT multi-function colour display including AMG main menu and AMG 'V12 BITURBO' start-up screen display

AMG multi-contoured and comfort-ventilated sports seats with AMG-specific 'V12' seat upholstery and embossed AMG emblem in backrests

Trim and Upholstery

AMG carbon fibre



Exclusive nappa leather – black



Exclusive nappa leather – ginger beige/espresso brown

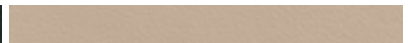

Exclusive nappa leather – bengal red



Exclusive nappa leather – porcelain

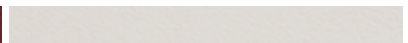



> View offers



Book a > test drive > AMG test drive



> Find a Retailer



> View the Range Guide

24

Exclusive driver training for Mercedes-AMG owners

All Mercedes-AMG customers are invited to a complimentary AMG Driving Academy Training experience at Mercedes-Benz World.



With friendly one-to-one tuition from a professional Mercedes-AMG driver, your training will be personalised to you. You'll push Mercedes-AMG driving performance and your driving skills to the limits on our track and purpose-built low friction dynamic handling facilities.

Through high-speed and adrenaline-fuelled exercises you'll experience oversteer, understeer, slaloms and many more performance driving skills. Designed as part of your ownership experience, this will lay the foundations to master a high-performance vehicle, develop driving skills with maximum enjoyment and prepare you to take full command of your own Mercedes-AMG.

TERMS AND CONDITIONS: Only the first purchaser/registered keeper of a newly registered Mercedes-AMG is eligible for this complimentary AMG Driving Academy Training experience which is the AMG BASIC-Training as detailed above. The Training experience must be booked and taken within six months of delivery of your Mercedes-AMG; it cannot be exchanged and cannot be transferred for any other driving experience. The Training experience is available Monday to Friday only and is subject to availability. Mercedes-Benz UK Limited reserves the right to amend or withdraw this Training experience. Attendees must hold a full UK driving licence. Attendees will be required to sign the Mercedes-Benz World Driving Risk Acknowledgement prior to undertaking the Training experience. The Training experience is also subject to full Terms and Conditions, which are available on request.



[View offers](#)



[Book a test drive](#) [AMG test drive](#)



[Find a Retailer](#)



[View the Range Guide](#)





> View offers



Book a > test drive > AMG test drive



> Find a Retailer



> View the Range Guide

Standard equipment



Adaptive Damping System (ADS) with Sport and Comfort modes

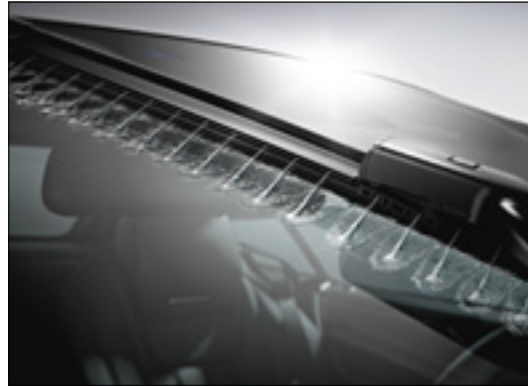

MAGIC VISION CONTROL – adaptive windscreen wiper system



Intelligent Light System



DIRECT SELECT gear selector in the centre console



Multi-function sports steering wheel with nappa leather trim



COMAND Online system with single-disc CD/DVD changer



Item	AMG Sport	Mille Miglia 417 Edition	Mercedes-AMG SL 63	Mercedes-AMG SL 65
Transmission and Suspension				
7G-TRONIC PLUS 7-speed automatic transmission with cruise control, SPEEDTRONIC variable speed limiter, steering wheel gearshift paddles and 'S' mode featuring modified shift points	●	●	-	-
AMG SPEEDSHIFT MCT 7-speed automatic sports transmission with four driving modes ('Controlled Efficiency', 'Sport', 'Sport Plus' and 'Manual'), RACE START function	-	-	●	-
AMG SPEEDSHIFT PLUS 7G-TRONIC automatic transmission with four driving modes ('Controlled Efficiency', 'Sport', 'Sport Plus' and 'Manual')	-	-	-	●
AMG sports suspension based on Active Body Control (ABC) – active suspension system, adjustable in two stages	-	-	●	●
AMG rear axle limited-slip differential lock	-	-	●	●
ECO start/stop function	●	●	●	●
Sports suspension with Adaptive Damping System	●	●	-	-
Torque Vectoring Brake	●	●	●	●
Exterior				
KEYLESS-GO Comfort package KEYLESS-GO, remote boot opening and closing (code 881) and hands-free access. The vehicle can be conveniently unlocked, started and locked with this access and drive authorisation system – simply by carrying the electronic key. The vario-roof can be opened and closed remotely by means of the vehicle key	○	●	○	●

Item	AMG Sport	Mille Miglia 417 Edition	Mercedes-AMG SL 63	Mercedes-AMG SL 65
Exterior (continued)				
Active Parking Assist with PARKTRONIC PARKTRONIC monitors the front and rear end whilst the driver is manoeuvring the vehicle and gives a warning if the risk of a collision is detected. Active Parking Assist makes it easier to find a parking space and also automatically steers the vehicle into parking spaces	●	-	●	●
Active Parking Assist with PARKTRONIC and reversing camera	-	●	-	-
AMG bodystyling Mercedes-AMG SL 63-specific front apron featuring cross strut painted in silver chrome and side air outlets, rear apron with diffuser look with insert in vehicle colour and side sill panels	-	-	●	-
AMG bodystyling Mercedes-AMG SL 65-specific front apron featuring cross strut in high-gloss chrome and side air outlets, rear apron with diffuser look with insert in vehicle colour and side sill panels	-	-	-	●
AMG bodystyling – front and rear aprons, side skirts	●	●	-	-
AMG boot lid spoiler	●	●	●	●
AMG high-performance braking system with 390 × 36 mm composite front brake discs and 360 × 26 mm rear brake discs	-	-	●	●
AMG radiator grille – twin-louvre in silver chrome	-	-	●	-
AMG radiator grille – twin-louvre in high-gloss chrome	-	-	-	●
AMG sports exhaust system with two chromed twin tailpipes	-	-	●	-



Standard equipment

Item	AMG Sport	Mille Miglia 417 Edition	Mercedes-AMG SL 63	Mercedes-AMG SL 65
Exterior (continued)				
AMG sports exhaust system with two sets of twin chromed tailpipes in AMG 'V12' design	-	-	-	●
Brake calipers, painted grey with 'AMG' lettering	-	-	●	●
Brake calipers, painted grey with 'Mercedes-Benz' lettering	●	-	-	-
Brake calipers, painted red with 'Mercedes-Benz' lettering	-	●	-	-
Braking system with perforated rear brake discs	●	●	-	-
Closing aid for doors When initially engaged, the doors are automatically closed by servo motors, ensuring smooth and virtually silent closing	○	○	○	●
Door mirrors – electrically operated, folding and heated	●	●	●	●
Headlamps – Intelligent Light System Bi-xenon headlamps, LED daytime running lamps (AMG-specific design on AMG models), Active Light System, cornering light function, headlamp wash and Adaptive Highbeam Assist	●	●	●	●
High-level LED third brake lamps	●	●	●	●
MAGIC VISION CONTROL Allows the driver the best possible visibility even during the wiping process. Washer fluid is sprayed directly in front of the wiper blades and wiped away without delay. A heating system effectively lowers the risk of icing up	●	●	●	●
Panoramic vario-roof with blind – operable via infrared key	●	●	●	●
Tinted glass – green	●	●	●	●

Item	AMG Sport	Mille Miglia 417 Edition	Mercedes-AMG SL 63	Mercedes-AMG SL 65
TIREFIT tyre-sealant kit	●	●	●	●
'V8 BITURBO' lettering on front wings	-	-	●	-
'V12 BITURBO' lettering on front wings	-	-	-	●
Interior				
Active Multi-Contour Seat package with massage function	○	●	○	○
Memory package Front seats with four-way lumbar support, steering column and exterior door mirrors – electrically adjustable with memory	●	●	●	●
AIRSCARF – neck-level heating	○	●	○	●
Ambient lighting – choice of three colour settings	○	●	●	●
AMG door sill panels in brushed stainless steel, illuminated in white	-	-	●	-
AMG door sill panels in high-sheen chrome, illuminated in white	-	-	-	●
AMG floor mats	●	-	●	●
AMG instrument cluster – twin-tube look with TFT multi-function colour display including AMG main menu and AMG start-up screen display	-	-	●	-
AMG instrument cluster – twin-tube look with TFT multi-function colour display including AMG main menu and AMG 'V12 BITURBO' start-up screen display	-	-	-	●
AMG-specific IWC-design analogue clock	-	-	●	●



Item	AMG Sport	Mille Miglia 417 Edition	Mercedes-AMG SL 63	Mercedes-AMG SL 65
Interior (continued)				
AMG sports seats with AMG-specific seat upholstery and embossed AMG emblem in backrests	-	-	●	-
AMG sports seats with AMG-specific 'V12' seat upholstery and embossed AMG emblem in backrests	-	-	-	●
Analogue clock – in the centre of the dashboard	○	●	-	-
Cup holders in centre console	○	●	○	○
designo seat belts – red	-	●	○	○
Door centre panels – AMG 'V12' diamond pattern	-	-	-	●
Door sill panels with 'Mercedes-Benz' lettering	●	●	-	-
Electric windows (2)	●	●	●	●
Floor mats in black with classic red edging and '1000 Miglia' logo	-	●	-	-
Instrument cluster with chequered flag design	●	●	-	-
Outside temperature gauge	●	●	●	●
Panoramic vario-roof with MAGIC SKY CONTROL The panoramic roof changes from dark to transparent or vice versa within a few seconds. In its tinted state, it substantially reduces heating-up of the vehicle interior	○	●	○	○
Seats – heated	●	-	●	-
Seats – comfort-ventilated	○	●	○	●

Item	AMG Sport	Mille Miglia 417 Edition	Mercedes-AMG SL 63	Mercedes-AMG SL 65
Seats – multi-contour	○	●	●	●
Seats – sports seats with perforated leather, vertical fluting and designo platinum white pearl piping on door armrests, centre console, seat side bolsters and head restraints	●	-	-	-
Seats – sports seats in perforated black nappa leather with contrast areas and piping in classic red	-	●	-	-
Service indicator ASSYST	●	●	●	●
THERMOTRONIC – luxury automatic climate control	●	●	●	●
Wind deflector – electrically operated	○	●	○	○
Wind deflector (fabric) The fabric wind deflector provides draught protection in high winds and cooler weather conditions. It slots in between the roll-over bars and can be fitted or removed quickly and easily	●	-	●	●
Steering				
3-spoke multi-function AMG performance steering wheel with 12 buttons, trimmed in nappa leather with flattened top and bottom sections and silver-coloured aluminium gearshift paddles	-	-	●	●
3-spoke multi-function sports steering wheel with flattened bottom section, 12 buttons and silver gearshift paddles, trimmed in nappa leather with perforated grip areas	●	●	-	-



Standard equipment

Item	AMG Sport	Mille Miglia 417 Edition	Mercedes-AMG SL 63	Mercedes-AMG SL 65
Steering (continued)				
AMG speed-sensitive sports steering with two sets of steering characteristics depending on the suspension setting	-	-	●	●
Parameter steering – speed-sensitive power steering	●	●	-	-
Paint, Trim and Upholstery				
Paint – metallic	●	●	●	●
Roof lining – black fabric	●	●	-	-
Roof lining – designo leather	-	-	○	●
Trim – AMG carbon fibre	-	-	●	●
Trim – AMG matt black carbon fibre	-	●	-	-
Trim – light brushed aluminium	●	-	-	-
Upholstery – Exclusive nappa leather, perforated	-	-	-	●
Upholstery – nappa leather, perforated	-	-	●	-
Upholstery – perforated leather, vertical fluting and designo platinum white pearl piping on door armrests, centre console, seat side bolsters and head restraints	●	-	-	-
Upholstery – perforated nappa leather in black with contrast areas and piping in classic red	-	●	-	-

Item	AMG Sport	Mille Miglia 417 Edition	Mercedes-AMG SL 63	Mercedes-AMG SL 65
Security and Safety				
Driving Assistance package Active Blind Spot Assist, Active Lane Keeping Assist and DISTRONIC PLUS with PRE-SAFE® Brake	○	○	○	●
Active bonnet – pedestrian safety measure	●	●	●	●
Adaptive brake lamps	●	●	●	●
ADAPTIVE BRAKE system with HOLD function	●	●	●	●
Airbags – driver’s kneebag	-	-	●	●
Airbags – dual-stage, driver and front passenger	●	●	●	●
Airbags – head and sidebags, driver and front passenger	●	●	●	●
Alarm system with immobiliser and interior protection (MBSS3)	●	●	●	●
Anti-lock braking system (ABS) with Brake Assist (BAS)	●	●	●	●
ATTENTION ASSIST Monitors steering behaviour and can help alert to long journey fatigue	●	●	●	●
Automatic child seat recognition sensor Works in conjunction with Mercedes-Benz child seats fitted with transponder	●	●	●	●
Automatically dimming rear-view mirror and driver’s door mirror	●	●	●	●
Electric parking brake	●	●	●	●



Item	AMG Sport	Mille Miglia 417 Edition	Mercedes-AMG SL 63	Mercedes-AMG SL 65
Security and Safety (continued)				
Electronic Stability Programme (ESP®) with Acceleration Skid Control (ASR)	●	●	●	●
First-aid kit and warning triangle	●	●	●	●
Headlamp Assist - automatic headlamp activation	●	●	●	●
Heated rear window with timer control	●	●	●	●
Locking wheel bolts	●	●	●	●
NECK-PRO active head restraints In a rear-end collision, the crash-responsive head restraints can be pushed forward by around 40 mm and upwards by around 30 mm. This enables the head to be supported at an earlier stage and the risk of whiplash injury to be reduced	●	●	●	●
PRE-SAFE® anticipatory safety system	●	●	●	●
Rain-sensing wipers	●	●	●	●
Remote central locking	●	●	●	●
Roll-over bars with crash sensor, automatically raising	●	●	●	●
Seat belt pre-tensioners	●	●	●	●
Tyre pressure monitoring system Tyre pressure of all four wheels is continuously monitored by sensors and indicated on the multi-function display in the cockpit. Displayed figure in white or amber and red as warning	●	●	●	●

Item	AMG Sport	Mille Miglia 417 Edition	Mercedes-AMG SL 63	Mercedes-AMG SL 65
Communications and In-Car Entertainment				
8 speakers with Frontbass	●	●	●	-
Bluetooth® interface for hands-free telephony	●	●	●	●
Central controller dial to operate audio functions and telephone (when connected)	●	●	●	●
COMAND Online system with Media Interface Includes radio, single CD/DVD, 7-inch colour display, hard disk drive (HDD) navigation with 3D map display, Live Traffic Information and European map data updates free of charge for the first three years, and LINGUATRONIC voice control. Internet-enabled mobile phone required for emergency call system (eCall), Mercedes-Benz apps and in-car internet access for Facebook, internet radio, sending routes from Google Maps™ to the vehicle, news and weather reports. Also includes SD memory card slot, 10 GB music register and MP3 compatibility. Media Interface allows connection and control of portable media devices (e.g. MP3 player, USB storage media). Cable included for iPod® connectivity	●	●	●	●
DAB digital radio tuner Provides wide range of programmes with excellent reception quality and useful supplementary information, e.g. on traffic conditions or radio programme	●	●	●	●
Surround sound system - Bang & Olufsen BeoSound AMG High-end sound system with 12 speakers and Frontbass, speaker covers in aluminium, two LED-illuminated tweeters featuring Acoustic Lens Technology, 900 watt output	-	-	○	●
Surround sound system - Harman Kardon® Logic 7® with Dolby Digital 5.1 and DTS 10-channel DSP amplifier with 9 high-performance speakers and Frontbass, 600 watt output	○	●	-	-
Telephone pre-wiring with hands-free facility	○	○	○	●



A revolution in style

Item	Notes		AMG Sport	Mille Miglia 417 Edition	Mercedes-AMG SL 63	Mercedes-AMG SL 65	Basic RRP excl. VAT (£)	Total RRP incl. VAT (£)
19" AMG alloy wheels (4) – 5-spoke design front: 255/35 tyres rear: 285/30 tyres			770	●	-	-	-	-
19" AMG alloy wheels (4) – 7-twin-spoke design, painted in titanium grey with high-sheen finish front: 255/35 tyres rear: 285/30 tyres			785	○	-	-	425.00	510.00
19" AMG alloy wheels (4) – 7-twin-spoke design, painted in black with high-sheen finish front: 255/35 tyres rear: 285/30 tyres			662	○	-	-	425.00	510.00
19" AMG alloy wheels (4) – 5-twin-spoke design, painted in titanium grey front: 255/35 tyres rear: 285/30 tyres			793	-	-	●	-	-

[View offers](#)[Book a test drive](#) > [AMG test drive](#)[Find a Retailer](#)[View the Range Guide](#)

Item	Notes		797	-	-	-	●		Basic RRP excl. VAT (£)	Total RRP incl. VAT (£)	
Wheels (continued)			AMG Sport	Mille Miglia 417 Edition	Mercedes-AMG SL 63	Mercedes-AMG SL 65					
19" AMG alloy wheels (4) – 5-spoke design, painted in titanium grey with high-sheen finish front: 255/35 tyres rear: 285/30 tyres			797	-	-	-	●		-	-	
19"/20" AMG alloy wheels (4) – 10-spoke design, painted in matt black and red front: 255/35 tyres rear: 285/30 tyres			697	-	●	-	-		-	-	
19"/20" AMG alloy wheels (4) – 10-spoke design, painted in titanium grey front: 255/35 tyres rear: 285/30 tyres			766	-	-	○	○		1,700.00	2,040.00	
19"/20" AMG alloy wheels (4) – 10-spoke design, matt black front: 255/35 tyres rear: 285/30 tyres			767	-	-	○	○		2,133.33	2,560.00	



> View offers



Book a > test drive > AMG test drive



> Find a Retailer



> View the Range Guide

34

Optional equipment



KEYLESS-GO Comfort package with hands-free boot access



Active Lane Keeping Assist (part of Driving Assistance package)



Analogue clock



Ambient lighting



Reversing camera



Panoramic vario-roof with MAGIC SKY CONTROL



Item	Notes	AMG Sport	Mille Miglia 417 Edition	Mercedes-AMG SL 63	Mercedes-AMG SL 65	Basic RRP excl. VAT (£)	Total RRP incl. VAT (£)	
AMG Performance Studio								
AMG Driver's package Attendance at an AMG 'Power & Passion' driving event Increase to the electronically limited top speed	Not in conjunction with omission of AMG boot lid spoiler (code U46)	250	-	-	○	○	2,354.17	2,825.00
AMG Exterior Carbon-Fibre package Cross strut on front apron, exterior mirror housings, AMG carbon-fibre boot lid spoiler		773	-	-	○	○	2,525.00	3,030.00
AMG carbon-fibre engine cover High quality genuine carbon-fibre engine cover emphasises vehicle's sportiness		B14	-	-	○	-	1,316.67	1,580.00
AMG high-performance ceramic composite braking system		B07	-	-	○	○	8,354.17	10,025.00
AMG Performance Media – captures and displays vehicle-specific data as well as racetrack information Information is shown on COMAND display, and data can be saved and exported for subsequent evaluation, enabling ambitious drivers to analyse their driving skills precisely and then set about improving specific aspects of their abilities. Key functions include: – Real-time display of lateral and linear acceleration combined with braking performance – Recording of individual lap times on a closed-off racetrack, with sector times and memory function – Real-time display of acceleration time from 0–62 mph (alternatively ¼ mile) – Real-time display of engine oil, coolant and transmission fluid temperature – Real-time display of engine output, torque and accelerator position – Programming of the Race Start vehicle settings		255	-	-	○	○	1,700.00	2,040.00



Item	Notes		AMG Sport	Mille Miglia 417 Edition	Mercedes-AMG SL 63	Mercedes-AMG SL 65	Basic RRP excl. VAT (£)	Total RRP incl. VAT (£)
AMG Performance Studio (continued)								
AMG Performance suspension, lowered Based on Active Body Control (ABC) – adjustable in two stages		486	-	-	○	-	1,308.33	1,570.00
Suspension and Exterior								
Active Body Control (ABC) – active suspension system Provides enhanced ride comfort as well as improved driving dynamics. The combination of an active suspension with passive damping reduces pitching motions when pulling away or braking as well as rolling motions during cornering	Replaces standard lowered sports suspension	487	○	○	●	●	2,566.67	3,080.00
Brake calipers, painted red	Not in conjunction with AMG high-performance ceramic composite braking system (code B07)	U70	-	●	○	○	525.00	630.00
Fuel tank – increased 75-litre capacity		915	○	○	-	-	87.50	105.00
Omission of AMG boot lid spoiler	Not in conjunction with AMG Exterior Carbon-Fibre package (code 773) or AMG Driver's package (code 250)	U46	-	-	○	○	no-cost option	
Reversing camera		218	○	●	○	○	220.83	265.00

[View offers](#)[Book a test drive](#) [AMG test drive](#)[Find a Retailer](#)[View the Range Guide](#)

Optional equipment

37

Item	Notes		AMG Sport	Mille Miglia 417 Edition	Mercedes-AMG SL 63	Mercedes-AMG SL 65	Basic RRP excl. VAT (£)	Total RRP incl. VAT (£)
Interior								
Analogue clock – in the centre of the dashboard		246	○	●	–	–	175.00	210.00
Ashtray and cigarette lighter	Replaces stowage compartment in centre console	301	○	○	○	○	41.67	50.00
Cup holders – in centre console, includes bottle holder in rear stowage compartment		309	○	●	○	○	62.50	75.00
Steering								
Steering wheel – multi-function AMG performance steering wheel in nappa leather/DINAMICA microfibre		281	–	–	○	○	350.00	420.00
Steering wheel – wood- and leather-trimmed steering wheel	Only in conjunction with light poplar, dark brown burr walnut or black ash wood trims (codes 729, 731 or 736). Replaces AMG performance steering wheel with silver-coloured aluminium gearshift paddles	289	–	–	○	○	541.67	650.00



Item	Notes					Basic RRP excl. VAT (£)	Total RRP incl. VAT (£)	
		AMG Sport	Mille Miglia 417 Edition	Mercedes-AMG SL 63	Mercedes-AMG SL 65			
Paint, Trim and Upholstery								
Paint – cerussite grey metallic (matt finish)		281	○	-	○	○	1,045.83	1,255.00
Paints – non-metallic		-	○	○	○	○	no-cost option	
Trim – black ash wood		736	○	○	-	-	287.50	345.00
			-	-	○	○	no-cost option	
Trim – dark brown burr walnut wood		731	-	-	○	○	no-cost option	
Trim – dark brushed aluminium	Not in conjunction with wood- and leather-trimmed steering wheel (code 289)	H76	-	-	○	○	no-cost option	
Trim – light brushed aluminium	Not in conjunction with wood- and leather-trimmed steering wheel (code 289)	739	●	-	○	○	no-cost option	
Trim – light poplar wood, satin finish		729	-	-	○	○	no-cost option	
Upholstery – Exclusive nappa leather	Includes roof lining in DINAMICA microfibre	-	-	-	○	●	2,116.67	2,540.00
Upholstery – nappa leather	Please note that nappa leather is not perforated, except in conjunction with comfort-ventilated seats (code 401)	-	○	●	-	-	591.67	710.00

[View offers](#)[Book a test drive](#) > [AMG test drive](#)[Find a Retailer](#)[View the Range Guide](#)

Optional equipment

39

Item	Notes		AMG Sport	Mille Miglia 417 Edition	Mercedes-AMG SL 63	Mercedes-AMG SL 65	Basic RRP excl. VAT (£)	Total RRP incl. VAT (£)
designo Paint, Trim and Upholstery								
designo metallic paint			○	-	○	○	1,862.50	2,235.00
Available in: mocha black 033 graphite 041								
designo diamond white metallic paint		799	○	-	○	○	575.00	690.00
			-	○	-	-	no-cost option	
designo hyacinth red metallic paint	Please check with your Retailer for availability	996	○	-	○	○	575.00	690.00
designo allanite grey magno paint		044	○	-	○	○	3,170.83	3,805.00
designo cashmere white magno paint		049	○	-	○	○	3,170.83	3,805.00
			-	○	-	-	no-cost option	
designo night black magno paint		056	-	○	-	-	no-cost option	



Item	Notes	AMG Sport	Mille Miglia 417 Edition	Mercedes-AMG SL 63	Mercedes-AMG SL 65	Basic RRP excl. VAT (£)	Total RRP incl. VAT (£)
designo Paint, Trim and Upholstery (continued)							
designo nappa leather upholstery	Based on black nappa leather (code 801). Only in conjunction with ambient lighting (code 877). Not in conjunction with ISOFIX child seat fixing points (code 572)	' -	-	○	-	2,541.67	3,050.00
Available in: sand X10 classic red X17 tuscan beige pearl X18 sienna brown X24 titanium grey pearl X26 platinum white X30 light brown X35 deep white X46							
designo Exclusive nappa leather upholstery	Based on black Exclusive nappa leather (code 501). Only in conjunction with ambient lighting (code 877). Not in conjunction with ISOFIX child seat fixing points (code 572)	' -	-	○	-	5,154.17	6,185.00
Available in: sand X10 classic red X17 tuscan beige pearl X18 sienna brown X24 titanium grey pearl X26 platinum white X30 light brown X35 deep white X46		-	-	-	○	3,037.50	3,645.00



Item	Notes	AMG Sport	Mille Miglia 417 Edition	Mercedes-AMG SL 63	Mercedes-AMG SL 65	Basic RRP excl. VAT (£)	Total RRP incl. VAT (£)
designo Paint, Trim and Upholstery (continued)							
designo roof lining in DINAMICA microfibre	Included in conjunction with Exclusive nappa leather for Mercedes-AMG SL 63	-	-	○	-	1,045.83	1,255.00
Available in: black Y41 ginger beige Y42 crystal grey Y44		-	-	-	○	no-cost option	
designo roof lining in leather		-	-	○	●	1,741.67	2,090.00
Available in: black Y73 ginger beige Y74 crystal grey Y75							
designo seat belts – silver		Y04	-	-	○	350.00	420.00
designo seat belts – red		Y05	-	●	○	350.00	420.00
designo wood trim		-	-	○	○	no-cost option	
Available in: natural bamboo W26 black piano lacquer W69 champagne white piano lacquer W70							



Item	Notes		AMG Sport	Mille Miglia 417 Edition	Mercedes-AMG SL 63	Mercedes-AMG SL 65	Basic RRP excl. VAT (£)	Total RRP incl. VAT (£)
Comfort								
Active Multi-Contour Seat package with massage function Inflatable air chambers allow the front seats to be individually adjusted - from seat cushion depth via the side bolsters to the position and curvature of the backrest. A lumbar adjustment gives added support to the spine. The massage function with seven zones and two selectable intensity settings helps to avoid muscle tension. Added comfort and safety is offered by the luxury head restraints		432	○	●	-	-	1,437.50	1,725.00
	Only in conjunction with comfort-ventilated seats (code 401)		-	-	○	○	604.17	725.00
Driving Assistance package Active Blind Spot Assist displays a red triangle in the exterior mirrors. When a road user is detected in the blind spot, the red triangle flashes and an audible warning sounds if the driver operates the indicators. Includes course-correcting braking intervention. Active Lane Keeping Assist detects signs of inadvertent drifting out of lane and warns the driver by vibrating the steering wheel and, if necessary, triggers one-sided braking intervention. DISTRONIC PLUS helps the driver to maintain a safe distance to the vehicle in front and so relieves the strain on the driver, especially on long journeys or in a traffic jam. BAS PLUS can lower the risk of rear-end collisions and support the driver during emergency braking by providing additional brake pressure. PRE-SAFE® Brake warns the driver if it detects that a rear-end collision is imminent and, if there is no reaction, can take autonomous action to reduce the speed - even to the extent of full brake application		23P	○	○	○	●	1,958.33	2,350.00



Item	Notes		AMG Sport	Mille Miglia 417 Edition	Mercedes-AMG SL 63	Mercedes-AMG SL 65	Basic RRP excl. VAT (£)	Total RRP incl. VAT (£)
Comfort (continued)								
KEYLESS-GO Comfort package Vehicle can be conveniently unlocked, started and locked, simply by carrying an electronic key. In addition, the convenient hands-free access function allows hands-off, fully automatic opening and closing of the boot lid by performing a kicking motion under the rear bumper – particularly useful when laden with luggage		P17	○	●	○	●	1,337.50	1,605.00
AIRSCARF – neck-level heating		403	○	●	○	●	479.17	575.00
Ambient lighting – choice of three colour settings		877	○	●	●	●	216.67	260.00
Closing aid for doors When initially engaged, the doors are automatically closed by servo motors, ensuring smooth and virtually silent closing		883	○	○	○	●	262.50	315.00
Comfort-ventilated seats	Supplied with perforated leather	401	○	●	○	●	620.83	745.00
Garage door opener – integrated in rear-view mirror For questions regarding compatibility please visit www.homelink.com		231	○	○	○	○	195.83	235.00
Panoramic vario-roof with MAGIC SKY CONTROL The panoramic roof changes from dark to transparent or vice versa within a few seconds. In its tinted state, it substantially reduces heating-up of the vehicle interior		412	○	●	○	○	1,562.50	1,875.00
Pre-installation for battery charger		675	-	-	○	○	87.50	105.00
Remote boot opening and closing	Included with KEYLESS-GO Comfort package (code P17)	881	○	●	○	●	458.33	550.00
Wind deflector – electrically operated		285	○	●	○	○	437.50	525.00



Item	Notes		AMG Sport	Mille Miglia 417 Edition	Mercedes-AMG SL 63	Mercedes-AMG SL 65	Basic RRP excl. VAT (£)	Total RRP incl. VAT (£)
Security and Safety								
Fire extinguisher		682	-	-	○	○	79.17	95.00
Night View Assist Plus Aids recognition of pedestrians or larger animals at night: they are clearly shown on the multi-function display		610	○	○	○	○	1,875.00	2,250.00
Communications and In-Car Entertainment								
SPLITVIEW for COMAND Online system with 6-disc changer	Allows different content to be displayed for driver and passenger	867	○	○	○	○	850.00	1,020.00
Surround sound system – Bang & Olufsen BeoSound AMG High-end sound system with 12 speakers and Frontbass, speaker covers in aluminium, two LED-illuminated tweeters featuring Acoustic Lens Technology, ICEpower amplifier 900 watt output		811	-	-	○	●	4,220.83	5,065.00
Surround sound system – Harman Kardon® Logic 7® with Dolby Digital 5.1 and DTS 10-channel DSP amplifier with 9 high-performance speakers and Frontbass, 600 watt output		810	○	●	○	-	958.33	1,150.00
Telephone pre-wiring with hands-free facility A separate cradle for your mobile phone needs to be ordered as an accessory from your Retailer	Works in conjunction with the multi-function steering wheel and display. The phone cradle is mounted in the front centre armrest. It is recommended that a compatible handset is sourced prior to ordering a cradle	386	○	○	○	●	341.67	410.00
TV tuner – digital reception capabilities		865	○	○	○	○	941.67	1,130.00



> View offers



Book a > test drive > AMG test drive



> Find a Retailer



> View the Range Guide

Optional equipment

45

Item	Notes		AMG Sport	Mille Miglia 417 Edition	Mercedes-AMG SL 63	Mercedes-AMG SL 65		Basic RRP excl. VAT (£)	Total RRP incl. VAT (£)
Service Package									
Service Care Service Care allows you to spread the cost of servicing your new car in the Mercedes-Benz Retailer network. Taking out a Service Care plan ensures your servicing needs are taken care of by fully trained Mercedes-Benz Technicians with the added benefit of a Mercedes-Benz service history	Price is based on a monthly rate. Example given is for two services taken over 24 months, three services over 36 months or four services over 48 months. Further payment options are available. New Service Care prices apply only to vehicles up to 12 months old prior to first service	1	○	○	-	-		34.16	41.00
			-	-	○	○		37.50	45.00



Genuine Accessories

We've developed a range of Accessories you can add to help personalise and enhance your SL. Your local Mercedes-Benz Retailer can advise on fitting costs of Accessories, where applicable. Further information on our selection of Genuine Accessories can be found on the Mercedes-Benz UK website.



01

01 | Shallow boot tub

The boot tub is suitable for transporting shopping. The tub shape with its slightly raised edge is precision-tailored to the load area. Made from impact-resistant, non-split polypropylene, its structured surface holds the separately available stowage crate in place.

Basic RRP £72.50 (excl. VAT) **Total RRP £87.00 (incl. VAT)**



02

02 | Illuminated door sill panels

High-quality, two-piece door sill panels made from brushed stainless steel. The white illuminated 'Mercedes-Benz' lettering is activated every time you open the door to get in or out. Set of 2.

Basic RRP £295.00 (excl. VAT) **Total RRP £354.00 (incl. VAT)**



03

03 | AMG Indoor Car Cover

Basic RRP £210.83 (excl. VAT) **Total RRP £253.00 (incl. VAT)**

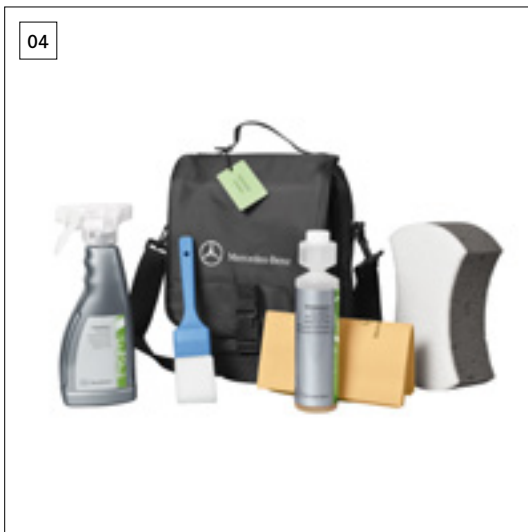

04 | Exterior Car Care Kit

The Mercedes-Benz Exterior Car Care Kit is a four-piece collection to keep the exterior of your car looking like it's come straight from the showroom. The bag contains car shampoo, wheel cleaner, sponge and polishing cloth.

Basic RRP £20.83 (excl. VAT) **Total RRP £25.00 (incl. VAT)**

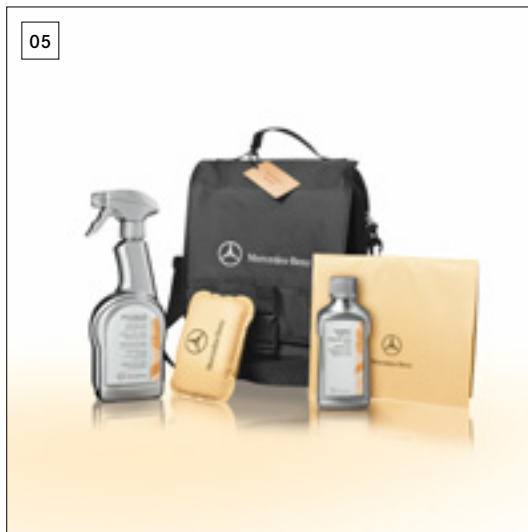

05 | Interior Car Care Kit

The Mercedes-Benz Interior Car Care Kit is a four-piece collection enabling you to maintain a spotless showroom finish inside your car. The bag contains cabin care spray, interior glass cleaner, interior glass sponge and car cloth.

Basic RRP £20.83 (excl. VAT) **Total RRP £25.00 (incl. VAT)**

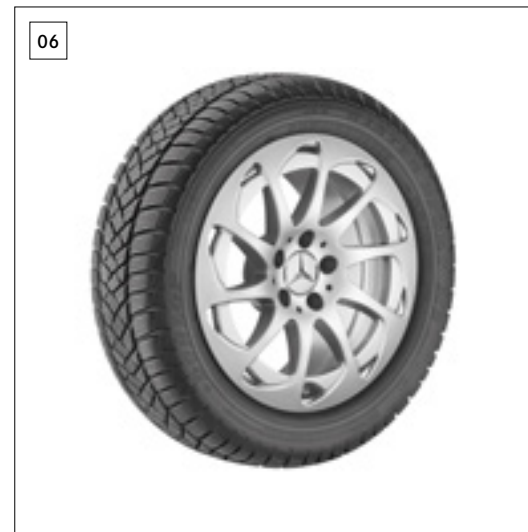

06 | Winter wheels and tyres

17" alloy wheels (4) – 10-spoke design.

Basic RRP £2,012.52 (excl. VAT)

Total RRP £2,415.03 (incl. VAT)



Colours and materials

Metallic paints (standard)

AMG Sport and Mercedes-AMG SL 63/65



183 magnetite black



197 obsidian black



526 dolomite brown



775 iridium silver



890 cavansite blue

Non-metallic paints (no-cost option)

AMG Sport and Mercedes-AMG SL 63/65

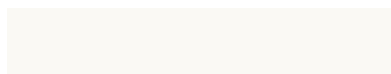

149 polar white



590 fire opal

Metallic paints (standard)

SL Mille Miglia 417 Edition



183 magnetite black

designo paints (no-cost option)

SL Mille Miglia 417 Edition only



056 designo magno night black

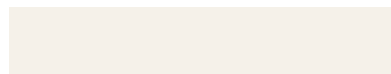

049 designo magno cashmere white

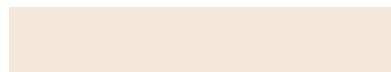

799 designo diamond white

Special paints (additional-cost option)

AMG Sport and Mercedes-AMG SL 63/65



033 designo mocha black



041 designo graphite



044 designo magno allanite grey

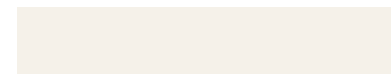

049 designo magno cashmere white



281 cerussite grey metallic (matt finish)

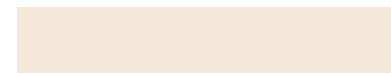

799 designo diamond white



996 designo hyacinth red¹

¹Please check with your Retailer for availability

Please note that, owing to limitations of the printing process, paint colours may differ from those shown



SL 400 and SL 500 AMG Sport upholstery

Leather¹

Nappa leather²



211 black



807 bengal red



815 porcelain

SL 400 and SL 500 AMG Sport trim



739 light brushed aluminium¹



736 black ash wood, high-gloss²

SL Mille Miglia 417 Edition upholstery

Nappa leather¹



861 black with highlights and piping in classic red

SL Mille Miglia 417 Edition trim



H77 AMG matt black carbon fibre trim¹

Mercedes-AMG SL 63 and Mercedes-AMG SL 65 upholstery

Nappa leather³

Exclusive nappa leather^{4,5}



801 black



501 black

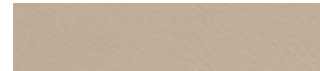

805 ginger beige/espresso brown



505 ginger beige/espresso brown



807 bengal red



507 bengal red



815 porcelain



515 porcelain

Mercedes-AMG SL 63 and Mercedes-AMG SL 65 trim



H73 AMG carbon fibre¹



731 dark brown burr walnut wood⁶



H76 dark brushed aluminium⁷



736 black ash wood⁶



729 light poplar wood, satin finish⁷



739 light brushed aluminium⁷

¹Standard ²Optional ³Standard on Mercedes-AMG SL 63 ⁴Standard on Mercedes-AMG SL 65 ⁵Optional on Mercedes-AMG SL 63 ⁶High-gloss; no-cost option ⁷No-cost option



Trim and upholstery combinations

	AMG Sport	SL Mille Miglia 417 Edition	Mercedes-AMG SL 63/optional AMG Sport				Mercedes-AMG SL 65/optional Mercedes-AMG SL 63			
	Leather	Nappa leather	Nappa leather				Exclusive nappa leather			
	black (211)	black with highlights and piping in classic red (861)	black (801) ¹	ginger beige/espresso brown (805) ¹	bengal red (807)	porcelain (815)	black (501)	ginger beige/espresso brown (505)	bengal red (507)	porcelain (515)
Dashboard										
Steering wheel	black	black	black	espresso brown	black	black	black	espresso brown	black	black
Upper dashboard trim	black	black	black	espresso brown	black	black	black	espresso brown	black	black
Lower dashboard trim	black	black	black	beige	bengal red	porcelain	black	black	bengal red	porcelain
Seats										
Seat cushion centre section	black	black/red	black	beige	bengal red	porcelain	black	espresso brown	black	black
Side bolster trim	black	black/red	black	beige	bengal red	porcelain	black	espresso brown	black	black
Head restraint	black	black/red	black	beige	bengal red	porcelain	black	beige	bengal red	porcelain
Doors										
Door centre panel	black	black/red	black	beige	bengal red	porcelain	black	beige	bengal red	porcelain
Door trim at beltline	black	black	black	espresso brown	black	black	black	espresso brown	black	black
Roof lining	black	black	crystal grey	beige	black	black	crystal grey	beige	black	black
Parcel shelf	black	black	black	espresso brown	black	black	black	espresso brown	black	black
Floor covering										
Front and rear	black	black	black	beige	black	black	black	beige	black	black
Boot	black	black	black	black	black	black	black	black	black	black

¹Not available for SL 400 and SL 500 Please note that, owing to limitations of the printing process, paint colours may differ from those shown



Combination options

Leather/nappa leather/Exclusive nappa leather		Metallic paints Standard						Non-metallic paints No-cost option		Special metallic paints Additional-cost option						
		183 magnetite black ¹	197 obsidian black	281 cerussite grey (matt finish) ²	526 dolomite brown	775 iridium silver	890 cavansite blue	149 polar white	590 fire opal	033 designo mocha black	041 designo graphite	044 designo magno allanite grey	049 designo magno cashmere white ¹	056 designo magno night black ¹	799 designo diamond white	996 designo hyacinth red ³
	black	●	●	●	●	●	●	●	●	●	●	●	●	●	●	●
	ginger beige/espresso brown	●	●	△	●	△	●	●	●	●	△	△	●	●	●	●
	bengal red	●	●	●	△	●	○	●	△	○	○	●	●	●	●	●
	porcelain	●	●	●	●	△	●	●	●	●	●	○	●	●	●	●



Technical data

		Petrol engines			
Model		SL 400 AMG Sport	SL 500 AMG Sport	Mercedes-AMG SL 63	Mercedes-AMG SL 65
Engine					
Total displacement	cc	2,996	4,663	5,461	5,980
Arrangement/cylinders/valves		V/6/24	V/8/32	V/8/32	V/12/36
Power ¹	hp (kW) at rpm	333 (245)/5,250-6,000	455 (335)/5,250	585 (430)/5,500	630 (463)/4,800
Torque ¹	Nm at rpm	480/1,600-4,000	700/1,800-3,500	900/2,250-3,750	1,000/2,300-4,300
Compression ratio		10.5:1	10.5:1	10.0:1	9.0:1
Transmission					
7G-TRONIC PLUS 7-speed automatic		●	●	-	-
AMG SPEEDSHIFT MCT 7-speed automatic		-	-	●	-
AMG SPEEDSHIFT PLUS 7G-TRONIC auto.		-	-	-	●
Tyres sizes					
Front		255/35 R 19	255/35 R 19	255/35 R 19	255/35 R 19
Rear		285/30 R 19	285/30 R 19	285/30 R 19	285/30 R 19



Model	Petrol engines			
	SL 400 AMG Sport	SL 500 AMG Sport	Mercedes-AMG SL 63	Mercedes-AMG SL 65

Performance

Acceleration 0–62 mph	sec	5.2	4.6	4.2	4.0
Top speed	mph	155 ²	155 ²	155 ² (186 ³)	155 ² (186 ³)

Weights and capacities

Kerb weight	kg	1,730	1,785	1,845	1,950
Perm. Gross Vehicle Weight	kg	2,110	2,165	2,180	2,210
Boot capacity with roof closed	l	504	504	504	504
with roof open		364	364	364	364
Fuel tank capacity/of which reserve	l	65/8	65/8	75/14	75/14
Turning circle	m	11.04	11.04	11.10	11.10

Fuel consumption^{4,5}

mpg

Urban	27.7	22.2	20.2	16.6
Extra-urban ⁶	45.6	40.4	37.7	33.6
Combined	36.7	31.0	28.8	24.4



Model	Petrol engines			
	SL 400 AMG Sport	SL 500 AMG Sport	Mercedes-AMG SL 63	Mercedes-AMG SL 65
CO₂ emissions⁵	g/km			
Emissions standard	EU6	EU6	EU6	EU6
19" alloy wheels (285/30 tyres)	179	212	234	279
20" alloy wheels (285/30 tyres)	-	-	234	279
Insurance				
Group rating	50A	50A	50A	50A

Insurance ratings may vary depending on model line and specification. Please refer to <http://www.thatcham.org/abigrouprating/> for further details

¹Figures according to Directive 80/1269/EEC in the currently applicable version

²Electronically limited

³In conjunction with optional AMG Driver's Package (code 250 for Mercedes-AMG SL 63 and Mercedes-AMG SL 65)

⁴All figures are based on a standard specification with the smallest tyre size

⁵The choice of wheels may affect CO₂ emissions and corresponding Road Fund Licence

⁶EUDC: extra-urban driving cycle. Testing procedures adhere to EU Directive 93/116

The figures on pages 52-55 are correct at time of going to print. Please refer to the government website for latest data - <http://carfueldata.direct.gov.uk/>



> View offers



Book a > test drive > AMG test drive



> Find a Retailer



> View the Range Guide

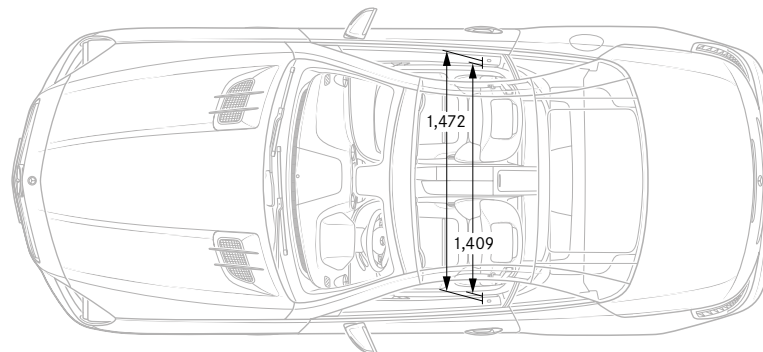
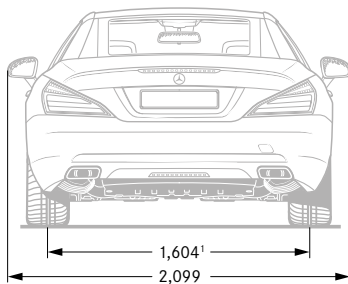
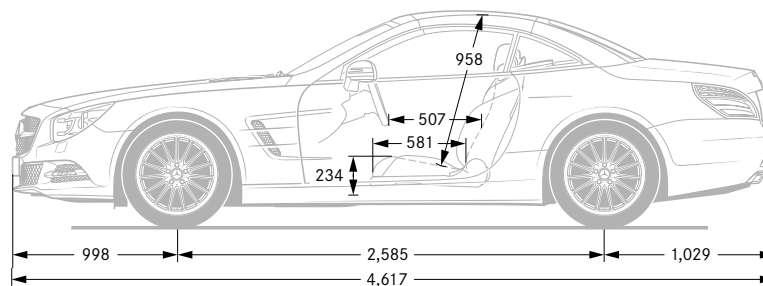
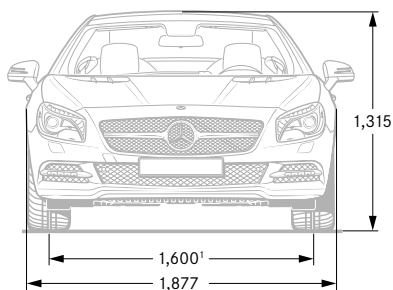

¹ Carrying two people, each weighing 68 kg

All measurements in millimetres. The dimensions shown are mean values and apply to standard-specification, unladen vehicles. Illustrations may differ from current specification



Road Fund Licence



All road vehicle registrations are subject to Vehicle Excise Duty (Road Fund Licence), which varies in accordance with the vehicle's CO₂ emissions. A first year rate of Vehicle Excise Duty applies to new cars on their first year of registration. For the second and subsequent years a standard rate for each taxation band will apply.¹ The table below shows the bands (A–M) created by the DVLA and the corresponding Road Fund Licence. CO₂ emissions are listed in the technical data on page 54, and the relevant Excise Duty is reflected in the on-the-road prices on page 11.

Band	CO ₂ emissions	First year rate (£)	Standard rate (£)
A	up to 100 g/km	0.00	0.00
B	101 to 110 g/km	0.00	20.00
C	111 to 120 g/km	0.00	30.00
D	121 to 130 g/km	0.00	110.00
E	131 to 140 g/km	130.00	130.00
F	141 to 150 g/km	145.00	145.00
G	151 to 165 g/km	180.00	180.00
H	166 to 175 g/km	295.00	205.00
I	176 to 185 g/km	350.00	225.00
J	186 to 200 g/km	490.00	265.00
K	201 to 225 g/km	640.00	290.00
L	226 to 255 g/km	870.00	490.00
M	over 255 g/km	1,100.00	505.00

¹For further information on vehicle taxation please refer to <https://carfueldata.direct.gov.uk/>

Services and insurance

Mercedes-Benz Service Care

We believe that servicing costs should be as flexible and affordable as possible for your S-Class, which is why we offer Service Care, an easy way to budget for all your servicing costs. It spreads your bills into manageable payments based on whether you have a new or used Mercedes-Benz.

With Service Care we guarantee the price of parts and labour for up to four services and safeguard against further inflation. It also covers the cost of all recommended service items including brake fluid, spark plugs, air filters, fuel filters and screen wash.

You can choose either to add your servicing costs into your monthly spend or pay the full amount in a one-off payment, giving you peace of mind that they are taken care of for the period of the plan.

To receive a personalised Service Care plan recommendation visit the Service Care Calculator at www.mercedes-benz.co.uk/servicecare

Warranty and breakdown cover

Every Mercedes-Benz comes with a three-year unlimited mileage warranty against manufacturing or material defects¹ and up to 30 years warranty against perforation due to corrosion from the inside out.² What's more, it's also covered by Mercedes-Benz Roadside Assistance – a unique package comprising up to 30 years pan-European breakdown assistance.²

Insurance

Since our name is synonymous with reliability, who better to trust with your motor insurance? Mercedes-Benz Insurance provides a motor insurance policy specifically designed to give you the cover you would expect from Mercedes-Benz. For a motor insurance quotation, call **0345 600 2180**.*



Mercedes-Benz Finance

Why should you finance with Mercedes-Benz?

At Mercedes-Benz we believe a great driving experience should be matched by an equally great ownership experience. That is why we put just as much thought, time and effort into designing our finance options, our service plans and our insurance cover as we do into our vehicles.

We are not in the business of simply providing a loan to fund the purchase of your dream vehicle. We look on it as a journey that we take with you, from the moment you choose your new Mercedes-Benz, to helping you in choosing your next one.

If you would like to find out more about any of our current offers, simply call into your local Mercedes-Benz Retailer where one of our Business Managers will be more than happy to talk you through anything you need to know.

Helping you find the right solution.

You should find our finance packages are more convenient than a traditional personal loan because:

- Funds are immediately available – no waiting for cheques or loans to clear.
- There is no security required – either against your home or other assets.
- We have clear and transparent rates – the APR we quote is the APR you get.
- We have friendly Business Managers – experts in vehicle finance who can talk you through all of your plans in detail.

One of our most popular finance products is Mercedes-Benz Agility (our Personal Contract Purchase product). We also offer Contract Hire, Operating Lease and Hire Purchase solutions. If you would like to find out more about these speak to your Retailer or visit www.mercedes-benz.co.uk/fandi.

Mercedes-Benz Agility (our PCP product).

At the start of an Agility agreement, you put down a deposit and decide the term of your agreement and your annual mileage. You will be advised of the Guaranteed Future Value, which offers you the reassurance of knowing exactly what you will need to pay to own the vehicle outright in the future (this is known as the Optional Purchase Payment).

Throughout your agreement you simply pay your agreed monthly payments and when the agreement comes to an end you either purchase, hand back or part-exchange your vehicle.





Agility features:

- Fixed regular payments mean you can easily budget.
- Payments are based only on a proportion of the vehicle's value, keeping your monthly payments lower.
- Our Guaranteed Future Value avoids the risk of unplanned depreciation of your vehicle.
- You defer your ownership decision until the end of the agreement.

At the end of your agreement you have three options to choose from.

Option 1: Purchase your Mercedes-Benz.

Purchase your Mercedes-Benz by paying the Optional Purchase Payment and Purchase Activation Fee.¹ This will complete the purchase of your Mercedes-Benz, leaving you free to simply enjoy your vehicle.

Option 2: Hand back your Mercedes-Benz.

If you decide to return your vehicle to us, it must be in line with our Vehicle Return Standards,* as vehicle condition, excess mileage and other charges may be payable.

Option 3: Part-Exchange for a new vehicle.

Purchase your Mercedes-Benz by paying the Optional Purchase Payment and Purchase Activation Fee.¹ This will complete the purchase of your Mercedes-Benz, leaving you free to part-exchange for a new vehicle.

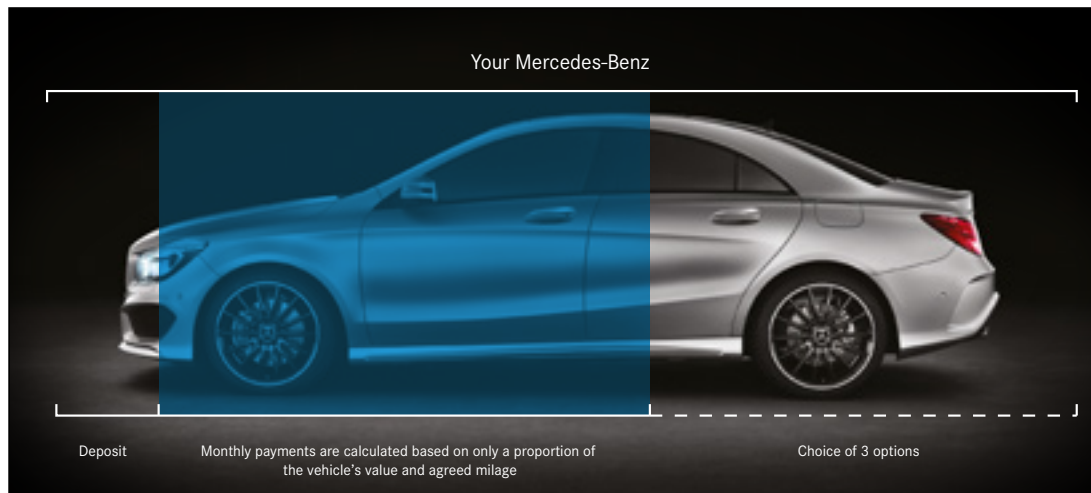

¹Please note the 'Purchase Activation Fee' of £10 will be debited from your account *To find out more information about our Vehicle Return Standards please visit <http://mercedes-benz.co.uk/vrs>



> View offers



Book a > test drive > AMG test drive



> Find a Retailer



> View the Range Guide

Follow us on the following social media channels:



<https://www.facebook.com/MercedesBenzUk>



<https://twitter.com/mercedesbenzuk>



<https://www.youtube.com/mercedesbenzuk>



<https://instagram.com/mercedesbenzuk>

Effective from 1 September 2015. Information correct at time of going to print.

Prices and specifications are subject to change without prior notice.

MBR231PL/0915 MY 806 Production from 01.06.2015

Mercedes-Benz UK Ltd, Tongwell, Milton Keynes, MK15 8BA www.mercedes-benz.co.uk



Mixed Sources

Product group from well-managed forests, controlled sources and recycled wood or fibre
www.fsc.org Cert no. SGS-COC-004556
©1996 Forest Stewardship Council

