



[View offers](#)



[Book a test drive](#) [AMG test drive](#)



[Find a Retailer](#)



[View the Range Guide](#)

A-Class



Effective from 14 April 2016.

Mercedes-Benz





> View offers



Book a > test drive > AMG test drive



> Find a Retailer



> View the Range Guide

Contents

Model prices	8	Pricing summary for model and equipment lines	33	Genuine Accessories	55
Finance offers	11	Standard equipment	35	Colours and materials	59
SE, Sport, AMG Line, Motorsport Edition and 250 AMG	15	Wheels	42	Technical data	63
Executive, Premium and Premium Plus equipment lines	25	Exclusive and AMG Exclusive packages	46	Road Fund Licence	67
Mercedes-AMG model	28	Night and AMG Night packages	48	Services and insurance	68
Premium equipment line for Mercedes-AMG models	30	Lane Tracking package and Driving Assistance package	50	Mercedes me	69
Mercedes-AMG driver training	31	Optional equipment	51	Mercedes-Benz Finance	71



> View offers



Book a > test drive > AMG test drive



> Find a Retailer



> View the Range Guide

The hard facts to melt your heart

At Mercedes-Benz we appreciate the importance of detail. Over the following pages you'll find model prices and a breakdown of standard and optional equipment, as well as details of the comprehensive services and benefits that are available to every Mercedes-Benz driver.

See Mercedes-Benz in a new light. Now is the time to get yourself behind the wheel of an A-Class. Choose from a number of attractive finance offers. Please see pages 11-14 for further details, or visit www.mercedes-benz.co.uk/offers

Of course, some things have to be experienced to be truly appreciated, such as the qualities that set a Mercedes-Benz apart. Which is why we'd like to invite you for a test drive at your local Mercedes-Benz Retailer. Alternatively, you can make arrangements by visiting www.mercedes-benz.co.uk/testdrive

For more information visit www.mercedes-benz.co.uk or call 0333 222 0500.



View offers



Book a test drive AMG test drive



Find a Retailer



View the Range Guide





> View offers



Book a > test drive > AMG test drive



> Find a Retailer



> View the Range Guide





[View offers](#)



[Book a test drive](#) [AMG test drive](#)



[Find a Retailer](#)



[View the Range Guide](#)





[View offers](#)



[Book a test drive](#) [AMG test drive](#)



[Find a Retailer](#)



[View the Range Guide](#)



Model prices

Engine	Model line	Transmission	CO ₂	Basic RRP excl. VAT (£)	Total RRP incl. VAT (£)	Road Fund Licence (£) ¹	Rec. OTR price (£) ²	P11D value (£)	BiK tax rate 2016/17 (%)
A 180 d Diesel – 1,461 cc, 4-cylinder, 109 hp/80 kW	SE	6-speed manual	89	18,179.17	21,815.00	0.00	22,485.00	22,430.00	18
		7G-DCT 7-speed automatic ³	98	19,429.17	23,315.00	0.00	23,985.00	23,930.00	19
	Sport	6-speed manual	102	19,008.33	22,810.00	0.00	23,480.00	23,425.00	20
		7G-DCT 7-speed automatic ³	101	20,258.33	24,310.00	0.00	24,980.00	24,925.00	20
	AMG Line	6-speed manual	102	20,087.50	24,105.00	0.00	24,775.00	24,720.00	20
		7G-DCT 7-speed automatic ³	101	21,337.50	25,605.00	0.00	26,275.00	26,220.00	20
A 200 d Diesel – 2,143 cc, 4-cylinder, 136 hp/100 kW	SE	6-speed manual	106	19,075.00	22,890.00	0.00	23,560.00	23,505.00	21
		7G-DCT 7-speed automatic ³	99	20,325.00	24,390.00	0.00	25,060.00	25,005.00	19
	Sport	6-speed manual	111	19,904.17	23,885.00	0.00	24,555.00	24,500.00	22
		7G-DCT 7-speed automatic ³	103	21,154.17	25,385.00	0.00	26,055.00	26,000.00	20
	AMG Line	6-speed manual	111	20,983.33	25,180.00	0.00	25,850.00	25,795.00	22
		7G-DCT 7-speed automatic ³	103	22,233.33	26,680.00	0.00	27,350.00	27,295.00	20
A 220 d Diesel – 2,143 cc, 4-cylinder, 177 hp/130 kW	AMG Line	7G-DCT 7-speed automatic ³	107	23,425.00	28,110.00	0.00	28,780.00	28,725.00	21
	Motorsport Edition	7G-DCT 7-speed automatic ³	107	26,133.33	31,360.00	0.00	32,030.00	31,975.00	21
A 220 d 4MATIC Diesel – 2,143 cc, 4-cylinder, 177 hp/130 kW	AMG Line	7G-DCT 7-speed automatic ³	124	24,675.00	29,610.00	0.00	30,280.00	30,225.00	24
	Motorsport Edition	7G-DCT 7-speed automatic ³	124	27,383.33	32,860.00	0.00	33,530.00	33,475.00	24

¹ A different first year rate of Vehicle Excise Duty (Road Fund Licence) applies for new cars. Please refer to page 67 for the relevant rate for the second and subsequent years

² Recommended on-the-road price: these prices reflect the Road Fund Licence applicable to the standard model plus £670.00 additional costs necessary to put your car on the road. Included are a standard UK delivery charge (£540.00 incl. VAT), new vehicle registration fee (£55.00), number plates (£25.00 incl. VAT) and fuel (£50.00 incl. VAT). VAT is calculated at the standard rate of 20% ³With SPEEDTRONIC cruise control as standard



Engine	Model line	Transmission	CO ₂	Basic RRP excl. VAT (£)	Total RRP incl. VAT (£)	Road Fund Licence (£) ¹	Rec. OTR price (£) ²	P11D value (£)	BiK tax rate 2016/17 (%)
A 160 Petrol – 1,595 cc, 4-cylinder, 102 hp/75 kW	SE	6-speed manual	124	16,100.00	19,320.00	0.00	19,990.00	19,935.00	21
		7G-DCT 7-speed automatic ³	119	17,350.00	20,820.00	0.00	21,490.00	21,435.00	20
	Sport	6-speed manual	126	16,929.17	20,315.00	0.00	20,985.00	20,930.00	22
		7G-DCT 7-speed automatic ³	124	18,179.17	21,815.00	0.00	22,485.00	22,430.00	21
	AMG Line	6-speed manual	126	18,008.33	21,610.00	0.00	22,280.00	22,225.00	22
		7G-DCT 7-speed automatic ³	124	19,258.33	23,110.00	0.00	23,780.00	23,725.00	21
A 180 Petrol – 1,595 cc, 4-cylinder, 122 hp/90 kW	SE	6-speed manual	127	17,283.33	20,740.00	0.00	21,410.00	21,355.00	22
		7G-DCT 7-speed automatic ³	121	18,533.33	22,240.00	0.00	22,910.00	22,855.00	21
	Sport	6-speed manual	131	18,112.50	21,735.00	130.00	22,535.00	22,350.00	23
		7G-DCT 7-speed automatic ³	126	19,362.50	23,235.00	0.00	23,905.00	23,850.00	22
	AMG Line	6-speed manual	131	19,191.67	23,030.00	130.00	23,830.00	23,645.00	23
		7G-DCT 7-speed automatic ³	126	20,441.67	24,530.00	0.00	25,200.00	25,145.00	22
A 200 Petrol – 1,595 cc, 4-cylinder, 156 hp/115 kW	Sport	6-speed manual	132	19,383.33	23,260.00	130.00	24,060.00	23,875.00	23
		7G-DCT 7-speed automatic ³	126	20,633.33	24,760.00	0.00	25,430.00	25,375.00	22
	AMG Line	6-speed manual	132	20,462.50	24,555.00	130.00	25,355.00	25,170.00	23
		7G-DCT 7-speed automatic ³	126	21,712.50	26,055.00	0.00	26,725.00	26,670.00	22

¹A different first year rate of Vehicle Excise Duty (Road Fund Licence) applies for new cars. Please refer to page 67 for the relevant rate for the second and subsequent years

²Recommended on-the-road price: these prices reflect the Road Fund Licence applicable to the standard model plus £670.00 additional costs necessary to put your car on the road. Included are a standard UK delivery charge (£540.00 incl. VAT), new vehicle registration fee (£55.00), number plates (£25.00 incl. VAT) and fuel (£50.00 incl. VAT). VAT is calculated at the standard rate of 20% ³With SPEEDTRONIC cruise control as standard

[View offers](#)[Book a test drive](#) > [AMG test drive](#)[Find a Retailer](#)[View the Range Guide](#)

Model prices

10

Engine	Model line	Transmission	CO ₂	Basic RRP excl. VAT (£)	Total RRP incl. VAT (£)	Road Fund Licence (£) ¹	Rec. OTR price (£) ²	P11D value (£)	BiK tax rate 2016/17 (%)
A 250 Petrol – 1,991 cc, 4-cylinder, 218 hp/160 kW	250 AMG	6-speed manual	158	23,741.67	28,490.00	185.00	29,345.00	29,105.00	28
		7G-DCT 7-speed automatic ³	145	24,991.67	29,990.00	145.00	30,805.00	30,605.00	26
A 250 4MATIC Petrol – 1,991 cc, 4-cylinder, 218 hp/160 kW	250 AMG	7G-DCT 7-speed automatic ³	156	26,241.67	31,490.00	185.00	32,345.00	32,105.00	28
Mercedes-AMG									
Mercedes-AMG A 45 4MATIC Petrol – 1,991 cc, 4-cylinder, 381 hp/280 kW	–	AMG SPEEDSHIFT DCT 7-speed sports automatic ³	162	33,200.00	39,840.00	185.00	40,695.00	40,455.00	29

¹A different first year rate of Vehicle Excise Duty (Road Fund Licence) applies for new cars. Please refer to page 67 for the relevant rate for the second and subsequent years

²Recommended on-the-road price: these prices reflect the Road Fund Licence applicable to the standard model plus £670.00 additional costs necessary to put your car on the road. Included are a standard UK delivery charge (£540.00 incl. VAT), new vehicle registration fee (£55.00), number plates (£25.00 incl. VAT) and fuel (£50.00 incl. VAT). VAT is calculated at the standard rate of 20% ³With SPEEDTRONIC cruise control as standard



Mercedes-Benz Finance

Where the clever money goes

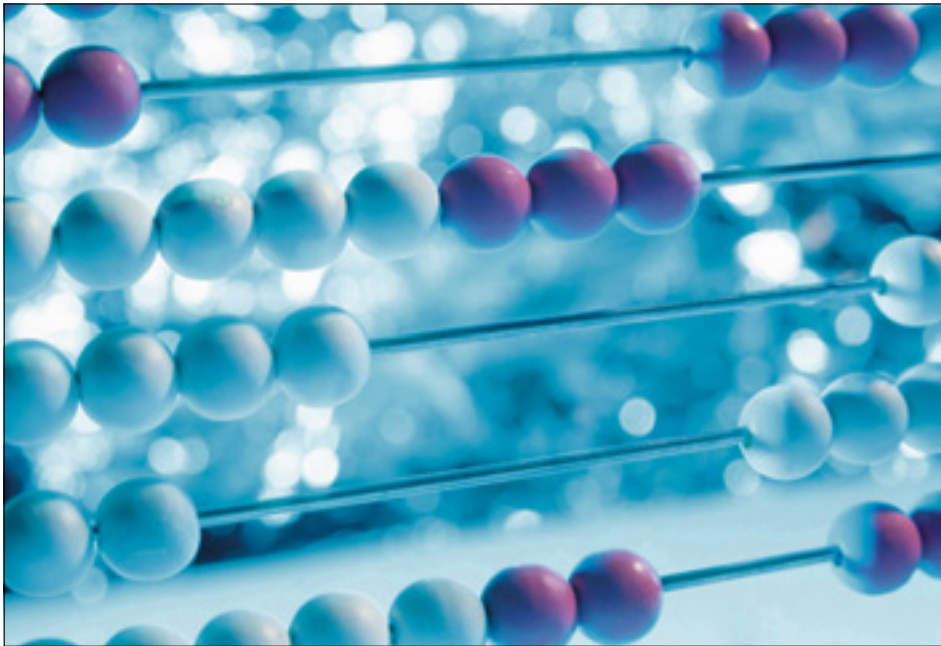

A 180 Sport (representative example)

36 monthly payments of ¹	£279.00
Customer deposit	£2,999.00
On-the-road price	£22,190.00
Retailer deposit contribution	£443.43
Optional purchase payment ²	£11,125.00
Amount of credit	£18,747.57
Duration of agreement	36 months
Total amount payable ³	£24,621.43
Purchase activation fee ²	£10.00
APR	5.5%
Fixed interest rate	5.33%
Excess mileage	6p per mile

**Example offers –
5.5% APR Representative**

	Automatic	Metallic	On-the-road price	Retailer deposit contribution	Customer deposit	36 monthly payments of ¹
A 180 SE	–	–	£21,065.00	£443.43	£2,866.72	£269.00
A 220 d AMG Line	●	–	£28,385.00	£443.43	£3,392.53	£369.00
A 250 AMG	–	○	£29,575.00	£443.43	£3,696.37	£379.00

● Standard equipment ○ Optional equipment included in the price

Mercedes-Benz Service Care

- Mercedes-Benz trained Technicians
- Maintained by Mercedes-Benz Retailers
- Meets requirements of Mercedes-Benz Agility finance agreement

Mercedes-Benz Motor Insurance

- 24/7 UK accident recovery
- We use Mercedes-Benz GenuineParts
- To qualify for up to 10% discount online, go to www.mercedes-benz.co.uk/motorinsurance
- Alternatively, call Mercedes-Benz Motor Insurance now on **0345 600 2180⁴** for an annual quote

We may decline to quote in some circumstances. Mercedes-Benz Motor Insurance is underwritten by Aviva Insurance Limited

Content relating to finance is promoted by Mercedes-Benz Finance. Your Retailer may offer finance on behalf of other companies.

Orders/credit approvals on selected A-Class models only, between 1 April and 30 June 2016, registered by 30 September 2016; excluding Mercedes-AMG A 45 models. Some combinations of features/options may not be available.

Please contact your local Mercedes-Benz Retailer for availability

¹Based on a Mercedes-Benz Agility agreement. Vehicle condition, excess mileage and other charges may be payable. Quotations available on request for alternative contract lengths and mileages.

Guarantees may be required. Credit provided, subject to status, by Mercedes-Benz Finance, MK15 8BA

²Payable if you exercise the option to purchase the car

³Includes optional purchase payment, purchase activation fee and Retailer deposit contribution (where applicable)

⁴Calls are charged at local rate and may be recorded



> View offers



Book a > test drive > AMG test drive



> Find a Retailer



> View the Range Guide

Mercedes-Benz Finance

Even the finance offer is beautifully put together



Mercedes-AMG A 45 4MATIC with automatic transmission and optional metallic paint (representative example)

36 monthly payments of ¹	£499.00
Customer deposit	£6,587.55
On-the-road price	£40,575.00
Optional purchase payment ²	£21,025.00
Amount of credit	£33,987.45
Duration of agreement	36 months
Total amount payable ³	£45,586.45
Purchase activation fee ²	£10.00
APR	6.2%
Fixed interest rate	5.98%
Excess mileage	9p per mile



Example offers – 6.2% APR Representative

	Automatic	Metallic	On-the-road price	Customer deposit	36 monthly payments of ¹
Mercedes-AMG A 45 4MATIC	●	○	£40,575.00	£6,587.55	£499.00

● Standard equipment ○ Optional equipment included in the price

Mercedes-Benz Service Care

- Mercedes-Benz trained Technicians
- Maintained by Mercedes-Benz Retailers
- Meets requirements of Mercedes-Benz Agility finance agreement

Mercedes-Benz Motor Insurance

- 24/7 UK accident recovery
- We use Mercedes-Benz GenuineParts
- To qualify for up to 10% discount online, go to www.mercedes-benz.co.uk/motorinsurance
- Alternatively, call Mercedes-Benz Motor Insurance now on **0345 600 2180⁴** for an annual quote

We may decline to quote in some circumstances. Mercedes-Benz Motor Insurance is underwritten by Aviva Insurance Limited

Content relating to finance is promoted by Mercedes-Benz Finance. Your Retailer may offer finance on behalf of other companies.

Orders/credit approvals on AMG A 45 models only, between 1 April and 30 June 2016, registered by 30 September 2016; excluding non-Mercedes-AMG models. Some combinations of features/options may not be available. Please contact your local Mercedes-Benz Retailer for availability

¹Based on a Mercedes-Benz Agility agreement. Vehicle condition, excess mileage and other charges may be payable. Quotations available on request for alternative contract lengths and mileages.

Guarantees may be required. Credit provided, subject to status, by Mercedes-Benz Finance, MK15 8BA

²Payable if you exercise the option to purchase the car

³Includes optional purchase payment, purchase activation fee and Retailer deposit contribution (where applicable)

⁴Calls are charged at local rate and may be recorded



> View offers



Book a > test drive > AMG test drive



> Find a Retailer



> View the Range Guide

A-Class SE



ARTICO leather¹ seats in black



Optional metallic paint shown





> View offers



Book a > test drive > AMG test drive



> Find a Retailer



> View the Range Guide

The A-Class SE with 16" alloy wheels in a 5-twin spoke design, beltline strips in chrome optic and a single-louvre grille in body colour makes a strong impression with new styling features inside and out. The interior of the SE features ARTICO leather¹ upholstery for the seats with extendable seat

cushions. Advanced hi-tech also comes courtesy of the reversing camera with dynamic guidelines presented on the 7-inch Media Display, and in-car entertainment including Audio 20 CD multimedia system with pre-installation for Garmin[®] MAP PILOT navigation system.

Exterior

- 16" alloy wheels – 5-twin spoke design, painted in black with high-shen finish
- Beltline strips in chrome look
- Chrome-plated trim strip in front apron
- Comfort suspension (lowered comfort suspension on A 180 d SE manual)
- Diamond radiator grille in black and single louvre painted in vehicle colour with chrome insert
- Halogen headlamps including integral daytime running lights

Interior

- Storage package
 - Sunglasses compartment in overhead control panel, storage boxes underneath front seats, storage nets behind front seats and in passenger footwell
- 7-inch Media Display
- Active Brake Assist
- ARTICO leather¹ seats
- Audio 20 CD multimedia system including pre-installation for Garmin[®] MAP PILOT navigation system

- Cruise Control with Limiter
- Reversing camera with dynamic guidelines on the Media Display
- Smartphone integration comprising Apple CarPlay™ and Android Auto
- Steering wheel – 12-button multi-function leather steering wheel, 3-spoke design with black topstitching
- THERMATIC – air conditioning

Trim and Upholstery

Honeycomb



ARTICO leather¹ in black



ARTICO leather¹ in crystal grey

¹Man-made leather



> View offers



Book a > test drive > AMG test drive



> Find a Retailer



> View the Range Guide

A-Class Sport



ARTICO leather¹ seats in black



Optional metallic paint shown





True to its name, the Sport model is equipped with chrome trim parts, a single louvre grille in silver, visible twin tailpipes in polished stainless steel and 17" 5-twin-spoke alloy wheels. It features new technology like the handling programme DYNAMIC SELECT, which allows you to adjust transmission

modes to suit road conditions and your driving style. The interior stands out with either black or crystal grey ARTICO leather¹ seats, combined with a chequerboard trim. THERMOTRONIC luxury automatic climate control and an 8-inch Media Display come as standard.

In addition/replacement to SE:

Exterior

17" alloy wheels – 5-twin-spoke design

Diamond radiator grille in black and single louvre in silver with chrome insert

DYNAMIC SELECT – with a choice of driving modes: ECO, Comfort, Sport and Individual

Illuminated door sills

Rain-sensing windscreen wipers

Twin tailpipes in polished stainless steel

Interior

8-inch Media Display

Chequerboard trim

Illumination for stowage compartment and vanity mirrors; reading lights and console light in rear roof lining

Steering wheel – 12-button multi-function leather steering wheel, 3-spoke design with perforated grip area and black topstitching

THERMOTRONIC – luxury automatic climate control

Trim and Upholstery

Black chequerboard



ARTICO leather¹ in black



Grey chequerboard



ARTICO leather¹ in crystal grey

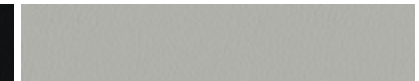

¹Man-made leather



> View offers



Book a > test drive > AMG test drive



> Find a Retailer



> View the Range Guide

A-Class AMG Line



ARTICO leather¹/DINAMICA microfibre sports seats with contrast stitching



Optional metallic paint shown





For a powerful look, the AMG Line comes with AMG bodystyling a diamond radiator grille with pins in chrome and a silver louvre with chrome insert. The striking titanium grey 18" AMG alloy wheels in a 5-twin-spoke design are set against front brake calipers with 'Mercedes-Benz' lettering. For a truly sporty feel, you'll get your hands on a 12-button multi-function leather

steering wheel with perforated grip area, flattened bottom section and red contrast stitching. Sports seats featuring ARTICO leather¹/DINAMICA upholstery with red contrast stitching, brushed stainless-steel sports pedals with rubber studs and the lowered comfort suspension complete the unique driving experience.

In addition/replacement to Sport:

Exterior

18" AMG alloy wheels – 5-twin-spoke design painted titanium grey with high-sheen finish

AMG bodystyling

Brakes – front brake calipers with 'Mercedes-Benz' lettering

Brakes – perforated front brake discs

Diamond radiator grille with pins in chrome and silver louvre with chrome insert

Lowered comfort suspension (lowered by 15 mm rear and 20 mm front)

Sports Direct-Steer system

Interior

AMG floor mats with red stitched edging

Brushed stainless steel sports pedals with rubber studs

Carbon-fibre look trim

Sports seats with upholstery in black ARTICO leather¹/DINAMICA microfibre with red contrast stitching

Steering wheel – 12-button multi-function leather steering wheel, 3-spoke design with perforated grip area, flattened bottom section and red contrast stitching

Trim and Upholstery

Carbon-fibre look



ARTICO leather¹/DINAMICA microfibre in black with contrast stitching



¹Man-made leather



> View offers



Book a > test drive > AMG test drive



> Find a Retailer



> View the Range Guide

A-Class Motorsport Edition



Leather/DINAMICA microfibre sports seats



Optional metallic paint shown





> View offers



Book a > test drive > AMG test drive



> Find a Retailer



> View the Range Guide

Inspired by the MERCEDES AMG PETRONAS F1 championship-winning car, the Motorsport Edition celebrates bold colour highlights, starting with 18" AMG multi-spoke alloy wheels with petrol green rim and decorative petrol green strip on the front and rear bumper. The black beltline strips and mirror housings are combined with privacy glass for a powerful effect.

In addition/replacement to AMG Line:

Exterior

- 18" AMG alloy wheels - multi-spoke design painted in black with petrol green rim
- Automatically dimming driver's exterior mirror
- Beltline strips in black
- Diamond grille with pins in chrome and single louvre in high-gloss black with chrome insert
- Electrically folding exterior mirrors
- LED High Performance headlamps with Adaptive Highbeam Assist
- Mirror housings in high-gloss black
- Parking Pilot
- Privacy glass

Interior

- Air vents with black surround, petrol green insert and cruciform nozzle
- Ambient lighting (12-colour)
- AMG floor mats with petrol green stitched edging

Inside, further colour highlights include black leather/DINAMICA microfibre upholstery with petrol green and grey stripes plus petrol green contrast stitching for the heated sports seats, combined with a carbon-fibre look trim. Parking Pilot and Garmin® MAP PILOT navigation system are also standard.

- Automatically dimming rear view mirror
- Black seat belts with petrol green highlight edging
- Dashboard in ARTICO leather¹ with petrol green contrast stitching
- Four-way lumbar support
- Front seats - heated
- Garmin® MAP PILOT navigation system
- Sports seats in black leather/DINAMICA microfibre upholstery with petrol green and grey stripes, and petrol green contrast stitching

Trim and Upholstery

Carbon-fibre look

Leather/DINAMICA microfibre in black with petrol green and grey stripes, and petrol green contrast stitching



¹Man-made leather



> View offers



Book a > test drive > AMG test drive



> Find a Retailer



> View the Range Guide

A-Class 250 AMG



ARTICO leather¹/DINAMICA microfibre sports seats with contrast stitching



Optional alloy wheels (code 693) and metallic paint shown



The A 250 AMG comes with a range of eye-catching highlights including red trim on the front and rear aprons, plus red painted brake calipers with ‘Mercedes-Benz’ lettering on the front calipers. Lowered sports suspension, AMG speed sensitive power steering and modified Electronic Stability Programme (ESP®) configuration ensures you’re set up for a dynamic

In addition/replacement to AMG Line:

Exterior



18" AMG alloy wheels - 5-spoke design in high-sheen finish
AMG speed-sensitive power steering
Automatically dimming driver's exterior mirror
Brakes - front and rear brake calipers painted red with 'Mercedes-Benz' lettering on front
Diamond grille with pins in chrome and single louvre in high-gloss black with chrome insert
Electrically folding exterior mirrors
LED High Performance headlamps with Adaptive Highbeam Assist
Lowered sports suspension 'Engineered by AMG'
Modified Electronic Stability Programme (ESP®) configuration
Parking Pilot
Red trim on front and rear aprons

performance. Inside, you'll notice heated front seats in ARTICO leather¹/DINAMICA microfibre upholstery in black with contrast stitching and red designo seat belts. The air vents also adorn red inserts and a cruciform nozzle. Parking Pilot and Garmin® MAP PILOT navigation system are standard.

Interior

12-colour ambient lighting
Air vents with black surround, red insert and cruciform nozzle
Automatically dimming rear view mirror
designo seat belts in red
Floor mats with red stitched edging and 'Sport' lettering
Front seats - heated
Garmin® MAP PILOT navigation system

Trim and Upholstery

Carbon-fibre look	ARTICO leather ¹ /DINAMICA microfibre in black with contrast stitching
	

¹Man-made leather



> View offers



Book a > test drive > AMG test drive



> Find a Retailer



> View the Range Guide

Executive equipment line



Garmin® MAP PILOT navigation system



Parking Pilot



Heated front seats

The Executive equipment line lets you enjoy each journey that little bit more. It includes Parking Pilot, the highly sophisticated Garmin® MAP PILOT navigation system and heated front seats.

Executive equipment line (code DP3) – designed and priced as a package, including items as listed below.

SE, Sport and AMG Line

Total incl. VAT £995.00

Executive equipment line comprises:

Garmin® MAP PILOT navigation system

Operation via controller, touchpad or voice control. SD card navigation with instructions shown on the Media Display. Includes 3D views with visualisation of roads and buildings as well as junction and lane assistants, making it easy for drivers to orient themselves. Spoken instructions are emitted through vehicle's built-in speakers. Software and map can be updated online

Heated front seats

Parking Pilot



> View offers



Book a > test drive > AMG test drive



> Find a Retailer



> View the Range Guide

Premium equipment line



LED High Performance headlamps with Adaptive Highbeam Assist



Ambient lighting



Automatically dimming driver's exterior mirror

The Premium equipment line increases the comfort of your Sport or AMG Line. This equipment line comprises all the features of the Executive equipment line, as well as ambient lighting, automatically dimming mirrors with electrically folding exterior mirrors and LED High Performance headlamps with Adaptive Highbeam Assist.

Premium equipment line (code DP0) – designed and priced as a package, including items as listed below.

Sport and AMG Line **Total incl. VAT £1,695.00**

Standard on Motorsport Edition, 250 AMG and Mercedes-AMG A45 4MATIC

Premium equipment line comprises:

- _____
Ambient lighting (12-colour)
- _____
Automatically dimming driver's exterior mirror and rear view mirror
- _____
Electrically folding exterior mirrors
- _____
Garmin® MAP PILOT navigation system
- _____
Heated front seats
- _____
LED High Performance headlamps with Adaptive Highbeam Assist
- _____
Parking Pilot



Premium Plus equipment line



Panoramic glass sunroof



Electrically adjustable front seats



KEYLESS-GO

If you want to take it up a notch, the Premium Plus equipment line for the Sport or AMG Line contains the same features as the Premium equipment line plus KEYLESS-GO for keyless locking, unlocking and starting; electrically adjustable front seats with four-way lumbar support; and a panoramic glass sunroof to brighten up the cabin.

Premium Plus equipment line (code DP1) – designed and priced as a package, including items as listed below.

Sport and AMG Line

Total incl. VAT £2,995.00

Premium Plus equipment line comprises:

- Ambient lighting (12-colour)

- Automatically dimming driver's exterior mirror and rear view mirror

- Electrically adjustable front seats with four-way lumbar support. Exterior passenger mirror pivots down when reverse is selected. Memory programme with three individually selectable settings

- Electrically folding exterior mirrors

- Garmin® MAP PILOT navigation system

- Heated front seats

- KEYLESS-GO – keyless locking, unlocking and start of the vehicle

- LED High Performance headlamps with Adaptive Highbeam Assist

- Panoramic glass sunroof (black roof lining as standard)

- Parking Pilot



> View offers



Book a > test drive > AMG test drive



> Find a Retailer



> View the Range Guide

Mercedes-AMG A 45 4MATIC



AMG Performance seats



Model shown features AMG Night package (code P60) and AMG Aerodynamic package (code B26)



> View offers



Book a > test drive > AMG test drive



> Find a Retailer



> View the Range Guide

The Mercedes-AMG A45 4MATIC is bursting with AMG credentials ranging from the AMG front apron with front splitter in titanium grey with black flics, 18" AMG alloy wheels with red brake calipers and 'AMG' lettering, as well as the AMG sports exhaust system with two twin chrome-plated tailpipes and an AMG diffuser-look rear apron. Inside, you'll notice the AMG

In addition/replacement to 250 AMG:

Exterior



- 18" AMG alloy wheels – 10-spoke design
- AMG diffuser-look rear apron
- AMG front apron with front splitter in titanium grey with black flics
- AMG grille with twin louvre in silver and 'AMG' lettering
- AMG high-performance braking system with 3-stage ESP®
- AMG roof spoiler lip
- AMG side skirt panels with inserts in matt titanium grey
- AMG speed-sensitive sports steering
- AMG SPEEDSHIFT DCT 7-speed automatic sports transmission including RACE START and 'Sailing' function
- AMG sports exhaust system with two twin chrome-plated tailpipes
- AMG sports suspension
- AMG-tuned Electronic Stability Programme (ESP®) with Acceleration Skid Control (ASR)
- Brakes – front and rear brake calipers painted red with 'AMG' lettering

performance steering wheel in nappa leather/DINAMICA microfibre with 12-o'clock marking and aluminium gearshift paddles. For a truly engaging ride, enjoy AMG Performance seats for both driver and front passenger as well as advanced technology like AMG DYNAMIC SELECT with a choice of four driving modes.

Interior

- AMG DRIVE UNIT – E-SELECT gearshift lever with leather embossed AMG emblem and main key with AMG emblem
- AMG DYNAMIC SELECT – with a choice of driving modes: Comfort, Sport, Sport+ and Individual
- AMG floor mats with red stitched edging
- AMG instrument cluster with colour display and AMG menu
- AMG Performance seats – driver and front passenger
- AMG performance steering wheel in nappa leather/DINAMICA microfibre with aluminium gearshift paddles

Trim and Upholstery

Carbon-fibre look	ARTICO leather ¹ /DINAMICA microfibre in black with contrast stitching
	

¹Man-made leather



Premium equipment line for Motorsport Edition, 250 AMG and Mercedes-AMG A 45 4MATIC



Why not enhance the Motorsport Edition, 250 AMG or Mercedes-AMG A 45 4MATIC even further by adding the Premium equipment line? It comes with the sophisticated Harman Kardon® Logic 7® surround sound system, electrically adjustable front seats with four-way lumbar support; KEYLESS-GO for keyless locking, unlocking and starting and a panoramic glass sunroof.

Premium equipment line (code DP0) – designed and priced as a package, including items as listed below. **Total incl. VAT £1,895.00**

Premium equipment line comprises:

Electrically adjustable driver and front passenger seats with four-way lumbar support.
Exterior passenger mirror pivots down when reverse is selected. Memory programme with three individually selectable settings

Harman Kardon® Logic 7® surround sound system with Dolby Digital 5.1 and DTS

KEYLESS-GO – keyless locking, unlocking and start of the vehicle

Panoramic glass sunroof

Panoramic glass sunroof



Harman Kardon® Logic 7®



KEYLESS-GO



Exclusive driver training for Mercedes-AMG owners

All Mercedes-AMG customers are invited to a complimentary AMG Driving Academy Training experience at Mercedes-Benz World.



With friendly one-to-one tuition from a professional Mercedes-AMG driver, your training will be personalised to you. You'll push Mercedes-AMG driving performance and your driving skills to the limits on our track and purpose-built low friction dynamic handling facilities.

Through high-speed and adrenaline-fuelled exercises you'll experience oversteer, understeer, slaloms and many more performance driving skills. Designed as part of your ownership experience, this will lay the foundations to master a high-performance vehicle, develop driving skills with maximum enjoyment and prepare you to take full command of your own Mercedes-AMG.

TERMS AND CONDITIONS

The following only are eligible: the first purchaser/registered keeper of a newly-registered Mercedes-AMG; the second owner/registered keeper of a Mercedes-AMG purchased from a Mercedes-Benz Retailer, where the vehicle is less than 90 days from registration. The AMG Driving Academy Training experience is the AMG BASIC-Training as detailed in the further information above and must be booked and taken within six months of delivery of your Mercedes-AMG; it cannot be exchanged and cannot be transferred for any other driving experience. The Training experience is available Monday to Friday only and is subject to availability. Mercedes-Benz UK Limited reserves the right to amend or withdraw this Training experience. Attendees must hold a full UK driving licence. Attendees will be required to sign the Mercedes-Benz World Driving Risk Acknowledgement prior to undertaking the Training experience. The Training experience is also subject to the Mercedes-Benz World Terms and Conditions, as applicable.



> View offers



Book a > test drive > AMG test drive



> Find a Retailer



> View the Range Guide





Pricing summary for model and equipment lines

Model	Transmission	Recommended OTR price (£) ¹									
		SE	SE Executive	Sport	Sport Executive	Sport Premium	Sport Premium Plus	AMG Line	AMG Line Executive	AMG Line Premium	AMG Line Premium Plus
A 180 d	6-speed manual	22,485.00	23,480.00	23,480.00	24,475.00	25,175.00	26,475.00	24,775.00	25,770.00	26,470.00	27,770.00
	7G-DCT 7-speed auto.	23,985.00	24,980.00	24,980.00	25,975.00	26,675.00	27,975.00	26,275.00	27,270.00	27,970.00	29,270.00
A 200 d	6-speed manual	23,560.00	24,555.00	24,555.00	25,550.00	26,250.00	27,550.00	25,850.00	26,845.00	27,545.00	28,845.00
	7G-DCT 7-speed auto.	25,060.00	26,055.00	26,055.00	27,050.00	27,750.00	29,050.00	27,350.00	28,345.00	29,045.00	30,345.00
A 220 d	7G-DCT 7-speed auto.	-	-	-	-	-	-	28,780.00	29,775.00	30,475.00	31,775.00
A 220 d 4MATIC	7G-DCT 7-speed auto.	-	-	-	-	-	-	30,280.00	31,275.00	31,975.00	33,275.00
A 160	6-speed manual	19,990.00	20,985.00	20,985.00	21,980.00	22,680.00	23,980.00	22,280.00	23,275.00	23,975.00	25,275.00
	7G-DCT 7-speed auto.	21,490.00	22,485.00	22,485.00	23,480.00	24,180.00	25,480.00	23,780.00	24,775.00	25,475.00	26,775.00
A 180	6-speed manual	21,410.00	22,405.00	22,535.00	23,530.00	24,230.00	25,530.00	23,830.00	24,825.00	25,525.00	26,825.00
	7G-DCT 7-speed auto.	22,910.00	23,905.00	23,905.00	24,900.00	25,600.00	26,900.00	25,200.00	26,195.00	26,895.00	28,195.00
A 200	6-speed manual	-	-	24,060.00	25,055.00	25,755.00	27,055.00	25,355.00	26,350.00	27,050.00	28,350.00
	7G-DCT 7-speed auto.	-	-	25,430.00	26,425.00	27,125.00	28,425.00	26,725.00	27,720.00	28,420.00	29,720.00

¹ Recommended on-the-road price: these prices reflect the Road Fund Licence applicable to the standard model plus £670.00 additional costs necessary to put your car on the road.

Included are a standard UK delivery charge (£540.00 incl. VAT), new vehicle registration fee (£55.00), number plates (£25.00 incl. VAT) and fuel (£50.00 incl. VAT). VAT is calculated at the standard rate of 20%

[View offers](#)[Book a test drive](#) [AMG test drive](#)[Find a Retailer](#)[View the Range Guide](#)

Pricing summary for model and equipment lines

34

Model	Transmission	Recommended OTR price (£) ¹					
		Motorsport Edition	Motorsport Edition Premium	250 AMG	250 AMG Premium	A 45 4MATIC	A 45 4MATIC Premium
A 220 d	7G-DCT 7-speed auto.	32,030.00	33,925.00	-	-	-	-
A 220 d 4MATIC	7G-DCT 7-speed auto.	33,530.00	35,425.00	-	-	-	-
A 250	6-speed manual	-	-	29,345.00	31,240.00	-	-
	7G-DCT 7-speed auto.	-	-	30,805.00	32,700.00	-	-
A 250 4MATIC	7G-DCT 7-speed auto.	-	-	32,345.00	34,240.00	-	-
A 45 4MATIC	7G-DCT 7-speed auto.	-	-	-	-	40,695.00	42,590.00

¹Recommended on-the-road price: these prices reflect the Road Fund Licence applicable to the standard model plus £670.00 additional costs necessary to put your car on the road.

Included are a standard UK delivery charge (£540.00 incl. VAT), new vehicle registration fee (£55.00), number plates (£25.00 incl. VAT) and fuel (£50.00 incl. VAT). VAT is calculated at the standard rate of 20%



Standard equipment

Item	SE	Sport	AMG Line	Motorsport Edition	250 AMG	Mercedes-AMG A 45 4MATIC
Transmission and Suspension						
Cruise Control with Limiter	●	●	●	●	●	●
Driving modes – AMG DYNAMIC SELECT with a choice of driving modes: Comfort, Sport, Sport+ and Individual	-	-	-	-	-	●
Driving modes – DYNAMIC SELECT with a choice of driving modes: ECO, Comfort, Sport and Individual	△	●	●	●	●	-
ECO start/stop function	●	●	●	●	●	●
Suspension – AMG sports suspension	-	-	-	-	-	●
Suspension – comfort suspension	△	●	-	-	-	-
Suspension – lowered comfort suspension (lowered by 15 mm rear and 20 mm front)	△	-	●	●	-	-
Suspension – lowered sports suspension	-	-	-	-	●	-
Transmission – 6-speed manual transmission with shift point indicator	△	△	△	-	△	-
Transmission – 7G-DCT 7-speed automatic transmission with DIRECT SELECT gearshift lever and steering wheel gearshift paddles	△	△	△	●	△	-
Transmission – AMG SPEEDSHIFT DCT 7-speed automatic sports transmission and aluminium steering wheel gearshift paddles	-	-	-	-	-	●

Item	SE	Sport	AMG Line	Motorsport Edition	250 AMG	Mercedes-AMG A 45 4MATIC
Exterior						
AMG 'A-wing' front air intake	-	-	-	-	-	●
AMG bodystyling – front apron, rear apron and side skirts	-	-	●	●	●	●
AMG diffuser-look rear apron	-	-	-	-	-	●
Beltline strips – black	-	-	△	●	-	△
Beltline strips – chrome	●	●	●	-	●	●
Bodystyling – side skirts, body-coloured	●	●	●	●	●	●
Brakes – calipers front and rear painted red with 'AMG' lettering on front and rear calipers	-	-	-	-	-	●
Brakes – calipers front and rear painted red with 'Mercedes-Benz' lettering on front calipers	-	-	-	-	●	-
Brakes – calipers with 'Mercedes-Benz' lettering on front	-	-	●	●	-	-
Brakes – perforated front brake discs	-	-	●	●	●	●
Bumpers – body-coloured	●	●	●	-	-	●
Bumpers – body-coloured with decorative petrol green strip on front and rear bumper	-	-	-	●	-	-
Bumpers – body-coloured with decorative red strip on front and rear bumper	-	-	-	-	●	-
Door handles – body-coloured	●	●	●	●	●	●



Item	SE	Sport	AMG Line	Motorsport Edition	250 AMG	Mercedes-AMG A 45 4MATIC
Exterior (continued)						
Door mirrors – electrically adjustable and heated with integrated LED indicators	●	●	●	●	●	●
Door mirrors – electrically folding and auto-dimming (driver's side)	-	△	△	●	●	●
Door mirrors – mirror housing in black	-	-	△	●	-	△
Door sills – front door sills with 'Mercedes-Benz' lettering	●	-	-	-	-	-
Door sills – illuminated front door sills with 'AMG' lettering	-	-	-	-	-	●
Door sills – illuminated front door sills with 'Mercedes-Benz' lettering	-	●	●	●	●	-
Exhaust system – AMG sports exhaust system with two twin chrome-plated tailpipes	-	-	-	-	-	●
Exhaust system – no visible tailpipes	●	-	-	-	-	-
Exhaust system – twin trapezoidal tailpipes in polished stainless steel	-	●	●	●	●	-
Glass – privacy glass from B-pillar backwards	○	○	○	●	○	○
Glass – rear windscreen, heated with timer control	●	●	●	●	●	●
Lights – halogen headlamps with integrated daytime running lights	●	●	●	-	-	-
Lights – high-level third brake light, LED	●	●	●	●	●	●
Lights – LED High Performance headlamps with integrated LED daytime running lights and Adaptive Highbeam Assist	-	△	△	●	●	●

Item	SE	Sport	AMG Line	Motorsport Edition	250 AMG	Mercedes-AMG A 45 4MATIC
Lights – LED tail lamps	-	△	△	●	●	●
Lights – part-LED tail lamps	●	●	●	-	-	-
Parking – Parking Pilot	○	○	○	●	●	●
Parking – reversing camera with parking guidelines, 180° view	●	●	●	●	●	●
Radiator grille – diamond radiator grille in black with one louvre painted in vehicle colour and chrome insert	●	-	-	-	-	-
Radiator grille – diamond radiator grille in black with one silver-painted louvre and chrome insert	-	●	-	-	-	-
Radiator grille – diamond radiator grille with pins in chrome and silver louvre with chrome insert	-	-	●	-	-	-
Radiator grille – diamond radiator grille with pins in chrome and single louvre in high-gloss black with chrome insert	-	-	-	●	●	-
Radiator grille – AMG grille with twin louvre in silver and 'AMG' lettering	-	-	-	-	-	●
Wiper system – heated windscreen washer system	-	-	-	-	●	●
Wiper system – rear windscreen wiper	●	●	●	●	●	●



Standard equipment

37

Item	SE	Sport	AMG Line	Motorsport Edition	250 AMG	Mercedes-AMG A 45 4MATIC
Interior						
AMG DRIVE UNIT including AMG DYNAMIC SELECT controller	-	-	-	-	-	●
Air conditioning – air vents with black surround, petrol green insert and cruciform nozzle	-	-	-	●	-	-
Air conditioning – air vents with black surround, red insert and cruciform nozzle	-	-	-	-	●	●
Air conditioning – air vents with surround and cruciform nozzle in silver chrome	●	●	●	-	-	-
Air conditioning – THERMATIC	●	-	-	-	-	-
Air conditioning – THERMOTRONIC luxury automatic climate control, two-zone, with display	-	●	●	●	●	●
Centre armrest – front, with stowage	●	●	●	●	●	●
Controller on centre console with chrome surround	●	●	●	●	●	●
Cup holder – twin, front	●	●	●	●	●	●
Dashboard – upper section in ARTICO leather ¹ with contrast stitching	-	-	△	●	△	△
Direction indicators with lane-changer function	●	●	●	●	●	●
Electronic key – chrome surround	●	●	●	●	●	-
Electronic key – chrome surround, with AMG crest for master key	-	-	-	-	-	●

Item	SE	Sport	AMG Line	Motorsport Edition	250 AMG	Mercedes-AMG A 45 4MATIC
Floor mats – with petrol green stitched edging and 'AMG' lettering	-	-	-	●	-	-
Floor mats – with red stitched edging and 'AMG' lettering	-	-	●	-	-	●
Floor mats – with red stitched edging and 'Sport' lettering	-	-	-	-	●	-
Gearshift – leather-trimmed	△	△	△	-	△	-
Instrument cluster – AMG instrument cluster with colour display and AMG menu	-	-	-	-	-	●
Instrument cluster – fluid level warning indicator for fuel, oil, coolant and washer fluid	●	●	●	●	●	●
Instrument cluster – outside temperature gauge	●	●	●	●	●	●
Instrument cluster – service indicator ASSYST	●	●	●	●	●	●
Instrument cluster – trip computer in multi-function display with current consumption indicator (operated via steering wheel)	●	●	●	●	●	●
Instrument cluster – with four analogue dials and needles suspended in six o'clock position	●	●	●	●	●	●
Interior lighting – footwell lights in front and rear	-	●	●	●	●	●
Interior lighting – lighting in stowage compartment and vanity mirrors	-	●	●	●	●	●
Interior lighting – reading lights and console light in front and rear	-	●	●	●	●	●



Item	SE	Sport	AMG Line	Motorsport Edition	250 AMG	Mercedes-AMG A 45 4MATIC
Interior (continued)						
Interior lighting – single-colour ambient lighting in headrests and interior door handles	-	-	●	●	●	-
Pedals – brushed stainless-steel sports pedals with rubber studs	-	-	●	●	●	●
Rear view mirror – additional lighting	-	●	●	●	●	●
Rear view mirror – auto-dimming	-	△	△	●	●	●
Seats – Seat Comfort package Seat height adjusters and seat cushion angle adjustment on front seats	●	●	●	●	●	●
Seats – AMG Performance seats Driver and front passenger seats featuring more sharply contoured seat shape for enhanced lateral support, integrated head restraints and AMG badge in seat backrests	-	-	-	-	-	●
Seats – four-way lumbar support for driver and front passenger	○	○	○	○	○	△
Seats – front seats cushion length adjustment	●	●	●	●	●	-
Seats – front seats, heated	△	△	△	●	●	●
Seats – front seats, manually adjustable	●	●	●	●	●	●
Seats – rear seat backrests, split folding (1/3:2/3)	●	●	●	●	●	●
Seats – seats with adjustable head restraints	●	●	-	-	-	-
Seats – sports seats with integrated head restraints	-	-	●	●	●	-

Item	SE	Sport	AMG Line	Motorsport Edition	250 AMG	Mercedes-AMG A 45 4MATIC
Seat belts – outer, black with petrol green edging	-	-	-	●	-	-
Seat belts – outer, designo seat belts in red	-	-	-	-	●	●
Stowage – boxes under front seats	●	●	●	●	●	-
Stowage – compartment beneath load compartment floor	●	●	●	●	●	-
Stowage – compartment, illuminated	-	●	●	●	●	●
Stowage – glove compartment, illuminated	●	●	●	●	●	●
Stowage – load-securing rings in luggage compartment	●	●	●	●	●	●
Stowage – luggage compartment, 12 V socket	●	●	●	●	●	●
Stowage – luggage compartment cover	●	●	●	●	●	●
Stowage – luggage net under parcel shelf and on the left and right in luggage compartment	●	●	●	●	●	●
Stowage – luggage nets on the rear of front seats	●	●	●	●	●	-
Stowage – net in passenger footwell	●	●	●	●	●	●
Stowage – spectacles compartment in overhead control panel	●	●	●	●	●	●
Windows – electric windows (4)	●	●	●	●	●	●



Item	SE	Sport	AMG Line	Motorsport Edition	250 AMG	Mercedes-AMG A 45 4MATIC
Steering						
Steering – AMG speed-sensitive sports steering	-	-	-	-	●	●
Steering – speed-sensitive power steering	●	●	-	-	-	-
Steering – Sports Direct-Steer system with speed-sensitive servo assistance	-	-	●	●	-	-
Steering column – manually adjustable for height and reach	●	●	●	●	●	●
Steering wheel – 3-spoke multi-function, trimmed in leather	●	-	-	-	-	-
Steering wheel – 3-spoke multi-function, trimmed in leather with perforated leather in grip area	-	●	-	-	-	-
Steering wheel – 3-spoke multi-function, trimmed in leather with perforated leather in grip area, flattened bottom section	-	-	●	●	●	-
Steering wheel – AMG performance steering wheel – 3-spoke multi-function, trimmed in nappa leather/DINAMICA microfibre with aluminium gearshift paddles, red 12 o'clock marker and 'AMG' lettering	-	-	-	-	-	●

Item	SE	Sport	AMG Line	Motorsport Edition	250 AMG	Mercedes-AMG A 45 4MATIC
Paint, Trim and Upholstery						
Paint – non-metallic	●	●	●	●	●	●
Roof lining – black	-	△	●	●	●	●
Roof lining – grey (reverts to black in conjunction with panoramic roof)	●	●	-	-	-	-
Trim – chequerboard	-	●	-	-	-	-
Trim – carbon-fibre look	-	-	●	●	●	●
Trim – honeycomb	●	-	-	-	-	-
Upholstery – ARTICO leather ¹	●	●	-	-	-	-
Upholstery – ARTICO leather ¹ /DINAMICA microfibre with contrast stitching	-	-	●	-	●	●
Upholstery – leather/DINAMICA microfibre in black with petrol green and grey stripes and green contrast stitching	-	-	-	●	-	-



Item	SE	Sport	AMG Line	Motorsport Edition	250 AMG	Mercedes-AMG A 45 4MATIC
Communications and In-Car Entertainment						
Audio 20 radio/single CD – 6 speakers, telephone keypad, twin radio tuner (FM/AM), CD player (MP3/WMA/AAC/WAV compatible), Bluetooth® interface, 2 USB ports, SD card slot and pre-installation for Garmin® MAP PILOT	●	●	●	●	●	●
DAB digital radio tuner	○	○	○	○	○	●
Garmin® MAP PILOT navigation system	○	○	○	●	●	●
Media display – 7-inch Media Display	●	-	-	-	-	-
Media display – 8-inch Media Display	-	●	●	●	●	●
Media Interface Allows connection and control of portable media devices (e.g. MP3 player, USB storage media) via ports in the centre console (input only)	●	●	●	●	●	●
Mercedes me connect (standard services) Including emergency call system (eCall), accident recovery, breakdown management and maintenance management	●	●	●	●	●	●

Item	SE	Sport	AMG Line	Motorsport Edition	250 AMG	Mercedes-AMG A 45 4MATIC
Radio aerial integrated into roof spoiler	●	●	●	●	●	●
Smartphone integration Comprising Apple CarPlay™ and Android Auto. Please check on www.apple.com/uk/ios/carplay/ or www.android.com/intl/en_uk/auto for compatibility and approved apps. Certain features and apps require a 3G or 4G data connection. Control of features available through voice control and controller on centre console	●	●	●	●	●	●



Item	SE	Sport	AMG Line	Motorsport Edition	250 AMG	Mercedes-AMG A 45 4MATIC
Safety and Assistance Systems						
Active Brake Assist	●	●	●	●	●	●
Active bonnet – pedestrian safety measure which detects an impact and raises bonnet by 65 mm	●	●	●	●	●	●
Airbags – dual-stage, driver and front passenger	●	●	●	●	●	●
Airbags – head and sidebags, driver and front passenger	●	●	●	●	●	●
Airbags – kneebag for driver	●	●	●	●	●	●
Airbags – windowbags, driver and front passenger	●	●	●	●	●	●
Alarm system with immobiliser and interior protection – Thatcham category 1 (T1)	●	●	●	●	●	●
ATTENTION ASSIST – monitors steering behaviour and can help alert to long journey fatigue	●	●	●	●	●	●
Braking – adaptive Brake Assist with HOLD function and Hill Start Assist	●	●	●	●	●	●
Braking – adaptive brake lights	●	●	●	●	●	●
Braking – anti-lock braking system (ABS) with Brake Assist (BAS)	●	●	●	●	●	●
Braking – brake-pad wear warning indicator	●	●	●	●	●	●
Crash-responsive emergency lighting	●	●	●	●	●	●
Electric parking brake	●	●	●	●	●	●
Electronic Stability Programme (ESP®) with Acceleration Skid Control (ASR)	●	●	●	●	●	-
Electronic Stability Programme (ESP®) – three-stage	-	-	-	-	-	●

Item	SE	Sport	AMG Line	Motorsport Edition	250 AMG	Mercedes-AMG A 45 4MATIC
ESP® Curve Dynamic Assist	●	●	●	●	●	●
First-aid kit and warning triangle	●	●	●	●	●	●
Headlamp Assist – automatic headlamp activation	●	●	●	●	●	●
Lamp failure indicator	●	●	●	●	●	●
Locking – childproof locks, manually operated for rear doors and electrically operated for rear power windows	●	●	●	●	●	●
Locking – remote central locking and crash sensor with emergency opening function	●	●	●	●	●	●
Rain-sensing windscreen wipers with two sensitivity settings	-	●	●	●	●	●
Rear fog lamp	●	●	●	●	●	●
Seats – automatic child seat recognition sensor	●	●	●	●	●	●
Seats – ISOFIX and top-tether child seat fixing points in rear (two outer seats)	●	●	●	●	●	●
Seats – seat occupancy sensor, front passenger seat	●	●	●	●	●	●
Seat belts – reminder, front and rear	●	●	●	●	●	●
Seat belts – three-point, rear (3)	●	●	●	●	●	●
Tyres – TIREFIT tyre-sealant kit	●	●	●	●	●	●
Tyres – tyre pressure monitoring system	●	●	●	●	●	●



A revolution in style

Item	Notes		SE	Sport	AMG Line	Motorsport Edition	250 AMG	Mercedes-AMG A45 4MATIC	Basic RRP excl. VAT (£)	Total RRP incl. VAT (£)
Wheels										
16" alloy wheels (4) – 5-twin-spoke design, painted in black with high-shine finish 205/55 tyres			R78	●	-	-	-	-	-	-
17" alloy wheels (4) – 5-twin-spoke design 225/45 tyres			76R	-	●	-	-	-	-	-
18" AMG alloy wheels (4) – 5-twin-spoke design, painted in titanium grey with high-shine finish 225/40 tyres			678	-	-	●	-	-	-	-

● Standard ○ Optional - Not available



> View offers





Book a > test drive > AMG test drive



> Find a Retailer



> View the Range Guide

Item	Notes		SE	Sport	AMG Line	Motorsport Edition	250 AMG	Mercedes-AMG A45 4MATIC	Basic RRP excl. VAT (£)	Total RRP incl. VAT (£)
Wheels (continued)										
18" AMG alloy wheels (4) - multi-spoke design 225/40 tyres	Not in conjunction with Night package (code P55)		791	-	-	○	-	-	100.00	120.00
18" AMG alloy wheels (4) - multi-spoke design, painted in black with high-sheen rim 225/40 tyres			646	-	-	△	-	-	Included in Night package	
18" AMG alloy wheels (4) - multi-spoke design, painted in black with petrol green rim 225/40 tyres			ROW	-	-	-	●	-	-	-

● Standard ○ Optional - Not available △ Dependent on chosen equipment



> View offers





Book a > test drive > AMG test drive



> Find a Retailer



> View the Range Guide

Item	Notes		SE	Sport	AMG Line	Motorsport Edition	250 AMG	Mercedes-AMG A45 4MATIC	Basic RRP excl. VAT (£)	Total RRP incl. VAT (£)
Wheels (continued)										
18" AMG alloy wheels (4) – 5-spoke design, painted in black with high-sheen finish 235/40 tyres			774	-	-	-	-	●	-	-
19" AMG alloy wheels (4) – multi-spoke design, painted in black with high-sheen finish 235/35 tyres			693	-	-	-	-	○	495.83	595.00
18" AMG alloy wheels (4) – 10-spoke design, painted in titanium grey with high-sheen finish 235/40 tyres			756	-	-	-	-	●	-	-

● Standard ○ Optional - Not available



> View offers



Book a > test drive > AMG test drive



> Find a Retailer



> View the Range Guide

Wheels

45

Item	Notes		638	SE	Sport	AMG Line	Motorsport Edition	250 AMG	Mercedes-AMG A45 4MATIC	Basic RRP excl. VAT (£)	Total RRP incl. VAT (£)
Wheels (continued)											
19" AMG alloy wheels (4) – cross-spoke design, painted in titanium grey with high-sheen finish 235/35 tyres			638	-	-	-	-	-	○	495.83	595.00
19" AMG alloy wheels (4) – cross-spoke design, painted in matt black with high-sheen rim 235/35 tyres			99R	-	-	-	-	-	△	Included in AMG Night package	

● Standard ○ Optional - Not available △ Dependent on chosen equipment



Exclusive package



This optional Exclusive package fills the interior of the A-Class AMG Line,¹ 250 AMG and Mercedes-AMG A 45 4MATIC² with even more luxurious touches. It includes four-way lumbar support for both driver and front passenger and a choice of black, hazelnut brown or sahara beige/black leather upholstery; complemented by ARTICO leather³ upper dash trim with contrast stitching and floor mats with contrast edging.

Exclusive package (code P34) – designed and priced as a package, including items as listed below.

AMG Line,¹ 250 AMG and Mercedes-AMG A 45 4MATIC² Total incl. VAT £895.00

Exclusive package comprises:

Belt guide optics in silver-chrome look (Mercedes-AMG A 45 4MATIC only)

Floor mats with edging in appointments colour

Four-way lumbar support

Trim – ARTICO leather³ upper dash trim with contrast stitching

Exclusive package trim and upholstery

Black	Hazelnut brown	Sahara beige/black
Black perforated leather-look trim	Brown perforated leather-look trim	Black perforated leather-look trim

¹Available only in conjunction with Executive, Premium, or Premium Plus equipment line (code DP3, DP0 and DP1) ²Available only in conjunction with Premium equipment line (code DP0) ³Man-made leather



AMG Exclusive package

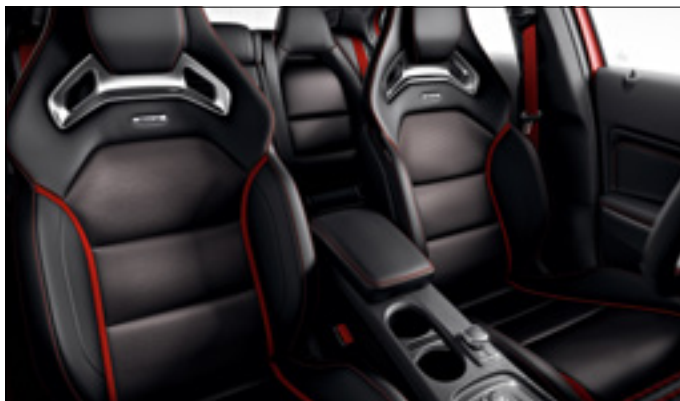

Your A-Class AMG Line,¹ 250 AMG or Mercedes-AMG A 45 MATIC² can also be fitted with the optional AMG Exclusive package, containing perforated black RED CUT leather upholstery and ARTICO leather³ upper dash trim with red contrast stitching. Red designo seat belts⁴ and four-way lumbar support also form part of this package.

AMG Exclusive package (code P39) – designed and priced as a package, including items as listed below.

AMG Line,¹ 250 AMG and Mercedes-AMG A 45 4MATIC² Total incl. VAT £895.00

AMG Exclusive package comprises:

Belt guide optics in silver-chrome look (Mercedes-AMG A 45 4MATIC only)

Four-way lumbar support

Red designo seat belts (not available with AMG Line)

Trim – ARTICO leather³ upper dash trim with red contrast stitching

Upholstery – perforated black RED CUT leather with contrast stitching

AMG Exclusive package trim and upholstery

Perforated black RED CUT leather

Carbon-fibre look trim



AMG Performance seats as shown above are only available for Mercedes-AMG A 45 4MATIC ¹Available only in conjunction with Executive, Premium or Premium Plus equipment line (code DP3, DP0 and DP1) ²Available only in conjunction with Premium equipment line (code DP0) ³Man-made leather ⁴Black seat belts are selectable for 250 AMG and Mercedes-AMG A 45 4MATIC with code U17



Night package



For a truly distinctive look, the A-Class AMG Line can be further enhanced with the Night package. It includes black door mirror housings, black beltline strips, 18" AMG multi-spoke alloy wheels painted in black, as well as privacy glass for the rear windscreen and rear side windows.

Night package (code P55) – designed and priced as a package, including items as listed below.

AMG Line

Total incl. VAT £495.00

Night package comprises:

18" AMG multi-spoke alloy wheels painted in black (code 646)

Beltline strips – black

Door mirror housings – black

Privacy glass from B-pillar backwards





AMG Night package



The AMG Night package for the Mercedes-AMG A45 4MATIC offers extensive exterior features to strengthen its sporty appearance. Front splitter, inserts on the side sill panels, exterior mirror housings as well as beltline trim strips all come in black. Also part of this stunning package are matt black painted 19" AMG alloy wheels in cross-spoke design with a high-sheen rim, chrome-plated tailpipe trim in black and privacy glass for the rear and rear side windows.

AMG Night package (code P60) – designed and priced as a package, including items as listed below.

Mercedes-AMG A 45 4MATIC

Total incl. VAT £1,595.00

AMG Night package comprises:

- 19" AMG cross-spoke alloy wheels painted in matt black with a high-sheen rim (code 99R)
- Beltline strips – black
- Black chrome-plated tailpipe trim
- Door mirror housings – black
- Front splitter – black
- Inserts on side sills – black
- Privacy glass from B-pillar backwards
- Rear diffuser-look apron – black



Optional special metallic paint shown



Lane Tracking package and Driving Assistance package

Both of these packages contain highly intelligent features to help you stay safe on the road – by making the drive more effortless, and to alert you to any emergency. The Lane Tracking package includes Blind Spot Assist and Lane Keeping Assist. Distance Pilot DISTRONIC is part of the Driving Assistance package only.

Item	Notes	Lane Tracking package £595.00 (code 22P)	Driving Assistance package £1,695.00 ¹ (code DP2)
Blind Spot Assist	Blind Spot Assist is able to detect vehicles in the blind spot and give the driver visible and audible warnings	■	■
Lane Keeping Assist	Lane Keeping Assist is able to detect when the vehicle is unintentionally drifting out of lane, duly warning the driver by means of pulsed vibrations through the steering wheel	■	■
Distance Pilot DISTRONIC	Distance Pilot DISTRONIC helps the driver to maintain a safe distance to the vehicle in front and so relieves strain on the driver, especially on long journeys or in a traffic jam	–	■
PRE-SAFE [®] anticipatory safety system	The renowned PRE-SAFE [®] safety system can 'sense' critical road situations and initiate preventive safety measures	–	■

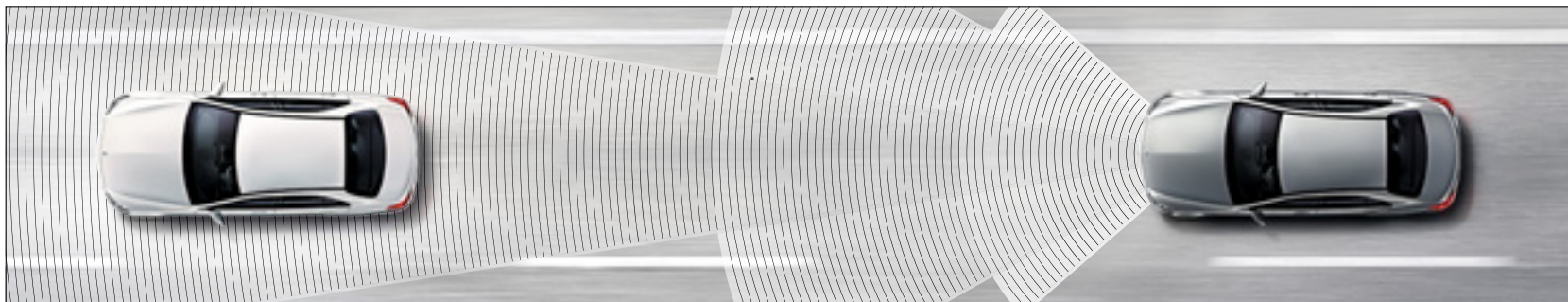

Distance Pilot DISTRONIC

■ Included – Not included ¹Only in conjunction with automatic transmission



Optional equipment

Item	Notes		SE	Sport	AMG Line	Motorsport Edition	250 AMG	Mercedes-AMG A45 4MATIC	Basic RRP excl. VAT (£)	Total RRP incl. VAT (£)
Suspension and Exterior										
AMG Aerodynamic package AMG rear aerofoil in high-gloss black Large front splitter with additional flics in high-gloss black	Only in conjunction with AMG Night package (code P60)	B26	-	-	-	-	-	○	1,275.00	1,530.00
AMG Driver's package Includes an increase to your vehicle's electronically limited top speed (168 mph) and participation in one of the AMG BASIC-Training 'Power and Passion' events. The event is run by the AMG Driving Academy and held at a racetrack located in mainland Europe	For further information on this or any other AMG Driving Academy training, please speak to your Retailer, or visit www.mercedes-amg.com/driving-academy	250	-	-	-	-	-	○	1,616.67	1,940.00
AMG DYNAMIC PLUS package AMG front axle differential lock AMG RIDE CONTROL sports suspension with Selective Damping		P71	-	-	-	-	-	○	1,162.50	1,395.00
AMG carbon-fibre exterior mirror housings		B28	-	-	-	-	-	○	1,025.00	1,230.00
AMG Performance exhaust Includes twin tailpipe design with louder exhaust note and button in upper control panel for more emotional engine sound in interior		U21	-	-	-	-	-	○	425.00	510.00
AMG performance steering wheel in DINAMICA microfibre		L6G	-	-	-	-	-	○	79.17	95.00
AMG RIDE CONTROL sports suspension with Selective Damping Provides the option to adjust suspension settings between 'Comfort' and 'Sport' using the DYNAMIC SELECT switch. Additional 'Race' transmission mode designed for maximum driving dynamics	Included in AMG DYNAMIC PLUS package (code P71)	459	-	-	-	-	-	○	495.83	595.00
Selective Damping Provides the option to adjust suspension settings between 'Comfort' and 'Sport' using the DYNAMIC SELECT switch		459	-	-	○	○	○	-	495.83	595.00
Tow bar – manually folding with mechanical release; includes 13-pin socket	Not in conjunction with A 180 d SE (manual)	550	○	○	-	-	-	-	675.00	810.00

[View offers](#)[Book a test drive](#) [AMG test drive](#)[Find a Retailer](#)[View the Range Guide](#)

Optional equipment

52

Item	Notes		SE	Sport	AMG Line	Motorsport Edition	250 AMG	Mercedes-AMG A45 4MATIC	Basic RRP excl. VAT (£)	Total RRP incl. VAT (£)
Paint, Trim and Upholstery										
Black seat belts	In conjunction with AMG Exclusive package (code P39)	U17	-	-	-	-	○	○	no-cost option	
Paint - metallic		-	○	○	○	○	○	○	479.17	575.00
Paint - special metallic paint, designo magno mountain grey		662	-	-	-	○	○	○	1,495.83	1,795.00
Comfort										
Four-way lumbar support	Included in Exclusive package (code P34) or AMG Exclusive package (code P39)	U22	○	○	○	●	○	-	133.33	160.00
Panoramic glass sunroof	Included in Premium Plus equipment line (code DP1). Black roof lining as standard	413	-	○	○	-	-	-	829.17	995.00
	Included in Premium equipment line (DP0)		-	-	-	○	○	○	829.17	995.00
Privacy glass - heat insulating dark-tinted glass all round from B-pillars backwards	Included in Night package (code P55) and AMG Night package (code P60)	840	○	○	○	●	○	○	216.67	260.00
Safety and Assistance Systems										
Parking Pilot	Included in Executive, Premium or Premium Plus equipment line (code DP3, DP0 and DP1)	235	○	○	○	●	●	●	562.50	675.00

● Standard ○ Optional - Not available



Item	Notes		SE	Sport	AMG Line	Motorsport Edition	250 AMG	Mercedes-AMG A45 4MATIC	Basic RRP excl. VAT (£)	Total RRP incl. VAT (£)
Communications and In-Car Entertainment										
COMAND Online system ¹ Includes radio, Traffic Sign Assist, single CD/DVD, map navigation system with 3D map display, Live Traffic Information and European map data updates free of charge for the first three years, and LINGUATRONIC voice control. Mercedes me connect with standard and Remote Online services. Access to internet sites when vehicle is stationary, plus unrestricted use of Mercedes-Benz apps (internet-enabled mobile phone required) and in-car internet access for Facebook, internet radio, sending routes from Google Maps™ to the vehicle, news and weather reports. Also includes SD memory card slot	Only in conjunction with Executive, Premium or Premium Plus equipment line (code DP3, DP0 and DP1)	531	-	○	○	-	-	-	829.17	995.00
			-	-	-	○	○	○	829.17	995.00
DAB digital radio tuner		537	○	○	○	○	○	●	350.00	420.00
Garmin® MAP PILOT navigation system SD card navigation with instructions shown on media display and in the instrument cluster. SD card inserted in centre armrest compartment next to USB ports. Includes 3D views with exact visualisation of roads and buildings as well as junction and lane assistants making it easy for drivers to orient themselves. Operation via controller or voice control. Spoken instructions are emitted through the vehicle's built-in speakers. Software and maps can be updated via the internet	Included in Executive, Premium or Premium Plus equipment line (code DP3, DP0 and DP1)	357	○	○	○	●	●	●	412.50	495.00



Item	Notes	SE	Sport	AMG Line	Motorsport Edition	250 AMG	Mercedes-AMG A45 4MATIC	Basic RRP excl. VAT (£)	Total RRP incl. VAT (£)
Communications and In-Car Entertainment (continued)									
Surround sound system – Harman Kardon® Logic 7® with Dolby Digital 5.1 and DTS With 12 speakers, including a bass speaker, and a 9-channel DSP amplifier the audio system offers a perfect audio experience in stereo, in DTS and Dolby Digital 5.1 format	Included in Premium equipment line (code DP0) on Motorsport Edition, 250 AMG and Mercedes-AMG A 45 4MATIC	810	-	○	○	△	△	566.67	680.00
Mercedes me – Remote Online services On-board use of the remote and location services, e.g. geographic vehicle monitoring, vehicle location, remote door locking and unlocking, remote interrogation of vehicle status. Remote Online subscription services are limited to three years from initial registration, and can be extended at additional cost	Standard with COMAND Online system (code 531)	11U	○	○	○	○	○	125.00	150.00
Service Package									
Service Care Service Care allows you to spread the cost of servicing your new car in the Mercedes-Benz Retailer network. Taking out a Service Care plan ensures your servicing needs are taken care of by fully trained Mercedes-Benz Technicians with the added benefit of a Mercedes-Benz service history	Price is based on a monthly rate. Example given is for two services taken over 24 months, three services over 36 months or four services over 48 months. Further payment options are available. New Service Care prices apply only to vehicles up to 12 months old prior to first service. Prices correct up to 30 April 2016	1	○	○	○	○	-	20.00	24.00
			-	-	-	-	○	30.00	36.00



Genuine Accessories

We've developed a range of Accessories you can add to help personalise and enhance your A-Class. Your local Mercedes-Benz Retailer can advise on fitting costs of Accessories, where applicable. Further information on our full range of Genuine Accessories can be found on the Mercedes-Benz UK website.



01 | Shallow boot tub

The boot tub is suitable for transporting shopping. The tub shape with its slightly raised edge is precision-tailored to the load area. Made from impact-resistant, non-slip polypropylene. Structured surface holds separately available stowage crate in place. Deep boot tub also available.

Basic RRP £72.50 (excl. VAT) **Total RRP £87.00 (incl. VAT)**

02 | Stowage crate

A secure hold for items which are prone to tip over or slide around, e.g. shopping bags. Adjustable partitioning elements allow crate to be divided into max. four sections. Optimum functionality only in conjunction with shallow boot tub.

Basic RRP £71.67 (excl. VAT) **Total RRP £86.00 (incl. VAT)**



> View offers



Book a > test drive > AMG test drive



> Find a Retailer



> View the Range Guide



03 | All-season floor mats

Robust, washable synthetic material, designed for heavy use. Latest design with recessed areas and raised edge. With distinctive Mercedes-Benz star logo. Price for front and rear mats.

Basic RRP £73.34 (excl. VAT) **Total RRP £88.00 (incl. VAT)**



04 | Concertina load sill protector

Protects the rear of the car from scratches when you're loading the vehicle and prevents dirt on the car from getting onto your clothes. Practical design – can be connected to shallow boot tub or reversible mat.

Basic RRP £33.33 (excl. VAT) **Total RRP £40.00 (incl. VAT)**

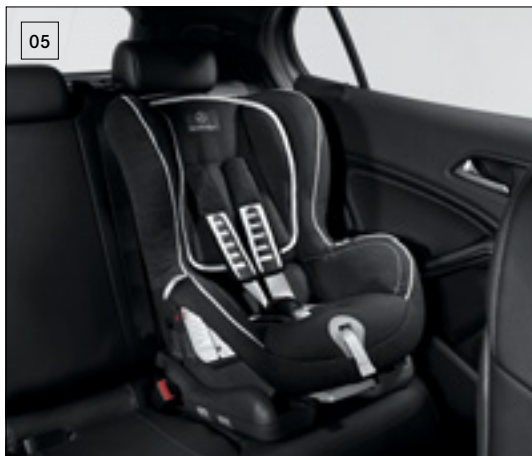

05 | DUO plus child seat, with ISOFIX and automatic child seat recognition

Optimum safety for children between the ages of around 8 months and 4 years (9 to 18 kg). Fitted as standard with top tether, an additional belt for securing the head section, a height-adjustable harness, ventilation channels and ISOFIX attachment points. With automatic child seat recognition. Adjustable tilt. Also available for ages 0+ (1 to 13 kg) and 3.5 to 12 years (15 to 36 kg).

Basic RRP £428.33 (excl. VAT) **Total RRP £449.75 (incl. VAT)**

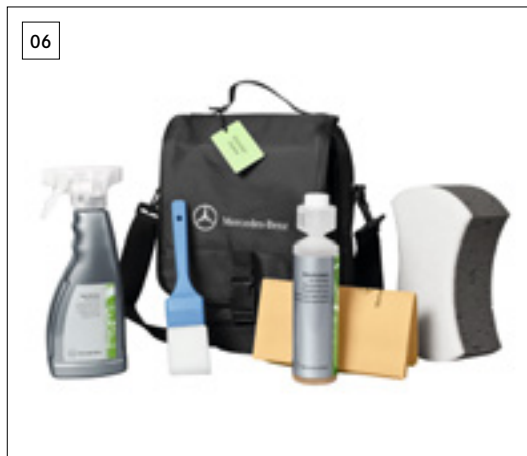

06 | Exterior Car Care Kit

The Mercedes-Benz Exterior Car Care Kit is a four-piece collection to keep the exterior of your car looking like it's come straight from the showroom. The bag contains car shampoo, wheel cleaner, sponge and polishing cloth.

Basic RRP £20.83 (excl. VAT) **Total RRP £25.00 (incl. VAT)**

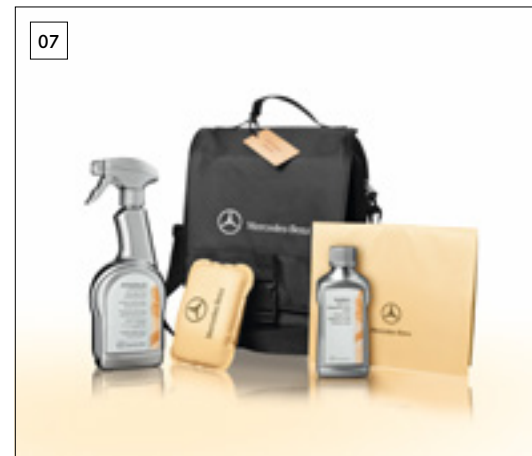

07 | Interior Car Care Kit

The Mercedes-Benz Interior Car Care Kit is a four-piece collection enabling you to maintain a spotless showroom finish inside your car. The bag contains cabin care spray, interior glass cleaner, interior glass sponge and car cloth.

Basic RRP £20.83 (excl. VAT) **Total RRP £25.00 (incl. VAT)**



08 | Winter wheels and tyres

16" alloy wheels (4) – 10-spoke design.

Basic RRP £950.04 (excl. VAT) **Total RRP £1,140.05 (incl. VAT)**



09 | Winter wheels and tyres

17" alloy wheels (4) – 5-twin-spoke design. Includes Tyre Pressure Monitor.

Basic RRP £1,289.16 (excl. VAT) **Total RRP £1,547.00 (incl. VAT)**

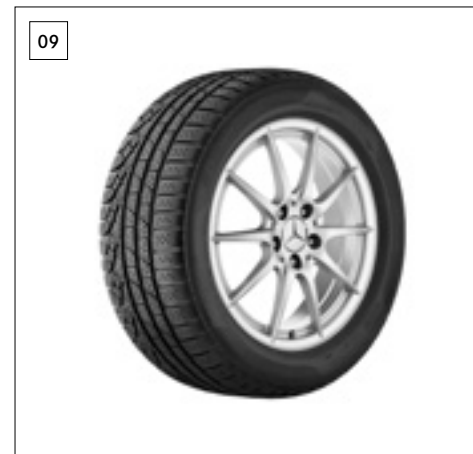

10 | Mercedes-Benz roof box, 400 litres

Multi-purpose box. Compact length, impressive amount of space. Capacity approx. 400 litres. Opens on both sides. Single lock system. Gas-filled struts for easy opening and closing of lid. Straps to hold contents in place. Maximum load capacity 75 kg. Available in matt silver or metallic black.

Basic RRP £341.67 (excl. VAT) **Total RRP £410.00 (incl. VAT)**



11 | Alustyle Quickfix carrier bars

Aluminium carrier bars, precision-tailored to the body of your A-Class – the perfect basis for a range of Mercedes-Benz transport solutions: ski and snowboard rack, bicycle rack or roof boxes.

Basic RRP £182.50 (excl. VAT) **Total RRP £219.00 (incl. VAT)**



Colours and materials

Non-metallic paints

Standard



589 jupiter red¹

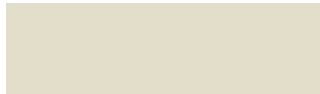

650 cirrus white

Metallic paints

Optional



162 south seas blue¹



761 polar silver



990 orient bronze¹



175 elbaite green¹



787 mountain grey

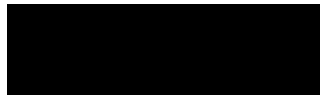

191 cosmos black



890 cavansite blue

Special metallic paint

Optional



662U designo mountain grey MAGNO²

¹Not available on Motorsport Edition ²Optionally available on Motorsport Edition, 250 AMG and Mercedes-AMG A45 4MATIC only

Please note that, owing to limitations of on-screen representation, paint colours may differ from those shown



> View offers



Book a > test drive > AMG test drive



> Find a Retailer



> View the Range Guide

Upholstery

SE/Sport

ARTICO leather¹



111 black²

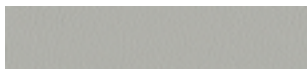

118 crystal grey²

Trim

SE



Honeycomb

Sport



Black chequerboard



Grey chequerboard

AMG Line/250 AMG/A45 4MATIC

ARTICO leather¹/
DINAMICA microfibre



651 black with red contrast stitching

AMG Line/250 AMG/A45 4MATIC



Carbon-fibre look

Motorsport Edition

Leather/DINAMICA microfibre



761 black with petrol green and grey stripes, and petrol green contrast stitching

Motorsport Edition



Carbon-fibre look

Exclusive package

(AMG Line/250 AMG/A45 4MATIC)
Leather



801 black



804 hazelnut brown



855 sahara beige/black

Exclusive package



Black perforated leather-look



Brown perforated leather-look

AMG Exclusive package

(AMG Line/250 AMG/A45 4MATIC)
Leather

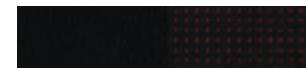

811 perforated black RED CUT

AMG Exclusive package



Carbon-fibre look

¹Man-made leather



Trim and upholstery combinations

	SE and Sport		AMG Line, 250 AMG and Mercedes-AMG A 45 4MATIC	Motorsport Edition
	ARTICO leather ¹		ARTICO leather ¹ /DINAMICA microfibre	Leather/DINAMICA microfibre
	black (111)	crystal grey (118)	black with red contrast stitching (651)	black with petrol green and grey stripes, and petrol green contrast stitching (761)
Dashboard				
Steering wheel	black	black	black	black
Upper dashboard trim	black	black	black	black
Lower dashboard trim	black	grey	black	black
Seats				
Seat cushion centre section	black	grey	black/red stitching	black/petrol green stitching
Side bolster trim	black	grey	black	black
Head restraint	black	grey	black	black
Seat belt	black	grey	black/red ²	black
Doors				
Lower door trim	black	black	black	black
Door pocket	black	grey	black	black
Roof lining	black ³ /grey	black ³ /grey	black	black
Floor covering				
Front and rear	black	black	black	black
Boot	black	black	black	black

¹Man-made leather ²Red seat belts on 250 AMG and Mercedes-AMG A 45 4MATIC ³Sport with Premium Plus equipment line (code DP1) only



> View offers



Book a > test drive > AMG test drive



> Find a Retailer



> View the Range Guide

Combination options

		ARTICO leather ¹ SE and Sport	black crystal grey	Leather/DINAMICA microfibre Motorsport Edition	black with petrol green and grey stripes, and petrol green contrast stitching	ARTICO leather/DINAMICA microfibre AMG Line, 250 AMG and A45 4MATIC	black with red contrast stitching	Leather (Exclusive package) AMG Line, 250 AMG and A45 4MATIC	black hazelnut brown sahara beige/black	Leather (AMG Exclusive package) AMG Line, 250 AMG and A45 4MATIC	perforated black RED CUT
Non-metallic paints (standard)											
	589 jupiter red	●	●	-	-	●	-	●	○	●	●
	650 cirrus white	●	●	●	●	●	●	●	●	●	●
Metallic paints (optional)											
	162 south seas blue	●	●	-	-	○	○	●	△	●	○
	175 elbaite green	●	●	-	-	○	○	●	△	△	○
	191 cosmos black	●	●	●	●	●	●	●	●	●	●
	761 polar silver	●	●	●	●	●	●	●	●	●	●
	787 mountain grey	●	●	●	●	●	●	●	●	●	●
	890 cavansite blue	●	●	-	-	●	●	●	●	●	●
	990 orient bronze	●	●	-	-	△	△	●	●	●	△
Special metallic paint (optional)											
	662U designo mountain grey MAGNO ²	-	-	●	●	●	●	●	●	●	●

● Recommended ○ Possible △ Not recommended - Not available ¹Man-made leather ²Optionally available on Motorsport Edition, 250 AMG and Mercedes-AMG A45 4MATIC only
Please note that, owing to limitations of on-screen representation, paint colours may differ from those shown



Technical data

Model	Diesel engines			Petrol engines												
	A 180 d	A 200 d	A 220 d [4MATIC]	A 160	A 180	A 200	A 250	A 250 4MATIC	A 45 4MATIC							
Engine																
Total displacement	cc	1,461	2,143	2,143	1,595	1,595	1,595	1,991	1,991	1,991						
Arrangement/cylinders/valves		in-line/4/8	in-line/4/16	in-line/4/16	in-line/4/16	in-line/4/16	in-line/4/16	in-line/4/16	in-line/4/16	in-line/4/16						
Power ¹	hp (kW) at rpm	109 (80)/4,000	136 (100)/3,200-4,000	177 (130)/3,600-3,800	102 (75)/4,500-6,000	122 (90)/5,000	156 (115)/5,300	218 (160)/5,500	218 (160)/5,500	381 (280)/6,000						
Torque ¹	Nm at rpm	260/1,750-2,500	300/1,400-3,000	350/1,400-3,400	180/1,200-3,500	200/1,250-4,000	250/1,250-4,000	350/1,200-4,000	350/1,200-4,000	475/2,250-5,000						
Transmission																
6-speed manual		●	●	-	●	●	●	●	-	-						
7G-DCT 7-speed automatic		○	○	●	○	○	○	○	-	-						
AMG SPEEDSHIFT DCT 7-speed sports transmission		-	-	-	-	-	-	-	●	●						
Performance																
		man.	auto.	man.	auto.	auto.	man.	auto.	man.	auto.	man.	auto.	man.	auto.	auto.	auto.
Acceleration 0-62 mph	sec	11.3	11.3	9.3	8.8	7.5 [7.5]	10.6	10.4	8.9	8.6	8.1	7.8	6.3	6.3	6.3	4.2
Top speed	mph	118		130		139 [137]	118		118		139		149		149	155 ²



Model	Diesel engines					Petrol engines									
	A 180 d	A 200 d	A 220 d [4MATIC]			A 160	A 180	A 200	A 250	A 250 4MATIC		A 45 4MATIC			
Weights and capacities	man.	auto.	man.	auto.	auto.	man.	auto.	man.	auto.	man.	auto.	man.	auto.	auto.	auto.
Kerb weight kg	1,395 ³	1,425	1,455	1,485	1,485 [1,545]	1,370	1,395	1,370	1,395	1,370	1,395	1,415	1,455	1,505	1,555
Perm. Gross Vehicle Weight kg	1,960 ³	1,960	2,010	2,010	2,010 [2,060]	1,935	1,935	1,935	1,935	1,935	1,935	1,960	1,960	2,030	2,050
Boot capacity – seats up seats down l	341 1,157	341 1,157	341 1,157	341 1,157	341 1,157	341 1,157	341 1,157	341 1,157	341 1,157	341 1,157	341 1,157	341 1,157	341 1,157	341 1,157	341 1,157
Towing capacity – unbraked braked kg	695 1,200 ⁴	710 1,200	725 1,500	740 1,500	740 [750] 1,500	685 1,200	695 1,200	685 1,200	695 1,200	685 1,400	695 1,400	730 1,500	730 1,500	750 1,500	– –
Fuel tank capacity/ of which reserve l	50/6 ³	50/6	50/6	50/6	50/6 [56/6]	50/6	50/6	50/6	50/6	50/6	50/6	50/6	50/6	56/6	56/8
Turning circle m	11.00	11.00	11.00	11.00	11.00	11.00	11.00	11.00	11.00	11.00	11.00	11.00	11.00	11.00	11.04
Fuel consumption^{5,6} mpg	man.	auto.	man.	auto.	auto.	man.	auto.	man.	auto.	man.	auto.	man.	auto.	auto.	auto.
SE															
Urban	65.7	65.7	51.4	58.9	–	39.2	42.2	37.7	41.5	–	–	–	–	–	–
Extra-urban ⁷	83.1	83.1	78.5	78.5	–	65.7	67.3	65.7	65.7	–	–	–	–	–	–
Combined	76.4	76.4	65.7	70.6	–	52.3	55.4	51.4	54.3	–	–	–	–	–	–
Sport															
Urban	62.8	65.7	49.6	57.7	–	39.2	41.5	37.2	40.9	40.9	37.2	–	–	–	–
Extra-urban ⁷	78.5	78.5	74.3	76.4	–	64.2	62.8	62.8	61.4	61.4	62.8	–	–	–	–
Combined	72.4	74.3	62.8	68.9	–	51.4	53.3	50.4	52.3	53.3	49.6	–	–	–	–

Model	Diesel engines					Petrol engines									
	A 180 d	A 200 d	A 220 d [4MATIC]			A 160	A 180		A 200		A 250		A 250 4MATIC	A 45 4MATIC	
Fuel consumption^{5,6} mpg	man.	auto.	man.	auto.	auto.	man.	auto.	man.	auto.	man.	auto.	man.	auto.	auto.	auto.
AMG Line/Motorsport Edition															
Urban	61.4	65.7	53.3	60.1	56.5 [49.6]	39.2	41.5	37.2	40.9	40.9	37.2	31.7	34.9	33.2	18"/19" wheels 30.7/29.4
Extra-urban ⁷	74.3	78.5	76.4	78.5	76.4 [65.7]	64.2	62.8	62.8	61.4	61.4	61.4	51.4	54.3	49.6	50.4/47.1
Combined	68.9	74.3	65.7	68.9	67.4 [58.9]	51.4	53.3	50.4	52.3	52.3	49.6	41.5	44.8	42.2	40.9/38.7

CO₂ emissions⁶ g/km	man.	auto.	man.	auto.	auto.	man.	auto.	man.	auto.	man.	auto.	man.	auto.	auto.	auto.
Emissions standard	EU6		EU6		EU6	EU6		EU6		EU6		EU6		EU6	EU6
16" alloy wheels (205/55 tyres)	89	98	106	99	-	124	119	127	121	-	-	-	-	-	-
17" alloy wheels (225/45 tyres)	102	101	111	103	-	126	124	131	126	132	126	-	-	-	-
18" alloy wheels (225/40 tyres)	102	101	111	103	107 [124]	126	124	131	126	132	124	-	-	-	-
18" alloy wheels (235/40 tyres)	-	-	-	-	-	-	-	-	-	-	-	158	145	156	162
19" alloy wheels (235/35 tyres)	-	-	-	-	-	-	-	-	-	-	-	158	145	156	171

Insurance

Group rating	13-14	17-18	22-23 [21-23]	tba	17-18	21-22	27-28	29	41
--------------	-------	-------	---------------	-----	-------	-------	-------	----	----

Insurance ratings may vary depending on model line and specification. Please refer to <http://www.thatcham.org/abigrouprating/> for further details

¹Figures according to Directive 80/1269/EEC in the currently applicable version ²Electronically limited ³A 180 d SE manual: kerb weight 1,385 kg; perm. GVW 1,850 kg; fuel tank capacity/reserve 40/61

⁴A 180 d SE manual: towing not possible ⁵All figures are based on a standard specification with the smallest tyre size ⁶The choice of wheels and transmission may affect CO₂ emissions and corresponding Road Fund Licence

⁷EUDC: extra-urban driving cycle. Testing procedures adhere to EU Directive 93/116



> View offers



Book a > test drive > AMG test drive



> Find a Retailer



> View the Range Guide

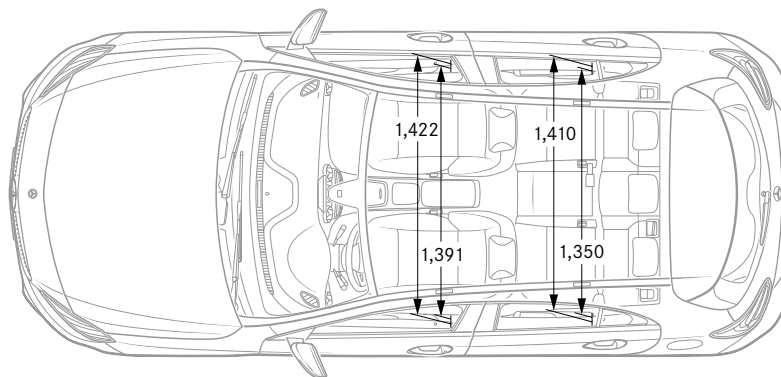
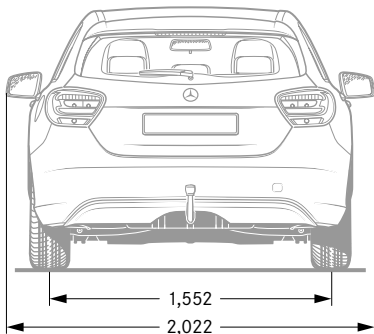
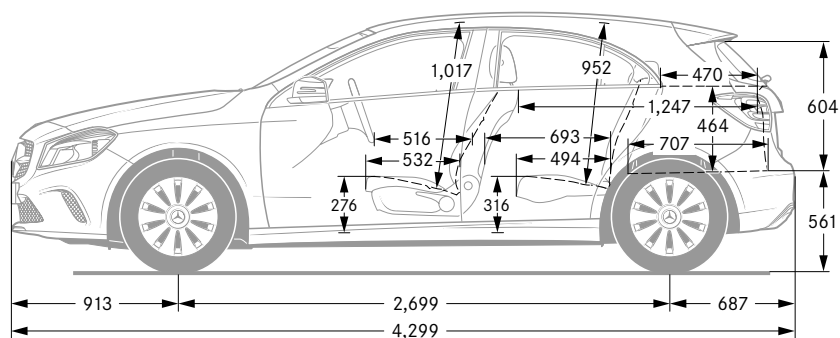
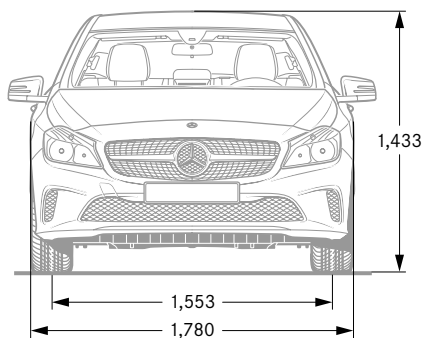



Road Fund Licence



All road vehicle registrations are subject to Vehicle Excise Duty (Road Fund Licence), which varies in accordance with the vehicle's CO₂ emissions. A first year rate of Vehicle Excise Duty applies to new cars on their first year of registration. For the second and subsequent years a standard rate for each taxation band will apply.¹ The table below shows the bands (A–M) created by the DVLA and the corresponding Road Fund Licence. CO₂ emissions are listed in the technical data on page 65, and the relevant Excise Duty is reflected in the on-the-road prices on pages 10–11.

Band	CO ₂ emissions	First year rate (£)	Standard rate (£)
A	up to 100 g/km	0.00	0.00
B	101 to 110 g/km	0.00	20.00
C	111 to 120 g/km	0.00	30.00
D	121 to 130 g/km	0.00	110.00
E	131 to 140 g/km	130.00	130.00
F	141 to 150 g/km	145.00	145.00
G	151 to 165 g/km	185.00	185.00
H	166 to 175 g/km	300.00	210.00
I	176 to 185 g/km	355.00	230.00
J	186 to 200 g/km	500.00	270.00
K	201 to 225 g/km	650.00	295.00
L	226 to 255 g/km	885.00	500.00
M	over 255 g/km	1,120.00	515.00

¹For further information on vehicle taxation please refer to <http://carfueldata.direct.gov.uk/>

Services and insurance

Mercedes-Benz Service Care

We believe that servicing costs should be as flexible and affordable as possible for your A-Class, which is why we offer Service Care, an easy way to budget for all your servicing costs. It spreads your bills into manageable payments based on whether you have a new or used Mercedes-Benz.

With Service Care we guarantee the price of parts and labour for up to four services and safeguard against any further inflation. It also covers the cost of any additional items including brake fluid, spark plugs, air filters, fuel filters and screen wash.

You can choose either to add your servicing costs into your monthly spend or pay the full amount in a one-off payment, giving you peace of mind that they are taken care of for the period of the plan.

To receive a personalised Service Care plan recommendation visit the Service Care Calculator at servicecarerates.mercedes-benz.co.uk

Warranty and breakdown cover

Every Mercedes-Benz comes with a three-year unlimited mileage warranty against manufacturing or material defects¹ and up to 30 years warranty against perforation due to corrosion from the inside out.² What's more, it's also covered by Mercedes-Benz Roadside Assistance – a unique package comprising up to 30 years pan-European breakdown assistance.²

Insurance

Since our name is synonymous with reliability, who better to trust with your motor insurance? Mercedes-Benz Insurance provides a motor insurance policy specifically designed to give you the cover you would expect from Mercedes-Benz. For a motor insurance quotation, call **0345 600 2180**.*



> View offers



Book a > test drive > AMG test drive



> Find a Retailer



> View the Range Guide

The Mercedes that thinks and acts for you.

Imagine if...

...you could connect with your Mercedes-Benz?

With Mercedes me connect, you can; with Remote Online services¹ that include trip planning, maintenance management and vehicle tracking, plus more.

Getting connected is easy. Just set up your Mercedes me account and get in touch with your Mercedes-Benz Retailer to connect your vehicle to your profile to access your Mercedes me connect services.

...you knew beforehand that you need to stop for fuel?

Simply check the fuel level and mileage range from your phone wherever you are. You can also check tyre pressure and washer fluid level. (For electric cars, you can check battery charge state.)

...your Mercedes could tell you where it's parked?

You no longer need to ask yourself where you left your car; with Mercedes me connect you can locate your car from your smartphone or tablet within a mile radius.



1. PARKED VEHICLE LOCATOR
2. VEHICLE TRACKER

3. REMOTE RETRIEVAL OF VEHICLE STATUS
4. PRE-ENTRY CLIMATE CONTROL FOR ELECTRIC DRIVE AND PLUG-IN HYBRID



> View offers



Book a > test drive > AMG test drive



> Find a Retailer



> View the Range Guide

...you could lock your Mercedes, even if you're miles away?

The uncertainty of whether you've forgotten to lock the car is only human. To make sure your Mercedes-Benz is safe and secure, you can simply lock the car remotely via your PC/Mac, tablet or smartphone.

...your Mercedes told you when your service is due?

Being connected means essential data is constantly sent to your Mercedes-Benz Retailer so they know when it is time for a service. Your Retailer can then contact you with a tailor-made service quote.

...your Retailer already knows which parts need replacing?

As surprising as this sounds, with teliagnostics your Retailer can recognise remotely if certain parts are due for replacement, contacting you to book an appointment and making sure the relevant parts are in stock when you arrive, getting you back on the road as quickly as possible.

...you could just push a button to deal with a breakdown?

Should your car break down, with a simple press of the button everything is taken care of – from breakdown assistance to vehicle recovery.

...your Mercedes called for help?

Your Mercedes comes with an SOS button. Press it if you need urgent help and you will be contacted by the emergency response centre.² In the event of an accident where airbags or seatbelt tensioners have been activated, a call is placed automatically. Your GPS position is sent to the response teams to initiate rescue efforts.³

The Mercedes that thinks and acts for you.

Contact your Retailer to get connected, or go to www.mercedes.me for more details.

¹This is available as an option in conjunction with Audio20 CD, and standard with COMAND Online. Remote Online is standard with electric drive and plug-in hybrid. Use of the Remote Online equipment option is limited to three years from first registration of the vehicle and can then be extended at extra cost.

²A call is placed via the car's sim card, rather than the customer relying on their mobile phone.

³This feature is still available to customers without Mercedes me connect services. The customer is not required to accept the terms and conditions on the portal to activate this feature. For all other features the customer will have to accept terms and conditions on the portal to activate them.

Mercedes-Benz Finance

Why should you finance with Mercedes-Benz?

At Mercedes-Benz we believe a great driving experience should be matched by an equally great ownership experience. That is why we put just as much thought, time and effort into designing our finance options, our service plans and our insurance cover as we do into our vehicles.

We are not in the business of simply providing a loan to fund the purchase of your dream vehicle. We look on it as a journey that we take with you, from the moment you choose your new Mercedes-Benz, to helping you in choosing your next one.

If you would like to find out more about any of our current offers, simply call into your local Mercedes-Benz Retailer where one of our Business Managers will be more than happy to talk you through anything you need to know.

Helping you find the right solution.

You should find our finance packages are more convenient than a traditional personal loan because:

- Funds are immediately available – no waiting for cheques or loans to clear.
- There is no security required – either against your home or other assets.
- We have clear and transparent rates – the APR we quote is the APR you get.
- We have friendly Business Managers – experts in vehicle finance who can talk you through all of your plans in detail.

One of our most popular finance products is Mercedes-Benz Agility (our Personal Contract Purchase product). We also offer Contract Hire, Operating Lease and Hire Purchase solutions. If you would like to find out more about these speak to your Retailer or visit www.mercedes-benz.co.uk/fandi.

Mercedes-Benz Agility (our PCP product).

At the start of an Agility agreement, you put down a deposit and decide the term of your agreement and your annual mileage. You will be advised of the Guaranteed Future Value, which offers you the reassurance of knowing exactly what you will need to pay to own the vehicle outright in the future (this is known as the Optional Purchase Payment).

Throughout your agreement you simply pay your agreed monthly payments and when the agreement comes to an end you either purchase, hand back or part-exchange your vehicle.





Agility features:

- Fixed regular payments mean you can easily budget.
- Payments are based only on a proportion of the vehicle's value, keeping your monthly payments lower.
- Our Guaranteed Future Value avoids the risk of unplanned depreciation of your vehicle.
- You defer your ownership decision until the end of the agreement.

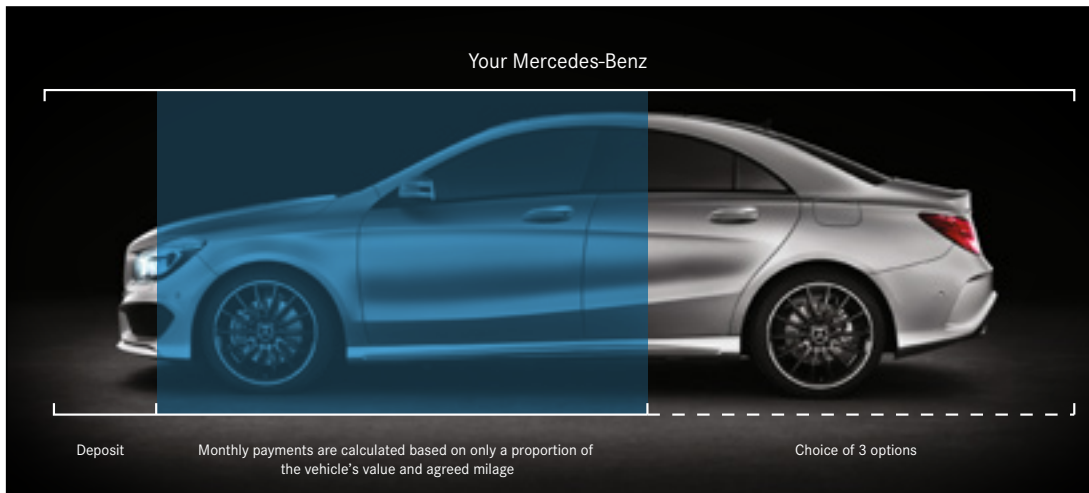

At the end of your agreement you have three options to choose from.

Option 1: Purchase your Mercedes-Benz.

Purchase your Mercedes-Benz by paying the Optional Purchase Payment and Purchase Activation Fee.¹ This will complete the purchase of your Mercedes-Benz, leaving you free to simply enjoy your vehicle.

Option 2: Hand back your Mercedes-Benz.

If you decide to return your vehicle to us, it must be in line with our Vehicle Return Standards,* as vehicle condition, excess mileage and other charges may be payable.

Option 3: Part-Exchange for a new vehicle.

Purchase your Mercedes-Benz by paying the Optional Purchase Payment and Purchase Activation Fee.¹ This will complete the purchase of your Mercedes-Benz, leaving you free to part-exchange for a new vehicle.

¹Please note the 'Purchase Activation Fee' of £10 will be debited from your account *To find out more information about our Vehicle Return Standards please visit <http://mercedes-benz.co.uk/vrs>



> View offers



Book a > test drive > AMG test drive



> Find a Retailer



> View the Range Guide

Follow us on the following social media channels:



<https://www.facebook.com/MercedesBenzUk>



<https://twitter.com/mercedesbenzUK>



<https://www.youtube.com/mercedesbenzUK>



<https://instagram.com/mercedesbenzUK>

Effective from 14 April 2016. Information correct at time of publication.

Prices and specifications are subject to change without prior notice.

MBW 176PL/0416

Mercedes-Benz UK Ltd, Tongwell, Milton Keynes, MK15 8BA www.mercedes-benz.co.uk