



> View offers



> Book a test drive



> Find a Retailer



> View the Range Guide

# C-Class Coupé



Effective from 1 April 2016.

Mercedes-Benz



# Contents

Model prices	8	Mercedes-AMG driver training	27	Colours and materials	46
Finance offers	10	Pricing summary for Premium and Premium Plus equipment lines	29	Technical data	50
Model lines	14	Standard equipment	30	Road Fund Licence	54
Premium and Premium Plus equipment lines	18	Wheels	35	Services and insurance	55
Mercedes-AMG models	20	Driving Assistance package	38	Mercedes me	56
Premium and Premium Plus equipment lines for Mercedes-AMG	26	Optional equipment	39	Mercedes-Benz Finance	58

## The hard facts to melt your heart

At Mercedes-Benz we appreciate the importance of detail. Over the following pages you'll find model prices and a breakdown of standard and optional equipment, as well as details of the comprehensive services and benefits that are available to every Mercedes-Benz driver.

See Mercedes-Benz in a new light. Now is the time to get yourself behind the wheel of a C-Class. Choose from a number of attractive finance offers. Please see pages 10–13 for further details, or visit [www.mercedes-benz.co.uk/offers](http://www.mercedes-benz.co.uk/offers)

Of course, some things have to be experienced to be truly appreciated, such as the qualities that set a Mercedes-Benz apart. Which is why we'd like to invite you for a test drive at your local Mercedes-Benz Retailer. Alternatively, you can make arrangements by visiting [www.mercedes-benz.co.uk/testdrive](http://www.mercedes-benz.co.uk/testdrive)

For more information visit [www.mercedes-benz.co.uk](http://www.mercedes-benz.co.uk) or call 0333 222 0500.



> View offers



> Book a test drive



> Find a Retailer



> View the Range Guide



Some of the model features, optional extras and colours shown may not be available, or may only be available in a different specification.





> View offers



> Book a test drive



> Find a Retailer



> View the Range Guide



Some of the model features, optional extras and colours shown may not be available, or may only be available in a different specification.



> View offers



> Book a test drive



> Find a Retailer



> View the Range Guide







> View offers



> Book a test drive



> Find a Retailer



> View the Range Guide



# Model prices

Engine	Model line	Transmission	CO <sub>2</sub>	Basic RRP excl. VAT (£)	Total RRP incl. VAT (£)	Road Fund Licence (£) <sup>1</sup>	Rec. OTR price (£) <sup>2</sup>	P11D value (£)	BiK tax rate 2016/17 (%)
<b>C220 d</b> Diesel – 2,143 cc, 4-cylinder, 170 hp/125 kW	Sport	6-speed manual <sup>3</sup>	106	27,329.17	32,795.00	0.00	33,465.00	33,410.00	21
		9G-TRONIC PLUS 9-speed automatic <sup>3</sup>	106	28,579.17	34,295.00	0.00	34,965.00	34,910.00	21
	AMG Line	6-speed manual <sup>3</sup>	113	28,575.00	34,290.00	0.00	34,960.00	34,905.00	22
		9G-TRONIC PLUS 9-speed automatic <sup>3</sup>	109	29,825.00	35,790.00	0.00	36,460.00	36,405.00	21
<b>C250 d</b> Diesel – 2,143 cc, 4-cylinder, 204 hp/150 kW	Sport	9G-TRONIC PLUS 9-speed automatic <sup>3</sup>	109	29,541.67	35,450.00	0.00	36,120.00	36,065.00	21
	AMG Line	9G-TRONIC PLUS 9-speed automatic <sup>3</sup>	112	30,787.50	36,945.00	0.00	37,615.00	37,560.00	22
<b>C200</b> Petrol – 1,991 cc, 4-cylinder, 184 hp/135 kW	Sport	6-speed manual <sup>3</sup>	123	25,237.50	30,285.00	0.00	30,955.00	30,900.00	21
		7G-TRONIC PLUS 7-speed automatic <sup>3</sup>	125	26,487.50	31,785.00	0.00	32,455.00	32,400.00	22
	AMG Line	6-speed manual <sup>3</sup>	132	26,483.33	31,780.00	130.00	32,580.00	32,395.00	23
		7G-TRONIC PLUS 7-speed automatic <sup>3</sup>	133	27,733.33	33,280.00	130.00	34,080.00	33,895.00	23

<sup>1</sup>A different first year rate of Vehicle Excise Duty (Road Fund Licence) applies for new cars. Please refer to page 54 for the relevant rate for the second and subsequent years

<sup>2</sup>Recommended on-the-road price: these prices reflect the Road Fund Licence applicable to the standard model plus £670.00 additional costs necessary to put your car on the road.

Included are a standard UK delivery charge (£540.00 incl. VAT), new vehicle registration fee (£55.00), number plates (£25.00 incl. VAT) and fuel (£50.00 incl. VAT). VAT is calculated at the standard rate of 20%

<sup>3</sup>With ECO start/stop



Engine	Model line	Transmission	CO <sub>2</sub>	Basic RRP excl. VAT (£)	Total RRP incl. VAT (£)	Road Fund Licence (£) <sup>1</sup>	Rec. OTR price (£) <sup>2</sup>	P11D value (£)	BiK tax rate 2016/17 (%)
<b>C300</b> Petrol – 1,991 cc, 4-cylinder, 245 hp/180 kW	Sport	7G-TRONIC PLUS 7-speed automatic <sup>3</sup>	146	28,870.83	34,645.00	145.00	35,460.00	35,260.00	26
	AMG Line	7G-TRONIC PLUS 7-speed automatic <sup>3</sup>	154	30,116.67	36,140.00	185.00	36,995.00	36,755.00	27
<b>Mercedes-AMG</b>									
<b>Mercedes-AMG C 63</b> Petrol – 3,982 cc, 8-cylinder, 476 hp/350 kW	-	AMG SPEEDSHIFT MCT 7-speed auto. <sup>3</sup>	200	50,000.00	60,000.00	500.00	61,170.00	60,615.00	37
<b>Mercedes-AMG C 63 S</b> Petrol – 3,982 cc, 8-cylinder, 510 hp/375 kW	-	AMG SPEEDSHIFT MCT 7-speed auto. <sup>3</sup>	200	55,758.33	66,910.00	500.00	68,080.00	67,525.00	37
<b>Mercedes-AMG C 63 S Edition 1</b> Petrol – 3,982 cc, 8-cylinder, 510 hp/375 kW	-	AMG SPEEDSHIFT MCT 7-speed auto. <sup>3</sup>	200	63,116.67	75,740.00	500.00	76,910.00	76,355.00	37

<sup>1</sup>A different first year rate of Vehicle Excise Duty (Road Fund Licence) applies for new cars. Please refer to page 54 for the relevant rate for the second and subsequent years

<sup>2</sup>Recommended on-the-road price: these prices reflect the Road Fund Licence applicable to the standard model plus £670.00 additional costs necessary to put your car on the road.

Included are a standard UK delivery charge (£540.00 incl. VAT), new vehicle registration fee (£55.00), number plates (£25.00 incl. VAT) and fuel (£50.00 incl. VAT). VAT is calculated at the standard rate of 20%

<sup>3</sup>With ECO start/stop

# Mercedes-Benz Finance

As you'd expect with models of efficiency, the repayments aren't excessive



## C 200 Sport Coupé with optional metallic paint (representative example)

36 monthly payments of <sup>1</sup>	£329.00
Customer deposit	£4,999.00
On-the-road price	£31,600.00
Retailer deposit contribution	£2,655.36
Optional purchase payment <sup>2</sup>	£15,275.00
Amount of credit	£23,945.64
Duration of agreement	36 months
Total amount payable <sup>3</sup>	£34,783.36
Purchase activation fee <sup>2</sup>	£10.00
APR	5.5%
Fixed interest rate	5.33%
Excess mileage	10p per mile

**Example offers –  
5.5% APR Representative**

	Automatic	Metallic	On-the-road price	Customer deposit	36 monthly payments of <sup>1</sup>
C200 AMG Line Coupé	–	○	£33,225.00	£5,043.50	£349.00
C220d AMG Line Coupé	○	○	£37,105.00	£6,179.77	£379.00

● Standard equipment ○ Optional equipment included in the price

### Mercedes-Benz Service Care

- Mercedes-Benz trained Technicians
- Maintained by Mercedes-Benz Retailers
- Meets requirements of Mercedes-Benz Agility finance agreement

### Mercedes-Benz Motor Insurance

- 24/7 UK accident recovery
- We use Mercedes-Benz GenuineParts
- To qualify for up to 10% discount online, go to [www.mercedes-benz.co.uk/motorinsurance](http://www.mercedes-benz.co.uk/motorinsurance)
- Alternatively, call Mercedes-Benz Motor Insurance now on **0345 600 2180<sup>4</sup>** for an annual quote

We may decline to quote in some circumstances. Mercedes-Benz Motor Insurance is underwritten by Aviva Insurance Limited

Content relating to finance is promoted by Mercedes-Benz Finance. Your Retailer may offer finance on behalf of other companies.

Orders/credit approvals on selected C-Class Coupé models only, between 1 April and 30 June 2016, registered by 30 September 2016; excluding Mercedes-AMG C63 models. Some combinations of features/options may not be available.

Please contact your local Mercedes-Benz Retailer for availability

<sup>1</sup>Based on a Mercedes-Benz Agility agreement. Vehicle condition, excess mileage and other charges may be payable. Quotations available on request for alternative contract lengths and mileages.

Guarantees may be required. Credit provided subject to status by Mercedes-Benz Finance, MK15 8BA

<sup>2</sup>Payable if you exercise the option to purchase the car

<sup>3</sup>Includes optional purchase payment, purchase activation fee and Retailer deposit contribution (where applicable) <sup>4</sup>Calls are charged at local rate and may be recorded



# Mercedes-Benz Finance

As you'd expect with models of efficiency, the repayments aren't excessive

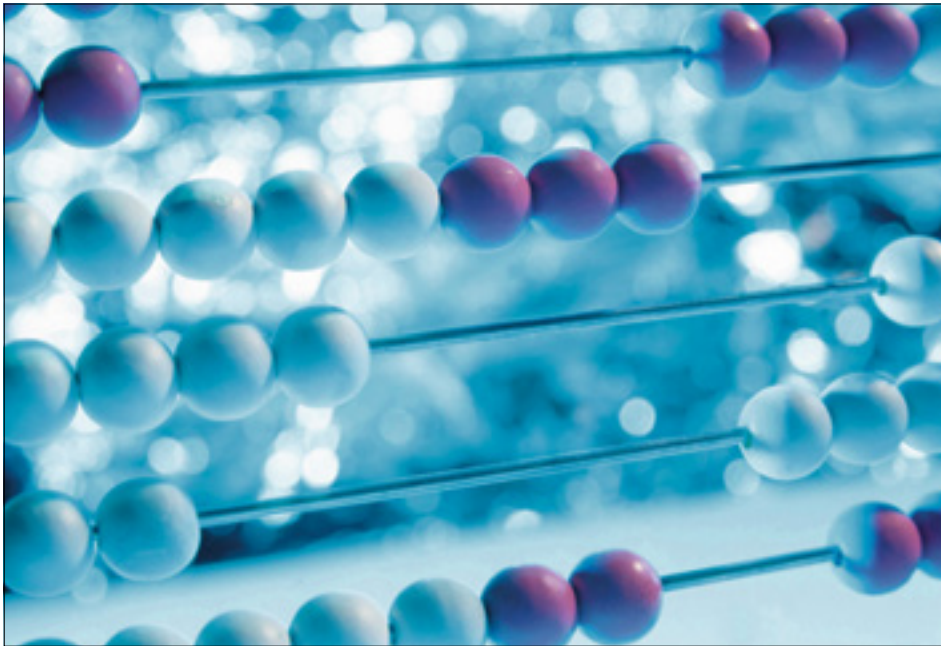

## Mercedes-AMG C 63 Coupé with optional metallic paint (representative example)

36 monthly payments of <sup>1</sup>	£849.00
Customer deposit	£8,501.32
On-the-road price	£61,815.00
Optional purchase payment <sup>2</sup>	£30,375.00
Amount of credit	£53,313.68
Duration of agreement	36 months
Total amount payable <sup>3</sup>	£69,450.32
Purchase activation fee <sup>2</sup>	£10.00
APR	6.2%
Fixed interest rate	5.98%
Excess mileage	15p per mile

**Example offers –  
6.2% APR Representative**

	Automatic	Metallic	On-the-road price	Customer deposit	36 monthly payments of <sup>1</sup>
Mercedes-AMG C 63 Coupé	●	○	£61,815.00	£8,501.32	£849.00

● Standard equipment ○ Optional equipment included in the price

**Mercedes-Benz Service Care**

- Mercedes-Benz trained Technicians
- Maintained by Mercedes-Benz Retailers
- Meets requirements of Mercedes-Benz Agility finance agreement

**Mercedes-Benz Motor Insurance**

- 24/7 UK accident recovery
- We use Mercedes-Benz GenuineParts
- To qualify for up to 10% discount online, go to [www.mercedes-benz.co.uk/motorinsurance](http://www.mercedes-benz.co.uk/motorinsurance)
- Alternatively, call Mercedes-Benz Motor Insurance now on **0345 600 2180<sup>4</sup>** for an annual quote

We may decline to quote in some circumstances. Mercedes-Benz Motor Insurance is underwritten by Aviva Insurance Limited

Content relating to finance is promoted by Mercedes-Benz Finance. Your Retailer may offer finance on behalf of other companies.

Orders/credit approvals on selected Mercedes-AMG C 63 Coupé models only, between 1 April and 30 June 2016, registered by 30 September 2016; excluding non-Mercedes-AMG models. Some combinations of features/options may not be available.

Please contact your local Mercedes-Benz Retailer for availability

<sup>1</sup>Based on a Mercedes-Benz Agility agreement. Vehicle condition, excess mileage and other charges may be payable. Quotations available on request for alternative contract lengths and mileages.

Guarantees may be required. Credit provided subject to status by Mercedes-Benz Finance, MK15 8BA

<sup>2</sup>Payable if you exercise the option to purchase the car

<sup>3</sup>Includes optional purchase payment, purchase activation fee and Retailer deposit contribution (where applicable) <sup>4</sup>Calls are charged at local rate and may be recorded



> View offers



> Book a test drive



> Find a Retailer



> View the Range Guide

# C-Class Sport





From the long bonnet to the sculpted rear, the new C-Class Coupé is filled with athletic credentials. The Sport features 17" alloy wheels, 15 mm lowered AGILITY CONTROL comfort suspension and DYNAMIC SELECT to adjust the suspension to your driving style. The interior mirrors an equally strong emphasis on sportiness and advanced technology. For ultimate comfort,

driver and front passenger enjoy heated integral sports seats featuring a Seat Comfort package. Its electro-pneumatic four-way lumbar support helps you savour every corner. Top-end technology also comes as standard, courtesy of the Garmin® MAP PILOT navigation system, the touchpad with multi-touch control and Active Parking Assist including PARKTRONIC.

#### Exterior

Mirror package – electrically folding mirrors and automatically dimming exterior driver's mirror and rear-view mirror

17" alloy wheels – 5-twin-spoke design

Active Parking Assist including PARKTRONIC

AGILITY CONTROL comfort suspension – lowered by 15 mm

COLLISION PREVENTION ASSIST PLUS

Direct-Steer speed-sensitive steering

DYNAMIC SELECT with a choice of five driving modes

Headlamps – LED High Performance headlamps with integral LED daytime running lamps

Rain-sensing windscreen wipers

Reversing camera

SPEEDTRONIC cruise control

Tyre pressure monitoring system

#### Interior

Seat Comfort package – driver and front passenger seat  
Electro-pneumatic four-way lumbar support and manual seat cushion depth adjustment (6 cm)

Audio 20 CD with 7-inch colour display

Black steering wheel gearshift paddles (auto. transmission only)

DAB digital radio tuner

Double cup holder

Heated front seats

Integral sports seats with ARTICO leather<sup>1</sup> upholstery

Media Interface

Garmin® MAP PILOT navigation system

Rear seats – split folding

Steering wheel – 3-spoke multi-function steering wheel, trimmed in leather

Touchpad with multi-touch control

#### Trim and Upholstery

High-gloss black with brushed aluminium



ARTICO leather<sup>1</sup> – black



ARTICO leather<sup>1</sup> – crystal grey

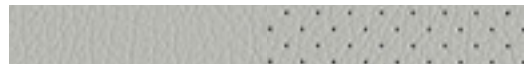

ARTICO leather<sup>1</sup> – saddle brown



ARTICO leather<sup>1</sup> – silk beige



<sup>1</sup>Man-made leather



> View offers



> Book a test drive



> Find a Retailer



> View the Range Guide

## C-Class AMG Line



Optional metallic paint finish shown

The AMG Line boasts many distinguishing AMG exterior features. They range from the eye-catching diamond grille with integrated star and chrome pins, to AMG bodystyling and visible twin-pipe exhausts, integrated into the rear bumper. You'll also notice 5-spoke 18" AMG alloy wheels painted in titanium grey and perforated front brake discs. Meanwhile, sports suspension and Sports Direct-Steer with speed-sensitive steering ensure excellent on-road

performance. The interior reveals integral sports seats and black floor mats with 'AMG' lettering. For a truly sporty driving sensation, there are AMG sports pedals in brushed stainless steel and a 3-spoke multi-function AMG steering wheel in black leather. For more advanced technology at your fingertips, the Audio 20 CD including a touchpad for access to the integrated Media Interface comes as standard.

#### Exterior

- 18" AMG alloy wheels – 5-spoke design, painted titanium grey
- AMG bodystyling – front apron, rear apron and side skirts
- Sports braking system with perforated front brake discs
- Sports Direct-Steer system with speed-sensitive steering
- Sports suspension

#### Interior

- AMG sports pedals in brushed stainless steel with rubber studs
- Floor mats – black with 'AMG' lettering
- Roof liner – black
- Silver steering wheel gearshift paddles (automatic transmission only)
- Steering wheel – 3-spoke multi-function AMG steering wheel in black leather with flattened bottom section, chrome inserts and perforated leather in grip area

#### Trim and Upholstery

Black ash wood with brushed aluminium



ARTICO leather<sup>1</sup> – black



ARTICO leather<sup>1</sup> – crystal grey

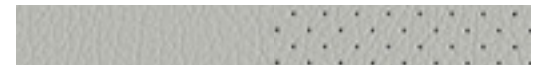

ARTICO leather<sup>1</sup> – saddle brown



ARTICO leather<sup>1</sup> – silk beige



<sup>1</sup>Man-made leather



## Premium and Premium Plus equipment lines



Ambient lighting



KEYLESS-GO Comfort package



Memory package



Panoramic glass sunroof



Burmester® surround sound system



COMAND Online system

Why not enhance and personalise your choice of new car? If you want to increase your comfort and add the best in entertainment to the Sport and AMG Line, the Premium equipment lines do just that. The Premium equipment line features ambient lighting; the KEYLESS-GO Comfort package for effortless entry, exit and starting; the Memory package for the front seats; and a panoramic glass sunroof to brighten up the cabin.

The Premium Plus equipment line contains the same features as the Premium equipment line, plus the highly sophisticated Burmester® surround sound system and COMAND Online<sup>1</sup> with an 8.4-inch high-resolution colour display, navigation with 3D map display and internet connectivity. Both the Premium and Premium Plus equipment lines are only available with automatic transmission.

Item	Notes	Premium £1,695.00 <sup>2</sup> (code DP0)	Premium Plus £2,995.00 <sup>2</sup> (code DP1)
Ambient lighting	LED lighting located in door trim, side of centre console, front door sills, cup holders, footwells, door handle recesses and overhead panel. Five dimming levels and three colours: solar (amber), polar (ice blue) and neutral (white)	■	■
KEYLESS-GO Comfort package	Offering hands-free access, automatic powered boot closing, keyless entry and keyless start. Includes chrome trim on top half of door handles	■	■
Memory package	Driver's seat, front passenger seat, steering column and exterior mirrors – electrically adjustable with memory	■	■
Panoramic glass sunroof	Consisting of a fixed panoramic glass rear section and an electrically operated sliding glass front section, the glass roof provides additional light and ventilation into the car	■	■
Burmester® surround sound system	13 speakers and a 9-channel amplifier with total output of 590 W (7 × 50 W and 2 × 120 W)	–	■
COMAND Online system <sup>1</sup>	8.4-inch high-resolution colour display, hard disk drive (HDD) navigation with 3D map display, Live Traffic Information and European map data updates free of charge for the first three years. Single CD/DVD, Speed Limit Assist and LINGUATRONIC voice control. Mercedes me connect services, emergency call system (eCall) and access to internet sites when vehicle is stationary, plus unrestricted use of Mercedes-Benz apps (internet-enabled mobile phone required). Integrated WLAN hotspot for onboard access of WLAN-enabled devices. Also includes 10 GB music register and MP3 compatibility	–	■



> View offers



> Book a test drive



> Find a Retailer



> View the Range Guide

## Mercedes-AMG C 63





The new Mercedes-AMG C 63 spells power and ambition in its unmistakable way. It features unique 18" AMG 5-spoke alloy wheels and AMG bodystyling with a front apron and splitter in body colour. The AMG Performance exhaust system points to the thrilling V8 engine. For an equally bold statement, the interior is fitted with AMG sports seats clad in nappa leather and combined with a high-gloss black trim with brushed aluminium. The 3-spoke multi-

function AMG performance steering wheel also comes with nappa leather to guarantee a tactile sporty experience. Whenever you're on the road, LED High Performance headlamps with integral LED daytime running lamps help ensure optimum visibility. All the while, you stay in complete control with the AMG instrument cluster and enjoy sophisticated comfort and entertainment features like the COMAND Online multimedia system<sup>1</sup> and ambient lighting.

#### Exterior

18" AMG 5-spoke alloy wheels, painted titanium grey with high-sheen finish

AMG bodystyling – front apron and splitter in body colour, bonnet, side skirts, fenders and rear diffuser-style apron design

AMG boot lid spoiler in body colour

AMG mechanical rear axle differential lock

AMG Performance exhaust system

Anti-lock braking system (ABS)

Brake calipers – silver with 'AMG' lettering

Headlamps – LED High Performance headlamps with integral LED daytime running lamps

SPEEDTRONIC cruise control with variable speed limiter

'V8 BITURBO' lettering on front wings

#### Interior

Memory package

Ambient lighting – five dimming levels and three colours

AMG instrument cluster

AMG sports seats with nappa leather upholstery

COMAND Online system<sup>1</sup>

Rear seats – split folding 40:20:40

Seat belts – black

Steering wheel – 3-spoke multi-function AMG performance steering wheel in nappa leather

#### Trim and Upholstery

High-gloss black with brushed aluminium



Nappa leather – black



Nappa leather – platinum white



Nappa leather – red pepper



<sup>1</sup>COMAND Online functionality and Wi-Fi connectivity is dependent on a compatible cellular data connection. Please check with your local Mercedes-Benz Retailer on network compatibility



> View offers



> Book a test drive



> Find a Retailer



> View the Range Guide

# Mercedes-AMG C 63 S



Mercedes-AMG C 63 S: designo iridium silver magno (code 982), 19"/20" AMG cross-spoke forged wheels (code 767), AMG Night package (code P60), AMG Exterior Carbon Fibre package 1 (code 773), AMG Exterior Carbon Fibre package 2 (code B28), LED Intelligent Light System (code 642)

The letter S points to the even greater physical prowess and individual style of the Mercedes-AMG C 63 S. While the engine delivers 34 hp (25 kW) more than the Mercedes-AMG C 63, this model also boasts 5-twin-spoke 19" AMG alloy wheels and AMG bodystyling featuring a front apron with splitter in silver shadow. To suit a more dynamic driving style, AMG electronic rear axle differential locks are fitted as standard. The interior reflects this sporty

persona with nappa leather in a choice of three upholstery colours on AMG Performance seats. You'll also find nappa leather combined with DINAMICA microfibre adorning the 3-spoke multi-function AMG performance steering wheel. For all your multimedia needs, there is the COMAND Online system<sup>1</sup> and a high-resolution 8.4-inch colour display.

#### Exterior

- 19" AMG 5-twin-spoke alloy wheels, painted titanium grey with high-sheen finish
- AMG bodystyling – front apron in high-gloss black with splitter in silver shadow, bonnet, side skirts, fenders and rear diffuser-style apron design
- AMG boot lid spoiler in body colour
- AMG electronic rear axle differential lock
- AMG Performance exhaust system
- Anti-lock braking system (ABS)
- Brake calipers – red
- Headlamps – LED High Performance headlamps with integral LED daytime running lamps
- SPEEDTRONIC cruise control with variable speed limiter
- 'V8 BITURBO' lettering on front wings

#### Interior

- Memory package
- AMG instrument cluster
- AMG Performance seats
- Ambient lighting – five dimming levels and three colours
- COMAND Online system<sup>1</sup>
- Mercedes-AMG C 63 S badging at the rear
- Rear seats – split folding 40:20:40
- Seat belts – crystal grey
- Steering wheel – multi-function AMG performance steering wheel in black nappa leather/DINAMICA microfibre

#### Trim and Upholstery

High-gloss black with brushed aluminium



Nappa leather – black



Nappa leather – platinum white



Nappa leather – red pepper



<sup>1</sup>COMAND Online functionality and Wi-Fi connectivity is dependent on a compatible cellular data connection. Please check with your local Mercedes-Benz Retailer on network compatibility

# Mercedes-AMG C 63 S Edition 1



Optional designo selenite grey magno (code 297) shown



The new Mercedes-AMG C 63 S Edition 1 wears its sporty pedigree on its sleeves. Inspired by the Mercedes-AMG C 63 DTM car, the polar white exterior is combined with graphite grey AMG decals on the hood, roof and boot lid. It also has sports stripes above the AMG side sill panels. Equally eye-catching, the 19"/20" alloy wheels feature a forged cross-spoke design in matt black with grey rim flange. To match these athletic credentials, there is the AMG Aerodynamics package with larger front splitter and rear apron diffuser revealing three vertical fins. Elements of the AMG Night package

with high-gloss black exterior details are also standard. The interior reflects this dynamic theme: black nappa leather upholstery with a diamond design and yellow contrast stitching adorns the AMG Performance seats, armrests and centre console. Yellow highlights can also be found in the instrument cluster and the analogue AMG IWC-design clock. Even the black floor mats with 'AMG' lettering carry yellow contrast topstitching. This premium design is met by premium technology including Burmester® surround sound system, KEYLESS-GO and LED Intelligent Light System.

#### Exterior

19"/20" AMG alloy wheels – forged cross-spoke design, painted matt black with grey rim flange

AMG Aerodynamic Package

AMG Night package

AMG decals in graphite grey for hood, roof and boot lid plus AMG side sports stripes above AMG side sill panels

AMG-specific spoiler lip

Larger front splitter

LED Intelligent Light System

Rear apron featuring a diffuser look with three vertical fins

#### Interior

AMG matt carbon fibre trim

Burmester® surround sound system

Dashboard and beltlines in nappa leather-look

KEYLESS-GO

Upholstery in black nappa leather – diamond design with yellow contrasting topstitching

#### Trim and Upholstery

AMG matt carbon fibre

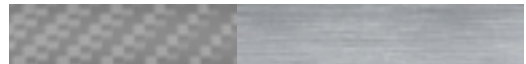

Nappa leather – black with yellow contrast topstitching



## Premium equipment line for Mercedes-AMG models



Panoramic glass sunroof



LED Intelligent Light System



KEYLESS-GO Comfort package

If you want to enhance the unique Mercedes-AMG C 63/S experience, opt for the Premium equipment line. It contains advanced features such as Burmester® surround sound system, KEYLESS-GO Comfort package plus a panoramic electric sunroof. LED Intelligent Light System ensures safety and convenience, while the Exclusive package with nappa leather-look dashboard and door beltlines takes sophistication to the next level.

**Premium equipment line** (code DP0) – designed and priced as a package, including items as listed below.

**Mercedes-AMG C 63/S** (standard on Edition 1) **Total incl. VAT £2,595.00**

**Premium equipment line comprises:**

---

Exclusive package

Nappa leather-look dashboard and door beltlines in nappa leather-look with contrast stitching

---

KEYLESS-GO Comfort package

Hands-free access, automatic powered boot closing, keyless entry and keyless start. Includes chrome trim on top half of door handles

---

Burmester® surround sound system

13 speakers and a 9-channel amplifier with total output of 590W (7 × 50W and 2 × 120W)

---

LED Intelligent Light System

LED High Performance headlamps, including Active Light System, cornering light function and Adaptive Highbeam Assist

---

Panoramic electric sunroof

Fixed panoramic glass rear section and electrically operated sliding glass front section

---

## Exclusive driver training for Mercedes-AMG owners

All Mercedes-AMG customers are invited to a complimentary AMG Driving Academy Training experience at Mercedes-Benz World.



With friendly one-to-one tuition from a professional Mercedes-AMG driver, your training will be personalised to you. You'll push Mercedes-AMG driving performance and your driving skills to the limits on our track and purpose-built low friction dynamic handling facilities.

Through high-speed and adrenaline-fuelled exercises you'll experience oversteer, understeer, slaloms and many more performance driving skills. Designed as part of your ownership experience, this will lay the foundations to master a high-performance vehicle, develop driving skills with maximum enjoyment and prepare you to take full command of your own Mercedes-AMG.

### TERMS AND CONDITIONS

The following only are eligible: the first purchaser/registered keeper of a newly-registered Mercedes-AMG; the second owner/registered keeper of a Mercedes-AMG purchased from a Mercedes-Benz Retailer, where the vehicle is less than 90 days from registration. The AMG Driving Academy Training experience is the AMG BASIC-Training as detailed in the further information above and must be booked and taken within six months of delivery of your Mercedes-AMG; it cannot be exchanged and cannot be transferred for any other driving experience. The Training experience is available Monday to Friday only and is subject to availability. Mercedes-Benz UK Limited reserves the right to amend or withdraw this Training experience. Attendees must hold a full UK driving licence. Attendees will be required to sign the Mercedes-Benz World Driving Risk Acknowledgement prior to undertaking the Training experience. The Training experience is also subject to the Mercedes-Benz World Terms and Conditions, as applicable.



> View offers



> Book a test drive



> Find a Retailer



> View the Range Guide





## Pricing summary for Premium and Premium Plus equipment lines

Model	Transmission	Recommended OTR price (£) <sup>1</sup>							
		Sport	Sport Premium	Sport Premium Plus	AMG Line	AMG Line Premium	AMG Line Premium Plus	Mercedes-AMG	Mercedes-AMG Premium
<b>C 220 d</b>	9G-TRONIC PLUS 9-speed auto.	34,965.00	36,660.00	37,960.00	36,460.00	38,155.00	39,455.00	-	-
<b>C 250 d</b>	9G-TRONIC PLUS 9-speed auto.	36,120.00	37,815.00	39,115.00	37,615.00	39,310.00	40,610.00	-	-
<b>C 200</b>	7G-TRONIC PLUS 7-speed auto.	32,455.00	34,150.00	35,450.00	34,080.00	35,775.00	37,075.00	-	-
<b>C 300</b>	7G-TRONIC PLUS 7-speed auto.	35,460.00	37,155.00	38,455.00	36,995.00	38,690.00	39,990.00	-	-
<b>Mercedes-AMG C 63</b>	AMG SPEEDSHIFT MCT 7-speed auto.	-	-	-	-	-	-	61,170.00	63,765.00
<b>Mercedes-AMG C 63 S</b>	AMG SPEEDSHIFT MCT 7-speed auto.	-	-	-	-	-	-	68,080.00	70,675.00

<sup>1</sup>Recommended on-the-road price: these prices reflect the Road Fund Licence applicable to the standard model plus £670.00 additional costs necessary to put your car on the road.

Included are a standard UK delivery charge (£540.00 incl. VAT), new vehicle registration fee (£55.00), number plates (£25.00 incl. VAT) and fuel (£50.00 incl. VAT). VAT is calculated at the standard rate of 20%

# Standard equipment

Item	Sport	AMG Line	Mercedes-AMG C 63	Mercedes-AMG C 63 S	Mercedes-AMG C 63 S Edition 1
<b>Steering, Suspension and Transmission</b>					
AMG electronic rear axle differential lock	-	-	-	●	●
AMG mechanical rear axle differential lock	-	-	●	-	-
AMG RIDE CONTROL sports suspension	-	-	●	●	●
AMG SPEEDSHIFT MCT 7-speed automatic sports transmission including RACE START function	-	-	●	●	●
AGILITY CONTROL comfort suspension – lowered by 15 mm	●	-	-	-	-
AGILITY CONTROL sports suspension – lowered by 15 mm	-	●	-	-	-
Driving modes – AMG DYNAMIC SELECT with a choice of AMG-specific driving modes (Comfort, Sport, Sport+, Individual and Race modes for the Mercedes-AMG C 63 S)	-	-	●	●	●
Driving modes – DYNAMIC SELECT with a choice of driving modes (Comfort, ECO, Sport, Sport+, Individual)	●	●	-	-	-
ECO start/stop function	●	●	●	●	●
Steering – Direct-Steer speed sensitive steering	●	-	-	-	-
Steering – Sports Direct-Steer system with speed sensitive steering	-	●	-	-	-
Steering column – electronically adjustable for height and reach	-	-	●	●	●
Steering column – manually adjustable for height and reach	●	●	-	-	-

Item	Sport	AMG Line	Mercedes-AMG C 63	Mercedes-AMG C 63 S	Mercedes-AMG C 63 S Edition 1
<b>Exterior</b>					
AMG Aerodynamic Package	-	-	-	-	●
AMG Night package	-	-	○	○	●
Mirror package – electrically folding mirrors and automatically dimming exterior driver’s mirror and rear-view mirror	●	●	●	●	●
AMG bodystyling – front apron, bonnet, side skirts, fenders and rear diffuser-style apron design	-	-	●	●	●
AMG bodystyling – front apron, rear apron and side skirts	-	●	-	-	-
AMG bonnet with powerdomes	-	-	●	●	●
AMG boot lid spoiler in body colour	-	-	●	●	●
AMG Performance exhaust system	-	-	●	●	●
Brake calipers – red with ‘AMG’ lettering	-	-	-	●	●
Brake calipers – silver with ‘AMG’ lettering	-	-	●	-	-
Brake calipers – with ‘Mercedes-Benz’ lettering and perforated front brake discs	-	●	-	-	-
Diamond grille with integrated star – black pins	●	-	-	-	-
Diamond grille with integrated star – chrome pins	-	●	-	-	-
Exterior mirrors – heated and electronically adjustable	●	●	●	●	●
Fuel tank – 66-litre	●	●	●	●	●

Item	Sport	AMG Line	Mercedes-AMG C 63	Mercedes-AMG C 63 S	Mercedes-AMG C 63 S Edition 1
<b>Exterior (continued)</b>					
Headlamps – LED High Performance headlamps with integral LED daytime running lamps	●	●	●	●	●
Heated windscreen wash	●	●	●	●	●
Rain-sensing windscreen wipers	●	●	●	●	●
Sport exhaust system (C 300 only)	●	●	–	–	–
Tail lamps – full LED	●	●	●	●	●
Tinted glass all round – green	●	●	●	●	●
Top surround of side windows in polished aluminium	●	●	●	●	●
‘V8 BITURBO’ lettering on front wings	–	–	●	●	●
Visible twin-pipe exhaust trim integrated into rear bumper	–	●	–	–	–

Item	Sport	AMG Line	Mercedes-AMG C 63	Mercedes-AMG C 63 S	Mercedes-AMG C 63 S Edition 1
<b>Interior</b>					
Interior Lighting package Lighting of footwells, door handle recesses, as well as rear reading lights (LED) and courtesy lights in all doors	●	●	●	●	●
Memory package Driver’s seat, front passenger seat, steering column and exterior mirrors – electrically adjustable with memory	△	△	●	●	●
Seat Comfort package Electro-pneumatic four-way lumbar support for driver and front passenger seat Manual seat cushion depth adjustment (6 cm)	●	●	–	–	–
Stowage package Including luggage net in boot and folding box under luggage compartment floor	●	●	●	●	●
Ambient lighting LED lighting located in door trim, side of centre console, front door sills, cup holders, footwells, door handle recesses and overhead panel. Five dimming levels and three colours: solar (amber), polar (ice blue) and neutral (white)	△	△	●	●	●
AMG instrument cluster	–	–	●	●	●
ARTICO leather <sup>1</sup> upper dashboard with contrast stitching	–	○	●	●	●



## Standard equipment

32

Item	Sport	AMG Line	Mercedes-AMG C 63	Mercedes-AMG C 63 S	Mercedes-AMG C 63 S Edition 1
<b>Interior (continued)</b>					
Electric windows (2) – one-touch opening and closing, including obstruction sensors	●	●	●	●	●
Electronic key – chrome surround	●	●	●	●	●
Floor mats – black with ‘AMG’ lettering	–	●	●	●	●
Front door sill panels with ‘AMG’ lettering	–	–	●	●	●
Front door sill panels with ‘Mercedes-Benz’ lettering	●	●	–	–	–
Gear lever and gear lever gaiter in nappa leather (manual transmission only)	●	●	–	–	–
Gearshift paddle on steering wheel (automatic transmission only)	●	●	●	●	●
Instrument cluster with two tube-design round dials and 5.5-inch TFT multi-function display	●	●	–	–	–
Outside temperature display	●	●	●	●	●
Seats – AMG Performance seats	–	–	○	●	●
Seats – AMG sports seats	–	–	●	–	–
Seats – front, heated	●	●	●	●	●
Seats – front, with electrical height and back, and four-way lumbar adjustment	●	●	●	●	●
Seats – rear, split folding 40:20:40	●	●	●	●	●
Seats – sports seats with integrated head restraints	●	●	–	–	–
Seat belts – black	●	●	●	–	●

Item	Sport	AMG Line	Mercedes-AMG C 63	Mercedes-AMG C 63 S	Mercedes-AMG C 63 S Edition 1
Seat belts – crystal grey	–	–	–	●	–
Sports pedals in brushed stainless steel with rubber studs	–	●	●	●	●
Steering wheel – 3-spoke multi-function AMG performance steering wheel in black nappa leather/DINAMICA microfibre	–	–	–	●	●
Steering wheel – 3-spoke multi-function AMG steering wheel in black nappa leather	–	–	●	–	–
Steering wheel – 3-spoke multi-function AMG steering wheel in leather with flattened bottom section, chrome inserts and perforated leather in grip area	–	●	–	–	–
Steering wheel – 3-spoke, trimmed in leather	●	–	–	–	–
Steering wheel – multi-function with audio and onboard settings control	●	●	●	●	●
Stowage – front centre armrest with stowage compartment	●	●	●	●	●
Stowage – double cupholder in centre console	●	●	●	●	●
Stowage – illuminated glove compartment	●	●	●	●	●
Sun visors with illuminated vanity mirrors	●	●	●	●	●
THERMATIC – automatic climate control, two-zone	●	●	●	●	●



Standard equipment

Item	Sport	AMG Line	Mercedes-AMG C 63	Mercedes-AMG C 63 S	Mercedes-AMG C 63 S Edition 1
<b>Paint, Trim and Upholstery</b>					
Paint – non-metallic	●	●	●	●	●
Trim – black ash wood with aluminium door trims	-	●	○	○	○
Trim – high-gloss black with aluminium door trims	●	○	●	●	-
Trim – AMG matt carbon fibre	-	-	-	-	●
Upholstery – ARTICO leather <sup>1</sup>	●	●	-	-	-
Upholstery – nappa leather	-	-	●	●	-
Upholstery – black nappa leather with yellow contrast stitching	-	-	-	-	●
<b>Safety and Assistance Systems</b>					
AMG high-performance braking system	-	-	●	●	●
Active bonnet – pedestrian safety measure which detects an impact and raises bonnet	●	●	●	●	●
Active Parking Assist including PARKTRONIC The system automatically steers vehicle into parking spaces. Bay and parallel parking capable	●	●	●	●	●
Adaptive Brake Assist with HOLD function and brake-drying function	●	●	●	●	●
Adaptive brake lamps	●	●	●	●	●
Anti-lock braking system (ABS)	●	●	●	●	●
Anti-Theft Protection package – consisting of a break-in and anti-theft alarm system (ATA), interior monitoring and tow-away protection	●	●	●	●	●

Item	Sport	AMG Line	Mercedes-AMG C 63	Mercedes-AMG C 63 S	Mercedes-AMG C 63 S Edition 1
ATTENTION ASSIST – can help alert to long journey fatigue	●	●	●	●	●
Automatic child seat recognition sensor	●	●	●	●	●
Central locking with interior switch, automatic locking and crash sensor with emergency opening function	●	●	●	●	●
COLLISION PREVENTION ASSIST PLUS	●	●	●	●	●
Diesel particulate filter (diesel models only)	●	●	-	-	-
Dual-stage airbags – driver and front passenger; sidebags in front seats; driver kneebag; pelvis bag and windowbags for driver, front passenger and rear passengers	●	●	●	●	●
Electric parking brake	●	●	●	●	●
Electronic Stability Programme (ESP®)	●	●	●	●	●
First-aid kit and warning triangle	●	●	●	●	●
ISOFIX child seat attachment points with top tether in rear	●	●	●	●	●
Remote boot release	●	●	●	●	●
Reversing camera	●	●	●	●	●
Service indicator ASSYST	●	●	●	●	●
SPEEDTRONIC cruise control with variable speed limiter	●	●	●	●	●
Status display for rear seat belts in instrument cluster	●	●	●	●	●
TIREFIT with tyre inflation compressor	●	●	●	●	●
Tyre pressure monitoring system	●	●	●	●	●

Item	Sport	AMG Line	Mercedes-AMG C 63	Mercedes-AMG C 63 S	Mercedes-AMG C 63 S Edition 1
<b>Communications and In-Car Entertainment</b>					
Audio 20 CD including touchpad with integrated Media Interface	●	●	-	-	-
Bluetooth® interface for hands-free telephony	●	●	●	●	●
COMAND Online system <sup>1</sup>	△	△	●	●	●
Hard disk drive (HDD) navigation with 3D map display, Live Traffic Information and European map data updates free of charge for the first three years. Single CD/DVD, Speed Limit Assist and LINGUATRONIC voice control. Access to internet sites when vehicle is stationary, plus unrestricted use of Mercedes-Benz apps (internet-enabled mobile phone required). Integrated WLAN hotspot for onboard access of WLAN-enabled devices. Also includes 10GB music register and MP3 compatibility					
DAB digital radio tuner	●	●	●	●	●
Garmin® MAP PILOT navigation system	●	●	-	-	-
Operation via controller, touchpad or voice control. SD card navigation with instructions shown on 7-inch high-resolution colour display and in the instrument cluster. Includes 3D views with visualisation of roads and buildings as well as junction and lane assistants, making it easy for drivers to orientate themselves. Spoken instructions are emitted through vehicle's built-in speakers. Software and map can be updated online					
High-resolution 7-inch multimedia colour display	●	●	-	-	-
High-resolution 8.4-inch multimedia colour display	-	-	●	●	

Item	Sport	AMG Line	Mercedes-AMG C 63	Mercedes-AMG C 63 S	Mercedes-AMG C 63 S Edition 1
Mercedes me connect (Remote Online)	△	△	●	●	●
Onboard use of the remote and location services, e.g. geographic vehicle monitoring, vehicle location, remote door locking and unlocking, remote interrogation of vehicle status.					
Remote Online subscription services are limited to three years from initial registration, and can be extended at additional cost					
Mercedes me connect (standard services)	●	●	●	●	●
Including emergency call system (eCall), accident recovery, breakdown and maintenance management					
Radio aerial integrated into rear window	●	●	●	●	●
Speakers with Frontbass	●	●	●	●	●
Two USB ports and one SD card slot in centre console	●	●	●	●	●

● Standard ○ Optional - Not available △ Available only as part of optional Premium or Premium Plus equipment line (code DP0 and DP1)

<sup>1</sup>COMAND Online functionality and Wi-Fi connectivity is dependent on a compatible cellular data connection. Please check with your local Mercedes-Benz Retailer on network compatibility



> View offers



> Book a test drive



> Find a Retailer





> View the Range Guide

Wheels



35

# A revolution in style

Item	Notes		R48	Sport	AMG Line	Mercedes-AMG C 63	Mercedes-AMG C 63 S	Mercedes-AMG C 63 S Edition 1	Basic RRP excl. VAT (£)	Total RRP incl. VAT (£)
Wheels										
17" alloy wheels (4) – 5-twin-spoke design 225/50 tyres				●	-	-	-	-	-	-
18" AMG alloy wheels (4) – 5-spoke design, painted titanium grey front: 225/45 tyres rear: 245/40 tyres			782	-	●	-	-	-	-	-
19" AMG alloy wheels (4) – multi-spoke design, painted titanium grey front: 225/40 tyres rear: 255/35 tyres	Includes run-flat tyres		788	-	○	-	-	-	495.83	595.00

● Standard ○ Optional - Not available



Item	Notes		Sport	AMG Line	Mercedes-AMG C 63	Mercedes-AMG C 63 S	Mercedes-AMG C 63 S Edition 1	Basic RRP excl. VAT (£)	Total RRP incl. VAT (£)
<b>Wheels (continued)</b>									
18" AMG alloy wheels (4) – 5-twin-spoke design, painted titanium grey front: 255/40 tyres rear: 285/35 tyres			609	-	-	●	-	-	-
19" AMG alloy wheels (4) – 5-twin-spoke design, painted titanium grey front: 255/35 tyres rear: 285/30 tyres	Red brake calipers only with Mercedes-AMG C 63 S		601	-	-	○	-	495.83	595.00
19"/20" AMG alloy wheels (4) – forged cross-spoke design, painted titanium grey front: 255/35 tyres rear: 285/30 tyres	Red brake calipers only with Mercedes-AMG C 63 S		766	-	-	○	-	1,875.00	2,250.00
				-	-	○	-	1,133.33	1,360.00





Item	Notes		Sport	AMG Line	Mercedes-AMG C 63	Mercedes-AMG C 63 S	Mercedes-AMG C 63 S Edition 1	Basic RRP excl. VAT (£)	Total RRP incl. VAT (£)
<b>Wheels (continued)</b>									
19"/20" AMG alloy wheels (4) – forged cross-spoke design, painted matt black front: 255/35 tyres rear: 285/30 tyres	Red brake calipers only with Mercedes-AMG C 63 S. With Edition 1 grey rim flange		767	-	-	○	-	2,083.33	2,500.00
			-	-	-	○	-	1,445.83	1,735.00
			-	-	-	●	-	-	-
19"/20" AMG Performance alloy wheels (4) – forged 5-twin-spoke design, painted matt black with yellow rim flange front: 255/35 tyres rear: 285/30 tyres			RXQ	-	-	-	-	Included with Edition 1 'Motorsport' package	
-	-	-	-	○					

## Driving Assistance package

The Driving Assistance package contains a range of highly intelligent features to help you stay safe on the road – by making the drive more effortless, by warning of danger, and by taking steps to protect you in an emergency. It includes Active Blind Spot Assist, Active Lane Keeping Assist, BAS PLUS with Cross-Traffic Assist, DISTRONIC PLUS with Steering Assist and Stop&Go Pilot, and the PRE-SAFE® anticipatory safety system.

**Driving Assistance package** (code DP2) – designed and priced as a package, including items as listed.

**All models: only available with automatic transmission**

**Total incl. VAT £1,695.00**

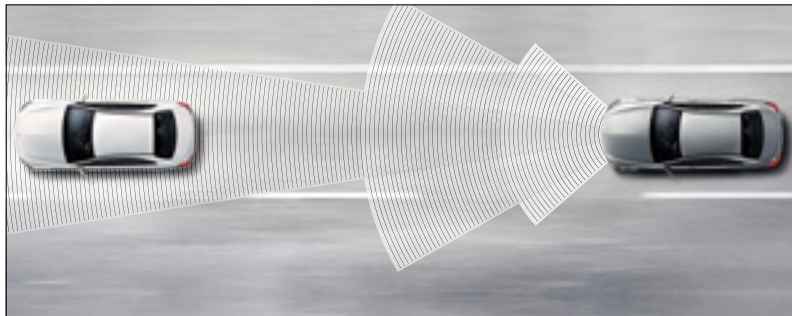

DISTRONIC PLUS

### Driving Assistance package comprises:

#### Active Blind Spot Assist

Displays a warning light in the exterior mirrors if another vehicle is detected in the blind spot. If a lane change is attempted with another vehicle in the blind spot, the system warns the driver and helps prevent an imminent collision by one-sided braking intervention

#### Active Lane Keeping Assist

Detects signs of inadvertent drifting out of lane and warns the driver by vibrating the steering wheel and, if necessary, triggers one-sided braking intervention

#### BAS PLUS with Cross-Traffic Assist

If a critical situation is recognised and the driver applies the brakes, BAS PLUS can increase the brake pressure according to the situation, ideally preventing a collision with other vehicles or pedestrians

#### DISTRONIC PLUS with Steering Assist and Stop&Go Pilot

DISTRONIC PLUS is a radar assisted cruise control that helps the driver to maintain a safe distance from the vehicle ahead, even when braking to a stand-still. Steering Assist tracks road markings and the path of the vehicle ahead to keep the vehicle on track

#### PRE-SAFE® Brake with pedestrian detection

When the danger of a collision with another vehicle or a pedestrian is recognised, PRE-SAFE® Brake gives the driver a visual and acoustic warning. If there is no reaction, the system can reduce the vehicle speed autonomously – right up to full emergency braking

#### PRE-SAFE® PLUS

Initiates occupant prevention measures if a rear-end collision is imminent, including activating the hazard lights, reversible belt tensioning, adjustment of passenger seat positions and closure of windows

## Optional equipment



Privacy glass



Head-up display



LED Intelligent Light System (standard on Edition 1 and with Premium equipment line for Mercedes-AMG)



Panoramic glass sunroof (standard with Premium and Premium Plus equipment lines)

Item	Notes		Sport	AMG Line	Mercedes-AMG C 63	Mercedes-AMG C 63 S	Mercedes-AMG C 63 S Edition 1	Basic RRP excl. VAT (£)	Total RRP incl. VAT (£)
<b>AMG Performance Studio</b>									
AMG Driver's package Includes an increase to your vehicle's electronically limited top speed (180 mph) and participation in one of the AMG BASIC-Training 'Power and Passion' events. The event is run by the AMG Driving Academy and held at a racetrack located in mainland Europe	For further information on this or any other AMG Driving Academy training, please speak to your Retailer, or visit <a href="http://www.mercedes-amg.com/driving-academy">www.mercedes-amg.com/driving-academy</a>	250	-	-	○	-	-	2,295.83	2,755.00
			-	-	-	○	○	637.50	765.00
AMG Exterior Carbon Fibre package 1 Carbon fibre insert in rear apron Front apron in carbon fibre Side panels with carbon fibre inserts	Carbon fibre inserts in side panels are omitted on Edition 1	773	-	-	○	○	○	2,808.33	3,370.00
AMG Exterior Carbon Fibre package 2 AMG carbon fibre exterior mirror housing AMG carbon fibre spoiler lip	AMG carbon fibre spoiler lip is omitted on Edition 1	B28	-	-	○	○	○	1,050.00	1,260.00
AMG Interior Carbon Fibre Trim package Analogue clock Centre console in carbon fibre optic Door panels in aluminium trim		H73	-	-	○	○	-	583.33	700.00
AMG Interior Glass Fibre Trim package Analogue clock Centre console in matt glass fibre optic Door panels in aluminium trim		H84	-	-	○	○	-	583.33	700.00

Item	Notes		Sport	AMG Line	Mercedes-AMG C 63	Mercedes-AMG C 63 S	Mercedes-AMG C 63 S Edition 1	Basic RRP excl. VAT (£)	Total RRP incl. VAT (£)
<b>AMG Performance Studio (continued)</b>									
AMG Night package AMG exhaust system with two black chrome-plated twin tailpipe trim elements AMG side sill panel inserts in high-gloss black Beltline trim strip and window surround in high-gloss black Exterior mirror housings in high-gloss black Front apron in high-gloss black Privacy glass Rear apron trim strip in high-gloss black		P60	-	-	○	○	●	487.50	585.00
Edition 1 'Motorsport' package 19"/20" AMG Performance 5-twin-spoke forged wheels painted in matt black and with yellow-painted rim flange AMG high-performance ceramic composite braking system designo selenite grey magno paint Yellow AMG decals for hood, roof and boot lid plus AMG side sports stripes on side panels		P97+RXQ	-	-	-	-	○	2,500.00	3,000.00
AMG high-performance ceramic composite braking system		B07	-	-	-	○	○	3,570.83	4,285.00
AMG Performance seats Cushion depth adjustment Pneumatically adjustable seat side bolsters Steep seat angle and optimum lateral support for dynamic driving		555	-	-	○	●	●	1,170.83	1,405.00
Sports tyres <sup>1</sup> Greater steering precision Tangible and measurable increase in grip for ambitious laps on racetracks	Only available in conjunction with Edition 1 'Motorsport' (code P97+RXQ)	R03	-	-	-	-	○	458.33	550.00





Item	Notes		Sport	AMG Line	Mercedes-AMG C 63	Mercedes-AMG C 63 S	Mercedes-AMG C 63 S Edition 1	Basic RRP excl. VAT (£)	Total RRP incl. VAT (£)
<b>Suspension</b>									
AIRMATIC Dynamic Handling package Enhances the ability to tailor the driving experience by combining suspension set-up with each of the driving modes accessed via the DYNAMIC SELECT switch Self-levelling suspension can be raised by 25 mm to increase ground clearance and automatically lowers by up to 15 mm at high speeds to help reduce aerodynamic drag and improve handling stability Variable damper control, which optimises damping at each wheel to suit the speed and road conditions		483	○	○	-	-	-	735.83	895.00
<b>Exterior</b>									
360° camera Four networked cameras in front grille, wing mirrors and boot capture a 360° bird's-eye view of vehicle's immediate surroundings		501	○	○	○	○	○	279.17	335.00
Headlamps - LED Intelligent Light System Automatically adapts light intensity appropriately to weather, lighting and speed. Integrated High beam Assist automatically adjusts the high and low beam to the traffic situation. The cornering function automatically pivots headlamps into upcoming bends to ensure maximal visibility. The 'coming home' function lets the front headlamps illuminate blue when opening and closing the vehicle via key	Included in Premium equipment line (code DP0) on Mercedes-AMG C 63/S	641	○	○	○	○	○	454.17	545.00
Panoramic glass sunroof Consisting of a fixed panoramic glass rear section and electrically operated sliding glass front section	Only available as part of Premium equipment line (code DP0) on Mercedes-AMG C 63/S	413	○	○	△	△	●	750.00	900.00

Item	Notes		Sport	AMG Line	Mercedes-AMG C 63	Mercedes-AMG C 63 S	Mercedes-AMG C 63 S Edition 1	Basic RRP excl. VAT (£)	Total RRP incl. VAT (£)
<b>Exterior (continued)</b>									
Privacy glass Includes side windows rear of B-pillar and rear windscreen	Included in AMG Night package (code P60)	840	○	○	○	○	●	220.83	265.00
Tow bar, manually folding – includes 13-pin socket When ordering please discuss with your Retailer any specific electrical towing requirements	Excludes 7-pin adapter. When ordered with Premium equipment line (code DP0) or Premium Plus equipment line (code DP1) hands-free access (code 871) is removed	550	○	○	–	–	–	625.00	750.00
<b>Paint, Trim and Upholstery</b>									
Paint – metallic		1	○	○	○	○	○	537.50	645.00
Paint – designo diamond white metallic		799	○	○	○	○	○	704.17	845.00
Paint – designo selenite grey magno		297 982	○	○	○	○	○	1,412.50	1,695.00
Paint – designo iridium silver magno		982	–	–	○	○	○	1,412.50	1,695.00
Paint – designo hyacinth red metallic	Please check availability with your Retailer	996	○	○	–	–	–	704.17	845.00
Trim – black ash wood with aluminium door trims	Analogue clock only with automatic transmission	736	–	●	○	○	○	162.50	195.00
Trim – dark brown ash wood	Analogue clock only with automatic transmission	H09	○	○	–	–	–	162.50	195.00
			–	○	–	–	–		no-cost option
Trim – high-gloss black with aluminium door trims		739	●	○	●	●	–		no-cost option
Upholstery – ARTICO leather <sup>1</sup> upper dashboard and beltlines with contrast stitching		U09	–	○	●	●	–	333.33	400.00
Upholstery – leather		1	○	○	–	–	–	662.50	795.00
Upholstery – platinum white nappa leather		851A	–	–	○	○	○		no-cost option
Upholstery – red pepper nappa leather		857A	–	–	○	○	○		no-cost option



Item	Notes		Sport	AMG Line	Mercedes-AMG C 63	Mercedes-AMG C 63 S	Mercedes-AMG C 63 S Edition 1	Basic RRP excl. VAT (£)	Total RRP incl. VAT (£)
<b>Comfort</b>									
AIR-BALANCE package Interior fragrance dispenser. Fragrance can be changed by exchanging the flasks in the glove compartment. Intensity and duration of fragrance diffusion can be adjusted. Oxygen ionisation and improved filtering system		P21	<input type="radio"/>	<input type="radio"/>	<input type="radio"/>	<input type="radio"/>	<input type="radio"/>	291.87	350.00
<b>Communications and In-Car Entertainment</b>									
Head-up display Projects key driver information such as vehicle speed, navigation tips, speed limits as virtual colour image (21 x 7 cm) into the driver's field of vision. Special light sensors adjust the brightness of the heads-up display to ensure good visibility without distraction. The display is easily height adjustable		463	<input type="radio"/>	<input type="radio"/>	<input type="radio"/>	<input type="radio"/>	<input type="radio"/>	687.50	825.00
Mercedes me connect (Remote Online) Onboard use of the remote and location services, e.g. geographic vehicle monitoring, vehicle location, remote door locking and unlocking, remote interrogation of vehicle status. Remote Online subscription services are limited to three years from initial registration, and can be extended at additional cost	Standard in conjunction with COMAND Online system – part of the Premium Plus equipment line (code DP1)	05U	<input type="radio"/>	<input checked="" type="radio"/>	<input checked="" type="radio"/>	<input checked="" type="radio"/>		125.00	150.00



> View offers



> Book a test drive



> Find a Retailer



> View the Range Guide

Optional equipment

45

Item	Notes	Sport	AMG Line	Mercedes-AMG C 63	Mercedes-AMG C 63 S	Mercedes-AMG C 63 S Edition 1	Basic RRP excl. VAT (£)	Total RRP incl. VAT (£)	
<b>Service Package</b>									
Service Care Service Care allows you to spread the cost of servicing your new car in the Mercedes-Benz Retailer network. Taking out a Service Care plan ensures your servicing needs are taken care of by fully trained Mercedes-Benz Technicians with the added benefit of a Mercedes-Benz service history	Price is based on a monthly rate. Example given is for two services taken over 24 months, three services over 36 months or four services over 48 months. Further payment options are available. New Service Care prices apply only to vehicles up to 12 months old prior to first service. Prices correct up to 30 April 2016	1	○	○	-	-	-	25.00	30.00
		-	-	○	○	○	33.33	40.00	

# Colours and materials

## Non-metallic paints

Standard

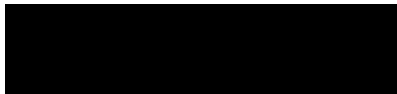

040 black<sup>1</sup>



149 polar white<sup>2</sup>

## Metallic paints

Optional

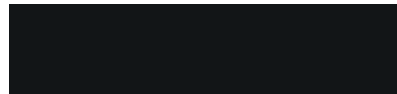

197 obsidian black



896 brilliant blue



775 iridium silver



988 diamond silver



890 cavansite blue



992 selenite grey

## Special paints

Additional-cost option



297 designo selenite grey magno<sup>3</sup>

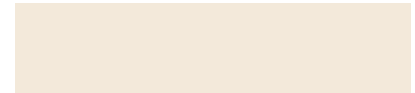

799 diamond white



982 designo iridium silver magno<sup>4</sup>



996 designo hyacinth red metallic<sup>5</sup>

<sup>1</sup>Standard (Sport and AMG Line) <sup>2</sup>Standard (Mercedes-AMG C 63/S/Edition 1); no-cost option (Sport and AMG Line) <sup>3</sup>Standard on Edition 1 as part of Edition 1 'Motorsport' (code P97+RXQ) <sup>4</sup>Mercedes-AMG C 63/S/Edition 1 only <sup>5</sup>Sport and AMG Line only  
Please note that, owing to limitations of on-screen representation, paint colours may differ from those shown



**Sport/AMG Line upholstery**

ARTICO man-made leather (standard)



111A black



118A crystal grey<sup>1</sup>



124A saddle brown<sup>1</sup>



105A silk beige<sup>1</sup>

Leather (additional-cost option)



201A black



218A crystal grey



224A saddle brown



225A porcelain



227A cranberry red

**Mercedes-AMG C 63/S/Edition 1 upholstery**

Nappa leather



801A/811A/861A black



851A platinum white<sup>2</sup>



857A red pepper<sup>2</sup>

**Trim**



736 black ash wood with brushed aluminium<sup>3</sup>

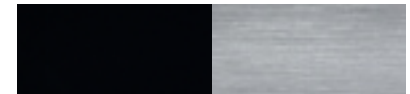

739 high-gloss black with brushed aluminium<sup>4</sup>



H09 dark brown ash wood<sup>2</sup>

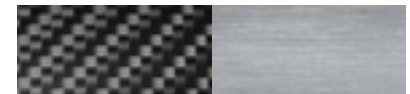

H73 carbon fibre with brushed aluminium<sup>2</sup>

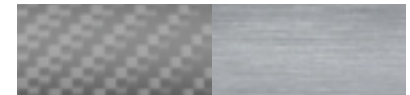

H77 AMG matt carbon fibre<sup>5</sup>



H84 glass fibre with brushed aluminium<sup>2</sup>

<sup>1</sup>No-cost option   <sup>2</sup>Additional-cost option   <sup>3</sup>Standard on AMG Line; additional-cost option on Mercedes-AMG C 63/S/Edition 1   <sup>4</sup>Standard on Sport and Mercedes-AMG C 63/S; no-cost option on AMG Line   <sup>5</sup>Standard on Mercedes-AMG C 63 S Edition 1

# Trim and upholstery combinations

	Sport/AMG Line				Mercedes-AMG C 63/S [Edition 1]		
	ARTICO man-made leather				Nappa leather		
	black (101A)	crystal grey (118A)	saddle brown (124A)	silk beige (105A)	black (801A/811A) [861A]	platinum white (851A)	red pepper (857A)
<b>Dashboard</b>							
Steering wheel	black	black	black	black	black	black	black
Upper dashboard trim	black	black	black	black	black [yellow contrast stitching]	black	black
Lower dashboard trim	black	crystal grey	black	silk beige	black	black	black
<b>Seats</b>							
Seat cushion centre section	black	crystal grey	saddle brown	silk beige	black [yellow contrast stitching]	platinum white	red pepper
Side bolster trim	black	crystal grey	saddle brown	silk beige	black	black	black
Head restraint	black	crystal grey	saddle brown	silk beige	black	black	black
Seat belt	black	crystal grey	black	silk beige	black (crystal grey <sup>1</sup> )	black (crystal grey <sup>1</sup> )	black
<b>Doors</b>							
Door trim at beltline	black	black	black	black	black (crystal grey <sup>1</sup> )	black	black
Door centre panel	black	crystal grey	saddle brown	silk beige	black [yellow contrast stitching]	black	red pepper
<b>Roof liner</b>	black	crystal grey (black <sup>2</sup> )	black	black	black	black	black
<b>Parcel shelf</b>	black	crystal grey (black <sup>2</sup> )	black	black	black	black	black
<b>Floor covering</b>							
Front and rear	black	black	black	silk beige	black	black	black

<sup>1</sup>Dependant on roof liner colour <sup>2</sup>Standard on AMG Line



# Combination options

		ARTICO leather <sup>1</sup> Sport/AMG Line				Leather Sport/AMG Line					Nappa leather Mercedes-AMG C 63/S/Edition 1		
		black	crystal grey	saddle brown	silk beige	black	crystal grey	saddle brown	porcelain	cranberry red	black	platinum white	red pepper
<b>Non-metallic paints (standard)</b>													
	040 black	●	●	●	●	●	●	●	●	●	-	-	-
	149 polar white	●	●	●	●	●	●	●	●	●	●	●	●
<b>Metallic paints (optional)</b>													
	197 obsidian black	●	●	●	●	●	●	●	●	●	●	●	●
	775 iridium silver	●	●	●	●	●	●	●	●	●	●	●	●
	890 cavansite blue	●	●	●	●	●	●	●	○	○	-	-	-
	896 brilliant blue	●	●	●	●	●	●	●	●	△	●	●	△
	988 diamond silver	●	●	●	●	●	●	●	○	●	-	-	-
	992 selenite grey	●	●	●	●	●	●	●	●	●	-	-	-
<b>Special paints (additional-cost option)</b>													
	297 designo selenite grey magno	●	●	●	●	●	●	●	●	●	●	●	●
	799 diamond white	●	●	●	●	●	●	●	●	●	●	●	●
	982 designo iridium silver magno	-	-	-	-	-	-	-	-	-	●	●	●
	996 designo hyacinth red metallic	●	●	△	○	●	●	△	○	●	-	-	-

# Technical data

Model	Diesel engines		Petrol engines			
	C 220 d	C 250 d	C 200	C 300	Mercedes-AMG C 63 [S] [Edition 1]	
<b>Engine</b>						
Total displacement	cc	2,143	2,143	1,991	1,991	3,982
Arrangement/cylinders/valves		in-line/4/16	in-line/4/16	in-line/4/16	in-line/4/16	V/8/32
Fuel delivery		Common-rail diesel with twin turbochargers	Common-rail diesel with twin turbochargers	Electronically controlled direct injection	Electronically controlled direct injection	Electronically controlled direct injection with biturbo
Power <sup>1</sup>	hp (kW) at rpm	170 (125)/3,000–4,200	204 (150)/3,800	184 (135)/5,500	245 (180)/5,500	476 (350)/5,500–6,250 [510 (375)/5,500–6,250] {510 (375)/5,500–6,250}
Torque <sup>1</sup>	Nm at rpm	400/1,400–2,800	500/1,600–1,800	300/1,200–4,000	370/1,300–4,000	650/1,750–4,500 [700/1,750–4,500] {700/1,750–4,500}
Compression ratio		16.2:1	16.2:1	9.8:1	9.8:1	10.5:1
<b>Transmission</b>						
6-speed manual <sup>2</sup>		●	–	●	–	–
7G-TRONIC PLUS 7-speed automatic <sup>2</sup>		–	–	○	●	–
9G-TRONIC PLUS 9-speed automatic <sup>2</sup>		○	●	–	–	–
AMG SPEEDSHIFT MCT 7-speed automatic sports transmission <sup>2</sup>		–	–	–	–	●





Model	Diesel engines			Petrol engines				
	C 220 d	C 250 d		C 200	C 300		Mercedes-AMG C 63 [S] [Edition 1]	
<b>Fuel consumption<sup>5,6</sup></b>	mpg	man.	auto.	auto.	man.	auto.	auto.	auto.
Urban		56.5	60.1	58.9	41.5	40.9	34.5	24.8
Extra-urban <sup>7</sup>		78.5	76.4	74.3	64.2	62.8	54.3	40.9
Combined		68.9	68.9	67.3	53.3	52.3	44.8	32.8
<b>CO<sub>2</sub> emissions<sup>6</sup></b>	g / km	man.	auto.	auto.	man.	auto.	auto.	auto.
Emissions standard		EU6		EU6	EU6		EU6	EU6
17" 225/50 tyres		106	106	109	123	125	146	-
18" 245/40 tyres		113	109	112	132	133	154	200
19" 255/35 tyres		116	113	116	136	137	157	-
19" 265/35 tyres		-	-	-	-	-	-	200
19"/20" 285/30 tyres		-	-	-	-	-	-	200 [200] [209*]
<b>Insurance group ratings</b>		man.	auto.	auto.	man.	auto.	auto.	auto.
Base model: Sport/AMG Line		31/32	31/32	37/37	32/32	32/32	36/37	tba [tba] [tba]
Incl. Premium equipment line		-/-	32/32	38/38	-/-	33/33	37/37	
Incl. Premium Plus equipment line		-/-	32/33	38/38	-/-	33/34	37/37	

<sup>1</sup>Figures according to Directive 80/1269/EEC in the currently applicable version <sup>2</sup>With ECO start/stop <sup>3</sup>Electronically limited

<sup>4</sup>Figures according to Directive 92/21/EC (kerb weight with fuel tank 90% full, driver 68 kg, and luggage 7 kg) for standard-specification vehicles <sup>5</sup>All figures are based on a standard specification with the smallest tyre size

<sup>6</sup>The choice of wheels and transmission may affect CO<sub>2</sub> emissions and corresponding Road Fund Licence <sup>7</sup>EUDC: extra-urban driving cycle. Testing procedures adhere to EU Directive 93/116

\*Only applicable if Edition 1 'Motorsport' package (code P97 + RXQ) and sports tyres (code R03) have been selected

The figures on pages 50–53 are correct at time of publication. Please refer to the government website for latest data – <http://carfueldata.direct.gov.uk/>



> View offers



> Book a test drive



> Find a Retailer



> View the Range Guide

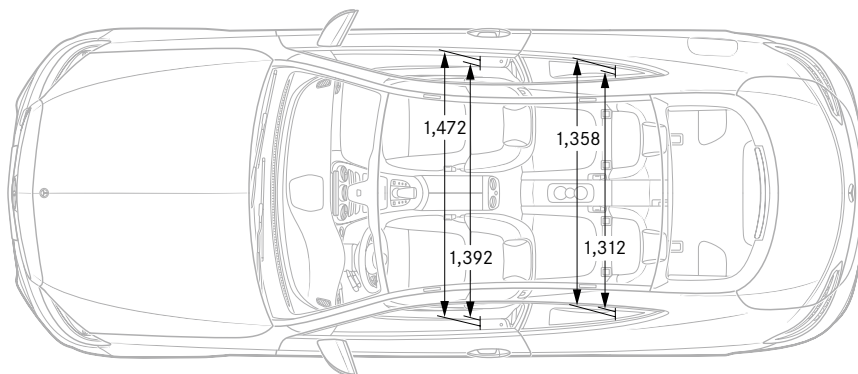
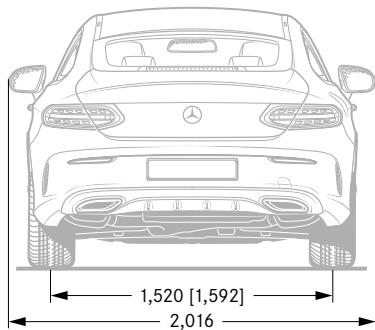
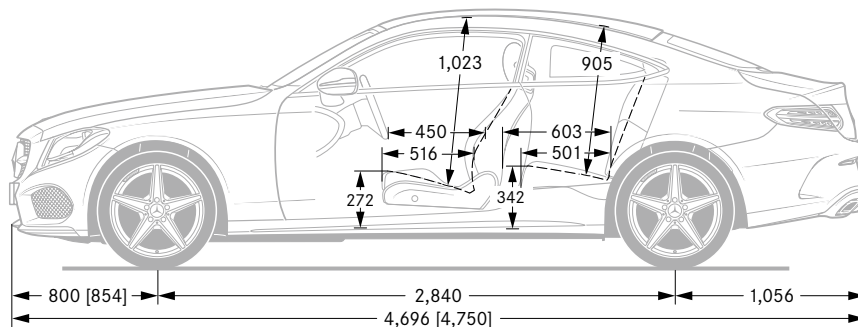
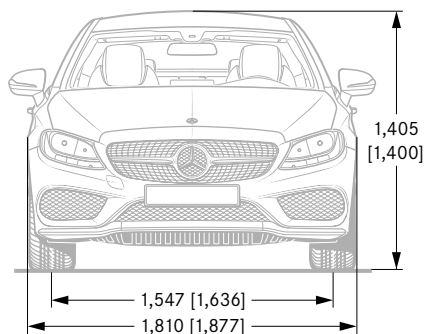

Figures in square brackets relate to Mercedes-AMG models.

All measurements in millimetres. The dimensions are mean values and apply to standard-specification, unladen vehicles

# Road Fund Licence



All road vehicle registrations are subject to Vehicle Excise Duty (Road Fund Licence), which varies in accordance with the vehicle's CO<sub>2</sub> emissions. A first year rate of Vehicle Excise Duty applies to new cars on their first year of registration. For the second and subsequent years a standard rate for each taxation band will apply.<sup>1</sup> The table below shows the bands (A–M) created by the DVLA and the corresponding Road Fund Licence. CO<sub>2</sub> emissions are listed in the technical data on page 52, and the relevant Excise Duty is reflected in the on-the-road prices on page 8.

Band	CO <sub>2</sub> emissions	First year rate (£)	Standard rate (£)
A	up to 100 g/km	0.00	0.00
B	101 to 110 g/km	0.00	20.00
C	111 to 120 g/km	0.00	30.00
D	121 to 130 g/km	0.00	110.00
E	131 to 140 g/km	130.00	130.00
F	141 to 150 g/km	145.00	145.00
G	151 to 165 g/km	185.00	185.00
H	166 to 175 g/km	300.00	210.00
I	176 to 185 g/km	355.00	230.00
J	186 to 200 g/km	500.00	270.00
K	201 to 225 g/km	650.00	295.00
L	226 to 255 g/km	885.00	500.00
M	over 255 g/km	1,120.00	515.00

<sup>1</sup>For further information on vehicle taxation please refer to <http://carfueldata.direct.gov.uk/>

# Services and insurance

## Mercedes-Benz Service Care

We believe that servicing costs should be as flexible and affordable as possible for your C-Class, which is why we offer Service Care, an easy way to budget for all your servicing costs. It spreads your bills into manageable payments based on whether you have a new or used Mercedes-Benz.

With Service Care we guarantee the price of parts and labour for up to four services and safeguard against any further inflation. It also covers the cost of any additional items including brake fluid, spark plugs, air filters, fuel filters and screen wash.

You can choose either to add your servicing costs into your monthly spend or pay the full amount in a one-off payment, giving you peace of mind that they are taken care of for the period of the plan.

To receive a personalised Service Care plan recommendation visit the Service Care Calculator at [servicecarerates.mercedes-benz.co.uk](http://servicecarerates.mercedes-benz.co.uk)

## Warranty and breakdown cover

Every Mercedes-Benz comes with a three-year unlimited mileage warranty against manufacturing or material defects<sup>1</sup> and up to 30 years warranty against perforation due to corrosion from the inside out.<sup>2</sup> What's more, it's also covered by Mercedes-Benz Roadside Assistance – a unique package comprising up to 30 years pan-European breakdown assistance.<sup>2</sup>

## Insurance

Since our name is synonymous with reliability, who better to trust with your motor insurance? Mercedes-Benz Insurance provides a motor insurance policy specifically designed to give you the cover you would expect from Mercedes-Benz. For a motor insurance quotation, call **0345 600 2180**.\*

# The Mercedes that thinks and acts for you.

## Imagine if...

### ...you could connect with your Mercedes-Benz?

With Mercedes me connect, you can; with Remote Online services<sup>1</sup> that include trip planning, maintenance management and vehicle tracking, plus more.

Getting connected is easy. Just set up your Mercedes me account and get in touch with your Mercedes-Benz Retailer to connect your vehicle to your profile to access your Mercedes me connect services.

### ...you knew beforehand that you need to stop for fuel?

Simply check the fuel level and mileage range from your phone wherever you are. You can also check tyre pressure and washer fluid level. (For electric cars, you can check battery charge state.)

### ...your Mercedes could tell you where it's parked?

You no longer need to ask yourself where you left your car; with Mercedes me connect you can locate your car from your smartphone or tablet within a mile radius.



1. PARKED VEHICLE LOCATOR  
2. VEHICLE TRACKER

3. REMOTE RETRIEVAL OF VEHICLE STATUS  
4. PRE-ENTRY CLIMATE CONTROL FOR ELECTRIC DRIVE AND PLUG-IN HYBRID



### ...you could lock your Mercedes, even if you're miles away?

The uncertainty of whether you've forgotten to lock the car is only human. To make sure your Mercedes-Benz is safe and secure, you can simply lock the car remotely via your PC/Mac, tablet or smartphone.

### ...your Mercedes told you when your service is due?

Being connected means essential data is constantly sent to your Mercedes-Benz Retailer so they know when it is time for a service. Your Retailer can then contact you with a tailor-made service quote.

### ...your Retailer already knows which parts need replacing?

As surprising as this sounds, with teliagnostics your Retailer can recognise remotely if certain parts are due for replacement, contacting you to book an appointment and making sure the relevant parts are in stock when you arrive, getting you back on the road as quickly as possible.

### ...you could just push a button to deal with a breakdown?

Should your car break down, with a simple press of the button everything is taken care of – from breakdown assistance to vehicle recovery.

### ...your Mercedes called for help?

Your Mercedes comes with an SOS button. Press it if you need urgent help and you will be contacted by the emergency response centre.<sup>2</sup> In the event of an accident where airbags or seatbelt tensioners have been activated, a call is placed automatically. Your GPS position is sent to the response teams to initiate rescue efforts.<sup>3</sup>

### The Mercedes that thinks and acts for you.

Contact your Retailer to get connected, or go to [www.mercedes.me](http://www.mercedes.me) for more details.

<sup>1</sup>This is available as an option in conjunction with Audio 20 CD, and standard with COMAND Online. Remote Online is standard with electric drive and plug-in hybrid. Use of the Remote Online equipment option is limited to three years from first registration of the vehicle and can then be extended at extra cost.

<sup>2</sup>A call is placed via the car's sim card, rather than the customer relying on their mobile phone.

<sup>3</sup>This feature is still available to customers without Mercedes me connect services. The customer is not required to accept the terms and conditions on the portal to activate this feature. For all other features the customer will have to accept terms and conditions on the portal to activate them.

# Mercedes-Benz Finance

## Why should you finance with Mercedes-Benz?

At Mercedes-Benz we believe a great driving experience should be matched by an equally great ownership experience. That is why we put just as much thought, time and effort into designing our finance options, our service plans and our insurance cover as we do into our vehicles.

We are not in the business of simply providing a loan to fund the purchase of your dream vehicle. We look on it as a journey that we take with you, from the moment you choose your new Mercedes-Benz, to helping you in choosing your next one.

If you would like to find out more about any of our current offers, simply call into your local Mercedes-Benz Retailer where one of our Business Managers will be more than happy to talk you through anything you need to know.

## Helping you find the right solution.

You should find our finance packages are more convenient than a traditional personal loan because:

- Funds are immediately available – no waiting for cheques or loans to clear.
- There is no security required – either against your home or other assets.
- We have clear and transparent rates – the APR we quote is the APR you get.
- We have friendly Business Managers – experts in vehicle finance who can talk you through all of your plans in detail.

One of our most popular finance products is Mercedes-Benz Agility (our Personal Contract Purchase product). We also offer Contract Hire, Operating Lease and Hire Purchase solutions. If you would like to find out more about these speak to your Retailer or visit [www.mercedes-benz.co.uk/fandi](http://www.mercedes-benz.co.uk/fandi).

## Mercedes-Benz Agility (our PCP product).

At the start of an Agility agreement, you put down a deposit and decide the term of your agreement and your annual mileage. You will be advised of the Guaranteed Future Value, which offers you the reassurance of knowing exactly what you will need to pay to own the vehicle outright in the future (this is known as the Optional Purchase Payment).

Throughout your agreement you simply pay your agreed monthly payments and when the agreement comes to an end you either purchase, hand back or part-exchange your vehicle.



### Agility features:

- Fixed regular payments mean you can easily budget.
- Payments are based only on a proportion of the vehicle's value, keeping your monthly payments lower.
- Our Guaranteed Future Value avoids the risk of unplanned depreciation of your vehicle.
- You defer your ownership decision until the end of the agreement.

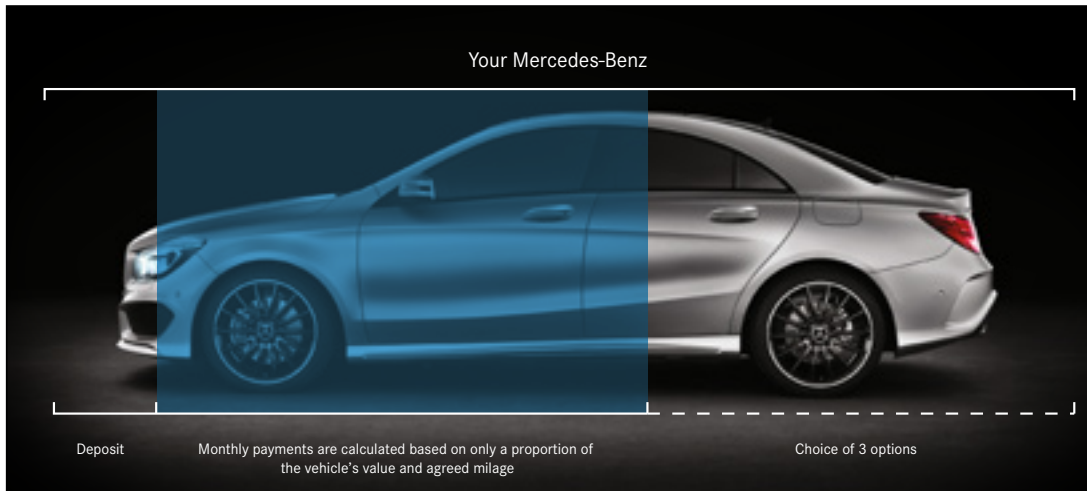

### At the end of your agreement you have three options to choose from.

#### Option 1: Purchase your Mercedes-Benz.

Purchase your Mercedes-Benz by paying the Optional Purchase Payment and Purchase Activation Fee.<sup>1</sup> This will complete the purchase of your Mercedes-Benz, leaving you free to simply enjoy your vehicle.

#### Option 2: Hand back your Mercedes-Benz.

If you decide to return your vehicle to us, it must be in line with our Vehicle Return Standards,\* as vehicle condition, excess mileage and other charges may be payable.

#### Option 3: Part-Exchange for a new vehicle.

Purchase your Mercedes-Benz by paying the Optional Purchase Payment and Purchase Activation Fee.<sup>1</sup> This will complete the purchase of your Mercedes-Benz, leaving you free to part-exchange for a new vehicle.

<sup>1</sup>Please note the 'Purchase Activation Fee' of £10 will be debited from your account \*To find out more information about our Vehicle Return Standards please visit <http://mercedes-benz.co.uk/vrs>

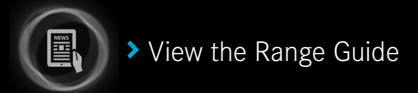
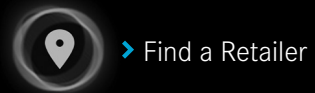
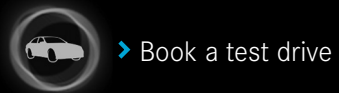

Follow us on the following social media channels:

 <https://www.facebook.com/MercedesBenzUK>

 <https://twitter.com/mercedesbenzUK>

 <https://www.youtube.com/mercedesbenzUK>

 <https://instagram.com/mercedesbenzUK>

Effective from 1 April 2016. Information correct at time of publication.  
Prices and specifications are subject to change without prior notice.  
MBC205PL/0416