



> View offers



> Book a test drive



> Find a Retailer



> View the Range Guide

# GLC

Sport Utility Vehicle



Effective from 1 December 2016 Production.

Mercedes-Benz



# Contents

Model prices	8	Standard equipment	25	Technical data	46
Finance offers	9	Wheels	30	Road Fund Licence	50
SE, Sport and AMG Line	13	Lane Tracking package	33	Services and benefits	51
Executive equipment line	19	Driving Assistance package	34	Mercedes me	52
Mercedes-AMG GLC 43 4MATIC	20	Night package	35	Mercedes-Benz Finance and Insurance	54
Premium and Premium Plus equipment lines	22	Off-Road package	36		
Pricing summary for model and equipment lines	24	Optional equipment	37		
		Colours and materials	42		

## The hard facts to melt your heart

At Mercedes-Benz we appreciate the importance of detail. Over the following pages you'll find model prices and a breakdown of standard and optional equipment, as well as details of the comprehensive services and benefits that are available to every Mercedes-Benz driver.

See Mercedes-Benz in a new light. Now is the time to get yourself behind the wheel of a GLC. Choose from a number of attractive finance offers. Please see pages 9-12 for further details, or visit [www.mercedes-benz.co.uk/offers](http://www.mercedes-benz.co.uk/offers)

Of course, some things have to be experienced to be truly appreciated, such as the qualities that set a Mercedes-Benz apart. Which is why we'd like to invite you for a test drive at your local Mercedes-Benz Retailer. Alternatively, you can make arrangements by visiting [www.mercedes-benz.co.uk/testdrive](http://www.mercedes-benz.co.uk/testdrive)

For more information visit [www.mercedes-benz.co.uk](http://www.mercedes-benz.co.uk) or call 0333 222 0500.



> View offers



> Book a test drive



> Find a Retailer



> View the Range Guide



Some of the model features, optional extras and colours shown may not be available, or may only be available in a different specification.



> View offers



> Book a test drive



> Find a Retailer



> View the Range Guide



Some of the model features, optional extras and colours shown may not be available, or may only be available in a different specification.



> View offers



> Book a test drive



> Find a Retailer



> View the Range Guide



Some of the model features, optional extras and colours shown may not be available, or may only be available in a different specification.



> View offers



> Book a test drive



> Find a Retailer



> View the Range Guide



Some of the model features, optional extras and colours shown may not be available, or may only be available in a different specification.



# Model prices

Engine	Model line	Transmission	CO <sub>2</sub>	Basic RRP excl. VAT (£)	Total RRP incl. VAT (£)	Road Fund Licence (£) <sup>1</sup>	Rec. OTR price (£) <sup>2</sup>	P11D value (£)	BiK tax rate 2016/17 (%)
<b>GLC 220 d 4MATIC</b> Diesel – 2,143 cc, 4-cylinder, 170 hp/125 kW	SE	9G-TRONIC PLUS 9-speed automatic	129	29,466.67	35,360.00	0.00	36,030.00	35,975.00	25
	Sport	9G-TRONIC PLUS 9-speed automatic	129	31,129.17	37,355.00	0.00	38,025.00	37,970.00	25
	AMG Line	9G-TRONIC PLUS 9-speed automatic	129	32,375.00	38,850.00	0.00	39,520.00	39,465.00	25
<b>GLC 250 d 4MATIC</b> Diesel – 2,143 cc, 4-cylinder, 204 hp/150 kW	SE	9G-TRONIC PLUS 9-speed automatic	129	30,429.17	36,515.00	0.00	37,185.00	37,130.00	25
	Sport	9G-TRONIC PLUS 9-speed automatic	129	32,091.67	38,510.00	0.00	39,180.00	39,125.00	25
	AMG Line	9G-TRONIC PLUS 9-speed automatic	129	33,337.50	40,005.00	0.00	40,675.00	40,620.00	25
<b>GLC 350 d 4MATIC</b> Diesel – 2,987 cc, 6-cylinder, 258 hp/190 kW	SE	9G-TRONIC PLUS 9-speed automatic	159	33,983.33	40,780.00	185.00	41,635.00	41,395.00	28
	Sport	9G-TRONIC PLUS 9-speed automatic	159	35,645.83	42,775.00	185.00	43,630.00	43,390.00	28
	AMG Line	9G-TRONIC PLUS 9-speed automatic	159	36,891.67	44,270.00	185.00	45,125.00	44,885.00	28
<b>Mercedes-AMG GLC 43 4MATIC</b> Petrol – 2,996 cc, 6-cylinder, 367hp/270kW	-	9G-TRONIC PLUS 9-speed automatic	189	39,416.67	47,300.00	500.00	48,470.00	47,915.00	34

<sup>1</sup> A different first year rate of Vehicle Excise Duty (Road Fund Licence) applies for new cars. Please refer to page 50 for the relevant rate for the second and subsequent years

<sup>2</sup> Recommended on-the-road price: these prices reflect the Road Fund Licence applicable to the standard model plus £670.00 additional costs necessary to put your car on the road. Included are a standard UK delivery charge (£540.00 incl. VAT), new vehicle registration fee (£55.00), number plates (£25.00 incl. VAT) and fuel (£50.00 incl. VAT). VAT is calculated at the standard rate of 20%. A different first year rate of Vehicle Excise Duty (Road Fund Licence) applies for new cars





> View offers



> Book a test drive



> Find a Retailer



> View the Range Guide

# Mercedes-Benz Finance

Even the finance offer is beautifully put together

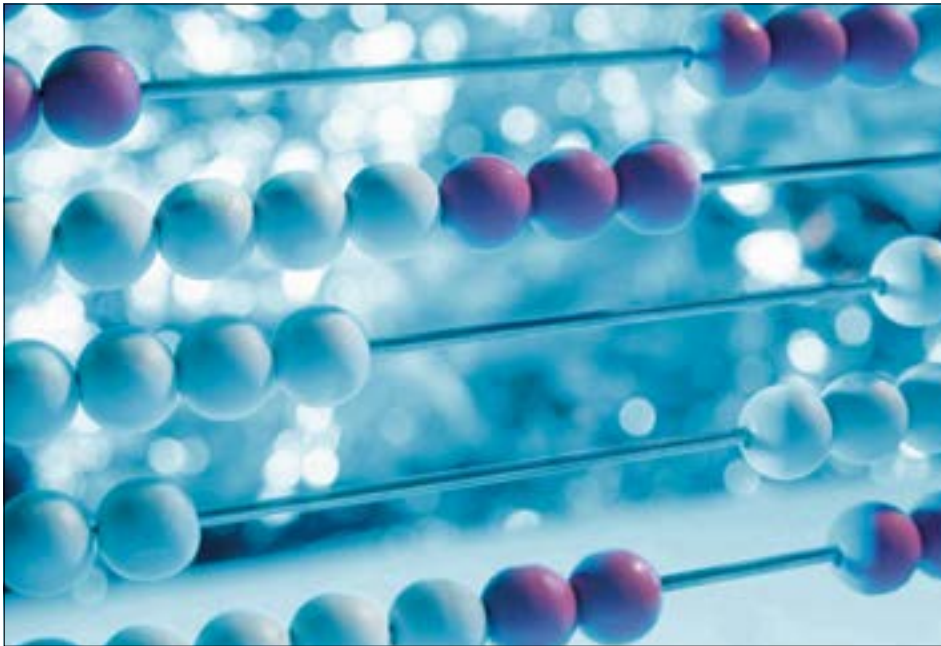

## GLC 220d 4MATIC AMG Line with optional metallic paint (representative example)

36 monthly payments of <sup>1</sup>	£419.00
Customer deposit	£7,125.57
On-the-road price	£39,715.00
Optional purchase payment <sup>2</sup>	£22,150.00
Amount of credit	£32,589.43
Duration of agreement	36 months
Total amount payable <sup>3</sup>	£44,369.57
Purchase activation fee <sup>2</sup>	£10.00
APR	5.5%
Fixed interest rate	5.32%
Excess mileage	10p per mile



### Example offers – 5.5% APR Representative

	Automatic	Metallic	On-the-road price	Customer deposit	36 monthly payments of <sup>1</sup>
GLC 220 d 4MATIC SE	●	○	£36,225.00	£6,608.65	£359.00
GLC 250 d 4MATIC AMG Line	●	○	£40,870.00	£7,278.54	£419.00

● Standard equipment ○ Optional equipment included in the price

### Mercedes-Benz Service Care

- Mercedes-Benz trained Technicians
- Maintained by Mercedes-Benz Retailers
- Meets requirements of Mercedes-Benz Agility finance agreement

### Mercedes-Benz Motor Insurance

- 24/7 UK accident recovery
- We use Mercedes-Benz GenuineParts
- To qualify for up to 10% discount online, go to [www.mercedes-benz.co.uk/motorinsurance](http://www.mercedes-benz.co.uk/motorinsurance)
- Alternatively, call Mercedes-Benz Motor Insurance now on **0345 600 2180<sup>4</sup>** for an annual quote

We may decline to quote in some circumstances. Mercedes-Benz Motor Insurance is underwritten by Aviva Insurance Limited

Content relating to finance is promoted by Mercedes-Benz Finance. Your Retailer may offer finance on behalf of other companies.

Orders/credit approvals on selected new GLC models only, between 1 October and 31 December 2016, registered by 31 March 2017; excluding Mercedes-AMG models. Some combinations of features/options may not be available.

Please contact your local Mercedes-Benz Retailer for availability

<sup>1</sup>Based on a Mercedes-Benz Agility agreement. Vehicle condition, excess mileage and other charges may be payable. Quotations available on request for alternative contract lengths and mileages.

Guarantees may be required. Credit provided, subject to status, by Mercedes-Benz Finance, MK15 8BA

<sup>2</sup>Payable if you exercise the option to purchase the car

<sup>3</sup>Includes optional purchase payment, purchase activation fee and Retailer deposit contribution (where applicable) <sup>4</sup>Calls are charged at local rate and may be recorded

# Mercedes-Benz Finance

It comes with a specification list worth exploring

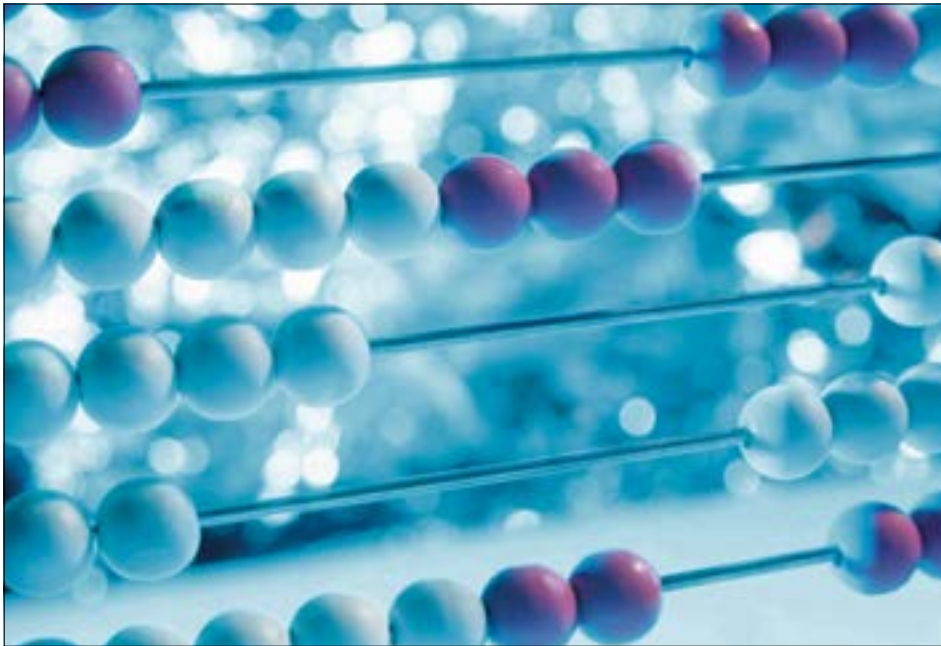

## Mercedes-AMG GLC 43 4MATIC (representative example)

36 monthly payments of <sup>1</sup>	£594.65
Customer deposit	£5,999.00
On-the-road price	£47,875.00
Optional purchase payment <sup>2</sup>	£25,950.00
Amount of credit	£41,876.00
Duration of agreement	36 months
Total amount payable <sup>3</sup>	£53,366.40
Purchase activation fee <sup>2</sup>	£10.00
APR	5.5%
Fixed interest rate	5.32%
Excess mileage	10p per mile

**Example offer – 5.5% APR Representative**

	Automatic	Metallic	On-the-road price	Customer deposit	36 monthly payments of <sup>1</sup>
Mercedes-AMG GLC 43 4MATIC	●	●	£47,875.00	£5,999.00	£594.65

● Standard equipment

### Mercedes-Benz Service Care

- Mercedes-Benz trained Technicians
- Maintained by Mercedes-Benz Retailers
- Meets requirements of Mercedes-Benz Agility finance agreement

### Mercedes-Benz Motor Insurance

- 24/7 UK accident recovery
- We use Mercedes-Benz GenuineParts
- To qualify for up to 10% discount online, go to [www.mercedes-benz.co.uk/motorinsurance](http://www.mercedes-benz.co.uk/motorinsurance)
- Alternatively, call Mercedes-Benz Motor Insurance now on **0345 600 2180<sup>4</sup>** for an annual quote

We may decline to quote in some circumstances. Mercedes-Benz Motor Insurance is underwritten by Aviva Insurance Limited

Content relating to finance is promoted by Mercedes-Benz Finance. Your Retailer may offer finance on behalf of other companies.

Orders/credit approvals on selected Mercedes-AMG GLC 43 4MATIC models only, between 1 October and 31 December 2016, registered by 31 March 2017; excluding non-Mercedes-AMG models. Some combinations of features/options may not be available. Please contact your local Mercedes-Benz Retailer for availability

<sup>1</sup>Based on a Mercedes-Benz Agility agreement. Vehicle condition, excess mileage and other charges may be payable. Quotations available on request for alternative contract lengths and mileages.

Guarantees may be required. Credit provided, subject to status, by Mercedes-Benz Finance, MK15 8BA

<sup>2</sup>Payable if you exercise the option to purchase the car

<sup>3</sup>Includes optional purchase payment, purchase activation fee and Retailer deposit contribution (where applicable)

<sup>4</sup>Calls are charged at local rate and may be recorded

# GLC SE



The GLC SE redefines SUV driving with fluid, dynamic style. The sculpted front is framed by striking headlamps with integrated LED daytime running lamps, while the 17" alloy wheels add to the bold presence. There is also an abundance of intelligent technology: AGILITY CONTROL ensures a well-

balanced ride, while DYNAMIC SELECT allows you to choose between driving modes. Beyond the privacy glass, you'll find a stylish interior with ARTICO leather<sup>1</sup> upholstery. The touchpad with multi-touch control gives you convenient access to the Audio 20 CD with 7-inch colour display.

#### Exterior

17" alloy wheels – 5-twin-spoke, painted tremolite grey

AGILITY CONTROL comfort suspension

COLLISION PREVENTION ASSIST PLUS

DYNAMIC SELECT with a choice of five driving modes

EASY-PACK automatic powered tailgate

Headlamps – halogen with integrated LED daytime running lamps

Privacy glass – dark glass from B-pillar backwards

Rain-sensing windscreen wipers

Reversing camera

Roof rails – aluminium finish

Steering – Direct-Steer speed-sensitive

#### Interior

Stowage package – including retaining net on luggage compartment floor, collapsible box, lockable luggage compartment floor and power release for rear seat backrests

Audio 20 CD with 7-inch colour display

DAB digital radio tuner

KEYLESS-GO starting function

Pre-wiring for Garmin® MAP PILOT navigation system

Seats – front, full electric adjustment (backrest, height and seat cushion inclination) with four-way electric lumbar support and manual seat cushion depth adjustment (6 cm)

SPEEDTRONIC cruise control

Steering wheel – 3-spoke multi-function steering wheel, trimmed in leather, with gearshift paddles

THERMATIC – automatic climate control

Touchpad with multi-touch control

Upholstery – velour floor mats in interior colour

#### Trim and Upholstery

High-gloss black

ARTICO leather<sup>1</sup> – black

ARTICO leather<sup>1</sup> – silk beige/black

<sup>1</sup>Man-made leather

# GLC Sport



Exterior features optional tow bar

The GLC Sport is brimming with ingredients to enhance the sporty side of this striking SUV: for sophisticated highlights all round, it comes with chrome trim and bold 18" alloy wheels painted in vanadium silver, as well as a set of eye-catching tailpipes. While the stylish LED High Performance headlamps come with integral LED daytime running lamps, you'll also enjoy smart features once inside. The latest Garmin® MAP PILOT navigation system and the Active Parking Assist with PARKTRONIC and reversing camera will not only help guide you to your destination but also assist you in parking your GLC Sport.

The system helps to find a suitable space to park and actively manoeuvres the vehicle into the space, relieving the driver of steering and braking. Meanwhile, heated front seats and the interior lighting package add to the sophisticated atmosphere on board.

**Sport upgrade** – designed and priced as a package, including all SE equipment plus additional items as listed below.

**Upgrade price (from SE)**

**Total incl. VAT<sup>2</sup> £1,995.00**

**Exterior**

Mirror package – electrically folding mirrors and automatically dimming exterior driver's mirror and rear-view mirror

18" alloy wheels – 5-spoke design, painted vanadium silver

Active Parking Assist with PARKTRONIC and reversing camera

Chrome trim – front, side and rear

Headlamps – LED High Performance Headlamps with integral LED daytime running lamps

Visible tailpipe exhaust trim integrated into rear bumper

**Interior**

Interior Lighting package – lighting of footwells, door handle recesses, as well as rear reading lamps (LED) and courtesy lamps in all doors

Garmin® MAP PILOT navigation system

Seats – front, heated

Trim – black ash wood

**Trim and Upholstery**

Black ash wood



ARTICO leather<sup>1</sup> – black

ARTICO leather<sup>1</sup> – silk beige/black



<sup>1</sup>Man-made leather

<sup>2</sup>Recommended Retail Price: this price will vary according to engine chosen, due to Road Fund Licence





> View offers



> Book a test drive



> Find a Retailer



> View the Range Guide

## GLC AMG Line



The GLC AMG Line takes sportiness to the highest level, courtesy of our AMG performance experts. First, you'll notice the AMG bodystyling and the 19" AMG alloy wheels painted in titanium grey. You'll also enjoy the AMG sports suspension, tuned for dynamic driving. The interior continues the athletic theme with seats in ARTICO leather,<sup>1</sup> AMG sports pedals and AMG floor mats with embroidered 'AMG' lettering. The AMG sports steering

wheel with its flattened bottom section gives you a firm grip and allows for sporty handling.

**AMG Line upgrade** – designed and priced as a package, including all Sport equipment plus additional items as listed below.

**Upgrade price (from Sport)**

**Total incl. VAT<sup>2</sup> £1,495.00**

**Exterior**

- 19" AMG alloy wheels – 5-twin-spoke design, painted titanium grey
- AMG bodystyling – front apron, rear apron and side skirts
- Sports suspension with sporty tuning for improved handling and driving dynamics

**Interior**

- AMG sports pedals in brushed stainless steel with rubber studs
- Instrument cluster with two tube-design round dials
- Steering wheel – 3-spoke multi-function AMG steering wheel in black nappa leather with flattened bottom section, chrome inserts and perforated leather in grip area

- Upholstery – AMG floor mats with edging and embroidered 'AMG' lettering
- Upholstery – ARTICO leather<sup>1</sup>
- Upholstery – black roof lining

**Trim and Upholstery**

Black ash wood

ARTICO leather<sup>1</sup> – black



<sup>1</sup>Man-made leather    <sup>2</sup>Recommended Retail Price: this price will vary according to engine chosen, due to Road Fund Licence

## Executive equipment line



Garmin® MAP PILOT navigation system

The Executive equipment line is designed exclusively for the SE, to let you enjoy each journey that little bit more. It includes the highly sophisticated Garmin® MAP PILOT navigation system, heated front seats and Active Parking Assist with PARKTRONIC.

**Executive equipment line (code DP3)** – designed and priced as a package, including items as listed below.

**SE only**

**Total incl. VAT £1,295.00**

---

**Executive equipment line comprises:**

**Active Parking Assist with PARKTRONIC**

Active Parking Assist controls steering inputs automatically to help you manoeuvre into a parking space. PARKTRONIC's 12 ultrasonic sensors in the front and rear bumpers provide a visible and audible warning to the driver when parking

---

**Garmin® MAP PILOT navigation system**

Operation via controller, touchpad or voice control. SD card navigation with instructions shown on 7-inch high-resolution colour display in the instrument cluster. Includes 3D views with visualisation of roads and buildings as well as junction and lane assistants, making it easy for drivers to orientate themselves. Spoken instructions are emitted through vehicle's built-in speakers. Software and map can be updated online

---

**Heated front seats**

---



> View offers



> Book a test drive



> Find a Retailer



> View the Range Guide

# Mercedes-AMG GLC 43 4MATIC



Exterior features optional metallic paint, 21" AMG alloy wheels and running boards with rubber studs

The first Mercedes-AMG among the GLC line-up and the only petrol model, this V6 GLC 43 4MATIC combines powerful performance with sporty looks. The 'BITURBO 4MATIC' lettering points to all-wheel drive for superior driving dynamics, matched by bicolour 19" AMG alloy wheels in a 5-twin-spoke design. AMG bodystyling, 'AMG' lettering on the front brake calipers and on the distinctive diamond grille also reflect AMG's style in typical athletic

fashion. The interior theme is characterised by an aluminium trim set against black with red highlights. It features red contrast stitching on the ARTICO leather<sup>1</sup>/DINAMICA microfibre sports seats and on the ARTICO leather<sup>1</sup> dashboard, red seat belts and floor mats with black leather edging, AMG logo and red piping.

#### Exterior

- 19" AMG alloy wheels – 5-twin-spoke design, bicolour
- AMG bodystyling – front apron with distinctive air intakes, AMG side sill panels and AMG rear apron with diffuser look
- 'AMG' lettering on front brake calipers
- AMG spoiler lip in vehicle colour
- 'BITURBO 4MATIC' lettering on front wings
- Black mirror housings
- Diamond radiator grille with chrome pins and 'AMG' lettering

#### Interior

- AMG boot logo in central screen
- ARTICO leather<sup>1</sup> dashboard with red contrast stitching
- ARTICO leather<sup>1</sup>/DINAMICA microfibre upholstery with red contrast stitching
- Floor mats – with black leather edging, red piping and AMG logo
- Front door sill panels with 'AMG' lettering
- Red seat belts

#### Trim and Upholstery

- High-gloss black with aluminium door inlays
- ARTICO leather<sup>1</sup>/DINAMICA microfibre – black with red contrast stitching



<sup>1</sup>Man-made leather



> View offers



> Book a test drive



> Find a Retailer



> View the Range Guide

# Premium and Premium Plus equipment lines



Ambient lighting



COMAND Online system



Memory package



Panoramic glass sunroof with electric roller sunblind



Burmester® surround sound system



Traffic Sign Assist

Why not look over our equipment lines to enhance and personalise your choice of the GLC? If you want to increase your comfort and add the best in entertainment to the Sport, AMG Line and Mercedes-AMG GLC 43 4MATIC, the Premium equipment line does just that. The Premium equipment line features ambient lighting; the KEYLESS-GO Comfort package for effortless entry, exit and starting; the Memory package for the front seats; and a panoramic glass sunroof to brighten up the cabin. The Premium Plus equipment line contains the same features as the Premium, plus the highly

sophisticated Burmester® surround sound system and COMAND Online with an 8.4-inch high-resolution colour display, navigation with 3D map display and internet connectivity.

**Upgrade price** – includes all Sport, AMG Line and Mercedes-AMG GLC 43 4MATIC equipment plus additional items as listed below.

<b>Premium</b>	<b>Total incl. VAT £1,695.00</b>
<b>Premium Plus</b>	<b>£2,995.00</b>

Item	Notes	Premium (code DP0)	Premium Plus (code DP1)
Ambient lighting	LED lighting located in door trim, side of centre console, front door sills, cup holders, footwells, door handle recesses and overhead panel. Five dimming levels and three colours: solar (amber), polar (ice blue) and neutral (white)	■	■
KEYLESS-GO Comfort package	Offering automatic powered boot closing, keyless start and hands-free access which allows contactless, fully automatic opening and closing of the boot lid by performing a kicking movement under the rear bumper	■	■
Memory package	Driver's seat, front passenger seat, steering column – electrically adjustable with memory. Includes exterior mirror with parking position	■	■
Panoramic glass sunroof with electric roller sunblind	Consisting of a fixed panoramic glass rear section and an electrically operated sliding glass front section, the glass roof provides additional light and ventilation into the car	■	■
Burmester® surround sound system	13 speakers and a 9-channel amplifier with total output of 590 W (7 × 50 W and 2 × 120 W)	–	■
COMAND Online system	8.4-inch high-resolution colour display, hard disk drive (HDD) navigation with 3D map display, Live Traffic Information and European map data updates free of charge for the first three years. Single CD/DVD, Speed Limit Assist, Traffic Sign Assist and LINGUATRONIC voice control. Mercedes me connect services, emergency call system (eCall) and access to internet sites when vehicle is stationary, plus unrestricted use of Mercedes-Benz apps (internet-enabled mobile phone required). Integrated WLAN hotspot for onboard access of WLAN-enabled devices. Also includes 10 GB music register and MP3 compatibility	–	■



## Pricing summary for model and equipment lines

Model	Transmission	Recommended OTR price (£) <sup>1</sup>										
		SE	SE Executive	Sport	Sport Premium	Sport Premium Plus	AMG Line	AMG Line Premium	AMG Line Premium Plus	Mercedes-AMG	Mercedes-AMG Premium	Mercedes-AMG Premium Plus
<b>GLC 220 d 4MATIC</b>	9G-TRONIC PLUS 9-speed automatic	36,030.00	37,325.00	38,025.00	39,720.00	41,020.00	39,520.00	41,215.00	42,515.00	-	-	-
<b>GLC 250 d 4MATIC</b>	9G-TRONIC PLUS 9-speed automatic	37,185.00	38,480.00	39,180.00	40,875.00	42,175.00	40,675.00	42,370.00	43,670.00	-	-	-
<b>GLC 350 d 4MATIC</b>	9G-TRONIC PLUS 9-speed automatic	41,635.00	42,930.00	43,630.00	45,325.00	46,625.00	45,125.00	46,820.00	48,120.00	-	-	-
<b>Mercedes-AMG GLC 43 4MATIC</b>	9G-TRONIC PLUS 9-speed automatic	-	-	-	-	-	-	-	-	48,470.00	50,165.00	51,465.00

<sup>1</sup>Recommended on-the-road price: these prices reflect the Road Fund Licence applicable to the standard model plus £670.00 additional costs necessary to put your car on the road. Included are a standard UK delivery charge (£540.00 incl. VAT), new vehicle registration fee (£55.00), number plates (£25.00 incl. VAT) and fuel (£50.00 incl. VAT). VAT is calculated at the standard rate of 20%



## Standard equipment



Reversing camera



EASY-PACK automatic powered tailgate



KEYLESS-GO starting function



Lockable luggage compartment floor



THERMATIC automatic climate control



Touchpad and DYNAMIC SELECT



Item	SE	Sport	AMG Line	Mercedes-AMG GLC 43 4MATIC
<b>Transmission and Suspension</b>				
AMG performance 4MATIC with torque distribution of 31:69 (front/rear)	-	-	-	●
4MATIC permanent four-wheel drive	●	●	●	●
9G-TRONIC PLUS 9-speed automatic transmission with steering column gear selector, DIRECT SELECT steering wheel gearshift paddles and SPEEDTRONIC cruise control with variable speed limiter	●	●	●	●
AGILITY CONTROL comfort suspension	●	●	-	-
AIR BODY CONTROL air suspension for front and rear axles with continuously adjustable damping	-	-	-	●
DYNAMIC SELECT with a choice of driving modes: 'Comfort', 'Eco', 'Sport', 'Sport+' and 'Individual'	●	●	●	●
ECO start/stop function	●	●	●	●
Sports suspension tuned for improved handling and driving dynamics	-	-	●	-
<b>Exterior</b>				
Mirror package – electrically folding mirrors and automatically dimming exterior driver's mirror and rear-view mirror	-	●	●	●
Active Parking Assist with PARKTRONIC Active Parking Assist controls steering inputs automatically to help you manoeuvre into a parking space. PARKTRONIC's 12 ultrasonic sensors in the front and rear bumpers provide a visible and audible warning to the driver when parking	△	●	●	●
AMG bodystyling – front apron, rear apron and side skirts	-	-	●	●

Item	SE	Sport	AMG Line	Mercedes-AMG GLC 43 4MATIC
Beltline trim strip and window surround in high-gloss black	-	-	-	●
Brake calipers – with 'AMG' lettering and perforated front brake discs	-	-	-	●
Brake calipers – with 'Mercedes-Benz' lettering and perforated front brake discs	-	-	●	-
Chrome trim – front, side and rear	-	●	●	-
Diesel Particulate Filter (DPF)	●	●	●	-
EASY-PACK powered tailgate The EASY-PACK boot lid can be opened and closed at the touch of a button for more convenient loading and unloading of the boot	●	●	●	●
Exterior mirrors – heated and electrically adjustable	●	●	●	●
Fuel tank – 66-litre	●	●	●	●
Headlamp Assist – automatic headlamp activation	●	●	●	●
Headlamps – halogen with integrated LED daytime running lamps	●	-	-	-
Headlamps – LED High Performance headlamps with integral LED daytime running lamps	-	●	●	●
Heated windscreen washer system	●	●	●	●
Privacy glass – dark glass from B-pillar backwards	●	●	●	●
Radiator grille with integrated star – diamond grille design, chrome pins	-	-	-	●
Radiator grille with integrated star – two chrome-trimmed louvres	-	●	●	-



Item	SE	Sport	AMG Line	Mercedes-AMG GLC 43 4MATIC
<b>Exterior (continued)</b>				
Radiator grille with integrated star – two louvres in matt iridium silver	●	–	–	–
Rain-sensing windscreen wipers	●	●	●	●
Roof rails – aluminium finish	●	●	●	●
Tail lamps – LED	●	●	●	●
Tailpipe trim elements (2) in twin-tailpipe design	–	–	–	●
Tinted glass all round – single-layer safety glass	●	●	●	●
Visible tailpipe exhaust trim integrated into rear bumper	–	●	●	–
<b>Interior</b>				
Interior Lighting package – lighting of footwells, door handle recesses, as well as rear reading lamps (LED) and courtesy lights in all doors, illuminated vanity mirrors	–	●	●	●
Stowage package – including tensioning strap in centre console stowage compartment, two rolled-up fluorescent jackets in stowage pockets in front door panels, map pockets on front seat backs, retaining net on luggage compartment floor, collapsible box, lockable luggage compartment floor, 12 V socket and power release for rear seat backrests	●	●	●	●
EASY-PACK load compartment cover (removable)	●	●	●	●
Electric windows (4) – one-touch opening and closing, including obstruction sensors	●	●	●	●
Floor mats – AMG floor mats with edging and embroidered ‘AMG’ lettering	–	–	●	–
Floor mats – black with ‘AMG’ lettering and red piping	–	–	–	●

Item	SE	Sport	AMG Line	Mercedes-AMG GLC 43 4MATIC
Floor mats – velour mats in interior colour Coloured the same as the car’s appointments, the velour floor mats fit in perfectly with the high-quality interior and effectively protect the footwell against soiling	●	●	–	–
Front door sill panels with ‘AMG’ lettering	–	–	–	●
Front door sill panels with ‘Mercedes-Benz’ lettering	●	●	●	–
Instrument cluster with 5.5-inch TFT multi-function display	●	●	●	●
KEYLESS-GO starting function	●	●	●	●
Outside temperature display, rear seat belt status indicator	●	●	●	●
Seats – front, electric adjustment (backrest, height and seat cushion inclination) with four-way electric lumbar support and manual seat cushion depth adjustment (6 cm)	●	●	●	●
Seats – front, heated	△	●	●	●
Sports pedals in brushed stainless steel with rubber studs	–	–	●	●
Stowage – dividing net for luggage compartment partitioning and occupant protection	●	●	●	●
Stowage – double cup holder in centre console	●	●	●	●
Stowage – illuminated and lockable glove compartment	●	●	●	●
Sun visors with illuminated vanity mirrors	●	●	●	●
THERMATIC – automatic climate control	●	●	●	●

Item	SE	Sport	AMG Line	Mercedes-AMG GLC 43 4MATIC
<b>Steering</b>				
Steering – AMG 2 stage speed-sensitive sports steering	-	-	-	●
Steering – Direct-Steer speed sensitive steering	●	●	●	-
Steering column – manually adjustable for height and reach	●	●	●	●
Steering wheel – 3-spoke multi-function AMG steering wheel in black leather with flattened bottom section and chrome inserts and perforated leather in grip area	-	-	●	-
Steering wheel – 3-spoke multi-function sports steering wheel in black leather with flattened bottom section, deep embossing in grip area and red contrast stitching	-	-	-	●
Steering wheel – 3-spoke multi-function steering wheel, trimmed in leather	●	●	-	-
<b>Paint, Trim and Upholstery</b>				
Paint – non-metallic	●	●	●	●
Trim – black ash wood look	-	●	●	-
Trim – high-gloss black	●	-	-	-
Trim – high-gloss black with aluminium door trims	-	○	○	●
Upholstery – ARTICO leather <sup>1</sup>	●	●	●	-
Upholstery – ARTICO leather <sup>1</sup> dashboard with red contrast stitching	-	-	-	●
Upholstery – ARTICO leather <sup>1</sup> /DINAMICA with red contrast stitching	-	-	-	●





Item	SE	Sport	AMG Line	Mercedes-AMG GLC 43 4MATIC
<b>Safety and Assistance Systems</b>				
Active bonnet – pedestrian safety measure which detects an impact and raises bonnet	●	●	●	●
Adaptive brake lights	●	●	●	●
ADAPTIVE BRAKE system with HOLD function and dry braking in the wet	●	●	●	●
Alarm system with immobiliser and interior protection	●	●	●	●
ATTENTION ASSIST Continuously analyses driver behaviour and steering movements. If patterns are recognised which characterise drowsiness, the driver is prompted to take a break, and an audible warning is sounded	●	●	●	●
Automatic child seat recognition sensor	●	●	●	●
COLLISION PREVENTION ASSIST PLUS The driver is given a visual warning if the distance from a vehicle in front is inadequate. On detecting the danger of a collision there is an acoustic warning, driver braking can be assisted and, if the driver fails to react, the speed can be reduced autonomously. Autonomous partial braking only occurs if the driver fails to react and is travelling at a speed range between 4–65 mph speeds for moving objects and 4–31 mph for stationary objects	●	●	●	●
Dual-stage airbags – driver and front passenger; driver kneebag and windowbags for driver, front passenger and rear passengers	●	●	●	●
Electric parking brake	●	●	●	●





Item	SE	Sport	AMG Line	Mercedes-AMG GLC 43 4MATIC
<b>Safety and Assistance Systems (continued)</b>				
Electronic Stability Programme (ESP®) with Curve Dynamic Assist and Crosswind Assist For greater driving safety and stability, in particular when accelerating on bends; counters understeer by one-sided braking action. Detects sudden, strong gusts of wind and helps the driver stay in lane by means of targeted braking	●	●	●	●
ISOFIX child seat attachment points with top tether in rear (two outer seats)	●	●	●	●
Remote boot release	●	●	●	●
Reversing camera	●	●	●	●
Service indicator ASSYST	●	●	●	●
TIREFIT tyre-sealant kit	●	●	●	●
Tyre pressure monitoring system	●	●	●	●

Item	SE	Sport	AMG Line	Mercedes-AMG GLC 43 4MATIC
<b>Communications and In-Car Entertainment</b>				
Audio 20 CD including touchpad with integrated Media Interface and Bluetooth® interface with hands-free telephony and audio streaming for music transmission	●	●	●	●
DAB digital radio tuner	●	●	●	●
Garmin® MAP PILOT navigation system with Live Traffic Information Operation via controller, touchpad or voice control. SD card navigation with instructions shown on 7-inch high-resolution colour display and in the instrument cluster. Includes 3D views with visualisation of roads and buildings as well as junction and lane assistants, making it easy for drivers to orientate themselves. Spoken instructions are emitted through vehicle's built-in speakers. Software and map can be updated online	△	●	●	●
High-resolution 7-inch multimedia colour display	●	●	●	●
Mercedes me connect (standard services) Including emergency call system (eCall), accident recovery, breakdown and maintenance management	●	●	●	●
Pre-wiring for Garmin® MAP PILOT navigation system	●	●	●	●
Speakers with Frontbass (5)	●	●	●	●
Two USB ports in centre console	●	●	●	●



Item	Notes		SE	Sport	AMG Line	Mercedes-AMG GLC 43 4MATIC	Basic RRP excl. VAT (£)	Total RRP incl. VAT (£)
<b>Wheels (continued)</b>								
19" AMG alloy wheels (4) – 5-twin-spoke design, painted titanium grey 235/55 tyres			638	-	-	●	-	-
19" AMG alloy wheels (4) – 5-twin-spoke design, bicolour 235/55 tyres			RTB 99R	-	-	△	-	Included in Night package
Mercedes-AMG GLC 43 4MATIC front: 235/55 tyres rear: 255/50 tyres				-	-	●		Standard on Mercedes-AMG GLC 43 4MATIC
20" AMG alloy wheels (4) – multi-spoke design, painted titanium grey 255/45 tyres	Not in conjunction with optional Night package (code P55)		688	-	-	○	-	495.83
								<b>595.00</b>

● Standard ○ Optional - Not available △ Available only in conjunction with, or as part of, an option package

Item	Notes		SE	Sport	AMG Line	Mercedes-AMG GLC 43 4MATIC	Basic RRP excl. VAT (£)	Total RRP incl. VAT (£)
<b>Wheels (continued)</b>								
20" AMG alloy wheels (4) – multi-spoke design, bicolour 255/45 tyres  Mercedes-AMG GLC 43 4MATIC front: 255/45 tyres rear: 285/40 tyres	AMG Line: only in conjunction with optional Night package (code P55)		93R	-	-	△	495.83	595.00
			698	-	-	○		
21" AMG alloy wheels (4) – 5-twin-spoke design, bicolour front: 255/45 tyres rear: 285/40 tyres			684	-	-	○	995.83	1,195.00



## Lane Tracking package



Blind Spot Assist



Lane Keeping Assist

The Lane Tracking package includes Blind Spot Assist and Lane Keeping Assist – highly intelligent features to help you stay safe on the road by making the drive more effortless, and to alert you to any emergency.

**Lane Tracking package** (code 22P) – designed and priced as a package, including items as listed below.

**Sport, AMG Line and Mercedes-AMG GLC 43 4MATIC** **Total incl. VAT £595.00**

**Lane Tracking package comprises:**

---

**Blind Spot Assist**  
Visible warning in exterior mirrors if a vehicle is detected in the blind spot; audible warning if indicating to move out of lane

---

**Lane Keeping Assist**  
Vibrates the steering wheel when detecting unintentional drifting out of lane

---

# Driving Assistance package

This comprehensive package includes many advanced features to help keep you safe on the road: Active Blind Spot Assist monitors the obscure area to the side and rear. The innovative driver assistance system DISTRONIC PLUS cruise control helps to automatically maintain a safe distance from the vehicle ahead. Active Lane Keeping Assist is able to recognise when the vehicle is unintentionally drifting out of its lane, and duly warns the driver with pulsed vibrations on the steering wheel. Plus the renowned PRE-SAFE® safety system can detect critical road situations and initiate preventive safety measures.



Active Blind Spot Assist

**Driving Assistance package (code 23P)** – designed and priced as a package, including items as listed below.

**Sport, AMG Line and**

**Mercedes-AMG GLC 43 4MATIC**

**Total incl. VAT £1,695.00**

Item	Notes
Active Blind Spot Assist	Displays a red triangle in the exterior mirrors: when a road user is detected in the blind spot, the red triangle flashes and an audible warning sounds if the driver operates the indicators. Includes course-correcting braking intervention
Active Lane Keeping Assist	Detects signs of inadvertent drifting out of lane and warns the driver by vibrating the steering wheel and, if necessary, will trigger one-sided braking intervention
BAS PLUS with Cross-Traffic Assist	Brake Assist System can lower the risk of rear-end collisions and support the driver during emergency braking by providing additional brake pressure
DISTRONIC PLUS with Steering Assist and Stop&Go Pilot	Helps the driver to maintain a safe distance to the vehicle in front and so relieves strain on the driver, especially on long journeys or in a traffic jam
PRE-SAFE® Brake	Warns the driver if it detects that a rear-end collision is imminent and, if there is no reaction, can take autonomous action to reduce the speed – even to the extent of full brake application



## Night package



How to lend your GLC dramatic effect? Simply add the Night package. Available for the GLC AMG Line and Mercedes-AMG GLC 43 4MATIC, black design details add distinct character to the exterior. Front and rear apron are black entirely, as are the roof rails and weatherstrip. You will also discover the louvres in the front grille to be high-gloss black, as are the exterior mirrors. Viewed from the side and your eyes will naturally be drawn to matching black window strips all round, complemented by 19" bicolour 5-twin-spoke wheels. These wheels are available only when choosing the Night package. Includes two high-gloss black louvres in the radiator grille, high-gloss black exterior mirrors, beltline trim strips, roof rails and weatherstrip.

**Night package (code P55)** – designed and priced as a package, including items as listed below.

**AMG Line and Mercedes-AMG GLC 43 4MATIC Total incl. VAT £495.00**

---

#### Night package comprises:

---

19" alloy wheels (4) – 5-twin-spoke design, bicolour (code 99R) (AMG Line only)

---

Black tailpipe trim in twin-tailpipe design (Mercedes-AMG GLC 43 4MATIC only)

---

Front and rear apron in black

---

Includes two high-gloss black louvres in the radiator grille, high-gloss black exterior mirrors, beltline trim strips, roof rails and weatherstrip

---



## Off-Road package

The Off-Road package combines a host of features that come in handy when taking your GLC off the beaten track. For off-road operation there are options for sand and light terrain, and also for difficult terrain.



Optional running boards and tow bar shown

An underguard for the engine, together with reinforced underfloor panelling the full length of the vehicle, helps to reduce damage caused, for example, by driving over obstacles.

**Off-Road package (code DP9)** – designed and priced as a package, including items as listed below.

**Sport only**

**Total incl. VAT £495.00**

**Off-Road package comprises:**

---

18" alloy wheels (4) – 5-spoke design, painted tremolite grey (code R31)

---

Additional activation of ABS, ESP® and Electronic Traction System (ETS) modes specially configured for off-road terrain

---

Downhill Speed Regulation (DSR), located in centre console behind the Controller, centrally positioned in a chrome surround

---

Front bumper with greater approach angle

---

Guard under engine with reinforced underbody panelling

---

Off-road light function

At speeds up to 31 mph when vehicle is running in off-road driving mode this function allows broader and brighter illumination of the terrain – LED headlamp modules pan outwards by 6°, light is distributed symmetrically and light output is increased

---

Off-road suspension: +20 mm

---

Up to five off-road driving modes: 'Off-road', 'Incline', 'Slippery', 'Trailer' and 'Rocking Assist' (Rocking Assist only in conjunction with optional AIR BODY CONTROL air suspension, code 489)

## Optional equipment



360° camera



AIR-BALANCE package



ARTICO leather<sup>1</sup> dashboard



Head-up display



Running boards



Tow bar

<sup>1</sup>Man-made leather



> View offers



> Book a test drive



> Find a Retailer



> View the Range Guide

Optional equipment

Item	Notes		SE	Sport	AMG Line	Mercedes-AMG GLC43 4MATIC	Basic RRP excl. VAT (£)	Total RRP incl. VAT (£)
<b>Suspension</b>								
AIR BODY CONTROL air suspension for front and rear axles with continuously adjustable damping Damping at each wheel is adapted to the current driving situation, and can be set for more comfortable or sporty characteristics as required		489	○	○	○	●	1,245.83	1,495.00
<b>Exterior</b>								
360° camera Four networked cameras in front grille, wing mirrors and boot capture a 360° bird's-eye view of vehicle's immediate surroundings		501	-	○	○	○	279.17	335.00
Headlamps – LED Intelligent Light System with Adaptive Highbeam Assist Plus LED headlamps, highbeam and direction indicator LED position light, cornering light and daytime running lamps Dynamic headlamp range adjustment for ideal visibility in all weather, lighting and driving conditions Variable light distribution for driving on country roads and motorways as well as in heavy fog Active light function allows headlamps to pivot into bends by up to 15° to illuminate road surface more effectively, improving visibility Cornering light function: two LEDs per headlamp improve road illumination in tight bends by automatically switching on cornering light on the relevant side Enhanced fog lamp function illuminates outer half of the carriageway more effectively while reducing glare due to light reflected by fog. Can be activated at speeds below 44 mph and remains switched on up to 62 mph Welcome home function lights up LED fibre optics in the headlamps in blue after unlocking the vehicle, transitioning to white locator lighting		641	○	○	○	○	454.17	545.00



## Optional equipment

Item	Notes		SE	Sport	AMG Line	Mercedes-AMG GLC 43 4MATIC	Basic RRP excl. VAT (£)	Total RRP incl. VAT (£)
<b>Exterior (continued)</b>								
Running boards with rubber studs		846	<input type="radio"/>	<input type="radio"/>	<input type="radio"/>	<input type="radio"/>	375.00	450.00
Tow bar, fully electric – includes 13-pin socket When ordering, please discuss with your Retailer any specific electrical towing requirements	AMG Line: in conjunction with Premium or Premium Plus equipment line (code DPO or DP1), hands-free access (code 871) is removed	550	<input type="radio"/>	<input type="radio"/>	<input type="radio"/>	<input type="radio"/>	625.00	750.00
<b>Interior</b>								
ARTICO leather <sup>1</sup> dashboard		U09	–	–	<input type="radio"/>	<input checked="" type="radio"/>	333.33	400.00
Head-up display Virtual colour image (21×7 cm) showing driver-related information, such as vehicle speed, directly into the driver's field of vision		463	<input type="radio"/>	<input type="radio"/>	<input type="radio"/>	<input type="radio"/>	687.50	825.00



Item	Notes		SE	Sport	AMG Line	Mercedes-AMG GLC43 4MATIC	Basic RRP excl. VAT (£)	Total RRP incl. VAT (£)
<b>Paint, Trim and Upholstery</b>								
Paint - metallic		'	○	○	○	○	537.50	645.00
Paint - designo metallic		'	○	○	○	○	745.83	895.00
Paint - designo magno		'	○	○	○	○	1,495.83	1,795.00
Trim - AMG carbon fibre with aluminium	Please check with your Retailer for availability	H73	-	○	○	○	454.17	545.00
Trim - black ash wood look		736	-	●	●	○	162.50	195.00
Trim - fineline light brown wood		H24	-	○	○	-	no-cost option	
Trim - high-gloss black with aluminium		739	-	○	○	●	no-cost option	
Upholstery - leather		'	○	○	○	○	662.50	795.00





Item	Notes		SE	Sport	AMG Line	Mercedes-AMG GLC43 4MATIC	Basic RRP excl. VAT (£)	Total RRP incl. VAT (£)
<b>Comfort</b>								
AIR-BALANCE package Interior fragrance dispenser. Fragrance can be changed by exchanging the flasks in the glove compartment. Intensity and duration of fragrance diffusion can be adjusted. Oxygen ionisation and improved filtering system for cleaning the outside air of gaseous emissions such as sulphur dioxide, nitrogen oxides or aromatic hydrocarbons		P21	<input type="radio"/>	<input type="radio"/>	<input type="radio"/>	<input type="radio"/>	291.67	350.00
<b>Communications and In-Car Entertainment</b>								
Mercedes me connect – Remote Online Services	Please see page 52 for further information	05U	<input type="radio"/>	<input type="radio"/>	<input type="radio"/>	<input type="radio"/>	125.00	150.00
<b>Service Package</b>								
Service Care Service Care allows you to spread the cost of servicing your new car in the Mercedes-Benz Retailer network. Taking out a Service Care plan ensures your servicing needs are taken care of by fully trained Mercedes-Benz Technicians with the added benefit of a Mercedes-Benz service history	Price is based on a monthly rate. Example given is for two services taken over 24 months or three services over 36 months. Further payment options are available. New Service Care prices apply only to vehicles up to 12 months old prior to first service. Prices effective from 3 May 2016		<input type="radio"/>	<input type="radio"/>	<input type="radio"/>	<input type="radio"/>	29.16	35.00

# Colours and materials

## Non-metallic paints

Standard



040 black<sup>1</sup>

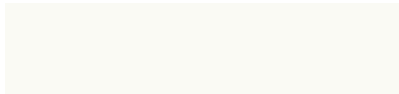

149 polar white

## Metallic paints

Additional-cost option



197 obsidian black



896 brilliant blue



775 iridium silver



988 diamond silver<sup>1</sup>



796 citrine brown



992 selenite grey



890 cavansite blue<sup>1</sup>

## Special metallic paints

Additional-cost option



271 designo citrine brown magno

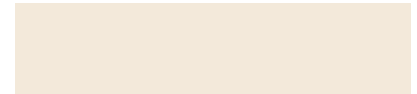

799 designo diamond white bright



996 designo hyacinth red metallic

<sup>1</sup>Not available on Mercedes-AMG GLC43 4MATIC

Please note that, owing to limitations of on-screen representation, paint colours may differ from those shown



**ARTICO man-made leather**

SE, Sport and AMG Line (standard)



101A black



115A silk beige<sup>1</sup>

**ARTICO man-made leather<sup>1</sup>/  
DINAMICA microfibre**

Mercedes-AMG GLC 43 4MATIC (standard)



641A black with red contrast stitching

**Leather**



221A black



235A silk beige<sup>1</sup>



241A black with red contrast stitching<sup>2,3</sup>

**Trim**

Standard and optional<sup>4</sup>



H80 high-gloss black



736 black ash wood look



H73 AMG carbon fibre with aluminium



H24 fineline light brown wood



739 high-gloss black with aluminium

<sup>1</sup>Not available on AMG Line <sup>2</sup>Only available on Mercedes-AMG GLC43 4MATIC <sup>3</sup>Only available with Premium or Premium Plus equipment line (code DP0 and DP1) <sup>4</sup>For detailed availability please refer to optional equipment section on page 40



# Trim and upholstery combinations

	SE, Sport and AMG Line		SE, Sport and AMG Line		Mercedes-AMG GLC 43 4MATIC
	ARTICO leather <sup>1</sup>		Leather		ARTICO leather <sup>1</sup> /DINAMICA microfibre
	black (101A)	silk beige (115A)	black (221A)	silk beige (235A)	black with red contrast stitching (641A)
<b>Dashboard</b>					
Steering wheel	black	black	black	black	black
Upper dashboard trim	black	black	black	black	black with red contrast stitching
Lower dashboard trim	black	silk beige	black	silk beige	black
<b>Seats</b>					
Seat cushion centre section	black	silk beige	black	silk beige	black with red contrast stitching
Side bolster trim	black	silk beige	black	silk beige	black with red contrast stitching
Head restraint	black	silk beige	black	silk beige	black with red contrast stitching
Seat belt	black	black	black	black	red
<b>Doors</b>					
Door trim at beltline	black	black	black	black	black with red contrast stitching
Door centre panel	black	silk beige	black	silk beige	black with red contrast stitching
<b>Roof lining</b>	crystal grey (black <sup>2</sup> )	porcelain	crystal grey (black <sup>2</sup> )	porcelain	black
<b>Floor covering</b>					
Front and rear	black	black	black	black	black
Boot	black	black	black	black	black

<sup>1</sup>Man-made leather    <sup>2</sup>AMG Line



> View offers



> Book a test drive









> Find a Retailer



> View the Range Guide

# Combination options

		Non-metallic paints Standard		Metallic paints Additional-cost option								Special metallic paints Additional-cost option		
		040 black	149 polar white	197 obsidian black	775 iridium silver	796 citrine brown	890 cavansite blue	896 brilliant blue	988 diamond silver	992 selenite grey	271 designo citrine brown magno	799 designo diamond white bright	996 designo hyacinth red metallic	
<b>ARTICO leather<sup>1</sup></b>														
	black	●	●	●	●	●	●	●	●	●	●	●		
	silk beige	●	●	●	●	●	●	●	○	○	●	○		
<b>ARTICO leather<sup>1</sup>/DINAMICA microfibre</b>														
	black with red contrast stitching	●	●	●	●	●	●	●	●	●	●	●		
<b>Leather</b>														
	black	●	●	●	●	●	●	●	●	●	●	●		
	black with red contrast stitching	●	●	●	●	●	●	●	●	●	●	●		
	silk beige	●	●	●	●	●	●	●	○	○	●	○		



# Technical data

Model	Diesel engines			Petrol engine	
	GLC 220 d 4MATIC	GLC 250 d 4MATIC	GLC 350 d 4MATIC	Mercedes-AMG GLC 43 4MATIC	
<b>Engine</b>					
Total displacement	cc	2,143	2,143	2,987	2,996
Arrangement/cylinders/valves		in-line/4/16	in-line/4/16	in-line/6/24	V/6/24
Fuel delivery		Common-rail diesel with turbocharger	Common-rail diesel with turbocharger	Common-rail diesel with twin turbochargers	Electronically-controlled direct injection
Power <sup>1</sup>	hp (kW) at rpm	170 (125)/3,000-4,200	204 (150)/3,800	258 (190)/3,400	367 (270)/5,500-6,000
Torque <sup>1</sup>	Nm at rpm	400/1,400-2,800	500/1,600-1,800	620/1,600-2,400	520/2,000-4,200
Compression ratio		16.2:1	16.2:1	15.5:1	10.5:1
<b>Transmission</b>					
9G-TRONIC PLUS 9-speed auto.		●	●	●	●
<b>Tyre sizes</b>					
Front		235/65 R 17	235/65 R 17	235/65 R 17	235/55 R 19
Rear		235/65 R 17	235/65 R 17	235/65 R 17	255/50 R 19

[View offers](#)[Book a test drive](#)[Find a Retailer](#)[View the Range Guide](#)

Model	Diesel engines			Petrol engine
	GLC 220 d 4MATIC	GLC 250 d 4MATIC	GLC 350 d 4MATIC	Mercedes-AMG GLC 43 4MATIC

**Performance**

Acceleration 0–62 mph	sec	8.3	7.6	6.2	4.9
Top speed	mph	130	138	148	155

**Weights and capacities**

Kerb weight <sup>2</sup>	kg	1,845	1,845	1,890	1,845
Perm. Gross Vehicle Weight	kg	2,500	2,500	2,500	2,460
Towing capacity – unbraked		750	750	750	750
braked	kg	2,500	2,500	2,500	2,460
Boot capacity – max. seats up		550	550	550	550
max. seats down I		1,600	1,600	1,600	1,600
Fuel tank capacity/of which reserve	l	66/7	66/7	66/7	66/7
Turning circle	m	11.8	11.8	11.8	11.8
Wading depth	mm	300	300	300	300

**Fuel consumption<sup>3,4</sup>**

Urban	mpg	51.4	51.4	41.5	26.2
Extra-urban <sup>5</sup>		60.1	60.1	53.3	40.9
Combined		56.5	56.5	47.9	34.0



Model	Diesel engines			Petrol engine
	GLC 220 d 4MATIC	GLC 250 d 4MATIC	GLC 350 d 4MATIC	Mercedes-AMG GLC 43 4MATIC

**CO<sub>2</sub> emissions<sup>4</sup>** g/km

Emissions standard	EU6	EU6	EU6	EU6
17" alloy wheels (235/65 tyres)	129	129	159	-
18" alloy wheels (235/60 tyres)	129	129	159	-
19" alloy wheels (235/55 tyres)	129	129	159	189
20" alloy wheels (255/45 tyres)	129	129	169	199
21" alloy wheels (255/45 tyres)	-	-	-	199

**Insurance**

Base model: SE/Sport/AMG Line	32/34/34	37/39/39	tba	tba
Incl. Executive equipment line	32/-/-	37/-/-	tba	-
Incl. Premium equipment line	-/34/34	-/39/40	tba	tba
Incl. Premium Plus equipment line	-/34/35	-/40/40	tba	tba

Insurance ratings may vary depending on model specification. Please refer to <http://www.thatcham.org/abigrouprating/> for further details

<sup>1</sup>Figures according to Directive 80/1269/EEC in the currently applicable version

<sup>2</sup>Figures according to Directive 92/21/EC (kerb weight with fuel tank 90% full, driver, 68 kg, and luggage, 7 kg) for standard-specification vehicles

<sup>3</sup>All figures are based on a standard specification with the smallest tyre size

<sup>4</sup>The choice of wheels and transmission may affect CO<sub>2</sub> emissions and corresponding Road Fund Licence

<sup>5</sup>EUDC: extra-urban driving cycle. Testing procedures adhere to EU Directive 93/116





> View offers



> Book a test drive



> Find a Retailer



> View the Range Guide

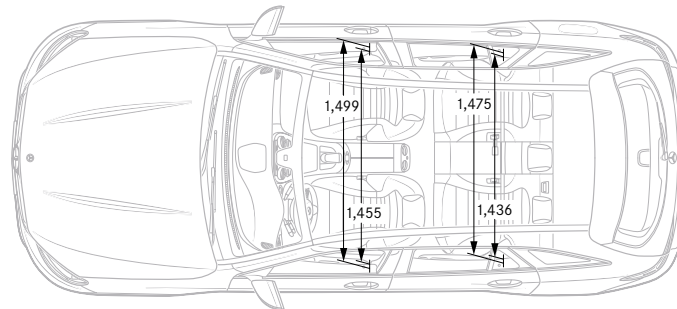
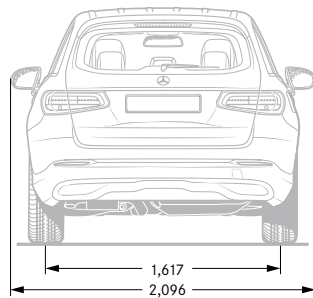
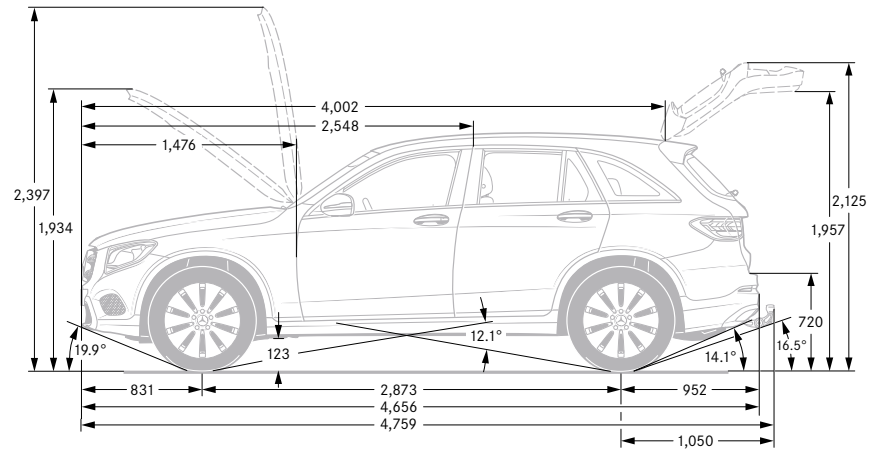
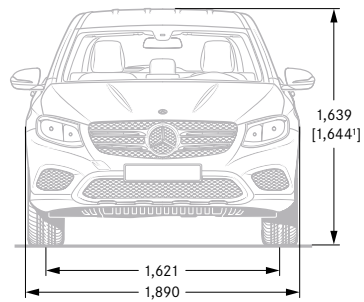

<sup>1</sup>Including roof rails (standard)

The figures on pages 46-49 are correct at time of publication. Please refer to the government website for latest data - <http://carfueldata.direct.gov.uk/>

All measurements in millimetres. The dimensions shown are mean values and apply to standard-specification, unladen vehicles

# Road Fund Licence



All road vehicle registrations are subject to Vehicle Excise Duty (Road Fund Licence), which varies in accordance with the vehicle's CO<sub>2</sub> emissions. A first year rate of Vehicle Excise Duty applies to new cars on their first year of registration. For the second and subsequent years a standard rate for each taxation band will apply.<sup>1</sup> The table below shows the bands (A–M) created by the DVLA and the corresponding Road Fund Licence. CO<sub>2</sub> emissions are listed in the technical data on page 48 and the relevant Excise Duty is reflected in the on-the-road prices on page 8.

Band	CO <sub>2</sub> emissions	First year rate (£)	Standard rate (£)
A	up to 100 g/km	0.00	0.00
B	101 to 110 g/km	0.00	20.00
C	111 to 120 g/km	0.00	30.00
D	121 to 130 g/km	0.00	110.00
E	131 to 140 g/km	130.00	130.00
F	141 to 150 g/km	145.00	145.00
G	151 to 165 g/km	185.00	185.00
H	166 to 175 g/km	300.00	210.00
I	176 to 185 g/km	355.00	230.00
J	186 to 200 g/km	500.00	270.00
K	201 to 225 g/km	650.00	295.00
L	226 to 255 g/km	885.00	500.00
M	over 255 g/km	1,120.00	515.00

Some of the model features, optional extras and colours shown may not be available or may only be available in a different specification.

<sup>1</sup>For further information on vehicle taxation please refer to <http://carfueldata.direct.gov.uk/>

# Services and benefits

## Mercedes-Benz Service Care

We believe that servicing costs should be as flexible and affordable as possible for your new GLC, which is why we offer Service Care, an easy way to budget for all your servicing costs. It spreads your bills into manageable payments based on whether you have a new or used Mercedes-Benz.

With Service Care we guarantee the price of parts and labour for up to four services and safeguard against further inflation. It also covers the cost of all recommended service items including brake fluid, spark plugs, air filters, fuel filters and screen wash.

You can choose either to add your servicing costs into your monthly spend or pay the full amount in a one-off payment, giving you peace of mind that they are taken care of for the period of the plan.

To receive a personalised Service Care plan recommendation visit the Service Care Calculator at [servicecarerates.mercedes-benz.co.uk](http://servicecarerates.mercedes-benz.co.uk)

## Warranty and breakdown cover

Every Mercedes-Benz comes with a three-year unlimited mileage warranty against manufacturing or material defects<sup>1</sup> and up to 30 years warranty against perforation due to corrosion from the inside out.<sup>2</sup> What's more, it's also covered by Mercedes-Benz Roadside Assistance – a unique package comprising up to 30 years pan-European breakdown assistance.<sup>2</sup>

# The Mercedes that thinks and acts for you.

## Imagine if...

### ...you could connect with your Mercedes-Benz?

With Mercedes me connect, you can; with Remote Online services<sup>1</sup> that include trip planning, maintenance management and vehicle tracking, plus more.

Getting connected is easy. Just set up your Mercedes me account and get in touch with your Mercedes-Benz Retailer to connect your vehicle to your profile to access your Mercedes me connect services.

### ...you knew beforehand that you need to stop for fuel?

Simply check the fuel level and mileage range from your phone wherever you are. You can also check tyre pressure and washer fluid level. (For electric cars, you can check battery charge state.)

### ...your Mercedes could tell you where it's parked?

You no longer need to ask yourself where you left your car; with Mercedes me connect you can locate your car from your smartphone or tablet within a mile radius.



1. PARKED VEHICLE LOCATOR  
2. VEHICLE TRACKER

3. REMOTE RETRIEVAL OF VEHICLE STATUS  
4. PRE-ENTRY CLIMATE CONTROL FOR ELECTRIC DRIVE AND PLUG-IN HYBRID

### ...you could lock your Mercedes, even if you're miles away?

The uncertainty of whether you've forgotten to lock the car is only human. To make sure your Mercedes-Benz is safe and secure, you can simply lock the car remotely via your PC/Mac, tablet or smartphone.

### ...your Mercedes told you when your service is due?

Being connected means essential data is constantly sent to your Mercedes-Benz Retailer so they know when it is time for a service. Your Retailer can then contact you with a tailor-made service quote.

### ...your Retailer already knows which parts need replacing?

As surprising as this sounds, with teliagnostics your Retailer can recognise remotely if certain parts are due for replacement, contacting you to book an appointment and making sure the relevant parts are in stock when you arrive, getting you back on the road as quickly as possible.

### ...you could just push a button to deal with a breakdown?

Should your car break down, with a simple press of the button everything is taken care of – from breakdown assistance to vehicle recovery.

### ...your Mercedes called for help?

Your Mercedes comes with an SOS button. Press it if you need urgent help and you will be contacted by the emergency response centre.<sup>2</sup> In the event of an accident where airbags or seatbelt tensioners have been activated, a call is placed automatically. Your GPS position is sent to the response teams to initiate rescue efforts.<sup>3</sup>

### The Mercedes that thinks and acts for you.

Contact your Retailer to get connected, or go to [www.mercedes.me](http://www.mercedes.me) for more details.

<sup>1</sup>This is available as an option in conjunction with Audio 20 CD, and standard with COMAND Online. Remote Online is standard with electric drive and plug-in hybrid. Use of the Remote Online equipment option is limited to three years from first registration of the vehicle and can then be extended at extra cost.

<sup>2</sup>A call is placed via the car's sim card, rather than the customer relying on their mobile phone.

<sup>3</sup>This feature is still available to customers without Mercedes me connect services. The customer is not required to accept the terms and conditions on the portal to activate this feature. For all other features the customer will have to accept terms and conditions on the portal to activate them.

# Mercedes-Benz Finance

## Why should you finance with Mercedes-Benz?

At Mercedes-Benz we believe a great driving experience should be matched by an equally great ownership experience. That is why we put just as much thought, time and effort into designing our finance options, our service plans and our insurance cover as we do into our vehicles.

We are not in the business of simply providing a loan to fund the purchase of your dream vehicle. We look on it as a journey that we take with you, from the moment you choose your new Mercedes-Benz, to helping you in choosing your next one.

If you would like to find out more about any of our current offers, simply call into your local Mercedes-Benz Retailer where one of our Business Managers will be more than happy to talk you through anything you need to know.

## Helping you find the right solution.

You should find our finance packages are more convenient than a traditional personal loan because:

- Funds are immediately available – no waiting for cheques or loans to clear.
- There is no security required – either against your home or other assets.
- We have clear and transparent rates – the APR we quote is the APR you get.
- We have friendly Business Managers – experts in vehicle finance who can talk you through all of your plans in detail.

One of our most popular finance products is Mercedes-Benz Agility (our Personal Contract Purchase product). We also offer Contract Hire, Operating Lease and Hire Purchase solutions. If you would like to find out more about these speak to your Retailer or visit [www.mercedes-benz.co.uk/fandi](http://www.mercedes-benz.co.uk/fandi).

## Mercedes-Benz Agility (our PCP product).

At the start of an Agility agreement, you put down a deposit and decide the term of your agreement and your annual mileage. You will be advised of the Guaranteed Future Value, which offers you the reassurance of knowing exactly what you will need to pay to own the vehicle outright in the future (this is known as the Optional Purchase Payment).

Throughout your agreement you simply pay your agreed monthly payments and when the agreement comes to an end you either purchase, hand back or part-exchange your vehicle.



### Agility features:

- Fixed regular payments mean you can easily budget.
- Payments are based only on a proportion of the vehicle's value, keeping your monthly payments lower.
- Our Guaranteed Future Value avoids the risk of unplanned depreciation of your vehicle.
- You defer your ownership decision until the end of the agreement.

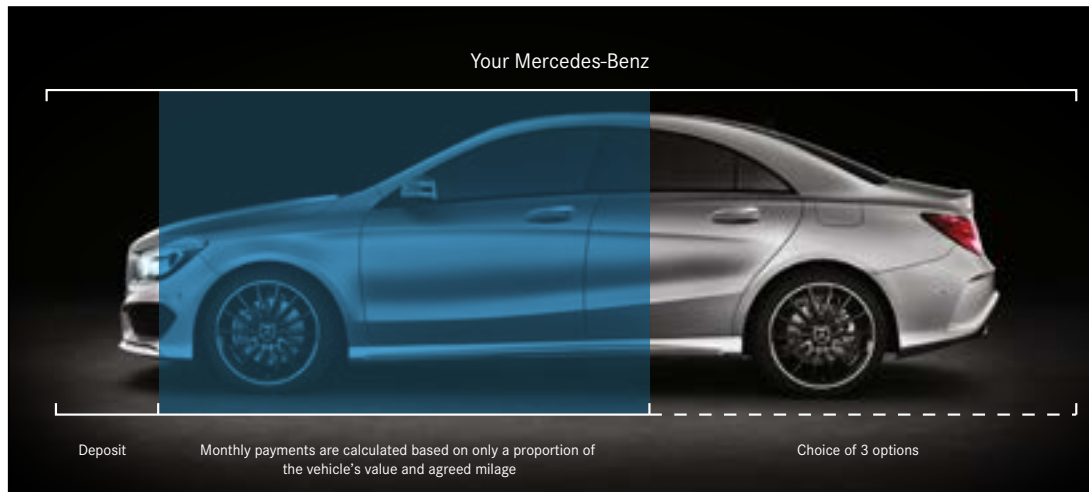

### At the end of your agreement you have three options to choose from.

#### Option 1: Purchase your Mercedes-Benz.

Purchase your Mercedes-Benz by paying the Optional Purchase Payment and Purchase Activation Fee.<sup>1</sup> This will complete the purchase of your Mercedes-Benz, leaving you free to simply enjoy your vehicle.

#### Option 2: Hand back your Mercedes-Benz.

If you decide to return your vehicle to us, it must be in line with our Vehicle Return Standards,\* as vehicle condition, excess mileage and other charges may be payable.

#### Option 3: Part-Exchange for a new vehicle.

Purchase your Mercedes-Benz by paying the Optional Purchase Payment and Purchase Activation Fee.<sup>1</sup> This will complete the purchase of your Mercedes-Benz, leaving you free to part-exchange for a new vehicle.

<sup>1</sup>Please note the 'Purchase Activation Fee' of £10 will be debited from your account \*To find out more information about our Vehicle Return Standards please visit <http://mercedes-benz.co.uk/vrs>



> View offers



> Book a test drive



> Find a Retailer



> View the Range Guide

Follow us on the following social media channels:



<https://www.facebook.com/MercedesBenzUk>



<https://twitter.com/mercedesbenzUK>



<https://www.youtube.com/mercedesbenzUK>



<https://instagram.com/mercedesbenzUK>

Effective from 1 December 2016 Production. Information correct at time of publication.

Prices and specifications are subject to change without prior notice.

MBX253PL/1016

Mercedes-Benz UK Ltd, Tongwell, Milton Keynes, MK15 8BA [www.mercedes-benz.co.uk](http://www.mercedes-benz.co.uk)