

£ > View offers

Book a > test drive > AMG test drive

> Find a Retailer

> View the Range Guide

GLE Coupé



Effective from 1 April 2016.

Mercedes-Benz



Contents

Model prices	10	Pricing summary for Premium and Premium Plus equipment lines	28	Genuine Accessories	46
Finance offers	11	Standard equipment	29	Colours and materials	50
AMG Line, designo Line and 450 AMG 4MATIC	15	Wheels	37	Technical data	54
Premium and Premium Plus equipment lines	21	Driving Assistance Plus package	39	Road Fund Licence	58
Mercedes-AMG GLE 63 S 4MATIC	23	Night package	40	Services and insurance	59
Premium equipment line for Mercedes-AMG GLE 63 S 4MATIC	25	Entertainment package	41	Mercedes me	60
Mercedes-AMG driver training	26	Sports package	42	Mercedes-Benz Finance	62
		Optional equipment	43		



> View offers



Book a > test drive > AMG test drive



> Find a Retailer



> View the Range Guide

The hard facts to melt your heart

At Mercedes-Benz we appreciate the importance of detail. Over the following pages you'll find model prices and a breakdown of standard and optional equipment, as well as details of the comprehensive services and benefits that are available to every Mercedes-Benz driver.

See Mercedes-Benz in a new light. Now is the time to get yourself behind the wheel of a GLE Coupé. Choose from a number of attractive finance offers. Please see pages 11–14 for further details, or visit www.mercedes-benz.co.uk/offers

Of course, some things have to be experienced to be truly appreciated, such as the qualities that set a Mercedes-Benz apart. Which is why we'd like to invite you for a test drive at your local Mercedes-Benz Retailer. Alternatively, you can make arrangements by visiting www.mercedes-benz.co.uk/testdrive

For more information visit www.mercedes-benz.co.uk or call 0333 222 0500.



> View offers



Book a > test drive > AMG test drive



> Find a Retailer



> View the Range Guide





> View offers



Book a > test drive > AMG test drive



> Find a Retailer



> View the Range Guide



Some of the model features, optional extras and colours shown may not be available, or may only be available in a different specification.



> View offers



Book a > test drive > AMG test drive



> Find a Retailer



> View the Range Guide



Some of the model features, optional extras and colours shown may not be available, or may only be available in a different specification.



> View offers



Book a > test drive > AMG test drive



> Find a Retailer



> View the Range Guide





[View offers](#)



[Book a test drive](#) [AMG test drive](#)



[Find a Retailer](#)



[View the Range Guide](#)



Some of the model features, optional extras and colours shown may not be available, or may only be available in a different specification.



[View offers](#)



[Book a test drive](#) [AMG test drive](#)



[Find a Retailer](#)



[View the Range Guide](#)



Some of the model features, optional extras and colours shown may not be available, or may only be available in a different specification.



Model prices

Engine	Model line	Transmission	CO ₂	Basic RRP excl. VAT (£)	Total RRP incl. VAT (£)	Road Fund Licence (£) ¹	Rec. OTR price (£) ²	P11D value (£)	BiK tax rate 2016/17 (%)
GLE 350 d 4MATIC Diesel – 2,987 cc, 6-cylinder, 258 hp/190 kW	AMG Line	9G-TRONIC PLUS ³	187	49,600.00	59,520.00	500.00	60,690.00	60,135.00	37
	designo Line	9G-TRONIC PLUS ³	187	57,345.83	68,815.00	500.00	69,985.00	69,430.00	37
GLE 450 AMG 4MATIC Petrol – 2,996 cc, 6-cylinder, 367 hp/270 kW	-	9G-TRONIC PLUS ³	209	51,241.67	61,490.00	650.00	62,810.00	62,105.00	37
	designo Line	9G-TRONIC PLUS ³	209	58,987.50	70,785.00	650.00	72,105.00	71,400.00	37
Mercedes-AMG									
Mercedes-AMG GLE 63 S 4MATIC Petrol – 5,461 cc, 8-cylinder, 585 hp/430 kW	-	AMG SPEEDSHIFT PLUS 7G-TRONIC PLUS ³	278	78,987.50	94,785.00	1,120.00	96,575.00	95,400.00	37

¹A different first year rate of Vehicle Excise Duty (Road Fund Licence) applies for new cars. Please refer to page 58 for the relevant rate for the second and subsequent years

²Recommended on-the-road price: these prices reflect the Road Fund Licence applicable to the standard model plus £670.00 additional costs necessary to put your car on the road. Included are a standard UK delivery charge (£540.00 incl. VAT), new vehicle registration fee (£55.00), number plates (£25.00 incl. VAT) and fuel (£50.00 incl. VAT). VAT is calculated at the standard rate of 20%. A different first year rate of Vehicle Excise Duty (Road Fund Licence) applies for new cars

³ECO start/stop function and SPEEDTRONIC cruise control as standard

Mercedes-Benz Finance

Where the clever money goes

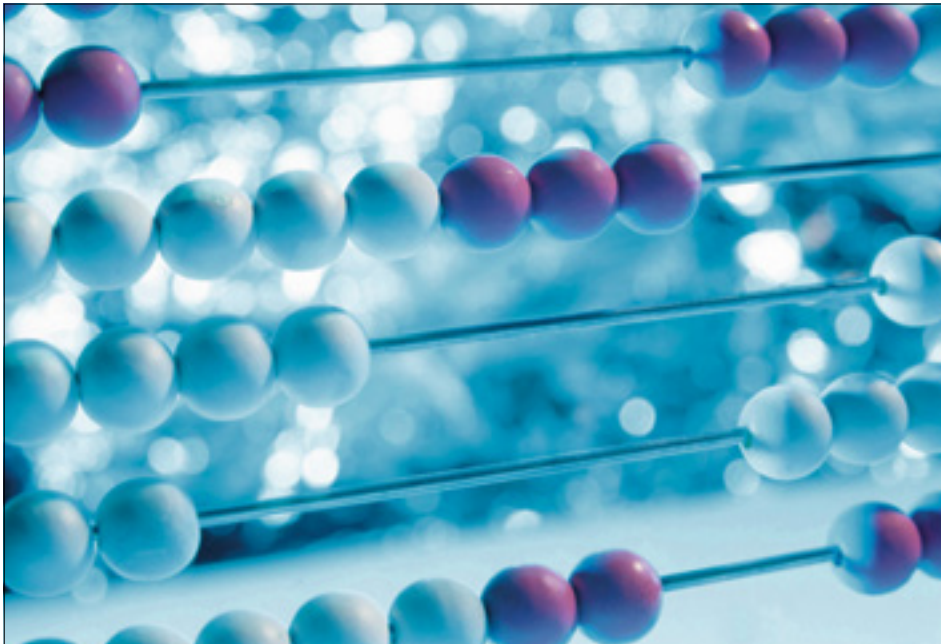

GLE 350 d 4MATIC AMG Line Coupé with automatic transmission and metallic paint (representative example)

36 monthly payments of ¹	£699.00
Customer deposit	£11,200.55
On-the-road price	£60,690.00
Optional purchase payment ²	£31,700.00
Amount of credit	£49,489.45
Duration of agreement	36 months
Total amount payable ³	£68,074.55
Purchase activation fee ²	£10.00
APR	6.2%
Fixed interest rate	5.98%
Excess mileage	10p per mile

**Example offers –
6.2% APR Representative**

	Automatic	Metallic	On-the-road price	Customer deposit	36 monthly payments of ¹
GLE 350 d 4MATIC AMG Line Coupé	●	●	£60,690.00	£11,200.55	£699.00

- Standard equipment

Mercedes-Benz Service Care

- Mercedes-Benz trained Technicians
- Maintained by Mercedes-Benz Retailers
- Meets requirements of Mercedes-Benz Agility finance agreement

Mercedes-Benz Motor Insurance

- 24/7 UK accident recovery
- We use Mercedes-Benz GenuineParts
- To qualify for up to 10% discount online, go to www.mercedes-benz.co.uk/motorinsurance
- Alternatively, call Mercedes-Benz Motor Insurance now on **0345 600 2180**⁴ for an annual quote

We may decline to quote in some circumstances. Mercedes-Benz Motor Insurance is underwritten by Aviva Insurance Limited

Content relating to finance is promoted by Mercedes-Benz Finance. Your Retailer may offer finance on behalf of other companies.

Orders/credit approvals on selected GLE Coupé models only, between 1 April and 30 June 2016, registered by 30 September 2016; excluding Mercedes-AMG GLE 63 Coupé. Some combinations of features/options may not be available. Please contact your local Mercedes-Benz Retailer for availability

¹Based on a Mercedes-Benz Agility agreement. Vehicle condition, excess mileage and other charges may be payable. Quotations available on request for alternative contract lengths and mileages.

Guarantees may be required. Credit provided, subject to status, by Mercedes-Benz Finance, MK15 8BA

²Payable if you exercise the option to purchase the car

³Includes optional purchase payment, purchase activation fee and Retailer deposit contribution (where applicable)

⁴Calls are charged at local rate and may be recorded



Mercedes-Benz Finance

Even the finance offer is beautifully put together

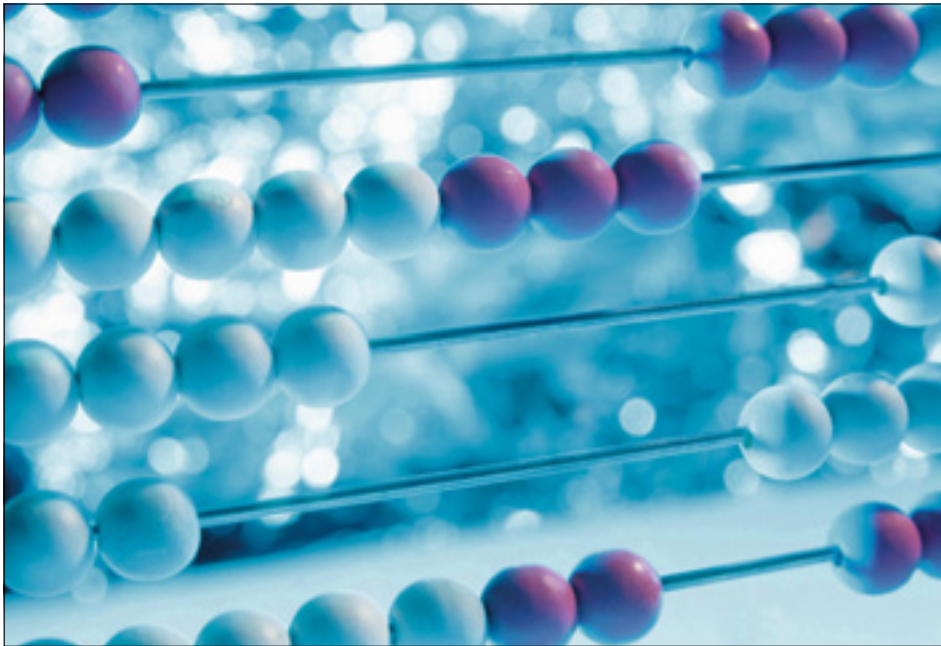

Mercedes-AMG GLE 63 S 4MATIC Coupé with automatic transmission and metallic paint (representative example)

36 monthly payments of ¹	£1,299.00
Customer deposit	£16,842.55
On-the-road price	£96,575.00
Optional purchase payment ²	£44,275.00
Amount of credit	£79,732.45
Duration of agreement	36 months
Total amount payable ³	£107,891.55
Purchase activation fee ²	£10.00
APR	6.2%
Fixed interest rate	5.98%
Excess mileage	14p per mile

**Example offers –
6.2% APR Representative**

	Automatic	Metallic	On-the-road price	Customer deposit	36 monthly payments of ¹
Mercedes-AMG GLE 63 S 4MATIC Coupé	●	●	£96,575.00	£16,842.55	£1,299.00

- Standard equipment

Mercedes-Benz Service Care

- Mercedes-Benz trained Technicians
- Maintained by Mercedes-Benz Retailers
- Meets requirements of Mercedes-Benz Agility finance agreement

Mercedes-Benz Motor Insurance

- 24/7 UK accident recovery
- We use Mercedes-Benz GenuineParts
- To qualify for up to 10% discount online, go to www.mercedes-benz.co.uk/motorinsurance
- Alternatively, call Mercedes-Benz Motor Insurance now on **0345 600 2180**⁴ for an annual quote

We may decline to quote in some circumstances. Mercedes-Benz Motor Insurance is underwritten by Aviva Insurance Limited

Content relating to finance is promoted by Mercedes-Benz Finance. Your Retailer may offer finance on behalf of other companies.

Orders/credit approvals on Mercedes-AMG GLE 63 S 4MATIC Coupé only, between 1 April and 30 June 2016, registered by 30 September 2016; excluding non-Mercedes-AMG models. Some combinations of features/options may not be available. Please contact your local Mercedes-Benz Retailer for availability

¹Based on a Mercedes-Benz Agility agreement. Vehicle condition, excess mileage and other charges may be payable. Quotations available on request for alternative contract lengths and mileages.

Guarantees may be required. Credit provided, subject to status, by Mercedes-Benz Finance, MK15 8BA

²Payable if you exercise the option to purchase the car

³Includes optional purchase payment, purchase activation fee and Retailer deposit contribution (where applicable)

⁴Calls are charged at local rate and may be recorded



[View offers](#)



[Book a test drive](#) [AMG test drive](#)



[Find a Retailer](#)



[View the Range Guide](#)

GLE AMG Line

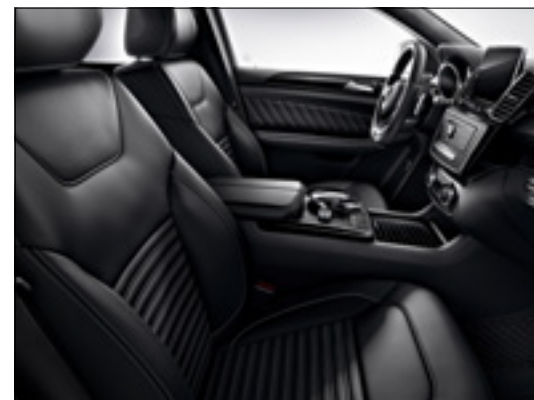

Muscular, innovative, striking SUV dynamics are at the core of the new Mercedes-Benz GLE Coupé. The GLE AMG Line pairs these attributes with an athletic diesel engine, unique AMG styling features and a vast array of technological gems. On the exterior, you'll notice the 21" AMG alloy wheels, AMG bodystyling on front and rear bumpers as well as the beltline trim with chrome-look finish. The interior sets the scene with nappa leather upholstery

and a brushed light aluminium trim. The AMG sports steering wheel also features nappa leather and a flattened bottom rim, plus DIRECT SELECT steering wheel gearshift paddles for the new 9G-TRONIC automatic transmission. AIRMATIC air suspension with Adaptive Damping System Plus and DYNAMIC SELECT with a choice of driving modes to suit the terrain you're in, ensure a highly smooth, yet engaging drive.

Exterior





- Mirror package – including projection of Mercedes-Benz logo integrated into both mirrors
- Active Parking Assist including PARKTRONIC and reversing camera
- AIRMATIC air suspension with Adaptive Damping System Plus
- AMG bodystyling
- DYNAMIC SELECT with a choice of four driving modes
- EASY-PACK powered tailgate
- Headlamps – LED Intelligent Light System
- Privacy glass

- COMAND Online system with multi-touch control touchpad
- DAB digital radio tuner
- Double sun visors with illuminated vanity mirrors
- Front seats – heated
- KEYLESS-GO starting function
- THERMATIC – automatic climate control

Interior

- 3-spoke AMG sports steering wheel in black nappa leather with flattened bottom rim
- Ambient lighting with a choice of three colours: neutral (white), solar (amber), polar (ice blue)
- AMG floor mats with 'AMG' lettering

Trim and Upholstery

Brushed light aluminium	Nappa leather – pearl black/black
	
Nappa leather – pearl black/black with red stitching	Nappa leather – porcelain/black
	



[View offers](#)



[Book a test drive](#) [AMG test drive](#)



[Find a Retailer](#)



[View the Range Guide](#)

GLE designo Line



The designo Line adds a range of exclusive features to the GLE Coupé whilst retaining the AMG Line's distinctive exterior styling. The exterior sports a panoramic electric sunroof, while Active Parking Assist including PARKTRONIC and a 360° camera aids scratch-free parking. The interior stands out with its very own designo Interior package. It includes designo Exclusive

porcelain upholstery, black poplar wood trim, as well as a roof lining in black DINAMICA microfibre. All the seats can be heated, and the multi-contour front seats with massage function are climatized for all-year comfort. This sporty coupé also comes with interior air ionisation with air filter.

Exterior

- Active Parking Assist including PARKTRONIC and 360° camera
- Closing aid for doors and boot lid
- Panoramic electric sunroof with interior sun blind
- Running boards – illuminated, with rubber studs

Interior

- Memory package – including driver's seat, front passenger seat, steering column and exterior mirrors, all electrically adjustable with memory
- designo Interior package
- KEYLESS-GO Comfort package
- Cup holder – temperature controlled, for driver and front passenger
- Front seats – climatized

- Front seats – multi-contour seats with massage function
- Heated multi-function steering wheel
- Interior air ionisation with air filter
- Rear seats – heated
- Surround sound system – Harman Kardon® Logic 7® with Dolby Digital 5.1 and DTS
- THERMOTRONIC – luxury automatic climate control

Trim and Upholstery

- Black poplar wood
- designo Exclusive nappa leather – porcelain/black





[View offers](#)



[Book a test drive](#) [AMG test drive](#)



[Find a Retailer](#)



[View the Range Guide](#)

GLE 450 AMG 4MATIC



The GLE 450 AMG 4MATIC is powered by a highly responsive 6-cylinder petrol engine delivering 367hp (270 kW). The exterior is enhanced with athletic elements like the AMG rear spoiler in vehicle colour, as well as a two-pipe exhaust system with chrome-plated tailpipe trims. Like the diesel model, the GLE 450 AMG 4MATIC also comes with DYNAMIC SELECT, but adds another driving mode, 'Sport+', for a more dynamic ride. Active Parking

Assist including PARKTRONIC and reversing camera are also standard features on this striking GLE Coupé. Inside, the sports seats with AMG bolsters can be fitted with pearl/black or black nappa leather and lugano leather set against brushed light aluminium trim. The sporty theme is matched by the AMG sports steering wheel, AMG floor mats and the instrument cluster with chequered flag design.

Exterior

Mirror package - including projection of Mercedes-Benz logo integrated into both mirrors

Night package

Active Parking Assist including PARKTRONIC and reversing camera

AIRMATIC air suspension with Adaptive Damping System Plus

AMG bodystyling

AMG rear spoiler in vehicle colour on the boot lid

AMG-specific 4MATIC all-wheel drive

AMG sports exhausts with twin tailpipes

DYNAMIC SELECT with a choice of five driving modes

EASY-PACK powered tailgate

Exhaust system with sporty engine including backfire sound

Headlamps - LED Intelligent Light System

Suspension based on Mercedes-AMG model

Interior

3-spoke AMG sports steering wheel in black nappa leather with flattened bottom rim

Ambient lighting with a choice of three colours: neutral (white), solar (amber), polar (ice blue)

DAB digital radio tuner

Double sun visors with illuminated vanity mirrors

Front seats - heated

KEYLESS-GO starting function

THERMATIC - automatic climate control

Trim and Upholstery

Brushed light aluminium

Nappa leather - pearl black/black

Nappa leather - pearl black/black with red stitching

Nappa leather - porcelain/black

Premium and Premium Plus equipment lines



Active Parking Assist including PARKTRONIC and 360° camera



Memory package



Panoramic electric sunroof

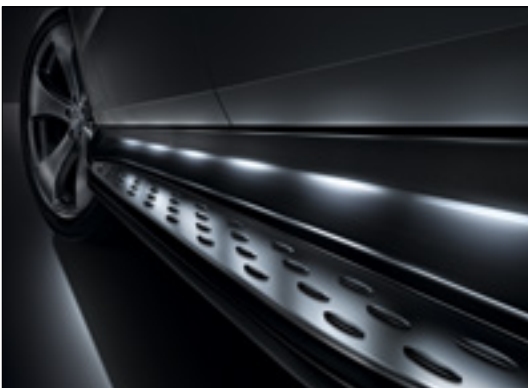

Running boards - illuminated, with rubber studs



Harman Kardon® Logic 7® surround sound system



KEYLESS-GO Comfort package

Once you've decided on a GLE Coupé you will find that it has yet more to offer. True to its name, the Premium equipment line holds a range of features to enhance comfort and convenience. The Premium Plus equipment line maximises your comfort by adding the KEYLESS-GO Comfort package and the Harman Kardon® Logic 7® surround sound system.

Premium and Premium Plus equipment lines¹ – designed and priced as a package, including items as listed below.

Premium equipment line **Total incl. VAT £2,795.00**
Premium Plus equipment line **£3,995.00**

Item	Notes	Premium ¹ £2,795.00 ² (code DPO)	Premium Plus ¹ £3,995.00 ² (code DP1)
Active Parking Assist including PARKTRONIC and 360° camera	Active Parking Assist including PARKTRONIC makes finding a parking space easier, as well as entering or leaving parallel or on-end parking spaces. The 360° camera enables parking and manoeuvring with a realistic all-round view thanks to the interaction of four networked cameras	■	■
Memory package	Driver's seat, passenger seat, steering column and exterior mirrors – electrically adjustable with memory	■	■
Panoramic electric sunroof	Consisting of a fixed panoramic glass rear section and an electrically operated sliding glass front section, allowing additional light and ventilation into the vehicle	■	■
Running boards – illuminated, with rubber studs	Aluminium-look running boards mounted on the side at the height of the side skirts. Slip-resistant rubber studs ensure a firm foothold. Easier to get into both front and rear	■	■
Harman Kardon® Logic 7® surround sound system	Powerful multi-channel DSP amplifier with up to 830 watts as well as 14 high-performance speakers for precision dynamics and excellent sound balance	–	■
KEYLESS-GO Comfort package	The vehicle can be conveniently unlocked, started and locked – simply by carrying the electronic key	–	■



> View offers



Book a > test drive > AMG test drive



> Find a Retailer



> View the Range Guide

Mercedes-AMG GLE 63 S 4MATIC



Image shown includes running boards which are part of the Premium equipment lines

This unique GLE Coupé carries the bold signature of Mercedes' driving performance experts, AMG. Apart from the 'V8 BITURBO' lettering on the front wings, you can't miss the 22" AMG black alloy wheels, the largest ever produced by Mercedes-AMG. The front apron features an A-wing in high-gloss black, a front splitter painted in the vehicle colour, silver chrome inserts and large cooling air intakes. For the most rewarding dynamic drive, there's the AMG sports suspension with Adaptive Damping System and

the ACTIVE CURVE SYSTEM which enhances ride comfort, agility and safety. The interior is brimming with luxurious AMG touches, starting with AMG Exclusive nappa leather upholstery and alpaca grey topstitching on the AMG sports seats, as well as a nappa leather trim. As you'd expect, there's also an AMG performance steering wheel. Plus, the 4.4-inch AMG instrument cluster lights up in red.

Exterior

- Mirror package – including projection of Mercedes-Benz logo integrated into both mirrors
- 22" AMG alloy wheels (4) – multi-spoke design, painted in titanium grey with high-sheen finish
- Active Parking Assist including PARKTRONIC and reversing camera
- AMG sports suspension based on AIRMATIC with ACTIVE CURVE SYSTEM features advanced adjustable damping and roll compensation
- DYNAMIC SELECT with a choice of driving modes
- High-performance braking system with red brake calipers
- Panoramic electric sunroof with interior sun blind
- S-Model AMG front and rear aprons

Interior

- Memory package
- Ambient lighting with a choice of three colours: neutral (white), solar (amber), polar (ice blue)

- AMG floor mats with 'AMG' lettering
- AMG instrument cluster
- AMG performance steering wheel
- Surround sound system – Harman Kardon® Logic 7® with Dolby Digital 5.1 and DTS

Trim and Upholstery

Brushed light aluminium	AMG Exclusive nappa leather – black with grey stitching
AMG Exclusive nappa leather – porcelain/black	AMG Exclusive nappa leather – espresso brown/black

Premium equipment line for Mercedes-AMG GLE 63 S 4MATIC

Given that the GLE Coupé is a thing of beauty in its own right, you might think that there isn't much room for improvement. But if you want to increase the comfort and convenience of your GLE 63 S 4MATIC, the Premium equipment line does just that.

Premium equipment line – designed and priced as a package, including items as listed below.

Mercedes-AMG GLE 63 S 4MATIC

Total incl. VAT £3,295.00

Item	Notes	Premium £3,295.00 ² (code DPO)
Active Parking Assist including PARKTRONIC and 360° camera	Active Parking Assist including PARKTRONIC makes finding a parking space as well as parking in and leaving parallel or on-end parking spaces easier. The 360° camera enables parking and manoeuvring with a realistic all-round view thanks to the interaction of four networked cameras	■
Closing aid for doors and boot lid	When initially engaged, doors and boot lid are automatically closed by servo motors, ensuring smooth and virtually silent closing	■
Front seats – climatized	The active ventilation function of the climate-controlled seats rapidly cools the seat surfaces to a pleasant temperature to ensure well-balanced seating comfort. In cold weather conditions, the on-demand seat heating provides cosy warmth as required	■
Front seats – multi-contour, with massage function	Driver and front passenger can use various air chambers to individually adjust their seats to suit their personal physique – from seat cushion depth via the side bolsters to the position and curvature of the backrest. The massage function with seven zones and two selectable intensity settings helps to avoid muscle tension	■
Interior air ionisation with air filter	This system helps to significantly improve the quality of the air in the vehicle interior. Ionisation has a refreshing effect and can contribute to an enhanced sense of wellbeing. The filter system has two fine-particle activated charcoal filters for a particularly comprehensive reduction of harmful substances and odours	■
KEYLESS-GO Comfort package	The vehicle can be conveniently unlocked, started and locked with this system – simply by carrying the electronic key	■
Running boards - illuminated, with rubber studs	Aluminium-look running boards mounted on the side at the height of the side skirts. Slip-resistant rubber studs ensure a firm foothold. Easier to get into the front and rear	■



> View offers



Book a > test drive > AMG test drive



> Find a Retailer



> View the Range Guide

Exclusive driver training for Mercedes-AMG owners

All Mercedes-AMG customers are invited to a complimentary AMG Driving Academy Training experience at Mercedes-Benz World.



With friendly one-to-one tuition from a professional Mercedes-AMG driver, your training will be personalised to you. You'll push Mercedes-AMG driving performance and your driving skills to the limits on our track and purpose-built low friction dynamic handling facilities.

Through high-speed and adrenaline-fuelled exercises you'll experience oversteer, understeer, slaloms and many more performance driving skills. Designed as part of your ownership experience, this will lay the foundations to master a high-performance vehicle, develop driving skills with maximum enjoyment and prepare you to take full command of your own Mercedes-AMG.

TERMS AND CONDITIONS

The following only are eligible: the first purchaser/registered keeper of a newly-registered Mercedes-AMG; the second owner/registered keeper of a Mercedes-AMG purchased from a Mercedes-Benz Retailer, where the vehicle is less than 90 days from registration. The AMG Driving Academy Training experience is the AMG BASIC-Training as detailed in the further information above and must be booked and taken within six months of delivery of your Mercedes-AMG; it cannot be exchanged and cannot be transferred for any other driving experience. The Training experience is available Monday to Friday only and is subject to availability. Mercedes-Benz UK Limited reserves the right to amend or withdraw this Training experience. Attendees must hold a full UK driving licence. Attendees will be required to sign the Mercedes-Benz World Driving Risk Acknowledgement prior to undertaking the Training experience. The Training experience is also subject to the Mercedes-Benz World Terms and Conditions, as applicable.



> View offers



Book a > test drive > AMG test drive



> Find a Retailer



> View the Range Guide



Pricing summary for Premium and Premium Plus equipment lines

Model	Transmission	Recommended OTR price (£) ¹		
			Premium	Premium Plus
GLE 350 d 4MATIC AMG Line	9G-TRONIC PLUS	60,690.00	63,485.00	64,685.00
GLE 450 AMG 4MATIC	9G-TRONIC PLUS	62,810.00	65,605.00	66,805.00
		Mercedes-AMG	Mercedes-AMG Premium	Mercedes-AMG Premium Plus
Mercedes-AMG GLE 63 S 4MATIC	AMG SPEEDSHIFT PLUS 7G-TRONIC PLUS	96,575.00	99,870.00	-

¹Recommended on-the-road price: these prices reflect the Road Fund Licence applicable to the standard model plus £670.00 additional costs necessary to put your car on the road. Included are a standard UK delivery charge (£540.00 incl. VAT), new vehicle registration fee (£55.00), number plates (£25.00 incl. VAT) and fuel (£50.00 incl. VAT). VAT is calculated at the standard rate of 20%

Standard equipment



Reversing camera



Touchpad



EASY-PACK powered tailgate



Headlamps – LED Intelligent Light System



Mirror package – including projection of Mercedes-Benz logo



KEYLESS-GO starting function



Item	AMG Line	designo Line	450 AMG	Mercedes-AMG
Transmission and Suspension				
9G-TRONIC automatic transmission with steering column gear selector, DIRECT SELECT steering wheel gearshift paddles and SPEEDTRONIC cruise control	●	●	●	-
AMG SPEEDSHIFT PLUS 7G-TRONIC automatic transmission with steering column gear selector, DIRECT SELECT steering wheel gearshift paddles and SPEEDTRONIC cruise control	-	-	-	●
ACTIVE CURVE SYSTEM Enhances ride comfort, agility and safety at high speed, when cornering and when driving off-road	-	-	-	●
AIRMATIC air suspension with Adaptive Damping System	●	●	●	-
AMG sports suspension based on AIRMATIC with Adaptive Damping System	-	-	-	●
DYNAMIC SELECT with a choice of driving modes: 'Comfort', 'Sport', 'Slippery' and 'Individual'	●	●	-	-
DYNAMIC SELECT with a choice of driving modes: 'Comfort', 'Sport', 'Sport+', 'Slippery' and 'Individual'	-	-	●	●
ECO start/stop function	●	●	●	●
Permanent four-wheel drive	●	●	●	●

Item	AMG Line	designo Line	450 AMG	Mercedes-AMG
Steering				
3-spoke AMG sports steering wheel in black nappa leather with flattened bottom rim	●	-	●	-
3-spoke heated multi-function steering wheel	-	●	-	-
4-spoke AMG performance steering wheel in black nappa leather / DINAMICA microfibre	-	-	-	●
Sports Direct-Steer system with speed-sensitive power assistance	●	●	●	●
Steering column - manually adjustable for height and reach	●	-	●	-



Item	AMG Line	designo Line	450 AMG	Mercedes-AMG
Exterior				
Mirror package Including heated exterior mirrors, automatically dimming rear view mirror and exterior mirror on driver's side, electrically folding exterior mirrors left and right, and projection of Mercedes-Benz logo integrated into both mirrors	●	●	●	●
Active Parking Assist including PARKTRONIC and 360° camera Active Parking Assist including PARKTRONIC makes finding a parking space as well as parking in and leaving parallel or on-end parking spaces easier. The 360° camera enables parking and manoeuvring with a realistic all-round view thanks to the interaction of four networked cameras	○	●	○	○
Active Parking Assist including PARKTRONIC and reversing camera PARKTRONIC monitors the front and rear end while the driver is manoeuvring the vehicle and gives a warning if the risk of a collision is detected. Active Parking Assist makes it easier to find a parking space and also automatically steers the vehicle into parking spaces	●	-	●	●
Adaptive Highbeam Assist Plus	●	●	●	●
AMG bodystyling - front and rear bumpers	●	●	●	-
AMG bodystyling with exclusive GLE 63 S 4MATIC front and rear aprons	-	-	-	●
AMG rear spoiler in vehicle colour	-	-	●	●
Beltline trim with chrome-look finish	●	●	-	●
Brake calipers - painted red, with 'AMG' lettering	-	-	-	●

Item	AMG Line	designo Line	450 AMG	Mercedes-AMG
Closing aid for doors and boot lid Power closing ensures smooth and virtually silent closing. Once they have initially engaged, the front and rear doors are automatically drawn closed by servomotors	-	●	-	○
Diesel Particulate Filter (DPF)	●	●	-	-
EASY-PACK powered tailgate The EASY-PACK boot lid can be opened and closed at the touch of a button for more convenient loading and unloading of the boot	●	●	●	●
Exhaust system - twin-pipe, with two integrated black tailpipe trims	-	-	●	-
Headlamps - LED Intelligent Light System LED headlamps, high beam and direction indicator LED position light, cornering light and daytime running lamps Dynamic headlamp range adjustment for ideal visibility in all weather, lighting and driving conditions Variable light distribution for driving on country roads and motorways as well as in heavy fog Active light function allows headlamps to pivot into bends by up to 15° to illuminate road surface more effectively, improving visibility Cornering light function: two LEDs per headlamp improve road illumination in tight bends by automatically switching on cornering light on the relevant side Enhanced fog lamp function illuminates outer half of the carriageway more effectively while reducing glare due to light reflected by fog. Can be activated at speeds below 44 mph and remains switched on up to 62 mph Welcome home function lights up LED fibre optics in the headlamps in blue after unlocking the vehicle, transitioning to white locator lighting	●	●	●	●



Item	AMG Line	designo Line	450 AMG	Mercedes-AMG
Exterior (continued)				
Heated windscreen washer system	●	●	●	●
LED tail lamps	●	●	●	●
Panoramic electric sunroof with interior sun blind	○	●	○	●
Privacy glass – dark glass from B-pillar backwards	●	●	●	●
Rain-sensing wipers	●	●	●	●
Rear screen wash/wiper	●	●	●	●
Running boards – illuminated, with rubber studs	○	●	○	○
Third brake lamp – LED technology	●	●	●	●
Tinted glass all round – single-layer safety glass	●	●	●	●
Underbody protection with chrome-look finish front and rear	●	●	●	●
‘V8 BITURBO’ lettering on front wings	-	-	-	●

Item	AMG Line	designo Line	450 AMG	Mercedes-AMG
Interior				
designo Interior package designo seats with diamond stitching and designo badge, dashboard and door trim in designo leather, roof lining in black DINAMICA microfibre, double sun visors in black DINAMICA microfibre, designo floor mats	-	●	-	-
KEYLESS-GO Comfort package Vehicle can be conveniently unlocked, started and locked with this system – simply by carrying the electronic key	○	●	○	○
Memory package Driver’s seat, front passenger seat, steering column and exterior mirrors – electrically adjustable with memory	○	●	○	●
12 V socket in front and rear of centre console and in load compartment	●	●	●	●
Ambient lighting Illumination for double cup holder, rear footwells, rotary air vent controls, front door sill panels with ‘Mercedes-Benz’ lettering illuminated in white (‘AMG’ lettering for GLE 63 S 4MATIC), warning/courtesy lights in the rear. With a choice of three colours: neutral (white), solar (amber), polar (ice blue)	●	●	●	●
AMG door sill panels in brushed stainless steel with ‘AMG’ lettering	-	-	-	●
AMG floor mats with ‘AMG’ lettering	●	-	●	●
AMG instrument cluster with large (4.4-inch) multi-function display and AMG main menu with red highlights	-	-	-	●



Item	AMG Line	designo Line	450 AMG	Mercedes-AMG
Interior (continued)				
AMG sports seats with AMG-specific seat upholstery layout, optimised lateral support and AMG badge in front seat backrests	-	-	-	●
Centre armrests - front, with stowage compartment	●	●	●	●
Centre armrests - rear, folding	●	●	●	●
Cup holders - front (2) and rear (2)	●	●	●	●
Cup holders - temperature-controlled for driver and front passenger	-	●	-	●
Dashboard - upper part in ARTICO leather ¹	●	-	●	-
Dashboard - upper part in nappa leather	-	●	-	●
Door sill panels with 'Mercedes-Benz' lettering	●	●	●	-
Double sun visors with illuminated vanity mirrors	●	●	●	●
Front seats - full electric adjustment (backrest, height and longitude) with four-way electric lumbar support	●	●	●	●
Front seats - heated	●	-	●	●
Front seats - climatised	-	●	-	○
Front seats - multi-contour seats with massage function	-	●	-	○
Front seats - sports seats with AMG bolsters in nappa leather and lugano leather	●	-	●	-

Item	AMG Line	designo Line	450 AMG	Mercedes-AMG
Head restraints - manually adjustable, front and rear	●	●	●	●
Instrument cluster with chequered flag design	●	-	●	-
Interior air ionisation with air filter	-	●	-	○
KEYLESS-GO starting function	●	●	●	●
Luggage compartment cover	●	●	●	●
Reading lights - front and rear	●	●	●	●
Rear seats - heated	-	●	-	●
Rear seats - split folding 1/3:2/3	●	●	●	●
Sports pedals in brushed stainless steel with rubber studs	●	-	●	●
THERMATIC - automatic climate control	●	-	●	-
THERMOTRONIC - luxury automatic climate control Multi-zone function with separate air distribution settings for driver/front passenger and rear. Three different climate modes: Focused, Medium and Diffuse	-	●	-	●



Item	AMG Line	designo Line	450 AMG	Mercedes-AMG
Paint, Trim and Upholstery				
Paint – non-metallic and metallic	●	●	●	●
Trim – black poplar wood	-	●	-	-
Trim – brushed light aluminium	●	-	●	●
Upholstery – nappa leather	●	-	●	-
Upholstery – designo Exclusive nappa leather	-	●	-	-
Upholstery – AMG Exclusive nappa leather	-	-	-	●

Item	AMG Line	designo Line	450 AMG	Mercedes-AMG
Communications and In-Car Entertainment				
Bluetooth® interface for hands-free telephony and audio streaming for music transmission	●	●	●	●
Central controller dial to operate audio functions and telephone (when connected)	●	●	●	●
COMAND Online system with Media Interface and touchpad ¹ Includes radio, single CD/DVD, 8 speakers, 8-inch colour display, hard disk drive (HDD) navigation with 3D map display, Live Traffic Information and European map data updates free of charge for the first three years and LINGUATRONIC voice control. Internet-enabled mobile phone required for emergency call system (eCall), Mercedes-Benz apps and in-car internet access for Facebook, internet radio, sending routes from Google Maps™ to the vehicle, news and weather reports. Also includes SD memory card slot and MP3 compatibility. Media Interface allows connection and control of portable media devices (e.g. MP3 player, USB storage media)	●	●	●	●
DAB digital radio tuner	●	●	●	●
Mercedes me connect services – for example accident recovery, breakdown management and maintenance management, or telediagnosics for worn parts	●	●	●	●
Remote Online technical preparation for the use of Mercedes me connect services – for example remote query, vehicle status, vehicle location, etc., possible via smartphone	●	●	●	●



Item	AMG Line	designo Line	450 AMG	Mercedes-AMG
Communications and In-Car Entertainment (continued)				
Smartphone integration Comprising Apple CarPlay™. Compatible iPhones (iPhone 5 and newer) can be integrated into the vehicle via Apple CarPlay™. Please check on www.apple.com/uk/ios/carplay/ for compatibility and approved apps. Certain features and apps require a 3G or 4G data connection. Control of features available through voice control and controller on centre console	●	●	●	●
Surround sound system – Harman Kardon® Logic 7® with Dolby Digital 5.1 and DTS 14 high-performance speakers and total output of 830 watts	○	●	○	●
USB ports (2) in centre console	●	●	●	●

Item	AMG Line	designo Line	450 AMG	Mercedes-AMG
Safety and Assistance Systems				
Active bonnet – pedestrian safety measure	●	●	●	–
Adaptive brake lights	●	●	●	●
Airbags – driver and front passenger	●	●	●	●
Airbags – driver’s kneebag	●	●	●	●
Airbags – front sidebags	●	●	●	●
Airbags – windowbags	●	●	●	●
Alarm system with immobiliser and interior protection (MBSS3)	●	●	●	●
AMG high-performance braking system with internally ventilated and perforated brake discs	–	–	–	●
Anti-lock braking system (ABS) with Brake Assist (BAS)	●	●	●	●
ATTENTION ASSIST Continuously analyses driver behaviour and steering movements. If patterns are recognised which characterise drowsiness, the driver is prompted to take a break, and an audible warning is sounded. At the same time COMAND Online offers to locate a rest stop	●	●	●	●
Automatic child seat recognition sensor When the front passenger seat is unoccupied or a child seat is detected, the front passenger airbag is automatically deactivated	●	●	●	●

Item	AMG Line	designo Line	450 AMG	Mercedes-AMG
Safety and Assistance Systems (continued)				
Braking – adaptive Brake Assist with HOLD function and Hill Start Assist	●	●	●	●
Collapsible spare wheel	-	-	-	●
COLLISION PREVENTION ASSIST PLUS The driver is given a visual warning if the distance from a vehicle in front is inadequate. On detecting the danger of a collision there is an acoustic warning, driver braking can be assisted and, if the driver fails to react, the speed can be reduced autonomously. Autonomous partial braking only occurs if the driver fails to react and is travelling at a speed range between 4–65 mph speeds for moving objects and 4–31 mph for stationary objects	●	●	●	●
Crosswind Assist Detects sudden, strong gusts of wind and helps the driver stay in lane by means of targeted braking	●	●	●	●
Downhill Speed Regulation (DSR) with on/off switch and variable speed control	●	●	●	●
Electric parking brake	●	●	●	●
Electronic Stability Programme (ESP®) with Acceleration Skid Control (ASR)	●	●	●	●
First-aid kit and warning triangle	●	●	●	●
Four-wheel Electronic Traction System (4ETS)	●	●	●	●

Item	AMG Line	designo Line	450 AMG	Mercedes-AMG
ISOFIX child seat attachment points in the rear (two outer seats)	●	●	●	●
Outside temperature display, rear seat belt status indicator	●	●	●	●
PRE-SAFE® anticipatory safety system with reversible belt tensioners for driver and front passenger seats, closing function for side windows	●	●	●	●
Remote central locking	●	●	●	●
Service indicator ASSYST	●	●	●	●
TIREFIT tyre-sealant kit	●	●	●	-
Traffic Sign Assist Speed Limit Assist with wrong-way warning function and display of speed limit in instrument cluster	●	●	●	●
Tyre pressure monitoring system	●	●	●	●

A revolution in style

Item	Notes		AMG Line	designo Line	450 AMG	Mercedes-AMG	Basic RRP excl. VAT (£)	Total RRP incl. VAT (£)
Wheels								
21" AMG alloy wheels (4) – 5-twin-spoke design, painted in titanium grey with high-sheen finish front: 275/45 tyres rear: 315/40 tyres			650	●	●	-	-	-
21" AMG bi-colour alloy wheels (4) – 5-twin-spoke design front: 275/45 tyres rear: 315/40 tyres			684	○	○	●	-	Included in Night package
22" AMG bi-colour alloy wheels (4) – 5-twin-spoke design front: 285/40 tyres rear: 325/35 tyres			671	-	-	○	-	Included in Sports package

● Standard ○ Optional - Not available



> View offers





Book a > test drive > AMG test drive



> Find a Retailer



> View the Range Guide

Item	Notes		676	-	-	-	●	Basic RRP excl. VAT (£)	Total RRP incl. VAT (£)
Wheels (continued)									
22" AMG alloy wheels (4) – multi-spoke design, painted in titanium grey with high-shine finish front: 285/40 tyres rear: 325/35 tyres			676	-	-	-	●	-	-
22" AMG alloy wheels (4) – multi-spoke design, matt black front: 285/40 tyres rear: 325/35 tyres			680	-	-	-	○	Included in Night package	

● Standard ○ Optional - Not available

Driving Assistance Plus package

This comprehensive package includes many advanced features to help keep you safe on the road: Active Blind Spot Assist monitors the obscure area to the side and rear. The innovative driver assistance system DISTRONIC PLUS cruise control helps to automatically maintain a safe distance from the vehicle ahead. Active Lane Keeping Assist is able to recognise when the vehicle is unintentionally drifting out of its lane, and duly warns the driver with pulsed vibrations on the steering wheel. Plus the renowned

PRE-SAFE® safety system can detect critical road situations and initiate preventive safety measures.

Driving Assistance Plus package (code 23P) – designed and priced as a package, including items as listed below.

All models

Total incl. VAT £1,695.00

Item	Notes
Active Blind Spot Assist	Displays a red triangle in the exterior mirrors: when a road user is detected in the blind spot, the red triangle flashes and an audible warning sounds if the driver operates the indicators. Includes course-correcting braking intervention
Active Lane Keeping Assist	Detects signs of inadvertent drifting out of lane and warns the driver by vibrating the steering wheel and, if necessary, will trigger one-sided braking intervention
BAS PLUS with Cross-Traffic Assist	Brake Assist System develops additional brake pressure if a critical situation is detected and the driver applies the brakes
DISTRONIC PLUS with Steering Assist and Stop&Go Pilot	Helps the driver maintain the desired distance to the vehicle in front, and helps with lane guidance
PRE-SAFE® Brake	Prompts the driver to take action when the risk of a collision is detected, and can initiate autonomous emergency braking at a speed of up to 30mph
PRE-SAFE® PLUS	Initiates occupant protection measures if a rear-end collision is imminent: activating the hazard lights, reversible seat belt tensioning, adjustment of passenger seat positions and closure of windows



Night package

GLE 350 d 4MATIC



Mercedes-AMG GLE 63 S 4MATIC



The Night package contains striking exterior features increasing the visual appeal of the GLE Coupé. The package features 21" or 22" AMG alloy wheels, AMG bodystyling in high-gloss black as well as high-gloss exterior trim elements.

Night package – designed and priced as a package, including items as listed below.

GLE 350 d 4MATIC

Total incl. VAT £495.00

Mercedes-AMG GLE 63 S 4MATIC

£895.00

Item	Night package ¹ £495.00 ³ (code P55)	Night package ² £895.00 ³ (code P55)
Includes a black radiator grille, black front and rear underguards, black exterior mirrors, black beltline and shoulderline trim strips, black rear trim parts	■	■
21" AMG bi-colour alloy wheels (4) - 5-twin-spoke design (code 684)	■	-
22" AMG alloy wheels (4) - 5-twin-spoke design, painted in matt black (code 680)	-	■

■ Included - Not included ¹Available on GLE 350 d 4MATIC only ²Available on Mercedes-AMG GLE 63 S 4MATIC only ³Including VAT Please note that red brake calipers are standard equipment on Mercedes-AMG GLE 63 S 4MATIC only



Entertainment package



Films on DVD, music or television, the Entertainment package provides passengers in the rear with their very own programme of entertainment. Two 8-inch displays and two sets of headphones ensure brilliant picture and sound quality, and a TV tuner allows for digital TV reception.

Entertainment package – designed and priced as a package, including items as listed below.

All models

Total incl. VAT £2,495.00

Entertainment package (code DP7)

Rear seat entertainment, including two 8-inch displays integrated into the front seat head restraints, a DVD player, two sets of headphones and one remote control

TV tuner for digital TV reception



Sports package



The active suspension stabilisers of the ACTIVE CURVE SYSTEM help reduce the rolling tendency and provides markedly enhanced driving comfort. The system actively influences the stabiliser bars during cornering to keep the torsion moment constant, which allows the vehicle to adapt to every situation. In off-road terrain, the system ensures improved axle articulation by decoupling the two stabiliser bars on the front and rear axles. 22" AMG alloy wheels in gloss black also form part of this package.

Sports package – designed and priced as a package, including items as listed below.

GLE450 AMG 4MATIC

Total incl. VAT £3,495.00

Sports package (code DP8)

22" AMG gloss black alloy wheels (code 671)

ACTIVE CURVE SYSTEM with roll stabilisation



Optional equipment

Item	Notes		AMG Line	designo Line	450 AMG	Mercedes-AMG	Basic RRP excl. VAT (£)	Total RRP incl. VAT (£)
AMG Performance Studio								
AMG Performance package AMG Driver's package – including an increase in restriction of top speed to 175 mph and participation in driver training at the AMG Driving Academy. AMG Performance exhaust system: from emotional to restrained, the sound of the AMG sports exhaust system adapts to the transmission mode selected by the driver by means of variably adjustable exhaust flaps		250	-	-	-	○	955.83	1,195.00
AMG carbon fibre engine cover		B14	-	-	-	○	1,245.83	1,495.00
Exterior								
Lane Tracking package Blind Spot Assist Lane Keeping Assist		22P	○	○	○	○	495.83	595.00
Tow bar – fully electric Includes 13-pin socket	When ordering, please discuss with your Retailer any specific electrical towing requirements	550	○	○	○	○	791.67	950.00
Paint, Trim and Upholstery								
Paint – designo diamond white bright		799	○	○	○	○	704.17	845.00
Paint – designo hyacinth red bright		996	○	○	○	○	704.17	845.00
Roof lining – black fabric	Please check with your Retailer for availability	51U	○	-	○	○	83.33	100.00
Trim – AMG carbon fibre/black piano lacquer		H10	○	-	○	○	1,245.83	1,495.00
			-	○	-	-	916.66	1,100.00

Item	Notes						Basic RRP excl. VAT (£)	Total RRP incl. VAT (£)
			AMG Line	designo Line	450 AMG	Mercedes-AMG		
Paint, Trim and Upholstery (continued)								
Trim – black poplar wood		729	○	●	○	○	329.17	395.00
Trim – brown open-pore ash wood trim		H09	○	-	○	○	329.17	395.00
			-	○	-	-	no-cost option	
Trim – designo black piano lacquer		H21	○	-	○	○	329.17	395.00
			-	○	-	-	no-cost option	
Trim – high-gloss brown eucalyptus wood		734	○	-	○	○	329.17	395.00
			-	○	-	-	no-cost option	
Upholstery – pearl black/black nappa leather with red stitching		821A	○	-	○	-	no-cost option	
Upholstery – porcelain/black nappa leather		855A	○	-	○	-	no-cost option	
Upholstery – porcelain/black Exclusive nappa leather		535A	-	-	-	○	no-cost option	
Upholstery – espresso brown/black Exclusive nappa leather		534A	-	-	-	○	no-cost option	
Communications and In-Car Entertainment								
Bang & Olufsen BeoSound AMG sound system with 14 high-performance speakers and a total output of 1,200 watts	For GLE 350 d AMG Line and GLE 450 AMG 4MATIC only available with Premium Plus equipment line (code DP1). When ordered for Mercedes-AMG GLE 63 S, the collapsible spare wheel is replaced by TIREFIT	811	○	○	○	○	2,912.50	3,495.00

Item	Notes	AMG Line	designo Line	450 AMG	Mercedes-AMG	Basic RRP excl. VAT (£)	Total RRP incl. VAT (£)	
Service Package								
<p>Service Care</p> <p>Service Care allows you to spread the cost of servicing your new car in the Mercedes-Benz Retailer network. Taking out a Service Care plan ensures your servicing needs are taken care of by fully trained Mercedes-Benz Technicians with the added benefit of a Mercedes-Benz service history</p>	<p>Price is based on a monthly rate. Example given is for two services taken over 24 months, three services over 36 months or four services over 48 months. Further payment options are available. New Service Care prices apply only to vehicles up to 12 months old prior to first service. Prices correct up to 30 April 2016</p>	1	○	○	○	-	30.00	36.00
		-	-	-	○	35.00	42.00	



> View offers



Book a > test drive > AMG test drive



> Find a Retailer



> View the Range Guide

Genuine Accessories

We've developed a range of Accessories you can add to help personalise and enhance your GLE Coupé. Your local Mercedes-Benz Retailer can advise on fitting costs of Accessories, where applicable. Further information on our full range of Genuine Accessories can be found on the Mercedes-Benz UK website.



01 | Shallow boot tub

The boot tub is suitable for transporting shopping. The tub shape with its slightly raised edge is precision-tailored to the load area. Made from impact-resistant, non-slip polypropylene, its structured surface holds separately available stowage crate in place. Deep boot tub also available.

Basic RRP £86.50 (excl. VAT) **Total RRP £103.80 (incl. VAT)**

02 | Stowage crate

A secure hold for items which are prone to tip over or slide around, e.g. shopping bags. Adjustable partitioning elements allow crate to be divided into max. four sections. Optimum functionality only in conjunction with shallow boot tub.

Basic RRP £71.67 (excl. VAT) **Total RRP £86.00 (incl. VAT)**



03 | Concertina load sill protector

Protects the rear of the car from scratches when you're loading the vehicle and prevents dirt on the car from getting onto your clothes. Practical design – can be connected to reversible mat, shallow boot tub or deep boot tub.

Basic RRP £32.50 (excl. VAT) **Total RRP £39.00 (incl. VAT)**



04 | Floor mat trays

Robust, washable synthetic material, designed for heavy use. Covers the entire footwell. The raised edges and structured surface help keep the floor clean and dry. With distinctive Mercedes-Benz star logo. Price for 3-piece set.

Basic RRP £130.83 (excl. VAT) **Total RRP £157.00 (incl. VAT)**

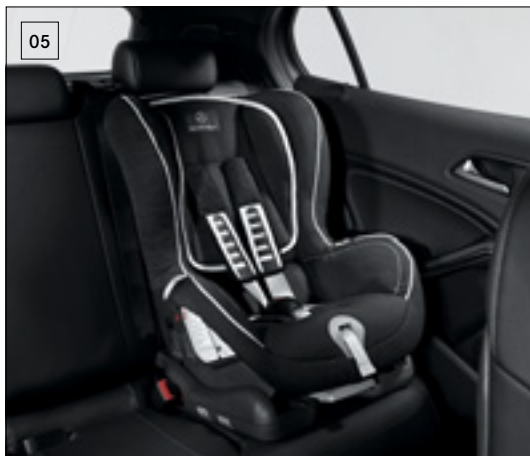

05 | DUO plus child seat, with ISOFIX and automatic child seat recognition

Optimum safety for children between the ages of around 8 months and 4 years (9 to 18 kg). Fitted as standard with top tether, an additional belt for securing the head section, a height-adjustable harness, ventilation channels and ISOFIX attachment points. With automatic child seat recognition. Adjustable tilt. Also available for ages 0+ (1 to 13 kg) and 3.5 to 12 years (15 to 36 kg).

Basic RRP £428.33 (excl. VAT) **Total RRP £449.75 (incl. VAT)**

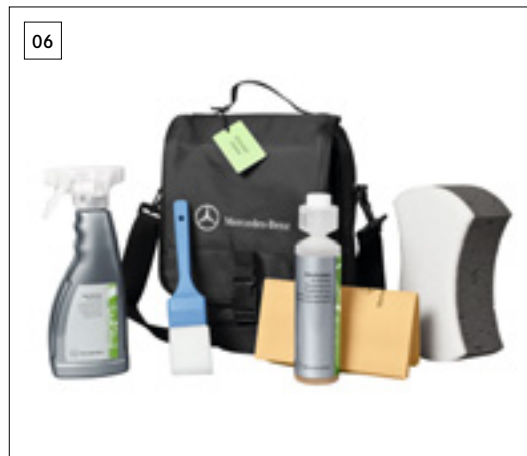

06 | Exterior Car Care Kit

The Mercedes-Benz Exterior Car Care Kit is a four-piece collection to keep the exterior of your car looking like it's come straight from the showroom. The bag contains car shampoo, wheel cleaner, sponge and polishing cloth.

Basic RRP £20.83 (excl. VAT) **Total RRP £25.00 (incl. VAT)**

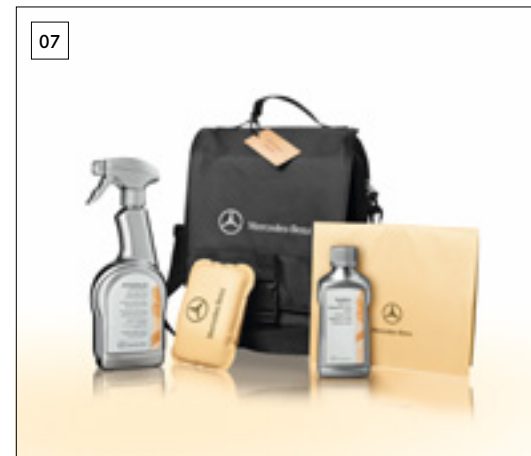

07 | Interior Car Care Kit

The Mercedes-Benz Interior Car Care Kit is a four-piece collection enabling you to maintain a spotless showroom finish inside your car. The bag contains cabin care spray, interior glass cleaner, interior glass sponge and car cloth.

Basic RRP £20.83 (excl. VAT) **Total RRP £25.00 (incl. VAT)**



08 | Winter wheels and tyres

19" alloy wheels (4) – 7-spoke design. With Tyre Pressure Monitor.

Basic RRP £2,480.83 (excl. VAT) **Total RRP £2,977.00 (incl. VAT)**



09 | Winter wheels and tyres

20" alloy wheels (4) – 10-spoke design. With Tyre Pressure Monitor.

Basic RRP £2,729.17 (excl. VAT) **Total RRP £3,275.00 (incl. VAT)**



10 | Mercedes-Benz roof box, 400 litres

Multi-purpose box. Compact length, impressive amount of space. Capacity approx. 400 litres. Opens on both sides. Single lock system. Gas-filled struts for easy opening and closing of lid. Straps to hold contents in place. Maximum load capacity 75 kg. Available in matt silver and black metallic.

Basic RRP £341.67 (excl. VAT) **Total RRP £410.00 (incl. VAT)**



11 | Carrier bars for roof rails

Quick-fastening basic carrier bars for roof rails – no tools required. Multi-functional basis for all Mercedes-Benz transport and leisure accessories such as roof boxes, bicycle racks and ski racks. Locking plastic caps help prevent theft.

Basic RRP £394.00 (excl. VAT) **Total RRP £472.80 (incl. VAT)**

Colours and materials

Non-metallic paint

Standard



149 polar white

Metallic paints

Standard



197 obsidian black



796 citrine brown



755 tenorite grey



890 cavansite blue



775 iridium silver



988 diamond silver



792 palladium silver

Special metallic paints

Additional-cost option



799 designo diamond white bright



996 designo hyacinth red bright



Nappa leather upholstery

Standard on AMG Line and GLE450 AMG 4MATIC



811A pearl black/black

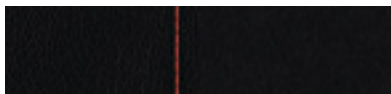

821A pearl black/black with red stitching



855A porcelain/black

designo Exclusive nappa leather upholstery

Standard on designo Line



955A porcelain/black

AMG Exclusive nappa leather upholstery

Standard on Mercedes-AMG GLE 63 S 4MATIC



541A black with grey stitching



535A porcelain/black



534A espresso brown/black

Trim



729 black poplar wood¹

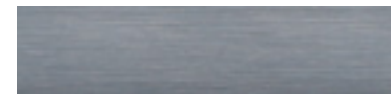

739 brushed light aluminium²



734 high-gloss brown eucalyptus wood trim^{3,4}



H09 brown open-pore ash wood trim^{3,4}



H10 AMG carbon fibre/black piano lacquer³



H21 designo black piano lacquer^{3,4}







¹Standard on designo Line ²Standard on AMG Line and Mercedes-AMG GLE 63 S 4MATIC ³Additional-cost option ⁴No-cost option on designo Line

Trim and upholstery combinations

	AMG Line			designo Line	Mercedes-AMG GLE 63 S 4MATIC		
	Nappa leather			designo Exclusive nappa leather	AMG Exclusive nappa leather		
	pearl black/black (811A)	pearl black/black with red stitching (821A)	porcelain/black (855A)	porcelain/black (955A)	espresso brown/black (534A)	porcelain/black (535A)	black with grey stitching (541A)
Dashboard							
Steering wheel	black	black	black	black	black	black	black
Upper dashboard trim	black	black	black	black	black	black	black
Lower dashboard trim	black	black	black	black	black	black	black
Seats							
Seat cushion centre section	black	black	porcelain	porcelain	espresso brown	porcelain	black
Side bolster trim	black	black	black	porcelain	espresso brown	porcelain	black
Head restraint	black	black	black	porcelain	espresso brown	porcelain	black
Seat belt	black	black	black	black	black	black	crystal grey
Topstitching	grey	red	porcelain	porcelain/black	grey	black	grey
Doors							
Door trim at beltline	black	black	black	black	black	black	black
Door centre panel	black	black	porcelain	porcelain	espresso brown	porcelain	black
Roof lining	crystal grey (black) ²	crystal grey (black) ²	porcelain (black) ²	black ¹	black	porcelain (black) ²	crystal grey (black) ²
Floor covering							
Front and rear	black	black	black	black	black	black	black
Boot	black	black	black	black	black	black	black

¹DINAMICA microfibre ²Optional

Combination options

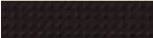
	Non-metallic paint Standard	149 polar white	Metallic paints Standard	197 obsidian black	755 tenorite grey	775 iridium silver	792 palladium silver	796 citrine brown	890 cavansite blue	988 diamond silver	Special metallic paints Additional-cost option	799 designo diamond white bright	996 designo hyacinth red bright
Nappa leather													
AMG Line (standard)													
	pearl black/black	●	●	●	●	●	●	●	○	●	●	●	●
	pearl black/black with red stitching	●		●	●	●	●	●	○	●	●	●	●
	porcelain/black	●	●	●	●	●	●	●	●	●	●	●	●
designo Exclusive nappa leather													
designo Line (standard)													
	porcelain/black	●	●	●	●	●	●	●	●	●	●	●	●
AMG Exclusive nappa leather													
Mercedes-AMG GLE 63 S 4MATIC (standard)													
	black with grey stitching	●		●	●	●	●	●	●	●	●	●	●
	porcelain/black	●		●	●	●	●	●	●	●	●	●	●
	espresso brown/black	●		●	●	●	●	△	○	●	●	△	

● Recommended ○ Possible △ Not recommended - Not available Please note that, owing to limitations of on-screen representation, paint colours may differ from those shown

Technical data

	Diesel engine	Petrol engines	
Model	GLE 350 d 4MATIC	GLE 450 AMG 4MATIC	Mercedes-AMG GLE 63 S 4MATIC

Engine				
Total displacement	cc	2,987	2,996	5,461
Arrangement/cylinders/valves		V/6/24	V/6/24	V/8/32
Power ¹	hp (kW) at rpm	258 (190)/3,400	367 (270)/5,500-6,000	585 (430)/5,500
Torque ¹	Nm at rpm	620/1,600	520/1,800-4,000	760/1,750-5,250

Transmission				
9G-TRONIC PLUS 9-speed automatic		●	●	-
AMG SPEEDSHIFT PLUS 7G-TRONIC 7-speed auto.		-	-	●

Tyre sizes				
Front		275/45	275/45	285/40
Rear		315/40	315/40	325/35

Performance				
Acceleration 0-62 mph	sec	7.0	5.7	4.2
Top speed	mph	140	155	155 ²



Model	Diesel engine		Petrol engines	
		GLE 350 d 4MATIC	GLE 450 AMG 4MATIC	Mercedes-AMG GLE 63 S 4MATIC

Weights and capacities

Kerb weight ³	kg	2,250	2,220	2,350
Perm. Gross Vehicle Weight	kg	2,900	2,880	3,050
Towing capacity – unbraked braked	kg	750 2,900	750 3,500	750 3,500
Boot capacity	l	650	650	650
Fuel tank capacity/of which reserve	l	93/12	93/12	93/14
Turning circle kerb to kerb	m	11.8	11.8	11.8
Wading depth	mm	500	500	500

Fuel consumption^{4,5}

mpg

Urban	35.8	25.0	17.9
Extra-urban ⁶	42.8	36.7	29.1
Combined	39.2	31.7	23.7

	Diesel engine	Petrol engines	
Model	GLE 350 d 4MATIC	GLE 450 AMG 4MATIC	Mercedes-AMG GLE 63 S 4MATIC

CO ₂ emissions ⁵	g/km		
Emissions standard	EU6	EU6	EU6
21" alloy wheels	187	209	-
22" alloy wheels	-	219	278

Insurance

Group rating	45-46	47-48	50
--------------	-------	-------	----

Insurance ratings may vary depending on model specification. Please refer to <http://www.thatcham.org/abigrouprating/> for further details

¹Figures according to Directive 80/1269/EEC in the currently applicable version

²Electronically limited

³Figures according to Directive 92/21/EC (kerb weight with fuel tank 90% full, driver, 68 kg, and luggage, 7 kg) for standard-specification vehicles

⁴All figures are based on a standard specification with the smallest tyre size

⁵The choice of wheels and transmission may affect CO₂ emissions and corresponding Road Fund Licence

⁶EUDC: extra-urban driving cycle. Testing procedures adhere to EU Directive 93/116

The figures on pages 54-57 are correct at time of publication. Please refer to the government website for latest data - <http://carfueldata.direct.gov.uk/>

All measurements in millimetres. The dimensions shown are mean values and apply to standard-specification, unladen vehicles



> View offers



Book a > test drive > AMG test drive



> Find a Retailer



> View the Range Guide

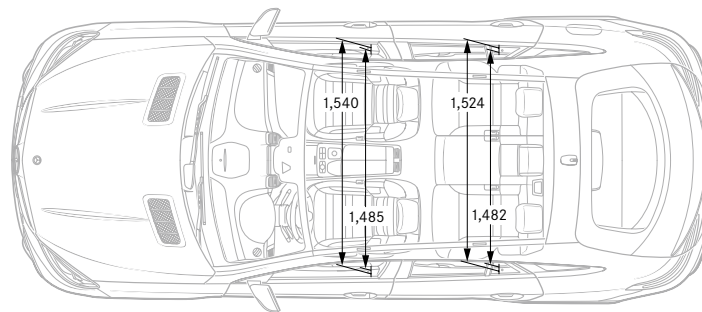
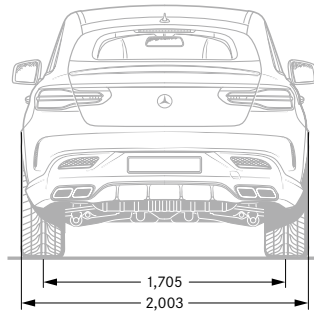
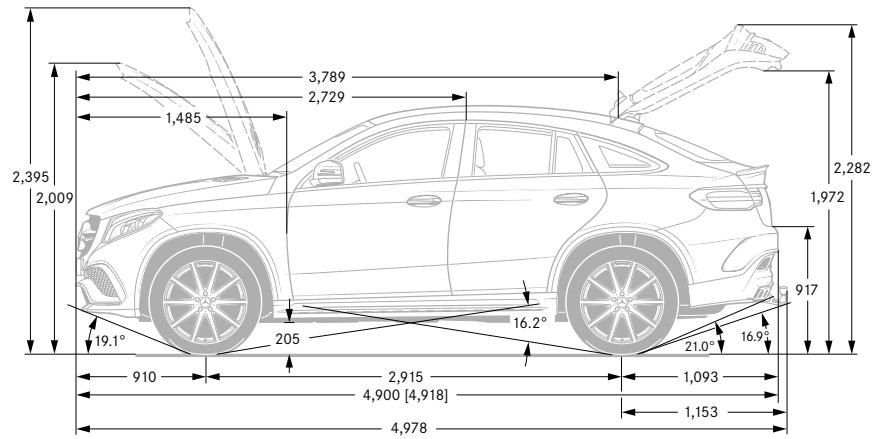
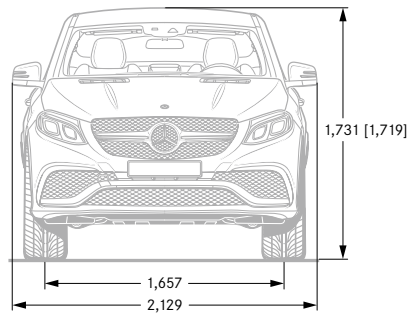

Figures in square brackets relate to Mercedes-AMG GLE 63 S 4MATIC

Road Fund Licence



All road vehicle registrations are subject to Vehicle Excise Duty (Road Fund Licence), which varies in accordance with the vehicle's CO₂ emissions. A first year rate of Vehicle Excise Duty applies to new cars on their first year of registration. For the second and subsequent years a standard rate for each taxation band will apply.¹ The table below shows the bands (A–M) created by the DVLA and the corresponding Road Fund Licence. CO₂ emissions are listed in the technical data on page 56 and the relevant Excise Duty is reflected in the on-the-road prices on page 10.

Band	CO ₂ emissions	First year rate (£)	Standard rate (£)
A	up to 100 g/km	0.00	0.00
B	101 to 110 g/km	0.00	20.00
C	111 to 120 g/km	0.00	30.00
D	121 to 130 g/km	0.00	110.00
E	131 to 140 g/km	130.00	130.00
F	141 to 150 g/km	145.00	145.00
G	151 to 165 g/km	185.00	185.00
H	166 to 175 g/km	300.00	210.00
I	176 to 185 g/km	355.00	230.00
J	186 to 200 g/km	500.00	270.00
K	201 to 225 g/km	650.00	295.00
L	226 to 255 g/km	885.00	500.00
M	over 255 g/km	1,120.00	515.00

Some of the model features, optional extras and colours shown may not be available or may only be available in a different specification.

¹ For further information on vehicle taxation please refer to <http://carfueldata.direct.gov.uk/>

Services and insurance

Mercedes-Benz Service Care

We believe that servicing costs should be as flexible and affordable as possible for your GLE Coupé, which is why we offer Service Care, an easy way to budget for all your servicing costs. It spreads your bills into manageable payments based on whether you have a new or used Mercedes-Benz.

With Service Care we guarantee the price of parts and labour for up to four services and safeguard against further inflation. It also covers the cost of all recommended service items including brake fluid, spark plugs, air filters, fuel filters and screen wash.

You can choose either to add your servicing costs into your monthly spend or pay the full amount in a one-off payment, giving you peace of mind that they are taken care of for the period of the plan.

To receive a personalised Service Care plan recommendation visit the Service Care Calculator at servicecarerates.mercedes-benz.co.uk

Warranty and breakdown cover

Every Mercedes-Benz comes with a three-year unlimited mileage warranty against manufacturing or material defects¹ and up to 30 years warranty against perforation due to corrosion from the inside out². What's more, it's also covered by Mercedes-Benz Roadside Assistance – a unique package comprising up to 30 years pan-European breakdown assistance.²

Insurance

Since our name is synonymous with reliability, who better to trust with your motor insurance? Mercedes-Benz Insurance provides a motor insurance policy specifically designed to give you the cover you would expect from Mercedes-Benz. For a motor insurance quotation, call **0345 600 2180**.*

The Mercedes that thinks and acts for you.

Imagine if...

...you could connect with your Mercedes-Benz?

With Mercedes me connect, you can; with Remote Online services¹ that include trip planning, maintenance management and vehicle tracking, plus more.

Getting connected is easy. Just set up your Mercedes me account and get in touch with your Mercedes-Benz Retailer to connect your vehicle to your profile to access your Mercedes me connect services.

...you knew beforehand that you need to stop for fuel?

Simply check the fuel level and mileage range from your phone wherever you are. You can also check tyre pressure and washer fluid level. (For electric cars, you can check battery charge state.)

...your Mercedes could tell you where it's parked?

You no longer need to ask yourself where you left your car; with Mercedes me connect you can locate your car from your smartphone or tablet within a mile radius.



1. PARKED VEHICLE LOCATOR
2. VEHICLE TRACKER

3. REMOTE RETRIEVAL OF VEHICLE STATUS
4. PRE-ENTRY CLIMATE CONTROL FOR ELECTRIC DRIVE AND PLUG-IN HYBRID



> View offers



Book a > test drive > AMG test drive



> Find a Retailer



> View the Range Guide

...you could lock your Mercedes, even if you're miles away?

The uncertainty of whether you've forgotten to lock the car is only human. To make sure your Mercedes-Benz is safe and secure, you can simply lock the car remotely via your PC/Mac, tablet or smartphone.

...your Mercedes told you when your service is due?

Being connected means essential data is constantly sent to your Mercedes-Benz Retailer so they know when it is time for a service. Your Retailer can then contact you with a tailor-made service quote.

...your Retailer already knows which parts need replacing?

As surprising as this sounds, with tediagnosics your Retailer can recognise remotely if certain parts are due for replacement, contacting you to book an appointment and making sure the relevant parts are in stock when you arrive, getting you back on the road as quickly as possible.

...you could just push a button to deal with a breakdown?

Should your car break down, with a simple press of the button everything is taken care of – from breakdown assistance to vehicle recovery.

...your Mercedes called for help?

Your Mercedes comes with an SOS button. Press it if you need urgent help and you will be contacted by the emergency response centre.² In the event of an accident where airbags or seatbelt tensioners have been activated, a call is placed automatically. Your GPS position is sent to the response teams to initiate rescue efforts.³

The Mercedes that thinks and acts for you.

Contact your Retailer to get connected, or go to www.mercedes.me for more details.

¹This is available as an option in conjunction with Audio 20 CD, and standard with COMAND Online. Remote Online is standard with electric drive and plug-in hybrid. Use of the Remote Online equipment option is limited to three years from first registration of the vehicle and can then be extended at extra cost.

²A call is placed via the car's sim card, rather than the customer relying on their mobile phone.

³This feature is still available to customers without Mercedes me connect services. The customer is not required to accept the terms and conditions on the portal to activate this feature. For all other features the customer will have to accept terms and conditions on the portal to activate them.



Mercedes-Benz Finance

Why should you finance with Mercedes-Benz?

At Mercedes-Benz we believe a great driving experience should be matched by an equally great ownership experience. That is why we put just as much thought, time and effort into designing our finance options, our service plans and our insurance cover as we do into our vehicles.

We are not in the business of simply providing a loan to fund the purchase of your dream vehicle. We look on it as a journey that we take with you, from the moment you choose your new Mercedes-Benz, to helping you in choosing your next one.

If you would like to find out more about any of our current offers, simply call into your local Mercedes-Benz Retailer where one of our Business Managers will be more than happy to talk you through anything you need to know.

Helping you find the right solution.

You should find our finance packages are more convenient than a traditional personal loan because:

- Funds are immediately available – no waiting for cheques or loans to clear.
- There is no security required – either against your home or other assets.
- We have clear and transparent rates – the APR we quote is the APR you get.
- We have friendly Business Managers – experts in vehicle finance who can talk you through all of your plans in detail.

One of our most popular finance products is Mercedes-Benz Agility (our Personal Contract Purchase product). We also offer Contract Hire, Operating Lease and Hire Purchase solutions. If you would like to find out more about these speak to your Retailer or visit www.mercedes-benz.co.uk/fandi.

Mercedes-Benz Agility (our PCP product).

At the start of an Agility agreement, you put down a deposit and decide the term of your agreement and your annual mileage. You will be advised of the Guaranteed Future Value, which offers you the reassurance of knowing exactly what you will need to pay to own the vehicle outright in the future (this is known as the Optional Purchase Payment).

Throughout your agreement you simply pay your agreed monthly payments and when the agreement comes to an end you either purchase, hand back or part-exchange your vehicle.



Agility features:

- Fixed regular payments mean you can easily budget.
- Payments are based only on a proportion of the vehicle's value, keeping your monthly payments lower.
- Our Guaranteed Future Value avoids the risk of unplanned depreciation of your vehicle.
- You defer your ownership decision until the end of the agreement.

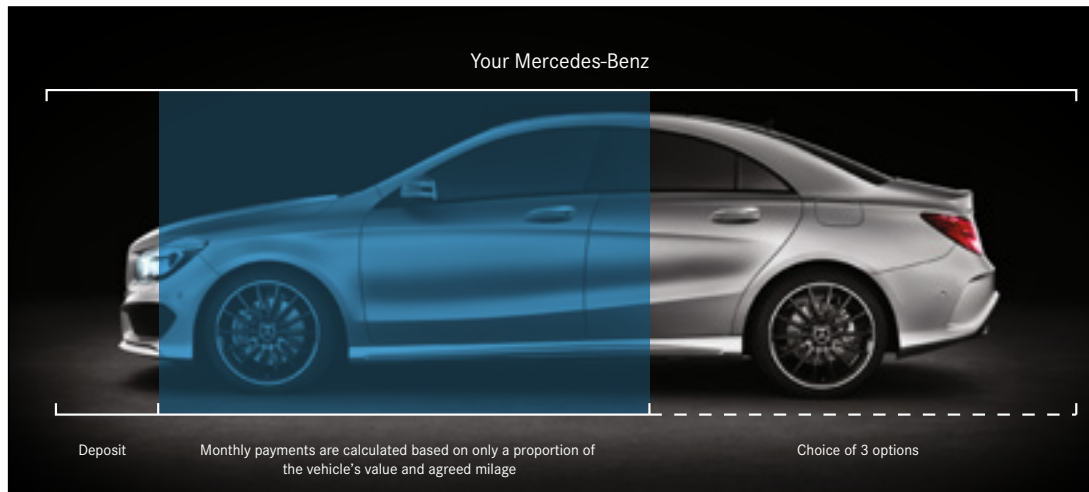

At the end of your agreement you have three options to choose from.

Option 1: Purchase your Mercedes-Benz.

Purchase your Mercedes-Benz by paying the Optional Purchase Payment and Purchase Activation Fee.¹ This will complete the purchase of your Mercedes-Benz, leaving you free to simply enjoy your vehicle.

Option 2: Hand back your Mercedes-Benz.

If you decide to return your vehicle to us, it must be in line with our Vehicle Return Standards,* as vehicle condition, excess mileage and other charges may be payable.

Option 3: Part-Exchange for a new vehicle.

Purchase your Mercedes-Benz by paying the Optional Purchase Payment and Purchase Activation Fee.¹ This will complete the purchase of your Mercedes-Benz, leaving you free to part-exchange for a new vehicle.

¹Please note the 'Purchase Activation Fee' of £10 will be debited from your account *To find out more information about our Vehicle Return Standards please visit <http://mercedes-benz.co.uk/vrs>

 > View offers

 Book a > test drive > AMG test drive

 > Find a Retailer

 > View the Range Guide

Follow us on the following social media channels:

 <https://www.facebook.com/MercedesBenzUk>

 <https://twitter.com/mercedesbenzUK>

 <https://www.youtube.com/mercedesbenzUK>

 <https://instagram.com/mercedesbenzUK>

Effective from 1 April 2016. Information correct at time of publication.

Prices and specifications are subject to change without prior notice.

MBC292PL/0416 MY 806.5 Production from 01.01.2016

Mercedes-Benz UK Ltd, Tongwell, Milton Keynes, MK15 8BA www.mercedes-benz.co.uk