



> View offers



Book a

- > test drive
- > AMG test drive



> Find a Retailer



> View the Range Guide

G-Class



Effective from 1 September 2017 Production.

Mercedes-Benz



Contents

Model prices	17	Night package	41	Technical data	54
Finance offers	18	Driving Assistance package	42	Road Fund Licence	59
Model lines	22	Entertainment package	43	Services and insurance	60
Mercedes-AMG driver training	30	Winter package	44	Mercedes me	61
Standard equipment	32	Pricing summary for packages	45	Mercedes-Benz Finance	62
Wheels	37	Optional equipment	46		
Sports Styling package	40	Colours and materials	51		

The hard facts to melt your heart

At Mercedes-Benz we appreciate the importance of detail. Over the following pages you'll find model prices and a breakdown of standard and optional equipment, as well as details of the comprehensive services and benefits that are available to every Mercedes-Benz driver.

See Mercedes-Benz in a new light. Now is the time to get yourself behind the wheel of an G-Class. Choose from a number of attractive finance offers. Please see pages 18-21 for further details, or visit www.mercedes-benz.co.uk/offers

Of course, some things have to be experienced to be truly appreciated, such as the qualities that set a Mercedes-Benz apart. Which is why we'd like to invite you for a test drive at your local Mercedes-Benz Retailer. Alternatively, you can make arrangements by visiting www.mercedes-benz.co.uk/testdrive

For more information visit www.mercedes-benz.co.uk or call 0333 222 0500.



> View offers



Book a
> test drive
> AMG test drive



> Find a Retailer



> View the Range Guide



Model features optional equipment at an additional cost.



> View offers



Book a
> test drive
> AMG test drive



> Find a Retailer



> View the Range Guide



Model features optional equipment at an additional cost.



> View offers



Book a
> test drive
> AMG test drive



> Find a Retailer



> View the Range Guide





> View offers



Book a

- > test drive
- > AMG test drive



> Find a Retailer



> View the Range Guide



Model features optional equipment at an additional cost.



> View offers



Book a

- > test drive
- > AMG test drive



> Find a Retailer



> View the Range Guide



Model features optional equipment at an additional cost.



> View offers



Book a

- > test drive
- > AMG test drive



> Find a Retailer



> View the Range Guide





> View offers



Book a
> test drive
> AMG test drive



> Find a Retailer



> View the Range Guide





> View offers



Book a
> test drive
> AMG test drive



> Find a Retailer



> View the Range Guide





> View offers



Book a

- > test drive
- > AMG test drive



> Find a Retailer



> View the Range Guide

We are G-Class.

A claim that visitors to the production facility in Graz will hear often. The G-Class has been hand-built here for the last 35 years – filling everyone involved with pride. The variety of models necessitates to this day a manual process on just one production line. From a range of more than 10,000 individual parts, experienced technicians therefore select the 3000 or so that they need, which they then assemble with exemplary care to create a new G-Class. Only after more than 100 man-hours of work – almost three times as much as for a machine-produced vehicle – will a G-Class leave its place of origin.



> View offers



Book a > test drive
> AMG test drive



> Find a Retailer



> View the Range Guide



13

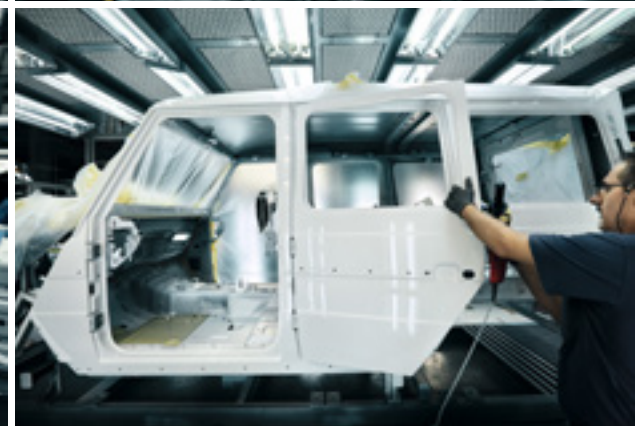



> View offers



Book a

- > test drive
- > AMG test drive



> Find a Retailer



> View the Range Guide

Boulders protruding half a metre out of the track. Massive tree roots breaking through the surface. The sort of terrain that would defeat any other vehicle. Welcome to the 'Schöckl' mountain. During the ongoing process of development, a G-Class must survive several thousand kilometres or more on the company's own test track. Only once the axles, frame, bodyshell, drive train and major assemblies are proven to hold out longer than their drivers, will we certify them as 'Schöckl-proof and ready for series production'.

Tried, tested and Schöckl-proof.





> View offers



Book a

- > test drive
- > AMG test drive



> Find a Retailer



> View the Range Guide





> View offers



Book a > test drive
> AMG test drive



> Find a Retailer



> View the Range Guide



Model features optional equipment at an additional cost.

Model prices

Engine	Model line	Transmission	CO ₂	Basic RRP excl. VAT (£)	Total RRP incl. VAT (£)	Road Fund Licence (£) ¹	Rec. OTR price (£) ²	P11D value (£)	BiK tax rate 2017/18 (%)
G 350 d Diesel – 2,987 cc, 6-cylinder, 245 hp/180 kW	–	7G-TRONIC PLUS 7-speed automatic	261	74,462.50	89,355.00	2,000.00	92,070.00	90,015.00	37
Mercedes-AMG									
Mercedes-AMG G 63 Petrol – 5,461 cc, 8-cylinder, 571 hp/420 kW	–	AMG SPEEDSHIFT PLUS 7-speed auto.	322	111,029.17	133,235.00	2,000.00	135,950.00	133,895.00	37
Mercedes-AMG Colour Edition									
Mercedes-AMG G 63 Petrol – 5,461 cc, 8-cylinder, 571 hp/420 kW	–	AMG SPEEDSHIFT PLUS 7-speed auto.	322	124,904.17	149,885.00	2,000.00	152,600.00	150,545.00	37
Mercedes-AMG EDITION 463									
Mercedes-AMG G 63 Petrol – 5,461 cc, 8-cylinder, 571 hp/420 kW	–	AMG SPEEDSHIFT PLUS 7-speed auto.	322	126,275.00	151,530.00	2,000.00	154,245.00	152,190.00	37

¹A different first year rate of Vehicle Excise Duty (Road Fund Licence) applies for new cars. Please refer to page 59 for the relevant rate for the second and subsequent years

²The recommended on-the-road price includes the Road Fund Licence applicable to the standard model plus delivery charge (£635.00 incl. VAT), new vehicle registration fee (£55.00) and number plates (£25.00 incl. VAT). VAT is calculated at the standard rate of 20%

Mercedes-Benz Finance

It comes with a specification list worth exploring



G 350 d (representative example)

Based on 10,000 miles per annum

24 monthly payments of ¹	£999.00
Customer deposit	£17,999.00
On-the-road price	£92,025.00
Retailer deposit contribution	£8,648.79
Optional purchase payment ²	£47,750.00
Amount of credit	£65,377.21
Duration of agreement	24 months
Total amount payable ³	£98,383.79
Purchase activation fee ²	£10.00
APR	5.7%
Fixed interest rate	5.56%
Excess mileage	30p per mile

**Example offer –
5.7% APR Representative**

	Automatic	Metallic	On-the-road price	Retailer deposit contribution	Customer deposit	24 monthly payments of ¹
G350d	●	●	£92,025.00	£8,648.79	£17,999.00	£999.00

- Standard equipment

Mercedes-Benz Service Care

- Mercedes-Benz trained Technicians
- Maintained by Mercedes-Benz Retailers
- Meets requirements of Mercedes-Benz Agility finance agreement

Mercedes-Benz Motor Insurance

- 24/7 UK accident recovery
- We use Mercedes-Benz GenuineParts
- To qualify for up to 10% discount online, go to www.mercedes-benz.co.uk/motorinsurance
- Alternatively, call Mercedes-Benz Motor Insurance now on **0345 600 2180⁴** for an annual quote

We may decline to quote in some circumstances. Mercedes-Benz Motor Insurance is underwritten by Aviva Insurance Limited

Content relating to finance is promoted by Mercedes-Benz Finance. Your Retailer may offer finance on behalf of other companies.

Orders/credit approvals on selected G-Class models only, between 1 April and 30 June 2017, registered by 30 September 2017; excluding Mercedes-AMG models. Some combinations of features/options may not be available.

Please contact your local Mercedes-Benz Retailer for availability

¹Based on a Mercedes-Benz Agility agreement. Vehicle condition, excess mileage and other charges may be payable. Quotations available on request for alternative contract lengths and mileages.

Guarantees may be required. Credit provided, subject to status, by Mercedes-Benz Finance, MK15 8BA

²Payable if you exercise the option to purchase the car

³Includes optional purchase payment, purchase activation fee and Retailer deposit contribution (where applicable)

⁴Calls are charged at local rate and may be recorded



> View offers



Book a

- > test drive
- > AMG test drive



> Find a Retailer



> View the Range Guide

Mercedes-Benz Finance

Even the finance offer is beautifully put together



Mercedes-AMG G 63 (representative example)

Based on 10,000 miles per annum

36 monthly payments of ¹	£1,799.00
Customer deposit	£19,049.00
On-the-road price	£135,905.00
Retailer deposit contribution	£8,196.20
Optional purchase payment ²	£54,825.00
Amount of credit	£105,499.80
Duration of agreement	36 months
Total amount payable ³	£145,903.28
Purchase activation fee ²	£10.00
APR	5.7%
Fixed interest rate	5.56%
Excess mileage	43.2p per mile

**Example offer –
5.7% APR Representative**

	Automatic	Metallic	On-the-road price	Retailer deposit contribution	Customer deposit	36 monthly payments of ¹
Mercedes-AMG G 63	●	●	£135,905.00	£8,196.20	£19,049.00	£1,799.00

- Standard equipment

Mercedes-Benz Service Care

- Mercedes-Benz trained Technicians
- Maintained by Mercedes-Benz Retailers
- Meets requirements of Mercedes-Benz Agility finance agreement

Mercedes-Benz Motor Insurance

- 24/7 UK accident recovery
- We use Mercedes-Benz GenuineParts
- To qualify for up to 10% discount go online, to www.mercedes-benz.co.uk/motorinsurance
- Alternatively, call Mercedes-Benz Motor Insurance now on **0345 600 2180⁴** for an annual quote

We may decline to quote in some circumstances. Mercedes-Benz Motor Insurance is underwritten by Aviva Insurance Limited

Content relating to finance is promoted by Mercedes-Benz Finance. Your Retailer may offer finance on behalf of other companies.

Orders/credit approvals on Mercedes-AMG G 63 models only, between 1 April and 30 June 2017, registered by 30 September 2017; excluding non-Mercedes-AMG models. Some combinations of features/options may not be available. Please contact your local Mercedes-Benz Retailer for availability

¹Based on a Mercedes-Benz Agility agreement. Vehicle condition, excess mileage and other charges may be payable. Quotations available on request for alternative contract lengths and mileages.

Guarantees may be required. Credit provided, subject to status, by Mercedes-Benz Finance, MK15 8BA

²Payable if you exercise the option to purchase the car

³Includes optional purchase payment, purchase activation fee and Retailer deposit contribution (where applicable)

⁴Calls are charged at local rate and may be recorded



> View offers



Book a
> test drive
> AMG test drive



> Find a Retailer



> View the Range Guide

G 350 d



Now in its fourth decade, the G-Class boasts the same classic lines that have always made it such a unique presence. Its large glass area features distinctively shaped load compartment windows; the side skirts, shoulder lines, roof lines and side rubbing strips are almost exactly parallel, and the high wheel arches and wide track, together with a rear that's slightly thicker at the base, add up to a sturdy looking body with optimum off-road ability.

Inside, the spacious G-Class cabin is supremely comfortable whatever the distance or weather, thanks to a 2,850 mm wheelbase, heat-insulating glass all round, and heated seats front and rear. The G-Class accommodates equipment with ease too, offering up to 2,250 litres of luggage capacity and easy access via the large side-hinged tailgate. The standard 1/3:2/3 split folding rear seat and load-securing points further enhance its versatility.

Exterior

18" alloy wheels – 5-twin-spoke design, painted silver, 265/60 tyres

Bi-xenon headlamps and LED daytime running lamps

Exterior mirrors – electrically adjustable, heated and painted in vehicle colour

Metallic paint

Parking-assistance PARKTRONIC

Privacy glass

Rain-sensing wipers

Reversing camera

Tow bar

Interior

Ambient lighting

COMAND Online system with Media Interface and 8-inch colour display

DAB digital radio tuner

Front and rear seats – heated

Instrument cluster with colour display

Leather upholstery in black, alpaca grey or chestnut

Smartphone integration (Apple CarPlay™ and Android Auto)

Surround sound system – Harman Kardon® Logic 7® with 12 high-performance speakers

Twin bottle holder in rear

Trim and Upholstery

Anthracite poplar wood



Leather – black



Leather – alpaca grey



Leather – chestnut





> View offers



Book a

- > test drive
- > AMG test drive



> Find a Retailer



> View the Range Guide

Mercedes-AMG G 63



With 571 hp (420 kW) from its AMG biturbo V8, 760 Nm of torque and fuel-saving features such as ECO start/stop, the Mercedes-AMG G 63 is a remarkable combination of exhilaration and efficiency. Visually, it's simply unmistakable, thanks to the AMG two-bar grille with chrome trim, AMG wheel arch extensions, 'V8 BITURBO' badges on the front wings and an AMG exhaust system with side-exiting twin chromed tailpipes. Also fitted as standard are the Exterior Styling package, 20" AMG 5-twin-spoke alloy wheels with

titanium grey finish and large 275/50 tyres with red-painted brake calipers. The cabin is similarly special, with illuminated AMG stainless steel door sill panels, designo leather upholstery, leather trim for the dashboard and AMG performance multi-function steering wheel, door panels in ruffled leather, ambient interior lighting, chrome trim and a designo black DINAMICA microfibre roof lining. There's also a choice of three designo wood trims and the option of AMG carbon-fibre trim for an even more dynamic look.

Exterior

20" AMG alloy wheels – 5-twin-spoke design, titanium grey high-sheen finish, 275/50 tyres

AMG door sill panels in polished stainless steel

AMG logo in front grille

AMG radiator grille featuring twin chromed louvres with central Mercedes-Benz star

AMG red brake calipers

AMG sports exhaust system with chrome-trimmed twin tailpipes

Chrome package and Exterior Styling package

Electric steel sunroof – tilting/sliding, with one-touch opening

Metallic paint

Privacy glass

Interior

AMG instrument cluster with colour display (TFT technology)

COMAND Online system with Media Interface

DAB digital radio tuner

Multifunction AMG performance steering wheel trimmed in black nappa leather

Single-tone designo leather in a choice of eight colours

Surround sound system – Harman Kardon® Logic 7® with 12 high-performance speakers

THERMATIC – automatic climate control

Twin bottle holder in rear

Trim and Upholstery

designo black piano lacquer

designo leather – black

Mercedes-AMG G 63 Colour Edition



Mercedes-AMG G 63 Colour Edition – solar beam with obsidian black exterior trim highlights and optional wheels (code R11)



Interior contrast stitching matching the exterior paint colour



AMG carbon fibre trim

What could be more striking than the Mercedes-AMG G 63? Perhaps a version of the same with an injection of strong, vivid colour? The new Mercedes-AMG G 63 Colour Edition offers five new exterior paints – tomato red, alien green, galactic beam, solar beam and sunset beam – all with complimentary sports styling details inside and out. Obsidian black accents feature on the trim, mirrors, roof, bumpers, fender flares and spare wheel

cover. The vibrant contrast continues in the interior with matching body colour contrast stitching on key elements including seats, dashboard, centre console and door panel. All models come as standard with AMG carbon fibre trim and black designo nappa leather upholstery regardless of which exterior colour is chosen. The result is a truly outstanding, highly energising look for a Mercedes-AMG G 63 like no other.



Mercedes-AMG G 63 Colour Edition – in a choice of five colours

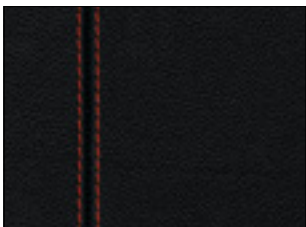

Tomato red (code 150)

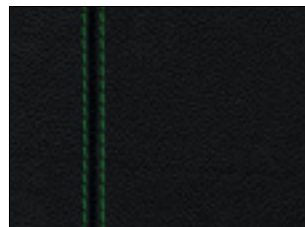

Alien green (code 166)

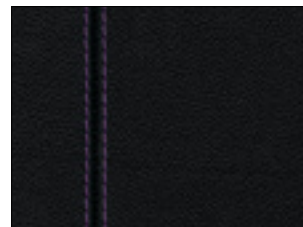

Galactic beam (code 171)

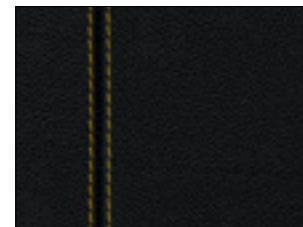

Solar beam (code 278)

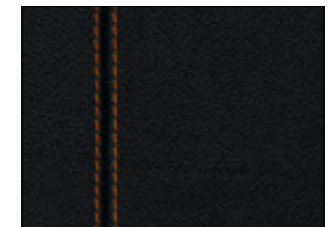

Sunset beam (code 173)



> View offers



Book a

- > test drive
- > AMG test drive



> Find a Retailer



> View the Range Guide

Mercedes-AMG EDITION 463



Protective grilles for headlamps not shown



Two-tone seats in high-quality designo leather



Protective grilles for headlamps



21" black alloy wheels (R12)

With the new EDITION 463 special model, Mercedes-AMG is giving the G-Class an impressive sporty look. The exquisite interior specification includes a two-tone instrument panel, two-tone seats in high-quality designo leather with side bolsters in carbon-look leather and contrasting topstitching, seat and door centre panels in a diamond design, carbon-fibre trim and door handles in nappa leather.

On the outside, a stainless steel guard under the engine, AMG sport stripes along the sides, a protective-strip insert in black aluminium-look as well as exclusive 21" forged wheels underscore both the dynamics and exclusivity of the special model. The EDITION 463 special model is based on the Mercedes-AMG G 63.

Exterior

21" alloy wheels – 5-twin-spoke design, matt black finish, 275/50 tyres

AMG sports stripes along sides

Metallic paint

Stainless steel guard under engine

Protective grilles for headlamps

Winter package, including auxiliary heater and heated windscreen

Interior

designo Exclusive package – without embossed crests in the head restraints

Driving Assistance package, including Blind Spot Assist and Distance Pilot DISTRONIC

Entertainment package, including rear seat entertainment system and TV tuner

Two-tone seats in high-quality designo leather

Seat and door centre sections with diamond-pattern design in designo colour

Trim and Upholstery

AMG carbon fibre



designo leather – black



designo leather – light brown



designo leather – porcelain



Exclusive driver training for Mercedes-AMG G 63 owners

All Mercedes-AMG G 63 customers are invited to a complimentary AMG Driving Academy Training experience at Mercedes-Benz World.



With friendly one-to-one tuition from a professional Mercedes-AMG driver, your training will be personalised to you. You'll push Mercedes-AMG driving performance and your driving skills to the limits on our track and purpose-built low friction dynamic handling facilities.

Through high-speed and adrenaline-fuelled exercises you'll experience oversteer, understeer, slaloms and many more performance driving skills. Designed as part of your ownership experience, this will lay the foundations to master a high-performance vehicle, develop driving skills with maximum enjoyment and prepare you to take full command of your own Mercedes-AMG.

TERMS AND CONDITIONS

The following only are eligible: the first purchaser/registered keeper of a newly-registered Mercedes-AMG G 63; the second owner/registered keeper of a Mercedes-AMG purchased from a Mercedes-Benz Retailer, where the vehicle is less than 90 days from registration. The AMG Driving Academy Training experience is the AMG BASIC-Training as detailed in the further information above and must be booked and taken within six months of delivery of your Mercedes-AMG G 63; it cannot be exchanged and cannot be transferred for any other driving experience. The Training experience is available Monday to Friday only and is subject to availability. Mercedes-Benz UK Limited reserves the right to amend or withdraw this Training experience. Attendees must hold a full UK driving licence. Attendees will be required to sign the Mercedes-Benz World Driving Risk Acknowledgement prior to undertaking the Training experience. The Training experience is also subject to the Mercedes-Benz World Terms and Conditions, as applicable.



> View offers



Book a

- > test drive
- > AMG test drive



> Find a Retailer



> View the Range Guide



Standard equipment



Colour display in instrument panel



Sequentially lockable differentials



Parking-assistance PARKTRONIC

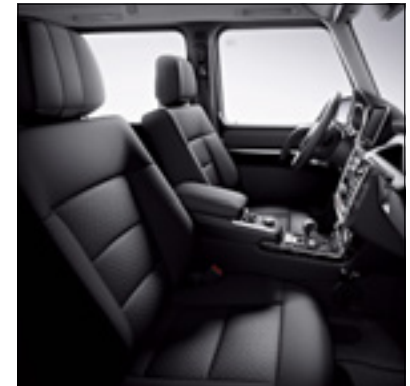

Front seats – electrically adjustable



THERMATIC – automatic climate control



Harman Kardon® Logic 7® surround sound system

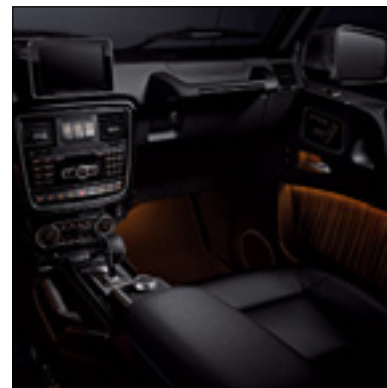

Ambient interior lighting



Bi-xenon headlamps/LED daytime running lamps

Item	G 350 d	Mercedes-AMG G 63
Transmission and Suspension		
7G-TRONIC PLUS 7-speed transmission with cruise control and variable speed limiter	●	-
AMG SPEEDSHIFT PLUS 7G-TRONIC 7-speed automatic transmission with SPEEDTRONIC cruise control	-	●
ECO start/stop function	●	●
Permanent four-wheel drive with differentials Complimentary differential oil change required after first 1,800 miles for AMG G 63 only	●	●
Exterior		
Chrome package Chrome trim for gearshift lever frame Luggage compartment door sill panel in chrome with 'AMG' lettering ('Mercedes-Benz' lettering for G 350 d) Radiator grille with chrome highlights Switch for seat adjustment and speaker grille surround in front doors	△	●
Exterior Styling package Running boards left and right Spare wheel cover in stainless steel with three-dimensional Mercedes-Benz star	△	●
AMG bodystyling with exclusive G 63 AMG front aprons with cooling air intakes in black and AMG flared wheel arches in vehicle colour	-	●
AMG brake calipers, painted red	-	●

Item	G 350 d	Mercedes-AMG G 63
AMG brake calipers, painted silver – only in conjunction with galactic beam (code 171) and tomato red (code 150)	-	●
AMG door sill panels in brushed stainless steel	-	●
AMG radiator grille with chrome-trimmed twin louvre, chrome-trimmed grid and AMG logo	-	●
AMG sports exhaust system with two chrome-trimmed twin tailpipes, left and right	-	●
Bumpers – painted in body colour, front and rear	●	●
Differential locks (transfer case, front and rear axle)	●	●
Door mirrors – electrically adjustable and heated Integrated indicators, front area lighting and automatically dimming driver's mirror	●	●
Electric steel sunroof – tilting/sliding, with one-touch opening	○	●
Front fog lamps with integral cornering light function	●	-
Headlamps – bi-xenon, with automatic range adjustment and cleaning system	●	●
LED daytime running lamps	●	●
Low range gear reduction (electronically selectable while driving)	●	●
Obsidian black exterior trim highlights (mirrors, roof, front and rear bumpers, fender flares and spare wheel cover) only in conjunction with the Colour Edition	-	●
Parking-assistance PARKTRONIC	●	●



> View offers



Book a

- > test drive
- > AMG test drive



> Find a Retailer



> View the Range Guide

Standard equipment

34

Item	G 350 d	Mercedes-AMG G 63
Exterior (continued)		
Privacy glass – dark glass from B-pillar backwards	●	●
Radiator grille with three-louvre design	●	–
Rain-sensing wipers	●	●
Rear lamps – LED-look	●	●
Reversing camera	●	●
Spare wheel cover in black plastic	●	–
Tow bar	●	●

Item	G 350 d	Mercedes-AMG G 63
Interior		
12 V sockets in front passenger footwell, rear and load compartment	●	●
AMG instrument cluster with colour display (TFT technology)	–	●
Ambient lighting	●	●
Automatically dimming rear-view mirror	●	●
Centre armrest between front seats with integrated stowage compartment	●	●
Cup holder – front passenger, with twin bottle holder in rear	●	●
Dashboard – leather-covered	●	●
Electric windows (4)	●	●
Front seats – heated and electrically adjustable Memory function for seats, head restraints, exterior mirrors and steering wheel	●	●
Instrument cluster with colour display (TFT technology)	●	–
Interior contrast stitching matching the exterior paint colour (seats, dashboard, centre console, handbrake, upper door panel edge and grab handle) only in conjunction with the Colour Edition	–	●
Luggage compartment cover	●	●
Luggage protection net	●	●
Rear bench seat – split folding 1/3:2/3	●	●



> View offers



Book a

- > test drive
- > AMG test drive



> Find a Retailer



> View the Range Guide



Item	Mercedes-AMG G 63	
	G 350 d	
Interior (continued)		
Rear seats – heated	●	●
Seat belts, 3-point design (4)	●	●
Seat belt pre-tensioners (4)	●	●
Seat Comfort package Vented multi-contour front seats	△	●
THERMATIC – automatic climate control	●	●
Steering		
Multifunction AMG performance steering wheel and AMG gearshift lever trimmed in nappa leather	-	●
Multifunction steering wheel and gearshift lever in nappa leather	●	-
Steering column – electrically adjustable, with automatic adjustment for entry/exit	●	●



Item	Mercedes-AMG G 63	
	G 350 d	
Paint, Trim and Upholstery		
Paint – metallic	●	●
Roof lining – designo black DINAMICA microfibre	-	●
Roof lining – grey	●	-
Trim – anthracite poplar wood	●	-
Trim – designo black piano lacquer	○	●
Upholstery – leather	●	-
Upholstery – designo leather	○	●

Item	G 350 d	Mercedes-AMG G 63
Safety and Assistance Systems		
AMG high-performance braking system	-	●
Airbags – driver and front passenger	●	●
Airbags – front side	●	●
Airbags – windowbags	●	●
Anti-lock braking system (ABS) with Brake Assist (BAS)	●	●
Anti-theft alarm system with tow-away protection and interior motion sensor	●	●
Electronic Brake Force Distribution (EBD)	●	●
Electronic Stability Programme (ESP®) with Acceleration Skid Control (ASR)	●	●
Four-wheel Electronic Traction System (4ETS)	●	●
Headlamp Assist – automatic headlamp activation	●	●
ISOFIX child seat fixing points in rear (two outer seats)	●	●
Service indicator ASSYST	●	●
Tyre pressure monitoring system	●	●

Item	G 350 d	Mercedes-AMG G 63
Communications and In-Car Entertainment		
Bluetooth® interface for hands-free telephony	●	●
Central controller dial to operate audio functions and telephone (when connected)	●	●
COMAND Online system with Media Interface Includes radio, single CD, 8-inch colour display, hard disk drive (HDD) navigation with 3D map display, Live Traffic Information and European map data updates free of charge for the first three years. Speed Limit Assist, single CD/DVD and LINGUATRONIC voice control in centre console. Bluetooth® interface with hands-free system and audio streaming for SMS, E-Mail, Writing and Reading function and Bluetooth® audio streaming for music transfer, radio with twin tuner. Mercedes me connect services, emergency call system (eCall) and access to internet sites when the vehicle is stationary, plus unrestricted use of Mercedes-Benz apps (internet-enabled mobile phone required). Integrated WLAN hotspot for onboard access of WLAN-enabled devices. DVD function is audio and video capable (region 2 DVDs only)	●	●
DAB digital radio tuner	●	●
Smartphone integration comprising Apple CarPlay™ and Android Auto See www.apple.com/uk/ios/carplay/ or www.android.com/intl/en_uk/auto for compatibility and approved apps. Certain features and apps require a 3G/4G data connection. Control of features available through voice control and controller on centre console	●	●
Surround sound system – Harman Kardon® Logic 7® with Dolby Digital 5.1 and DTS 12 high-performance speakers and additional amplifier	●	●
Two USB ports in centre armrest and an SD card slot in centre console	●	●

A revolution in style

Item	Notes			G 350 d	Mercedes-AMG G 63	Basic RRP excl. VAT (£)	Total RRP incl. VAT (£)
Wheels							
18" alloy wheels (4) – 5-twin-spoke design, painted silver 265/60 tyres			RM9	●	-	-	-
18" alloy wheels (4) – 5-twin-spoke design, painted black 265/60 tyres	Included with Night package (code NP1). Not available in conjunction with Sports Styling package (code DP8)		R11	△	-	Included in Night package	
19" AMG alloy wheels (4) – 5-twin-spoke design, painted matt black 275/55 tyres	Included with Sports Styling package (code DP8). Please refer to page 40 for more information		RK5	△	-	Included in Sports Styling package	

Item	Notes			G 350 d	Mercedes-AMG G 63	Basic RRP excl. VAT (£)	Total RRP incl. VAT (£)
Wheels (continued)							
20" AMG alloy wheels (4) – 5-twin-spoke design, burnished titanium grey high-sheen finish 275/50 tyres			R10	-	●	-	-
20" AMG alloy wheels (4) – 5-spoke design, painted matt black, high-sheen finish 275/50 tyres	Silver brake calipers available with galactic beam (code 171) and tomato red (code 150)		R11	-	○	829.17	995.00
20" AMG alloy wheels (4) – 5-spoke design, painted matt black (including rim flange), high-sheen finish 275/50 tyres	Included with Night package (code NP1)		R13	-	△	Included in Night package	



> View offers



Book a



- > test drive
- > AMG test drive



> Find a Retailer



> View the Range Guide

Item	Notes		R12	-	△	G 350 d	Mercedes-AMG G 63	Basic RRP excl. VAT (£)	Total RRP incl. VAT (£)
Wheels (continued)									
21" alloy wheels (4)- 5-twin-spoke design, painted matt black 295/40 tyres	Available exclusively on Mercedes-AMG G 63 EDITION 463							-	-
21" bicolour alloy wheels (4)- 5-twin-spoke design, painted matt black 295/40 tyres	Available exclusively on Mercedes-AMG G 63 EDITION 463							-	-

Sports Styling package



Running boards left and right



Radiator grille with chrome inserts



Stainless steel spare wheel cover with 3D star



19" AMG 5-twin-spoke alloy wheels painted matt black

The Sports Styling package contains eye-catching design features for both the exterior and interior.

Sports Styling package – designed and priced as a package, including items as listed below.

G 350 d

Total incl. VAT £2,995.00

Sports Styling package (code DP8)

19" AMG 5-twin-spoke alloy wheels painted matt black (code RK5)

Additional chrome trim elements around wooden fascia for seat adjustment, around the front door loudspeaker grilles and gearshift lever frame

Black velour floor mats

Chrome load sill protector with 'Mercedes-Benz' lettering

Radiator grille with chrome inserts

Running boards left and right

Spare wheel cover in stainless steel with three-dimensional Mercedes-Benz star

Night package



The Night package offers black-painted alloy wheels, exterior mirror housings, front and rear bumpers, flared wheel arches and roof in obsidian black, plus outer protective strip inserts in black.¹

Night package – designed and priced as a package, including items as listed below.

G 350 d

Total incl. VAT £2,095.00

Mercedes-AMG G 63

£2,595.00

Night package (code NP1)

18" 5-twin-spoke alloy wheels painted black (code RJ1) for G 350 d only

19" AMG 5-twin-spoke alloy wheels painted matt black (code RK5) in combination with Sports Styling package (code DP8)

20" 5-spoke design AMG alloy wheels painted matt black (including rim flange) with high-sheen finish (code RJ3) for Mercedes-AMG G 63 only

Mirror housings, front and rear bumpers, flared wheel arches and roof in obsidian black, plus outer protective strip inserts in black



¹Not available in conjunction with certain colours: 040 black, 183 magnetite black, 197 obsidian black, 671 designo olive green, 755 tenorite grey, 033 designo mocha black, 041 designo graphite, 046 designo platinum black

Driving Assistance package



Blind Spot Assist



Distance Pilot DISTRONIC

Blind Spot Assist utilises short-range radar sensors to monitor the vehicle's blind spot. If the system detects a vehicle in the blind spot, a red triangle lights up in the respective exterior mirror to alert the driver.

Distance Pilot DISTRONIC is a proximity control system which extends the functionality of the conventional cruise control with variable speed limiter by adding automatic control of the distance to the vehicle ahead.

Driving Assistance package – designed and priced as a package, including items as listed below.

G 350 d and Mercedes-AMG G 63 Total incl. VAT £1,695.00

Driving Assistance package (code DP2)

Blind Spot Assist

Distance Pilot DISTRONIC

Entertainment package



The rear seat entertainment system offers all rear passengers entertainment of a high technical standard. During the journey, rear passengers can watch DVDs by means of the DVD players integrated in the displays or use external entertainment devices such as game consoles. Each screen works independently from the other or content can be played simultaneously.

The TV tuner¹ makes it possible to receive digital terrestrial channels around the world, plus Teletext access, a choice of up to 30 channels, audio playback through speaker and playback through front COMAND screen up to approx. 4 mph.

Entertainment package – designed and priced as a package, including items as listed below.

G 350 d and Mercedes-AMG G 63 Total incl. VAT £2,995.00

Entertainment package (code DP7)

Rear seat entertainment system

TV tuner

¹TV tuner plays through front COMAND screen only

Winter package



Fuel-fired auxiliary heater



Heated windscreen

A fuel-fired heater that operates independently of the engine can be set to heat or ventilate the interior by remote control or by programming the departure time.

The heated windscreen function enables the windscreen to be easily defrosted, or the windscreen and side windows to be demisted, at the touch of a button.

Winter package – designed and priced as a package, including items as listed below.

G 350 d and Mercedes-AMG G 63 Total incl. VAT £1,750.00

Winter package (code DP9)

Auxiliary heater

Heated windscreen

Pricing summary for packages

Model	Transmission	Recommended OTR price (£) ¹					
			Sports Styling package	Night package	Driving Assistance package	Entertainment package	Winter package
G 350 d	7G-TRONIC PLUS 7-speed automatic	92,070.00	95,065.00	94,165.00	93,765.00	95,065.00	93,820.00
Mercedes-AMG G 63	AMG SPEEDSHIFT PLUS 7-speed automatic	135,950.00	-	138,545.00	137,645.00	138,945.00	137,700.00

¹The recommended on-the-road price includes the Road Fund Licence applicable to the standard model plus delivery charge (£635.00 incl. VAT), new vehicle registration fee (£55.00) and number plates (£25.00 incl. VAT). VAT is calculated at the standard rate of 20%

Optional equipment

Item	Notes	G 350 d Mercedes-AMG G 63			Basic RRP excl. VAT (£)	Total RRP incl. VAT (£)
AMG Performance Studio						
AMG Driver's package Includes an increase to your vehicle's electronically limited top speed (144 mph) and participation in one of the AMG BASIC-Training 'Power and Passion' events. The event is run by the AMG Driving Academy and held at a racetrack located in mainland Europe		Z09	-	○	2,079.17	2,495.00
Exterior						
AMG brake calipers, painted silver		BS1	-	○	no-cost option	
Comfort						
Exclusive package Comprising Seat Comfort package, designo black DINAMICA microfibre roof lining and illuminated door sills		PA4	○	●	2,079.17	2,495.00
Universal Telephony package Located in armrest, with universal smartphone cradle, extended telephone functionality, charging function and LTE-compatible exterior aerial for optimum reception		EP3	○	○	291.67	350.00
AMG performance steering wheel in DINAMICA microfibre/nappa leather		CL1	-	○	375.00	450.00
designo red seat belts	Not in conjunction with the Mercedes-AMG G 63 Colour Edition or Mercedes-AMG G 63 EDITION 463	S39	○	○	270.83	325.00
Electric steel sunroof - tilting/sliding, with one-touch opening		F16	○	●	1,383.33	1,660.00



> View offers



Book a

- > test drive
- > AMG test drive



> Find a Retailer



> View the Range Guide

Optional equipment

47

Item	Notes	G 350 d Mercedes-AMG G 63			Basic RRP excl. VAT (£)	Total RRP incl. VAT (£)
Paint, Trim and Upholstery designo Exclusive package designo two-tone leather in a choice of colours, AMG front sports seats, seat and door centre panels in designo leather with diamond design, upper and lower part of dashboard in designo black nappa leather Available in: designo black 501 designo classic red 507 designo porcelain 503 designo light brown 514 designo sand 505 designo titan pearl 518	designo black 501 is optional on the Colour Edition	PA6	-	○	3,133.33	3,760.00
Paint - designo magno allanite grey	Magno matt paint finishes require extra care. Please ask your Retailer for further details	044	○	○	4,870.83	5,845.00
Paint - designo magno paint finishes Available in: designo magno platinum 051 designo magno night black 056	Magno matt paint finishes require extra care. Please ask your Retailer for further details	'	○	○	3,570.83	4,285.00
Paint - designo magno olive green	Magno matt paint finishes require extra care. Please ask your Retailer for further details. Price includes the following detachable body parts painted in black: exterior mirror, wheel arch extension and bumper face bar	671	○	○	2,625.00	3,150.00
Paint - designo metallic paint finishes Available in: designo mauritius blue 039 designo sanidine beige 798 designo tektite grey 753		'	○	○	3,520.83	4,225.00

● Standard ○ Optional - Not available

Item	Notes				Basic RRP excl. VAT (£)	Total RRP incl. VAT (£)
Paint, Trim and Upholstery (continued)						
Paint – designo metallic paint finishes		'	○	○	1,220.83	1,465.00
Available in: designo mocha black 033 designo platinum black 046 designo graphite 041						
Paint – designo mystic white bright		048	○	○	2,845.83	3,415.00
Paint – designo mystic paint finishes		'	○	○	1,975.00	2,370.00
Available in: designo mystic blue 032 designo mystic brown bright 052 designo mystic red bright 037						
Paint – designo non-metallic paint finishes		'	○	○	3,520.83	4,225.00
Available in: desert sand 464 light ivory 623						
Trim – AMG carbon fibre Standard on Mercedes-AMG G 63 Colour Edition and EDITION 463	With wood- and leather-trimmed steering wheel in designo black piano lacquer/black nappa leather	ZG6+ZT1	○	–	4,525.00	5,430.00
			–	○	3,045.83	3,655.00
	With heated nappa leather-trimmed steering wheel	ZG6+VL0	○	–	3,841.67	4,610.00
			–	○	3,045.83	3,655.00
	With AMG performance steering wheel	ZG6	–	○	3,045.83	3,655.00
Trim – anthracite poplar wood	With heated nappa leather-trimmed steering wheel	VL0	○	–	229.17	275.00



> View offers



Book a

- > test drive
- > AMG test drive



> Find a Retailer



> View the Range Guide

Optional equipment

49

Item	Notes	G 350 d Mercedes-AMG G 63		Basic RRP excl. VAT (£)	Total RRP incl. VAT (£)
Paint, Trim and Upholstery (continued)	Trim – designo black piano lacquer	ZG2+ZT1	○ -	2,091.67	2,510.00
			- ○	no-cost option	
	With heated nappa leather-trimmed steering wheel	ZG2+VL0	○ -	1,391.67	1,670.00
			- ○	no-cost option	
	With AMG performance steering wheel	ZG2	- ●	-	-
	Trim – brown burr walnut wood, high-gloss	Includes wood- and leather-trimmed steering wheel in high-gloss brown burr walnut wood/black nappa leather	V56+VK1	○ -	870.83
			- ○	no-cost option	
Trim – designo champagne white piano lacquer	With nappa leather-trimmed steering wheel	ZG8	○ -	1,395.83	1,675.00
			- ○	no-cost option	
	With heated nappa leather-trimmed steering wheel	ZG8+VL0	○ -	1,625.00	1,950.00
			- ○	no-cost option	
With AMG performance steering wheel	ZG8	- ○	no-cost option		
Trim – designo light brown poplar wood	With nappa leather-trimmed steering wheel	ZT0	○ -	1,395.83	1,675.00
			- ○	no-cost option	
	With heated nappa leather-trimmed steering wheel	ZT0+VL0	○ -	1,625.00	1,950.00
			- ○	no-cost option	
With AMG performance steering wheel	ZT0	- ○	no-cost option		

● Standard ○ Optional - Not available

Item	Notes			Basic RRP excl. VAT (£)	Total RRP incl. VAT (£)	
Paint, Trim and Upholstery (continued)						
Upholstery – designo leather		'	○	–	1,333.33	1,600.00
Available in:			–	●	no-cost option	
designo black 501	designo classic red 507					
designo porcelain 503	designo light brown 514					
designo marron 504	designo mystic red 517					
designo sand 505	designo titan pearl 518					
Upholstery – leather		'	○	–	no-cost option	
Available in:						
black 201	alpaca grey 208					
chestnut 204						
Service Package						
Service Care	Price is based on a monthly rate. Example given is for two services taken over 24 months or three services over 36 months. Further payment options are available. New Service Care prices apply only to vehicles up to 12 months old prior to first service. Prices effective from 3 May 2016	'	○	○	50.00	60.00
Service Care allows you to spread the cost of servicing your new car in the Mercedes-Benz Retailer network. Taking out a Service Care plan ensures your servicing needs are taken care of by fully trained Mercedes-Benz Technicians with the added benefit of a Mercedes-Benz service history						

Colours and materials

Metallic paints

Standard



Non-metallic paints

No-cost option



designo metallic paints

Additional-cost option



designo non-metallic paints

Additional-cost option



Colour Edition metallic paints



¹Price includes the following detachable body parts painted in black: exterior mirror, wheel arch extension and bumper face bar (code CK2)

Please note that, owing to limitations of on-screen representation, paint colours may differ from those shown

Trim



Z1 anthracite poplar wood¹



V56 brown burr walnut wood (high-gloss)^{3,4}



ZG6 AMG carbon fibre⁵



ZG2 designo black piano lacquer^{2,3}



ZG8 designo champagne white piano lacquer^{3,4}



ZT0 designo light brown poplar (satin finish)^{3,4}

Upholstery – leather

Standard on G 350 d



201 black

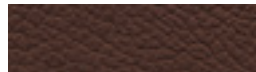

204 chestnut



208 alpaca grey

designo leather

Standard on Mercedes-AMG G 63



501 designo black



507 designo classic red

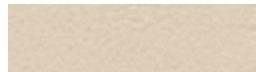

503 designo porcelain



514 designo light brown



504 designo marron



517 designo mystic red



505 designo sand



518 designo titan pearl

designo leather

Standard on Colour Edition



150 tomato red



166 alien green

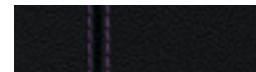

171 galactic beam



173 sunset beam



278 solar beam

designo two-tone leather

Standard on EDITION 463



551 designo black



553 designo porcelain

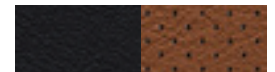

554 designo light brown



> View offers



Book a

- > test drive
- > AMG test drive



> Find a Retailer



> View the Range Guide

Combination options

Leather		Metallic paints										Non-metallic paints															
		183	magnetite black	197	obsidian black	300	periclas green	359	tanzanite blue	541	thulite red	755	tenorite grey	775	iridium silver	792	palladium silver	796	citrine brown	963	indium grey	988	diamond silver	040	jet black	149	polar white
	black	●	●	●	●	●	●	●	●	●	●	●	●	●	●	●	●	●	●	●	●	●	●	●	●	●	●
	chestnut	●	●	○	●	○	●	●	●	●	●	●	●	○	○	●	●	○	○	●	○	○	●	●	●	●	
	alpaca grey	●	●	●	●	●	●	●	●	●	●	●	○	○	●	○	○	○	○	●	○	○	●	●	●	●	

Technical data

	Diesel engine	Petrol engine
Model	G 350 d	Mercedes-AMG G 63
Engine		
Total displacement	cc 2,987	5,461
Arrangement/cylinders/valves	V/6/24	V/8/32
Power ¹	hp (kW) at rpm 245 (180)/3,600	571 (420)/5,500
Torque ¹	Nm at rpm 600/1,600–2,400	760/1,750–5,250
Transmission		
7G-TRONIC PLUS 7-speed automatic	●	-
AMG SPEEDSHIFT PLUS 7G-TRONIC 7-speed auto.	-	●
Performance		
Acceleration 0–62 mph	sec 8.9	5.4
Top speed	mph 119	130

	Diesel engine	Petrol engine
Model	G 350 d	Mercedes-AMG G 63

Weights and capacities

Kerb weight	kg	2,612	2,550
Perm. Gross Vehicle Weight	kg	3,200	3,200
Towing capacity – unbraked braked	kg	3,500 750	3,500 750
Boot capacity Seats down Seats up	l	2,126 699	2,126 660
Fuel tank capacity/of which reserve	l	96/14	96/14
Turning circle kerb to kerb	m	13.6	13.6
Wading depth	mm	600	600

Fuel consumption^{2,3} mpg

Urban	25.5	16.4
Extra-urban ⁴	31.0	23.9
Combined	28.5	20.5

	Diesel engine	Petrol engine
Model	G 350 d	Mercedes-AMG G 63
CO₂ emissions³	g/km	
Emissions standard	EU6	EU6
Standard wheels	261	322

Insurance

Insurance ratings may vary depending on model specification. Please refer to <http://www.thatcham.org/abigrouprating/> for further details

¹Figures according to Directive 80/1269/EEC in the currently applicable version

²All figures are based on a standard specification with the smallest tyre size

³The choice of wheels and transmission may affect CO₂ emissions and corresponding Road Fund Licence

⁴EUDC: extra-urban driving cycle. Testing procedures adhere to EU Directive 93/116

The figures on pages 54–58 are correct at time of publication. Please refer to the government website for latest data – <http://carfueldata.direct.gov.uk/>



> View offers



Book a

- > test drive
- > AMG test drive



> Find a Retailer



> View the Range Guide

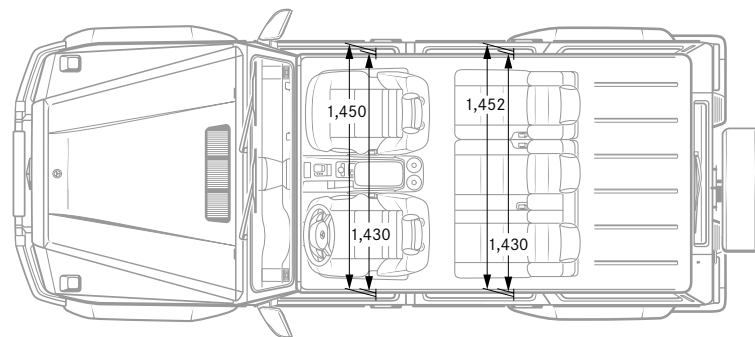
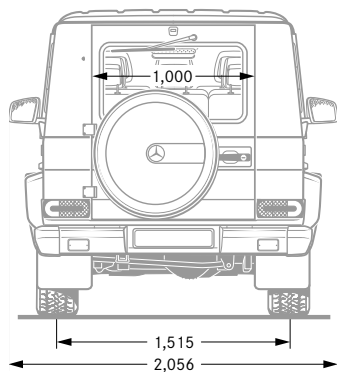
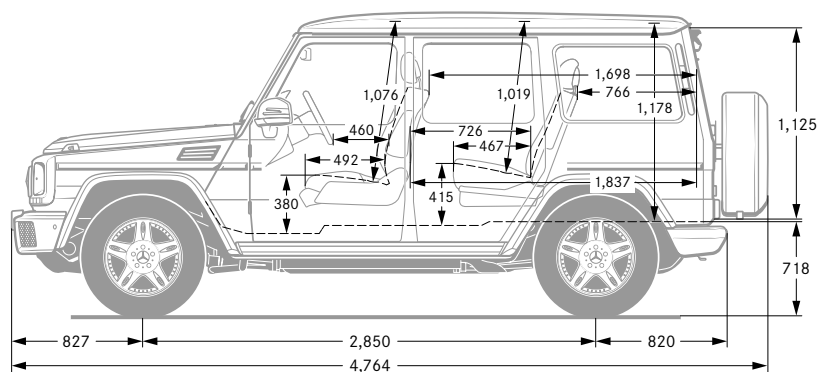
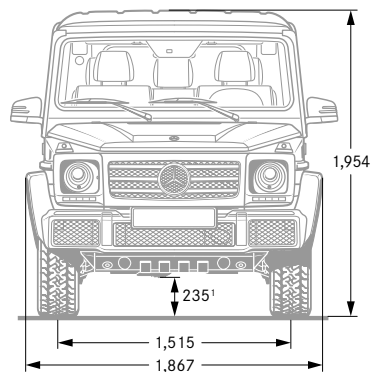

¹At permissible gross vehicle weight

All measurements in millimetres. The dimensions shown are mean values and apply to standard-specification, unladen vehicles. Illustrations may differ from current specification



> View offers



Book a

- > test drive
- > AMG test drive



> Find a Retailer



> View the Range Guide

Off-road capability

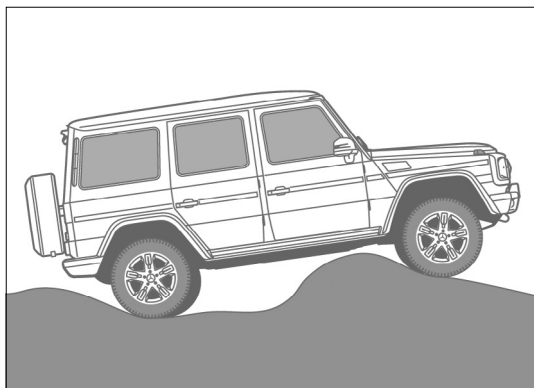

Large ramp breakover angle of 24°

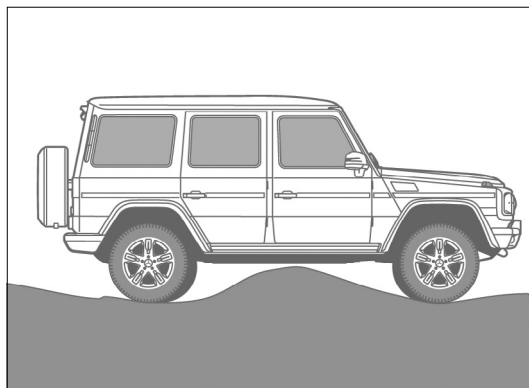

Ground clearance of 21 cm (22 cm on Mercedes-AMG G 63)

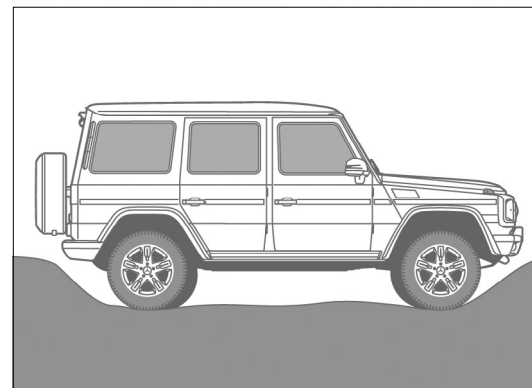

Max. approach angle 36°¹; max. departure angle 27°

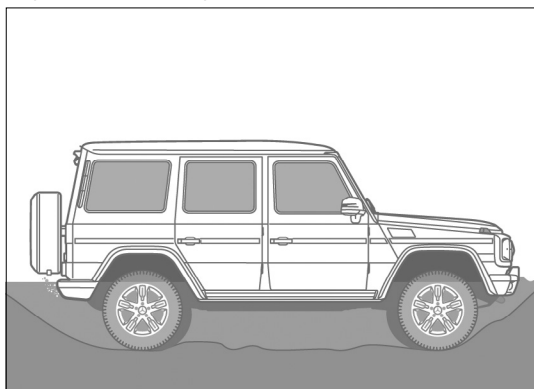

Maximum fording depth of 60 cm

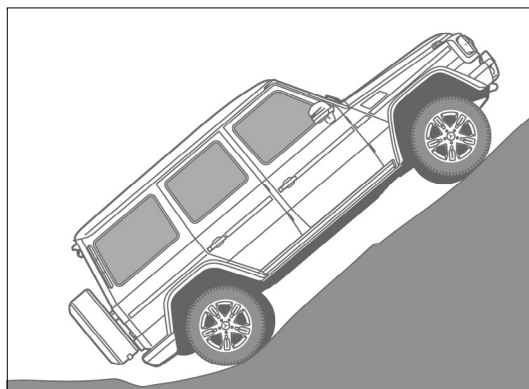

Climbs gradients of up to 80% (surface permitting)

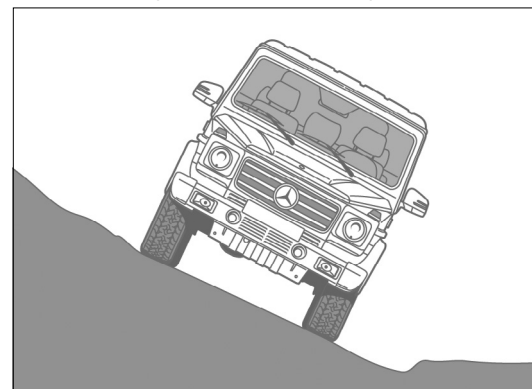

Directionally stable on slopes of up to 54%

¹27° for Mercedes-AMG G 63

Road Fund Licence



All road vehicle registrations are subject to Vehicle Excise Duty (Road Fund Licence), which varies in accordance with the vehicle's CO₂ emissions. A first year rate for each taxation band will apply. The table below shows the bands (A–M) created by the DVLA and the corresponding Road Fund Licence. CO₂ emissions are listed in the technical data on page 56, and the relevant Excise Duty is reflected in the on-the-road prices on page 17.

Band	CO ₂ emissions	First year rate (£)	Standard rate (£)	Premium rate (£) ¹
A	0 g/km	0.00	0.00	310.00
B	1 to 50 g/km	10.00	140.00	450.00
C	51 to 75 g/km	25.00	140.00	450.00
D	76 to 90 g/km	100.00	140.00	450.00
E	91 to 100 g/km	120.00	140.00	450.00
F	101 to 110 g/km	140.00	140.00	450.00
G	111 to 130 g/km	160.00	140.00	450.00
H	131 to 150 g/km	200.00	140.00	450.00
I	151 to 170 g/km	500.00	140.00	450.00
J	171 to 190 g/km	800.00	140.00	450.00
K	191 to 225 g/km	1,200.00	140.00	450.00
L	226 to 255 g/km	1,700.00	140.00	450.00
M	over 255 g/km	2,000.00	140.00	450.00

Some of the model features, optional extras and colours shown may not be available or may only be available in a different specification.

¹Premium rate only applicable to vehicles where the list price is over £40,000 including any factory-fitted options, standard UK delivery charge, number plates, fuel and VAT

Services and insurance

Mercedes-Benz Service Care

We believe that servicing costs should be as flexible and affordable as possible for your G-Class, which is why we offer Service Care, an easy way to budget for all your servicing costs. It spreads your bills into manageable payments based on whether you have a new or used Mercedes-Benz.

With Service Care we guarantee the price of parts and labour for up to three services and safeguard against any further inflation. It also covers the cost of all recommended service items including brake fluid, spark plugs, air filters, fuel filters and screen wash.

You can choose either to add your servicing costs into your monthly spend or pay the full amount in a one-off payment, giving you peace of mind that they are taken care of for the period of the plan.

To receive a personalised Service Care plan recommendation visit the Service Care Calculator at servicecarerates.mercedes-benz.co.uk

Warranty and breakdown cover

Every Mercedes-Benz comes with a three-year unlimited mileage warranty against manufacturing or material defects¹ and up to 30 years warranty against perforation due to corrosion from the inside out². What's more, it's also covered by Mercedes-Benz Roadside Assistance – a unique package comprising up to 30 years pan-European breakdown assistance.²

Insurance

Since our name is synonymous with reliability, who better to trust with your motor insurance? Mercedes-Benz Insurance provides a motor insurance policy specifically designed to give you the cover you would expect from Mercedes-Benz. For a motor insurance quotation, call **0345 600 2180**.*

Mercedes me – the Mercedes that thinks and acts for you

Mercedes me contains a package of innovative services and lifestyle offers that connect you to your car via your desktop, tablet or smartphone using an app. Fitting effortlessly into your daily routine, it provides a wealth of information relevant to you and your Mercedes. It also assists you in the event of a breakdown or an accident.

Mercedes me Live Traffic Information

Live Traffic Information is part of COMAND Online (standard or optional, depending on model).

- **Live Traffic Information** – provides real-time traffic information for dynamic route planning for the first three years from vehicle registration.

In order to access this service, you are required to set up a Mercedes me account, assign your vehicle to your online account and accept the Terms of Use. Your local Retailer will be able to assist and guide you through the registration process. Once your subscription expires after three years, the services of Live Traffic Information can be extended up to three years at an additional charge (1 year = £39.00, 2 years = £69.00, 3 years = £89.00).

To find out more about Mercedes me services and applications, visit the Mercedes me connect store <https://shop.mercedes-benz.com/en-gb/connect> or contact your local Retailer.

Mercedes-Benz Finance

Why should you finance with Mercedes-Benz?

At Mercedes-Benz we believe a great driving experience should be matched by an equally great ownership experience. That is why we put just as much thought, time and effort into designing our finance options, our service plans and our insurance cover as we do into our vehicles.

We are not in the business of simply providing a loan to fund the purchase of your dream vehicle. We look on it as a journey that we take with you, from the moment you choose your new Mercedes-Benz, to helping you in choosing your next one.

If you would like to find out more about any of our current offers, simply call into your local Mercedes-Benz Retailer where one of our Business Managers will be more than happy to talk you through anything you need to know.

Helping you find the right solution.

You should find our finance packages are more convenient than a traditional personal loan because:

- Funds are immediately available – no waiting for cheques or loans to clear.
- There is no security required – either against your home or other assets.
- We have clear and transparent rates – the APR we quote is the APR you get.
- We have friendly Business Managers – experts in vehicle finance who can talk you through all of your plans in detail.

One of our most popular finance products is Mercedes-Benz Agility (our Personal Contract Purchase product). We also offer Contract Hire, Operating Lease and Hire Purchase solutions. If you would like to find out more about these speak to your Retailer or visit www.mercedes-benz.co.uk/fandi.

Mercedes-Benz Agility (our PCP product).

At the start of an Agility agreement, you put down a deposit and decide the term of your agreement and your annual mileage. You will be advised of the Guaranteed Future Value, which offers you the reassurance of knowing exactly what you will need to pay to own the vehicle outright in the future (this is known as the Optional Purchase Payment).

Throughout your agreement you simply pay your agreed monthly payments and when the agreement comes to an end you either purchase, hand back or part-exchange your vehicle.



Agility features:

- Fixed regular payments mean you can easily budget.
- Payments are based only on a proportion of the vehicle's value, keeping your monthly payments lower.
- Our Guaranteed Future Value avoids the risk of unplanned depreciation of your vehicle.
- You defer your ownership decision until the end of the agreement.

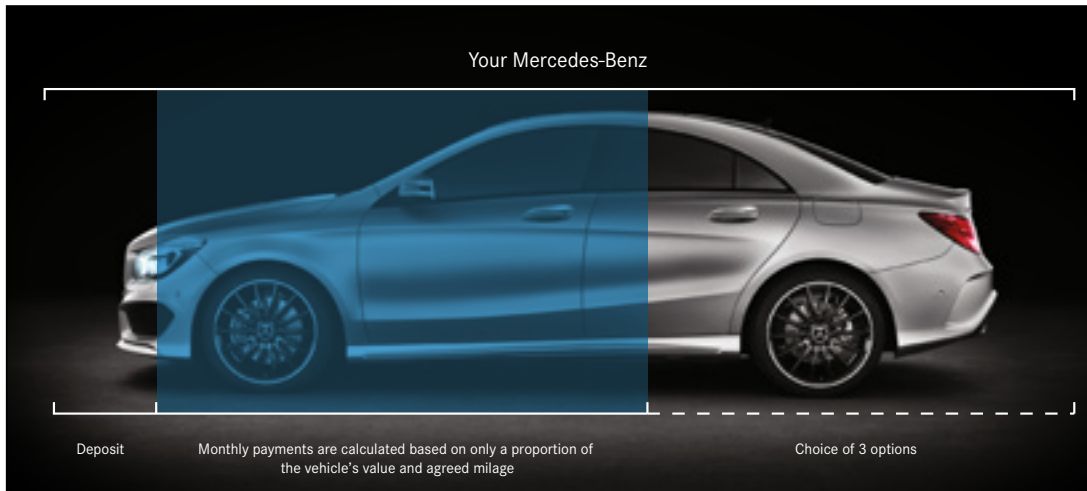

At the end of your agreement you have three options to choose from.

Option 1: Purchase your Mercedes-Benz.

Purchase your Mercedes-Benz by paying the Optional Purchase Payment and Purchase Activation Fee.¹ This will complete the purchase of your Mercedes-Benz, leaving you free to simply enjoy your vehicle.

Option 2: Hand back your Mercedes-Benz.

If you decide to return your vehicle to us, it must be in line with our Vehicle Return Standards,* as vehicle condition, excess mileage and other charges may be payable.

Option 3: Part-Exchange for a new vehicle.

Purchase your Mercedes-Benz by paying the Optional Purchase Payment and Purchase Activation Fee.¹ This will complete the purchase of your Mercedes-Benz, leaving you free to part-exchange for a new vehicle.

¹Please note the 'Purchase Activation Fee' of £10 will be debited from your account *To find out more information about our Vehicle Return Standards please visit <http://mercedes-benz.co.uk/vrs>

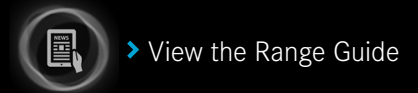
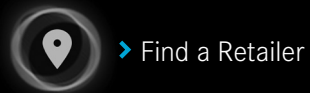
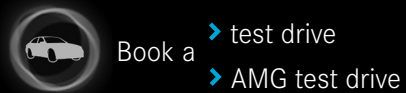

Follow us on the following social media channels:

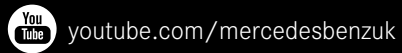
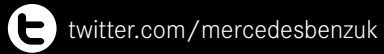
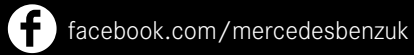

Effective from 1 September 2017 Production. Information correct at time of publication.

Prices and specifications are subject to change without prior notice.

MBW463PL/0517

Mercedes-Benz Cars UK Limited, Tongwell, Milton Keynes, MK15 8BA. Company number 2448457. www.mercedes-benz.co.uk