



[View offers](#)



[Book a test drive](#) [AMG test drive](#)



[Find a Retailer](#)



[View the Range Guide](#)

GLE Coupé



Effective from 11 July 2017 Production.

Mercedes-Benz



Contents

| | | | | | |
|---|----|--|----|------------------------|----|
| Model prices | 10 | Pricing summary for Premium and Premium Plus equipment lines | 28 | Colours and materials | 50 |
| Finance offers | 11 | Standard equipment | 29 | Technical data | 55 |
| AMG Line, designo Line and Mercedes-AMG GLE 43 4MATIC | 15 | Wheels | 37 | Road Fund Licence | 59 |
| Premium and Premium Plus equipment lines | 21 | Driving Assistance Plus package | 39 | Services and insurance | 60 |
| Mercedes-AMG GLE 63 S 4MATIC | 23 | Night package | 40 | Mercedes me | 61 |
| Premium equipment line for Mercedes-AMG GLE 63 S 4MATIC | 25 | Sports package | 41 | Mercedes-Benz Finance | 63 |
| Mercedes-AMG driver training | 26 | Optional equipment | 42 | | |
| | | Genuine Accessories | 46 | | |



> View offers



Book a > test drive > AMG test drive



> Find a Retailer



> View the Range Guide

The hard facts to melt your heart

At Mercedes-Benz we appreciate the importance of detail. Over the following pages you'll find model prices and a breakdown of standard and optional equipment, as well as details of the comprehensive services and benefits that are available to every Mercedes-Benz driver.

See Mercedes-Benz in a new light. Now is the time to get yourself behind the wheel of a GLE Coupé. Choose from a number of attractive finance offers. Please see pages 11–14 for further details, or visit www.mercedes-benz.co.uk/offers

Of course, some things have to be experienced to be truly appreciated, such as the qualities that set a Mercedes-Benz apart. Which is why we'd like to invite you for a test drive at your local Mercedes-Benz Retailer. Alternatively, you can make arrangements by visiting www.mercedes-benz.co.uk/testdrive

For more information visit www.mercedes-benz.co.uk or call 0333 222 0500.



> View offers



Book a > test drive > AMG test drive



> Find a Retailer



> View the Range Guide





[View offers](#)



[Book a test drive](#) [AMG test drive](#)



[Find a Retailer](#)



[View the Range Guide](#)



Some of the model features, optional extras and colours shown may not be available, or may only be available in a different specification.



> View offers



Book a > test drive > AMG test drive



> Find a Retailer



> View the Range Guide



Some of the model features, optional extras and colours shown may not be available, or may only be available in a different specification.



> View offers



Book a > test drive > AMG test drive



> Find a Retailer



> View the Range Guide





[View offers](#)



[Book a test drive](#) [AMG test drive](#)



[Find a Retailer](#)



[View the Range Guide](#)



Some of the model features, optional extras and colours shown may not be available, or may only be available in a different specification.



[View offers](#)



[Book a test drive](#) [AMG test drive](#)



[Find a Retailer](#)



[View the Range Guide](#)



Some of the model features, optional extras and colours shown may not be available, or may only be available in a different specification.



Model prices

| Engine | Model line | Transmission | CO ₂ | Basic RRP excl. VAT (£) | Total RRP incl. VAT (£) | Road Fund Licence (£) ¹ | Rec. OTR price (£) ² | P11D value (£) | BiK tax rate 2017/18 (%) |
|---|--------------|--|-----------------|----------------------------|----------------------------|---------------------------------------|------------------------------------|-------------------|-----------------------------|
| GLE 350 d 4MATIC Diesel – 2,987 cc, 6-cylinder, 258 hp/190 kW | AMG Line | 9G-TRONIC PLUS ³ | 187 | 50,754.17 | 60,905.00 | 800.00 | 62,420.00 | 61,565.00 | 37 |
| | designo Line | 9G-TRONIC PLUS ³ | 187 | 58,500.00 | 70,200.00 | 800.00 | 71,715.00 | 70,860.00 | 37 |
| Mercedes-AMG | | | | | | | | | |
| Mercedes-AMG GLE 43 4MATIC Petrol – 2,996 cc, 6-cylinder, 390 hp/287 kW | - | 9G-TRONIC PLUS ³ | 215 | 52,395.83 | 62,875.00 | 1,200.00 | 64,790.00 | 63,535.00 | 37 |
| | designo Line | 9G-TRONIC PLUS ³ | 215 | 60,141.67 | 72,170.00 | 1,200.00 | 74,085.00 | 72,830.00 | 37 |
| Mercedes-AMG GLE 63 S 4MATIC Petrol – 5,461 cc, 8-cylinder, 585 hp/430 kW | - | AMG SPEEDSHIFT PLUS 7G-TRONIC ³ | 278 | 80,141.67 | 96,170.00 | 2,000.00 | 98,885.00 | 96,830.00 | 37 |

¹A different first year rate of Vehicle Excise Duty (Road Fund Licence) applies for new cars. Please refer to page 59 for the relevant rate for the second and subsequent years

²The recommended on-the-road price includes the Road Fund Licence applicable to the standard model plus delivery charge (£635.00 incl. VAT), new vehicle registration fee (£55.00) and number plates (£25.00 incl. VAT). VAT is calculated at the standard rate of 20%

³ECO start/stop function and SPEEDTRONIC cruise control as standard

Mercedes-Benz Finance

Where the clever money goes

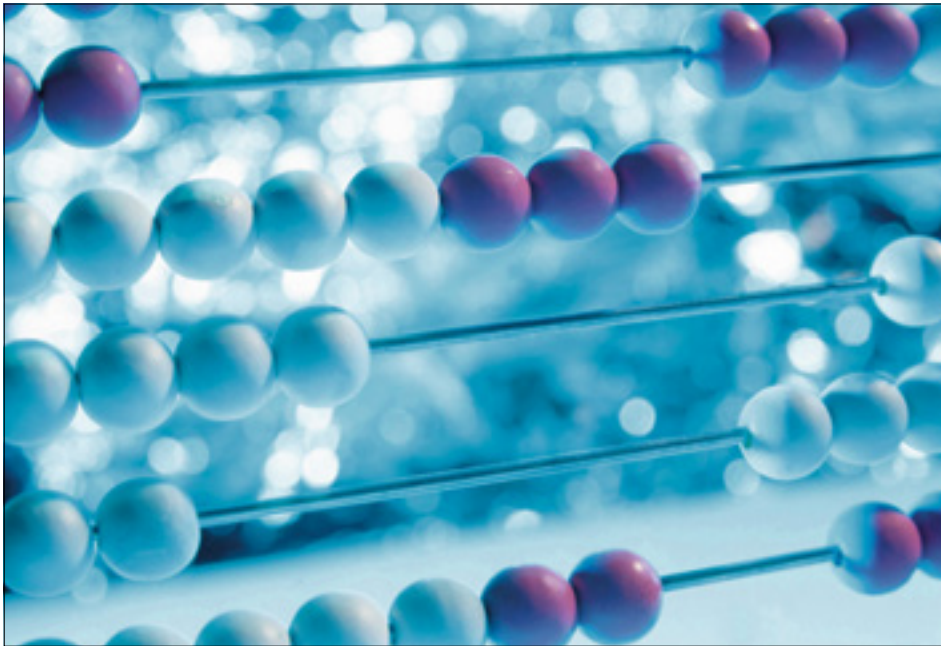

GLE 350 d 4MATIC AMG Line Coupé (representative example)

Based on 10,000 miles per annum

| | |
|--|----------------|
| 36 monthly payments of ¹ | £729.00 |
| Customer deposit | £7,999.00 |
| On-the-road price | £62,420.00 |
| Retailer deposit contribution | £3,582.66 |
| Optional purchase payment ² | £30,475.00 |
| Amount of credit | £50,838.34 |
| Duration of agreement | 36 months |
| Total amount payable ³ | £68,310.66 |
| Purchase activation fee ² | £10.00 |
| APR | 4.9% |
| Fixed interest rate | 4.76% |
| Excess mileage | 22.8p per mile |

**Example offers –
4.9% APR Representative**

| | Automatic | Metallic | On-the-road price | Retailer deposit contribution | Customer deposit | 36 monthly payments of ¹ |
|---------------------------------|-----------|----------|-------------------|-------------------------------|------------------|-------------------------------------|
| GLE 350 d 4MATIC AMG Line Coupé | ● | ● | £62,420.00 | £3,582.66 | £7,999.00 | £729.00 |

● Standard equipment

Mercedes-Benz Service Care

- Mercedes-Benz trained Technicians
- Maintained by Mercedes-Benz Retailers
- Meets requirements of Mercedes-Benz Agility finance agreement

Mercedes-Benz Motor Insurance

- 24/7 UK accident recovery
- We use Mercedes-Benz GenuineParts
- To qualify for up to 10% discount online, go to www.mercedes-benz.co.uk/motorinsurance
- Alternatively, call Mercedes-Benz Motor Insurance now on **0345 600 2180⁴** for an annual quote

We may decline to quote in some circumstances. Mercedes-Benz Motor Insurance is underwritten by Aviva Insurance Limited

Content relating to finance is promoted by Mercedes-Benz Finance. Your Retailer may offer finance on behalf of other companies.

Orders/credit approvals on selected GLE Coupé models only, between 1 July and 30 September 2017, registered by 31 December 2017; excluding Mercedes-AMG models. Some combinations of features/options may not be available. Please contact your local Mercedes-Benz Retailer for availability

¹Based on a Mercedes-Benz Agility agreement. Vehicle condition, excess mileage and other charges may be payable. Quotations available on request for alternative contract lengths and mileages. Guarantees may be required.

Credit provided, subject to status, by Mercedes-Benz Finance, MK15 8BA

²Payable if you exercise the option to purchase the car

³Includes optional purchase payment, purchase activation fee and Retailer deposit contribution (where applicable)

⁴Calls are charged at local rate and may be recorded



Mercedes-Benz Finance

Even the finance offer is beautifully put together

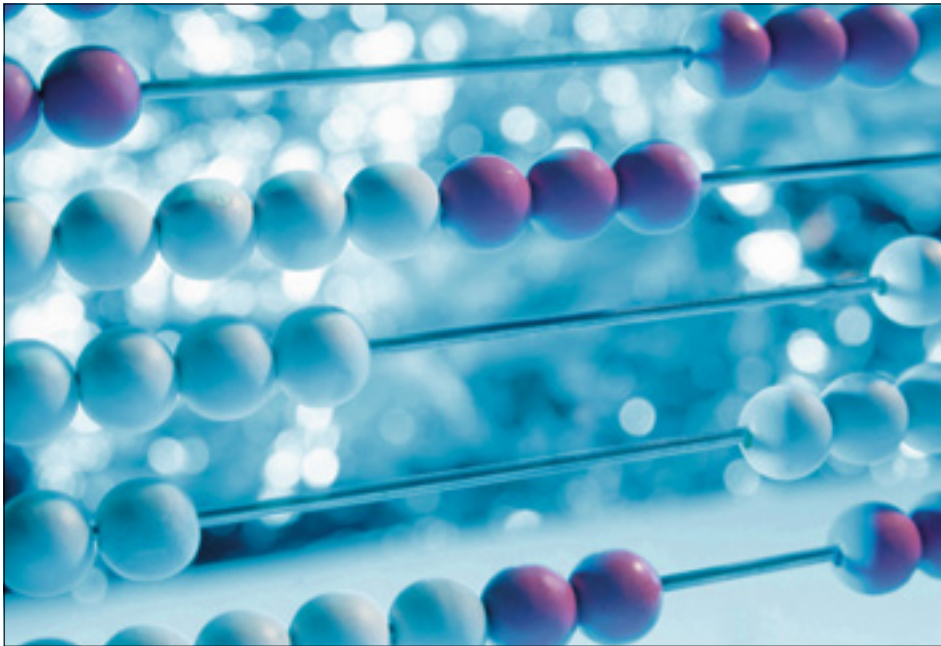

Mercedes-AMG GLE 43 4MATIC Coupé (representative example)

Based on 10,000 miles per annum

| | |
|--|----------------|
| 36 monthly payments of ¹ | £872.59 |
| Customer deposit | £8,999.00 |
| On-the-road price | £64,790.00 |
| Optional purchase payment ² | £31,575.00 |
| Amount of credit | £55,791.00 |
| Duration of agreement | 36 months |
| Total amount payable ³ | £71,997.24 |
| Purchase activation fee ² | £10.00 |
| APR | 5.6% |
| Fixed interest rate | 5.41% |
| Excess mileage | 22.8p per mile |

**Example offers –
4.9% APR Representative**

| | Automatic | Metallic | On-the-road price | Retailer deposit contribution | Customer deposit | 36 monthly payments of ¹ |
|------------------------------------|-----------|----------|-------------------|-------------------------------|------------------|-------------------------------------|
| Mercedes-AMG GLE 63 S 4MATIC Coupé | ● | ● | £98,885.00 | £6,750.00 | £11,999.00 | £1,286.04 |

● Standard equipment

Mercedes-Benz Service Care

- Mercedes-Benz trained Technicians
- Maintained by Mercedes-Benz Retailers
- Meets requirements of Mercedes-Benz Agility finance agreement

Mercedes-Benz Motor Insurance

- 24/7 UK accident recovery
- We use Mercedes-Benz GenuineParts
- To qualify for up to 10% discount online, go to www.mercedes-benz.co.uk/motorinsurance
- Alternatively, call Mercedes-Benz Motor Insurance now on **0345 600 2180⁴** for an annual quote

We may decline to quote in some circumstances. Mercedes-Benz Motor Insurance is underwritten by Aviva Insurance Limited

Content relating to finance is promoted by Mercedes-Benz Finance. Your Retailer may offer finance on behalf of other companies.

Orders/credit approvals on selected Mercedes-AMG GLE43 and GLE 63 S Coupé models only, between 1 July and 30 September 2017, registered by 31 December 2017; excluding non-Mercedes-AMG models. Some combinations of features/options may not be available. Please contact your local Mercedes-Benz Retailer for availability

¹Based on a Mercedes-Benz Agility agreement. Vehicle condition, excess mileage and other charges may be payable. Quotations available on request for alternative contract lengths and mileages. Guarantees may be required.

Credit provided, subject to status, by Mercedes-Benz Finance, MK15 8BA

²Payable if you exercise the option to purchase the car

³Includes optional purchase payment, purchase activation fee and Retailer deposit contribution (where applicable)

⁴Calls are charged at local rate and may be recorded



[View offers](#)



[Book a test drive](#) [AMG test drive](#)



[Find a Retailer](#)



[View the Range Guide](#)

GLE AMG Line

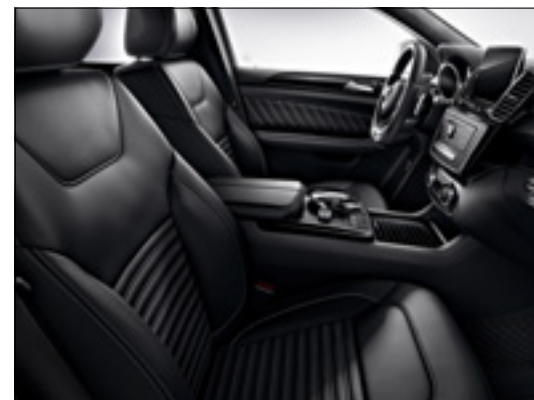

Muscular, innovative, striking SUV dynamics are at the core of the new Mercedes-Benz GLE Coupé. The GLE AMG Line pairs these attributes with an athletic diesel engine, unique AMG styling features and a vast array of technological gems. On the exterior, you'll notice the 21" AMG alloy wheels, AMG bodystyling on front and rear bumpers as well as the beltline trim with chrome-look finish. The interior sets the scene with nappa leather upholstery

and a brushed light aluminium trim. The AMG sports steering wheel also features nappa leather and a flattened bottom rim, plus DIRECT SELECT steering wheel gearshift paddles for the new 9G-TRONIC automatic transmission. AIRMATIC air suspension with Adaptive Damping System and DYNAMIC SELECT with a choice of driving modes to suit the terrain you're in, ensure a highly smooth, yet engaging drive.

Exterior

- Mirror package – including projection of Mercedes-Benz logo integrated into both mirrors
- Active Parking Assist incl. PARKTRONIC and reversing camera
- AIRMATIC air suspension with Adaptive Damping System
- AMG bodystyling
- DYNAMIC SELECT with a choice of four driving modes
- EASY-PACK powered tailgate
- Headlamps – LED Intelligent Light System
- Privacy glass

Interior

- 3-spoke AMG sports steering wheel in black nappa leather with flattened bottom rim
- Ambient lighting with a choice of three colours: neutral (white), solar (amber), polar (ice blue)
- AMG floor mats with 'AMG' lettering
- COMAND Online system with multi-touch control touchpad
- DAB digital radio tuner
- Double sun visors with illuminated vanity mirrors
- Front seats – heated
- KEYLESS-GO starting function
- THERMATIC – automatic climate control

Trim and Upholstery

Brushed light aluminium



Nappa leather – pearl black/black



Nappa leather – pearl black/black with red stitching



Nappa leather – porcelain/black





[View offers](#)



[Book a test drive](#) [AMG test drive](#)



[Find a Retailer](#)



[View the Range Guide](#)

GLE designo Line



The designo Line adds a range of exclusive features to the GLE Coupé whilst retaining the AMG Line's distinctive exterior styling. The exterior sports a panoramic electric sunroof, while Active Parking Assist including PARKTRONIC and a 360° camera aids scratch-free parking. The interior stands out with its very own designo Interior package. It includes designo Exclusive

porcelain upholstery, black high-gloss poplar wood trim, as well as a roof lining in black DINAMICA microfibre. All the seats can be heated, and the multi-contour front seats with massage function are climatized for all-year comfort. This sporty coupé also comes with interior air ionisation with air filter.

Exterior

- Active Parking Assist including PARKTRONIC and 360° camera
- Closing aid for doors and boot lid
- Panoramic electric sunroof with interior sun blind
- Running boards – illuminated, with rubber studs

Interior

- Memory package – including driver's seat, front passenger seat, steering column and exterior mirrors, all electrically adjustable with memory
- designo Interior package
- KEYLESS-GO Comfort package
- Cup holder – temperature controlled, for driver and front passenger
- Front seats – climatized
- Front seats – multi-contour seats with massage function
- Heated multifunction steering wheel
- Interior air ionisation with air filter
- Rear seats – heated
- Surround sound system – Harman Kardon® Logic 7® with Dolby Digital 5.1 and DTS
- THERMOTRONIC – luxury automatic climate control

Trim and Upholstery

Black high-gloss poplar wood



designo Exclusive nappa leather – porcelain/black





[View offers](#)



[Book a test drive](#) [AMG test drive](#)



[Find a Retailer](#)



[View the Range Guide](#)

Mercedes-AMG GLE 43 4MATIC

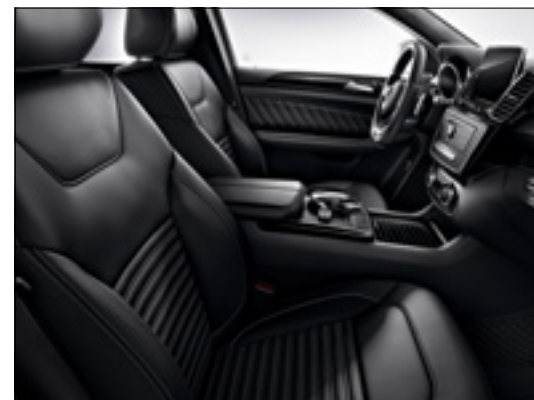

The Mercedes-AMG GLE 43 4MATIC is powered by a highly responsive 6-cylinder petrol engine delivering 390 hp (287kW). The exterior is enhanced with athletic elements like the AMG rear spoiler in vehicle colour, as well as a two-pipe exhaust system with chrome-plated tailpipe trims. Like the diesel model, the Mercedes-AMG GLE 43 4MATIC also comes with DYNAMIC SELECT, but adds another driving mode, 'Sport+', for a more dynamic ride.

Active Parking Assist including PARKTRONIC and reversing camera are also standard features on this striking GLE Coupé. Inside, the sports seats with AMG bolsters can be fitted with pearl black or black nappa leather and lugano leather set against brushed light aluminium trim. The sporty theme is matched by the AMG sports steering wheel, AMG floor mats and the instrument cluster with chequered flag design.

Exterior

- Mirror package – including projection of Mercedes-Benz logo integrated into both mirrors
- Night package
- Active Parking Assist incl. PARKTRONIC and reversing camera
- AIRMATIC air suspension with Adaptive Damping System
- AMG bodystyling
- AMG rear spoiler in vehicle colour on the boot lid
- AMG-specific 4MATIC all-wheel drive
- AMG sports exhausts with twin tailpipes
- DYNAMIC SELECT with a choice of five driving modes
- EASY-PACK powered tailgate
- Exhaust system with sporty engine including backfire sound
- Headlamps – LED Intelligent Light System
- Suspension based on Mercedes-AMG model

Interior

- 3-spoke AMG sports steering wheel in black nappa leather with flattened bottom rim
- Ambient lighting with a choice of three colours: neutral (white), solar (amber), polar (ice blue)
- DAB digital radio tuner
- Double sun visors with illuminated vanity mirrors
- Front seats – heated
- KEYLESS-GO starting function
- THERMATIC – automatic climate control

Trim and Upholstery

- Brushed light aluminium
- Nappa leather – pearl black/black
- Nappa leather – pearl black/black with red stitching
- Nappa leather – porcelain/black

Premium and Premium Plus equipment lines



Active Parking Assist including PARKTRONIC and 360° camera



Memory package



Panoramic electric sunroof

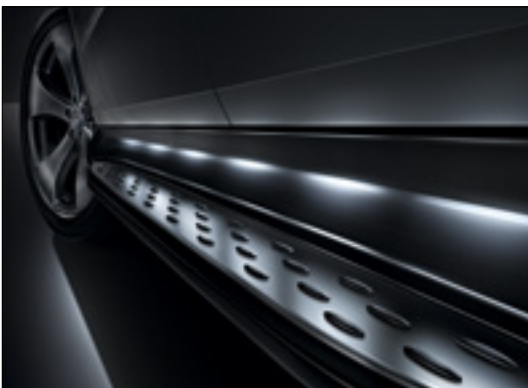

Running boards - illuminated, with rubber studs



Harman Kardon® Logic 7® surround sound system



KEYLESS-GO Comfort package

Once you've decided on a GLE Coupé you will find that it has yet more to offer. True to its name, the Premium equipment line holds a range of features to enhance comfort and convenience. The Premium Plus equipment line maximises your comfort by adding the KEYLESS-GO Comfort package and the Harman Kardon® Logic 7® surround sound system.

Premium and Premium Plus equipment lines¹ – designed and priced as a package, including items as listed below.

Premium **Total incl. VAT £2,795.00**
Premium Plus **£3,995.00**

| Item | Notes | Premium ¹ £2,795.00 ² (code DPO) | Premium Plus ¹ £3,995.00 ² (code DP1) |
|---|---|--|---|
| Parking Pilot and 360° camera | Parking Pilot makes finding a parking space easier, as well as entering or leaving parallel or on-end parking spaces. The 360° camera enables parking and manoeuvring with a realistic all-round view thanks to the interaction of four networked cameras | ■ | ■ |
| Memory package | Driver's seat, passenger seat, steering column and exterior mirrors – electrically adjustable with memory | ■ | ■ |
| Panoramic electric sunroof | Consisting of a fixed panoramic glass rear section and an electrically operated sliding glass front section, allowing additional light and ventilation into the vehicle | ■ | ■ |
| Running boards – illuminated, with rubber studs | Aluminium-look running boards mounted on the side at the height of the side skirts. Slip-resistant rubber studs ensure a firm foothold. Easier to get into both front and rear | ■ | ■ |
| Harman Kardon® Logic 7® surround sound system | Powerful multi-channel DSP amplifier with up to 830 watts as well as 14 high-performance speakers for precision dynamics and excellent sound balance | – | ■ |
| KEYLESS-GO Comfort package | The vehicle can be conveniently unlocked, started and locked – simply by carrying the electronic key | – | ■ |



[View offers](#)



[Book a test drive](#) [AMG test drive](#)



[Find a Retailer](#)



[View the Range Guide](#)

Mercedes-AMG GLE 63 S 4MATIC



Image shown includes running boards which are part of the Premium equipment lines

This unique GLE Coupé carries the bold signature of Mercedes' driving performance experts, AMG. Apart from the 'V8 BITURBO' lettering on the front wings, you can't miss the 22" AMG black alloy wheels, the largest ever produced by Mercedes-AMG. The front apron features an A-wing in high-gloss black, a front splitter painted in the vehicle colour, silver chrome inserts and large cooling air intakes. For the most rewarding dynamic drive, there's the AMG sports suspension with Adaptive Damping System and

the ACTIVE CURVE SYSTEM which enhances ride comfort, agility and safety. The interior is brimming with luxurious AMG touches, starting with AMG Exclusive nappa leather upholstery and alpaca grey topstitching on the AMG sports seats, as well as a nappa leather trim. As you'd expect, there's also an AMG performance steering wheel. Plus, the 4.4-inch AMG instrument cluster lights up in red.

Exterior

Mirror package - including projection of Mercedes-Benz logo integrated into both mirrors

22" AMG alloy wheels (4) - multi-spoke design, painted in titanium grey with high-shine finish

Active Parking Assist incl. PARKTRONIC and reversing camera

AMG sports suspension based on AIRMATIC with ACTIVE CURVE SYSTEM features advanced adjustable damping and roll compensation

DYNAMIC SELECT with a choice of driving modes

High-performance braking system with red brake calipers

Panoramic electric sunroof with interior sun blind

S-Model AMG front and rear aprons

Interior

Memory package

Ambient lighting with a choice of three colours: neutral (white), solar (amber), polar (ice blue)

AMG floor mats with 'AMG' lettering

AMG instrument cluster

AMG performance steering wheel

Surround sound system - Harman Kardon® Logic 7® with Dolby Digital 5.1 and DTS

Trim and Upholstery

Brushed light aluminium

AMG Exclusive nappa leather - black with grey stitching

AMG Exclusive nappa leather - porcelain/black

AMG Exclusive nappa leather - espresso brown/black

Premium equipment line for Mercedes-AMG GLE 63 S 4MATIC

Given that the GLE Coupé is a thing of beauty in its own right, you might think that there isn't much room for improvement. But if you want to increase the comfort and convenience of your GLE 63 S 4MATIC, the Premium equipment line does just that.

Premium equipment line – designed and priced as a package, including items as listed below.

Mercedes-AMG GLE 63 S 4MATIC

Total incl. VAT £3,295.00

| Item | Notes | Premium £3,295.00 ¹ (code DPO) |
|---|---|---|
| Parking Pilot and 360° camera | Parking Pilot makes finding a parking space as well as parking in and leaving parallel or on-end parking spaces easier. The 360° camera enables parking and manoeuvring with a realistic all-round view thanks to the interaction of four networked cameras | ■ |
| Closing aid for doors and boot lid | When initially engaged, doors and boot lid are automatically closed by servo motors, ensuring smooth and virtually silent closing | ■ |
| Front seats – climatized | The active ventilation function of the climate-controlled seats rapidly cools the seat surfaces to a pleasant temperature to ensure well-balanced seating comfort. In cold weather conditions, the on-demand seat heating provides cosy warmth as required | ■ |
| Front seats – multi-contour, with massage function ² | Driver and front passenger can use various air chambers to individually adjust their seats to suit their personal physique – from seat cushion depth via the side bolsters to the position and curvature of the backrest. The massage function with seven zones and two selectable intensity settings helps to avoid muscle tension | ■ |
| Interior air ionisation with air filter | This system helps to significantly improve the quality of the air in the vehicle interior. Ionisation has a refreshing effect and can contribute to an enhanced sense of well-being. The filter system has two fine-particle activated charcoal filters for a particularly comprehensive reduction of harmful substances and odours | ■ |
| KEYLESS-GO Comfort package | The vehicle can be conveniently unlocked, started and locked with this system – simply by carrying the electronic key | ■ |
| Running boards - illuminated, with rubber studs | Aluminium-look running boards mounted on the side at the height of the side skirts. Slip-resistant rubber studs ensure a firm foothold. Easier to get into the front and rear | ■ |



> View offers



Book a > test drive > AMG test drive



> Find a Retailer



> View the Range Guide

Exclusive driver training for Mercedes-AMG GLE 63 S owners

All Mercedes-AMG GLE 63 S 4MATIC customers are invited to a complimentary AMG Driving Academy Training experience at Mercedes-Benz World.



With friendly one-to-one tuition from a professional Mercedes-AMG driver, your training will be personalised to you. You'll push Mercedes-AMG driving performance and your driving skills to the limits on our track and purpose-built low friction dynamic handling facilities.

Through high-speed and adrenaline-fuelled exercises you'll experience oversteer, understeer, slaloms and many more performance driving skills. Designed as part of your ownership experience, this will lay the foundations to master a high-performance vehicle, develop driving skills with maximum enjoyment and prepare you to take full command of your own Mercedes-AMG.

TERMS AND CONDITIONS

The following only are eligible: the first purchaser/registered keeper of a newly-registered Mercedes-AMG GLE 63 S 4MATIC; the second owner/registered keeper of a Mercedes-AMG purchased from a Mercedes-Benz Retailer, where the vehicle is less than 90 days from registration. The AMG Driving Academy Training experience is the AMG-PERFORMANCE Training detailed in the further information above and must be booked and taken within six months of delivery of your Mercedes-AMG GLE 63 S 4MATIC; it cannot be exchanged and cannot be transferred for any other driving experience. The Training experience is available Monday to Friday only and is subject to availability. Mercedes-Benz UK Limited reserves the right to amend or withdraw this Training experience. Attendees must hold a full UK driving licence. Attendees will be required to sign the Mercedes-Benz World Driving Risk Acknowledgement prior to undertaking the Training experience. The Training experience is also subject to the Mercedes-Benz World Terms and Conditions, as applicable.



> View offers



Book a > test drive > AMG test drive



> Find a Retailer



> View the Range Guide



Pricing summary for Premium and Premium Plus equipment lines

| Model | Transmission | Recommended OTR price (£) ¹ | | |
|------------------------------|-------------------------------|--|----------------------|---------------------------|
| | | | Premium | Premium Plus |
| GLE 350 d 4MATIC AMG Line | 9G-TRONIC PLUS | 62,420.00 | 65,215.00 | 66,415.00 |
| Mercedes-AMG GLE 43 4MATIC | 9G-TRONIC PLUS | 64,790.00 | 67,585.00 | 68,785.00 |
| | | Mercedes-AMG | Mercedes-AMG Premium | Mercedes-AMG Premium Plus |
| Mercedes-AMG GLE 63 S 4MATIC | AMG SPEEDSHIFT PLUS 7G-TRONIC | 98,885.00 | 102,180.00 | - |

¹The recommended on-the-road price includes the Road Fund Licence applicable to the standard model plus delivery charge (£635.00 incl. VAT), new vehicle registration fee (£55.00) and number plates (£25.00 incl. VAT). VAT is calculated at the standard rate of 20%

Standard equipment



Reversing camera



Touchpad



EASY-PACK powered tailgate



Headlamps – LED Intelligent Light System



Mirror package – including projection of Mercedes-Benz logo



KEYLESS-GO starting function



| Item | AMG Line | designo Line | Mercedes-AMG GLE 43 | Mercedes-AMG GLE 63 S |
|---|----------|--------------|---------------------|-----------------------|
| Transmission and Suspension | | | | |
| 9G-TRONIC automatic transmission with steering column gear selector, DIRECT SELECT steering wheel gearshift paddles, cruise control and speed limiter | ● | ● | ● | - |
| AMG SPEEDSHIFT PLUS 7G-TRONIC automatic transmission with steering column gear selector, DIRECT SELECT steering wheel gearshift paddles, cruise control and speed limiter | - | - | - | ● |
| ACTIVE CURVE SYSTEM Enhances ride comfort, agility and safety at high speed, when cornering and when driving off-road | - | - | - | ● |
| AIRMATIC air suspension with Adaptive Damping System | ● | ● | ● | - |
| AMG sports suspension based on AIRMATIC with Adaptive Damping System | - | - | - | ● |
| DYNAMIC SELECT with a choice of driving modes: 'Comfort', 'Sport', 'Slippery' and 'Individual' | ● | ● | - | - |
| DYNAMIC SELECT with a choice of driving modes: 'Comfort', 'Sport', 'Sport+', 'Slippery' and 'Individual' | - | - | ● | ● |
| ECO start/stop function | ● | ● | ● | ● |
| Permanent four-wheel drive | ● | ● | ● | ● |

| Item | AMG Line | designo Line | Mercedes-AMG GLE 43 | Mercedes-AMG GLE 63 S |
|---|----------|--------------|---------------------|-----------------------|
| Steering | | | | |
| 3-spoke AMG sports steering wheel in black nappa leather with flattened bottom rim | ● | - | ● | - |
| 3-spoke heated multifunction steering wheel | - | ● | - | - |
| 4-spoke AMG performance steering wheel in black nappa leather / DINAMICA microfibre | - | - | - | ● |
| Sports Direct-Steer system with speed-sensitive power assistance | ● | ● | ● | ● |
| Steering column - manually adjustable for height and reach | ● | - | ● | - |

Standard equipment

| Item | AMG Line | designo Line | Mercedes-AMG GLE 43 | Mercedes-AMG GLE 63 S |
|---|----------|--------------|---------------------|-----------------------|
| Exterior | | | | |
| Mirror package Including heated exterior mirrors, automatically dimming rear view mirror and exterior mirror on driver's side, electrically folding exterior mirrors left and right, and projection of Mercedes-Benz logo integrated into both mirrors | ● | ● | ● | ● |
| Parking Pilot with 360° camera The Parking Pilot makes finding a parking space as well as parking in and leaving parallel or on-end parking spaces easier. The 360° camera enables parking and manoeuvring with a realistic all-round view thanks to the interaction of four networked cameras | ○ | ● | ○ | ○ |
| Parking Pilot and reversing camera The Parking Pilot monitors the front and rear end while the driver is manoeuvring the vehicle and gives a warning if the risk of a collision is detected. Active Parking Assist makes it easier to find a parking space and also automatically steers the vehicle into parking spaces | ● | - | ● | ● |
| Adaptive Highbeam Assist Plus | ● | ● | ● | ● |
| AMG bodystyling - front and rear bumpers | ● | ● | ● | - |
| AMG bodystyling with exclusive GLE 63 S 4MATIC front and rear aprons | - | - | - | ● |
| AMG rear spoiler in vehicle colour | - | - | ● | ● |
| Beltline trim with chrome-look finish | ● | ● | - | ● |
| Brake calipers - painted red, with 'AMG' lettering | - | - | - | ● |

| Item | AMG Line | designo Line | Mercedes-AMG GLE 43 | Mercedes-AMG GLE 63 S |
|---|----------|--------------|---------------------|-----------------------|
| Closing aid for doors and boot lid Power closing ensures smooth and virtually silent closing. Once they have initially engaged, the front and rear doors are automatically drawn closed by servomotors | - | ● | - | ○ |
| Diesel Particulate Filter (DPF) | ● | ● | - | - |
| EASY-PACK powered tailgate The EASY-PACK boot lid can be opened and closed at the touch of a button for more convenient loading and unloading of the boot | ● | ● | ● | ● |
| Exhaust system - twin-pipe, with two integrated black tailpipe trims | - | - | ● | - |
| Headlamps - LED Intelligent Light System LED headlamps, high beam and direction indicator LED position light, cornering light and daytime running lamps Dynamic headlamp range adjustment for ideal visibility in all weather, lighting and driving conditions Variable light distribution for driving on country roads and motorways as well as in heavy fog Active light function allows headlamps to pivot into bends by up to 15° to illuminate road surface more effectively, improving visibility Cornering light function: two LEDs per headlamp improve road illumination in tight bends by automatically switching on cornering light on the relevant side Enhanced fog lamp function illuminates outer half of the carriageway more effectively while reducing glare due to light reflected by fog. Can be activated at speeds below 44 mph and remains switched on up to 62 mph Welcome home function lights up LED fibre optics in the headlamps in blue after unlocking the vehicle, transitioning to white locator lighting | ● | ● | ● | ● |



| Item | AMG Line | designo Line | Mercedes-AMG GLE 43 | Mercedes-AMG GLE 63 S |
|---|----------|--------------|---------------------|-----------------------|
| Exterior (continued) | | | | |
| Heated windscreen washer system | ● | ● | ● | ● |
| LED tail lamps | ● | ● | ● | ● |
| Panoramic electric sunroof with interior sun blind | ○ | ● | ○ | ● |
| Privacy glass – dark glass from B-pillar backwards | ● | ● | ● | ● |
| Rain-sensing wipers | ● | ● | ● | ● |
| Rear screen wash/wiper | ● | ● | ● | ● |
| Running boards – illuminated, with rubber studs | ○ | ● | ○ | ○ |
| Third brake lamp – LED technology | ● | ● | ● | ● |
| Tinted glass all round – single-layer safety glass | ● | ● | ● | ● |
| Underbody protection with chrome-look finish front and rear | ● | ● | ● | ● |
| ‘V8 BITURBO’ lettering on front wings | - | - | - | ● |

| Item | AMG Line | designo Line | Mercedes-AMG GLE 43 | Mercedes-AMG GLE 63 S |
|---|----------|--------------|---------------------|-----------------------|
| Interior | | | | |
| designo Interior package designo seats with diamond stitching and designo badge, dashboard and door trim in designo leather, roof lining in black DINAMICA microfibre, double sun visors in black DINAMICA microfibre, designo floor mats | - | ● | - | - |
| KEYLESS-GO Comfort package Vehicle can be conveniently unlocked, started and locked with this system – simply by carrying the electronic key | ○ | ● | ○ | ○ |
| Memory package Driver’s seat, front passenger seat, steering column and exterior mirrors – electrically adjustable with memory | ○ | ● | ○ | ● |
| 12 V socket in front and rear of centre console and in load compartment | ● | ● | ● | ● |
| Ambient lighting Illumination for double cup holder, rear footwells, rotary air vent controls, front door sill panels with ‘Mercedes-Benz’ lettering illuminated in white (‘AMG’ lettering for GLE 63 S 4MATIC), warning/courtesy lights in the rear. With a choice of three colours: neutral (white), solar (amber), polar (ice blue) | ● | ● | ● | ● |
| AMG door sill panels in brushed stainless steel with ‘AMG’ lettering | - | - | - | ● |
| AMG floor mats with ‘AMG’ lettering | ● | - | ● | ● |
| AMG instrument cluster with large (4.4-inch) multifunction display and AMG main menu with red highlights | - | - | - | ● |



| Item | AMG Line | designo Line | Mercedes-AMG GLE 43 | Mercedes-AMG GLE 63 S |
|--|----------|--------------|---------------------|-----------------------|
| Interior (continued) | | | | |
| AMG sports seats with AMG-specific seat upholstery layout, optimised lateral support and AMG badge in front seat backrests | - | - | - | ● |
| Centre armrests – front, with stowage compartment | ● | ● | ● | ● |
| Centre armrests – rear, folding | ● | ● | ● | ● |
| Cup holders – front (2) and rear (2) | ● | ● | ● | ● |
| Cup holders – temperature-controlled for driver and front passenger | - | ● | - | ● |
| Dashboard – upper part in ARTICO leather ¹ | ● | - | ● | - |
| Dashboard – upper part in nappa leather | - | ● | - | ● |
| Door sill panels with 'Mercedes-Benz' lettering | ● | ● | ● | - |
| Double sun visors with illuminated vanity mirrors | ● | ● | ● | ● |
| Front seats – full electric adjustment (backrest, height and longitude) with four-way electric lumbar support | ● | ● | ● | ● |
| Front seats – heated | ● | - | ● | ● |
| Front seats – climatised | - | ● | - | ○ |
| Front seats – multi-contour seats with massage function | - | ● | - | ○ |
| Front seats – sports seats with AMG bolsters in nappa leather and lugano leather | ● | - | ● | - |

| Item | AMG Line | designo Line | Mercedes-AMG GLE 43 | Mercedes-AMG GLE 63 S |
|--|----------|--------------|---------------------|-----------------------|
| Head restraints – manually adjustable, front and rear | ● | ● | ● | ● |
| Instrument cluster with chequered flag design | ● | - | ● | - |
| Interior air ionisation with air filter | - | ● | - | ○ |
| KEYLESS-GO starting function | ● | ● | ● | ● |
| Luggage compartment cover | ● | ● | ● | ● |
| Reading lights – front and rear | ● | ● | ● | ● |
| Rear seats – heated | - | ● | - | ● |
| Rear seats – split folding 1/3:2/3 | ● | ● | ● | ● |
| Sports pedals in brushed stainless steel with rubber studs | ● | - | ● | ● |
| THERMATIC – automatic climate control | ● | - | ● | - |
| THERMOTRONIC – luxury automatic climate control Multi-zone function with separate air distribution settings for driver/front passenger and rear. Three different climate modes: Focused, Medium and Diffuse | - | ● | - | ● |

Standard equipment

| Item | AMG Line | designo Line | Mercedes-AMG GLE 43 | Mercedes-AMG GLE 63 S |
|--|----------|--------------|---------------------|-----------------------|
| Paint, Trim and Upholstery | | | | |
| Paint – non-metallic and metallic | ● | ● | ● | ● |
| Trim – black high-gloss poplar wood | - | ● | - | - |
| Trim – brushed light aluminium | ● | - | ● | ● |
| Upholstery – nappa leather | ● | - | ● | - |
| Upholstery – designo Exclusive nappa leather | - | ● | - | - |
| Upholstery – AMG Exclusive nappa leather | - | - | - | ● |

| Item | AMG Line | designo Line | Mercedes-AMG GLE 43 | Mercedes-AMG GLE 63 S |
|--|----------|--------------|---------------------|-----------------------|
| Communications and In-Car Entertainment | | | | |
| Bluetooth® interface for hands-free telephony and audio streaming for music transmission | ● | ● | ● | ● |
| Central controller dial to operate audio functions and telephone (when connected) | ● | ● | ● | ● |
| COMAND Online system with Media Interface and touchpad ¹ Includes radio, single CD/DVD, 8 speakers, 8-inch colour display, hard disk drive (HDD) navigation with 3D map display, Live Traffic Information and European map data updates free of charge for the first three years and LINGUATRONIC voice control. Internet-enabled mobile phone required for emergency call system (eCall), Mercedes-Benz apps and in-car internet access for Facebook, internet radio, sending routes from Google Maps™ to the vehicle, news and weather reports. Also includes SD memory card slot and MP3 compatibility. Media Interface allows connection and control of portable media devices (e.g. MP3 player, USB storage media) | ● | ● | ● | ● |
| DAB digital radio tuner | ● | ● | ● | ● |
| Mercedes me connect services – for example accident recovery, breakdown management and maintenance management, or telediagnosics for worn parts | ● | ● | ● | ● |
| Remote Online technical preparation for the use of Mercedes me connect services – for example remote query, vehicle status, vehicle location, etc., possible via smartphone | ● | ● | ● | ● |

| Item | AMG Line | designo Line | Mercedes-AMG GLE 43 | Mercedes-AMG GLE 63 S |
|--|----------|--------------|---------------------|-----------------------|
| Communications and In-Car Entertainment (continued) | | | | |
| Smartphone integration Comprising Apple CarPlay™ and Android Auto. Please check on www.apple.com/uk/ios/carplay/ or www.android.com/intl/en_uk/auto for compatibility and approved apps. Certain features and apps require a 3G or 4G data connection. Control of features available through voice control and controller on centre console | ● | ● | ● | ● |
| Surround sound system – Harman Kardon® Logic 7® with Dolby Digital 5.1 and DTS 14 high-performance speakers and total output of 830 watts | ○ | ● | ○ | ● |
| USB ports (2) in centre console | ● | ● | ● | ● |



| Item | AMG Line | designo Line | Mercedes-AMG GLE 43 | Mercedes-AMG GLE 63 S |
|--|----------|--------------|---------------------|-----------------------|
| Safety and Assistance Systems | | | | |
| Active Brake Assist The driver is given a visual warning if the distance from a vehicle in front is inadequate. On detecting the danger of a collision there is an acoustic warning, driver braking can be assisted and, if the driver fails to react, the speed can be reduced autonomously. Autonomous partial braking only occurs if the driver fails to react and is travelling at a speed range between 4–65 mph speeds for moving objects and 4–31 mph for stationary objects | ● | ● | ● | ● |
| Active bonnet – pedestrian safety measure | ● | ● | ● | – |
| Adaptive brake lights | ● | ● | ● | ● |
| Airbags – driver and front passenger | ● | ● | ● | ● |
| Airbags – driver’s kneebag | ● | ● | ● | ● |
| Airbags – front sidebags | ● | ● | ● | ● |
| Airbags – windowbags | ● | ● | ● | ● |
| Alarm system with immobiliser and interior protection (MBSS3) | ● | ● | ● | ● |
| AMG high-performance braking system with internally ventilated and perforated brake discs | – | – | – | ● |
| Anti-lock braking system (ABS) with Brake Assist (BAS) | ● | ● | ● | ● |
| ATTENTION ASSIST Continuously analyses driver behaviour and steering movements. If patterns are recognised which characterise drowsiness, the driver is prompted to take a break, and an audible warning is sounded. At the same time COMAND Online offers to locate a rest stop | ● | ● | ● | ● |



| Item | AMG Line | designo Line | Mercedes-AMG GLE 43 | Mercedes-AMG GLE 63 S |
|---|----------|--------------|---------------------|-----------------------|
| Safety and Assistance Systems (continued) | | | | |
| Automatic child seat recognition sensor When the front passenger seat is unoccupied or a child seat is detected, the front passenger airbag is automatically deactivated | ● | ● | ● | ● |
| Braking - adaptive Brake Assist with HOLD function and Hill Start Assist | ● | ● | ● | ● |
| Collapsible spare wheel Not available with optional Bang & Olufsen BeoSound AMG (code 811) - replaced by TIREFIT tyre sealant | - | - | - | ● |
| Crosswind Assist Detects sudden, strong gusts of wind and helps the driver stay in lane by means of targeted braking | ● | ● | ● | ● |
| Downhill Speed Regulation (DSR) with on/off switch and variable speed control | ● | ● | ● | ● |
| Electric parking brake | ● | ● | ● | ● |
| Electronic Stability Programme (ESP®) with Acceleration Skid Control (ASR) | ● | ● | ● | ● |
| First-aid kit and warning triangle | ● | ● | ● | ● |
| Four-wheel Electronic Traction System (4ETS) | ● | ● | ● | ● |

| Item | AMG Line | designo Line | Mercedes-AMG GLE 43 | Mercedes-AMG GLE 63 S |
|--|----------|--------------|---------------------|-----------------------|
| ISOFIX child seat attachment points in the rear (two outer seats) | ● | ● | ● | ● |
| Outside temperature display, rear seat belt status indicator | ● | ● | ● | ● |
| PRE-SAFE® anticipatory safety system with reversible belt tensioners for driver and front passenger seats, closing function for side windows | ● | ● | ● | ● |
| Remote central locking | ● | ● | ● | ● |
| Service indicator ASSYST | ● | ● | ● | ● |
| Traffic Sign Assist Speed Limit Assist with wrong-way warning function and display of speed limit in instrument cluster | ● | ● | ● | ● |
| Tyre pressure monitoring system | ● | ● | ● | ● |

A revolution in style

| Item | Notes | | AMG Line | designo Line | Mercedes-AMG GLE 43 | Mercedes-AMG GLE 63 S | Basic RRP excl. VAT (£) | Total RRP incl. VAT (£) |
|---|-------|---|----------|--------------|---------------------|-----------------------|----------------------------|----------------------------|
| Wheels | | | | | | | | |
| 21" AMG alloy wheels (4) – 5-twin-spoke design, painted titanium grey with high-shine finish front: 275/45 tyres rear: 315/40 tyres | |  | 650 | ● | ● | - | - | - |
| 21" AMG bi-colour alloy wheels (4) – 5-twin-spoke design front: 275/45 tyres rear: 315/40 tyres | |  | 684 | ○ | ○ | ● | - | Included in Night package |
| 22" AMG bi-colour alloy wheels (4) – 5-twin-spoke design front: 285/40 tyres rear: 325/35 tyres | |  | 671 | - | - | ○ | - | Included in Sports package |

● Standard ○ Optional - Not available



> View offers



Book a > test drive > AMG test drive



> Find a Retailer



> View the Range Guide

| Item | Notes |  | 676 | - | - | - | ● | Basic RRP excl. VAT (£) | Total RRP incl. VAT (£) |
|--|-------|---|-----|---|---|---|---|----------------------------|----------------------------|
| Wheels (continued) | | | | | | | | | |
| 22" AMG alloy wheels (4) – multi-spoke design, painted titanium grey with high-shine finish front: 285/40 tyres rear: 325/35 tyres | | | | | | | | - | - |
| 22" AMG alloy wheels (4) – multi-spoke design, matt black front: 285/40 tyres rear: 325/35 tyres | | | 680 | - | - | - | ○ | Included in Night package | |

● Standard ○ Optional - Not available

Driving Assistance Plus package

This comprehensive package includes many advanced features to help keep you safe on the road: Active Blind Spot Assist monitors the obscure area to the side and rear. The innovative driver assistance system DISTRONIC PLUS cruise control helps to automatically maintain a safe distance from the vehicle ahead. Active Lane Keeping Assist is able to recognise when the vehicle is unintentionally drifting out of its lane, and duly warns the driver with pulsed vibrations on the steering wheel. Plus the renowned

PRE-SAFE® safety system can detect critical road situations and initiate preventive safety measures.

Driving Assistance Plus package (code 23P) – designed and priced as a package, including items as listed below.

All models

Total incl. VAT £1,695.00

| Item | Notes |
|--|--|
| Active Blind Spot Assist | Displays a red triangle in the exterior mirrors: when a road user is detected in the blind spot, the red triangle flashes and an audible warning sounds if the driver operates the indicators. Includes course-correcting braking intervention |
| Active Brake Assistant with cross-traffic function | Active Brake Assistant can lower the risk of rear-end collisions and support the driver during emergency braking by providing additional brake pressure |
| Active Lane Keeping Assist | Detects signs of inadvertent drifting out of lane and warns the driver by vibrating the steering wheel and, if necessary, will trigger one-sided braking intervention |
| Distance Pilot DISTRONIC with Steering Pilot | Helps the driver maintain the desired distance to the vehicle in front, and helps with lane guidance |
| PRE-SAFE® PLUS | If a rear impact is imminent, this addition to the PRE-SAFE® system can initiate preventive occupant protection measures. These include warning the traffic following behind and locking the vehicle brakes when at a standstill if the driver indicates that he wishes to remain stationary |

Night package

GLE 350 d 4MATIC



Mercedes-AMG GLE 63 S 4MATIC



The Night package contains striking exterior features increasing the visual appeal of the GLE Coupé. The package features 21" or 22" AMG alloy wheels, AMG bodystyling in high-gloss black as well as high-gloss exterior trim elements.

Night package – designed and priced as a package, including items as listed below.

GLE 350 d 4MATIC **Total incl. VAT £495.00**
Mercedes-AMG GLE 63 S 4MATIC **£895.00**

| Item | Night package ¹ £495.00 ³ (code P55) | Night package ² £895.00 ³ (code P55) |
|--|--|--|
| Includes a black radiator grille, black front and rear underguards, black exterior mirrors, black beltline and shoulderline trim strips, black rear trim parts | ■ | ■ |
| 21" AMG bi-colour alloy wheels (4) - 5-twin-spoke design (code 684) | ■ | - |
| 22" AMG alloy wheels (4) - 5-twin-spoke design, painted in matt black (code 680) | - | ■ |

■ Included - Not included ¹Available on GLE 350 d 4MATIC only ²Available on Mercedes-AMG GLE 63 S 4MATIC only ³Including VAT Please note that red brake calipers are standard equipment on Mercedes-AMG GLE 63 S 4MATIC only



Sports package



The active suspension stabilisers of the ACTIVE CURVE SYSTEM help reduce the rolling tendency and provides markedly enhanced driving comfort. The system actively influences the stabiliser bars during cornering to keep the torsion moment constant, which allows the vehicle to adapt to every situation. In off-road terrain, the system ensures improved axle articulation by decoupling the two stabiliser bars on the front and rear axles. 22" AMG alloy wheels in gloss black also form part of this package.

Sports package – designed and priced as a package, including items as listed below.

Mercedes-AMG GLE 43 4MATIC

Total incl. VAT £3,495.00

Sports package (code DP8)

22" AMG gloss black alloy wheels (code 671)

ACTIVE CURVE SYSTEM with roll stabilisation





Optional equipment

| Item | Notes | AMG Line | designo Line | Mercedes-AMG GLE 43 | Mercedes-AMG GLE 63 S | Basic RRP excl. VAT (£) | Total RRP incl. VAT (£) |
|--|--|----------|--------------|---------------------|-----------------------|----------------------------|----------------------------|
| AMG Performance Studio | | | | | | | |
| AMG Performance package AMG Driver's package – including an increase in restriction of top speed to 175 mph and participation in driver training at the AMG Driving Academy. AMG Performance exhaust system: from emotional to restrained, the sound of the AMG sports exhaust system adapts to the transmission mode selected by the driver by means of variably adjustable exhaust flaps | | 250 | - | - | - | 955.83 | 1,195.00 |
| AMG carbon fibre engine cover | | B14 | - | - | - | 1,245.83 | 1,495.00 |
| Exterior | | | | | | | |
| Lane Tracking package Blind Spot Assist Lane Keeping Assist | | 22P | ○ | ○ | ○ | 495.83 | 595.00 |
| Tow bar – fully electric Includes 13-pin socket | When ordering, please discuss with your Retailer any specific electrical towing requirements | 550 | ○ | ○ | ○ | 791.67 | 950.00 |
| Paint, Trim and Upholstery | | | | | | | |
| Paint – designo diamond white bright | | 799 | ○ | ○ | ○ | 704.17 | 845.00 |
| Paint – designo hyacinth red bright | | 996 | ○ | ○ | ○ | 704.17 | 845.00 |
| Roof lining – black fabric | Please check with your Retailer for availability | 51U | ○ | - | ○ | 83.33 | 100.00 |

| Item | Notes | | AMG Line | designo Line | Mercedes-AMG GLE 43 | Mercedes-AMG GLE 63 S | Basic RRP excl. VAT (£) | Total RRP incl. VAT (£) |
|---|-------|------|----------|--------------|---------------------|-----------------------|----------------------------|----------------------------|
| Paint, Trim and Upholstery (continued) | | | | | | | | |
| Trim – AMG carbon fibre/black piano lacquer | | H10 | ○ | - | ○ | ○ | 1,245.83 | 1,495.00 |
| | | | - | ○ | - | - | 916.66 | 1,100.00 |
| Trim – black high-gloss poplar wood | | 729 | ○ | ● | ○ | ○ | 329.17 | 395.00 |
| Trim – brown open-pore ash wood trim | | H09 | ○ | - | ○ | ○ | 329.17 | 395.00 |
| | | | - | ○ | - | - | no-cost option | |
| Trim – designo black piano lacquer | | H21 | ○ | - | ○ | ○ | 329.17 | 395.00 |
| | | | - | ○ | - | - | no-cost option | |
| Trim – dark brown high-gloss eucalyptus wood | | 734 | ○ | - | ○ | ○ | 329.17 | 395.00 |
| | | | - | ○ | - | - | no-cost option | |
| Upholstery – pearl black/black nappa leather with red stitching | | 821A | ○ | - | ○ | - | no-cost option | |
| Upholstery – porcelain/black nappa leather | | 855A | ○ | - | ○ | - | no-cost option | |
| Upholstery – porcelain/black Exclusive nappa leather | | 535A | - | - | - | ○ | no-cost option | |
| Upholstery – espresso brown/black Exclusive nappa leather | | 534A | - | - | - | ○ | no-cost option | |

| Item | Notes | AMG Line | designo Line | Mercedes-AMG GLE 43 | Mercedes-AMG GLE 63 S | Basic RRP excl. VAT (£) | Total RRP incl. VAT (£) |
|--|--|----------|--------------|---------------------|-----------------------|----------------------------|----------------------------|
| Communications and In-Car Entertainment | | | | | | | |
| Bang & Olufsen BeoSound AMG sound system with 14 high-performance speakers and a total output of 1,200 watts | For GLE 350 d AMG Line and Mercedes-AMG GLE 43 4MATIC only available with Premium Plus equipment line (code DP1). The collapsible spare wheel is replaced by TIREFIT | 811 | ○ | ○ | ○ | 2,912.50 | 3,495.00 |
| Rear Seat Entertainment System DVD player Remote control Two 8-inch displays integrated into the front seat head restraints Two sets of Kleer wireless headphones | | 864 | ○ | ○ | ○ | 1,600.00 | 1,920.00 |
| Universal Telephony package in armrest with universal interface for universal cradle, extended telephone functionality, charging function and LTE-compatible exterior aerial for optimum reception. Smartphones can be conveniently connected to the onboard hands-free system via a universal interface in the armrest. For this, the smartphone is simply inserted into the universal smartphone cradle. This can be connected to the interface with a click within seconds. The use of the LTE-compatible exterior aerial ensures optimum reception and transmission. In addition the battery can be charged. The smartphone is conveniently operated using the onboard system. Access to the phone's internal memory is also possible in this way | | 386 | ○ | ○ | ○ | 291.67 | 350.00 |

| Item | Notes | AMG Line | designo Line | Mercedes-AMG GLE 43 | Mercedes-AMG GLE 63 S | Basic RRP excl. VAT (£) | Total RRP incl. VAT (£) | |
|---|---|----------|--------------|---------------------|-----------------------|----------------------------|----------------------------|--------------|
| Service Package | | | | | | | | |
| <p>Service Care</p> <p>Service Care allows you to spread the cost of servicing your new car in the Mercedes-Benz Retailer network. Taking out a Service Care plan ensures your servicing needs are taken care of by fully trained Mercedes-Benz Technicians with the added benefit of a Mercedes-Benz service history</p> | <p>Price is based on a monthly rate. Example given is for two services taken over 24 months or three services over 36 months. Further payment options are available. New Service Care prices apply only to vehicles up to 12 months old prior to first service. Prices correct at the time of publication</p> | 1 | ○ | ○ | ○ | - | 32.50 | 39.00 |
| | | - | - | - | ○ | 37.50 | 45.00 | |

Genuine Accessories

We've developed a range of Accessories you can add to help personalise and enhance your GLE Coupé. Your local Mercedes-Benz Retailer can advise on fitting costs of Accessories, where applicable. Further information on our full range of Genuine Accessories can be found on the Mercedes-Benz UK website.

01 | LED Mercedes star projector

The legendary three-pointed star logo is discreetly projected onto the ground alongside your vehicle every time you open the front driver or passenger door. The star automatically disappears once the doors are closed. Not in conjunction with Mirror package.

RRP £120.00 (incl. VAT), excluding fitting



02 | Door handle recess

An exclusive highlight: the refined, chrome-design door handle recesses lend the vehicle a polished, individual look. The stable, robust material is precision-tailored to the bodywork and protects the paintwork in the recess from scratches. Set of 2.

RRP £40.68 (incl. VAT), excluding fitting





> View offers



Book a > test drive > AMG test drive



> Find a Retailer



> View the Range Guide

03 | Floor mat trays

Made from robust, washable synthetic material for heavy use. Covers the entire footwell. The raised edges and structured surface help keep the floor clean and dry. With distinctive 'Mercedes-Benz' lettering.

RRP £159.50 (incl. VAT)



04 | Concertina load sill protector

Foldable protective mat. Easy to attach. Protects bumper and load sill from scratches. Helps keep the load area clean. Helps protect clothing when loading boot/load compartment or roof box. Can be connected to boot tub and reversible mat. Space-saving stowage. Easy to clean.

RRP £41.53 (incl. VAT)



05 | Shallow boot tub

The boot tub is suitable for transporting shopping. The tub shape with its slightly raised edge is precision-tailored to the load area. Made from impact-resistant, non-slip polypropylene. Cannot be used in conjunction with third row of seats or hybrid vehicles.

RRP £105.36 (incl. VAT)



06 | Apple iPad[®]2[®]-iPad4[®] Dock

The ergonomic, crashproof Docking Station introduces the iPad[®] and all of its familiar functions to your Mercedes-Benz. All connections, e.g. for your headphones or charging cable, remain accessible. The mount is fitted to the head restraint and can be tilted and rotated around 90°. Available for iPad[®], iPad[®] 2, iPad[®] 3 and iPad[®] 4.

RRP £227.50 (incl. VAT)



07 | Head restraint modular system

Carefree travel with Mercedes-Benz Style & Travel Equipment. The head restraint elements are simple to fit and remove. The modular system centres around a base support which can be combined with a coat hanger, universal hook, folding table and tablet mount.

Base support: RRP £22.32 (incl. VAT)

Coat hanger: RRP £67.60 (incl. VAT)

Folding table: RRP £102.60 (incl. VAT)

Universal hook: RRP £26.76 (incl. VAT)





08 | Alustyle Easy-Fix II basic carrier bars for roof rails

Aluminium carrier bars, precision-tailored to the body of your Mercedes-Benz – the perfect basis for a range of Mercedes-Benz transport solutions: ski and snowboard rack, bicycle rack or roof boxes.

RRP £479.89 (incl. VAT)

09 | Mercedes-Benz roof boxes

An aerodynamic design, tailored to your Mercedes-Benz. In extremely durable material. Designed for quick, optimised attachment to the basic carrier bars. Particularly convenient loading and unloading thanks to the option of double-sided opening. Lockable from both sides. Available in various sizes.

RRP from £361.64 (incl. VAT)

10 | Alustyle bicycle rack

Extremely lightweight bicycle rack, designed to allow you to attach a bicycle to the basic carrier bars for roof rails. Bicycles can either be attached to the rack once it has been fitted to the roof or, conveniently, before it is fitted. The support frame can also be folded down when not in use to reduce drag when travelling without cycles.

RRP £121.00 (incl. VAT)



Colours and materials

Non-metallic paint

Standard



149 polar white

Metallic paints

Standard



197 obsidian black



896 brilliant blue



775 iridium silver



988 diamond silver



796 citrine brown



992 selenite grey



890 cavansite blue

Special metallic paints

Additional-cost option

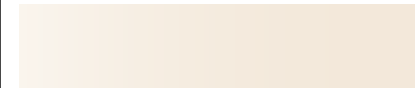

799 designo diamond white bright



996 designo hyacinth red bright

AMG Line upholstery

Nappa leather (standard)



811A pearl black/black

Optional



821A pearl black/black with red stitching



855A porcelain/black

AMG Line trim

Standard



739 brushed light aluminium

Optional



729 black high-gloss poplar wood¹



734 dark brown high-gloss eucalyptus wood¹



H09 brown open-pore ash wood¹



H10 AMG carbon fibre/black piano lacquer¹



H21 designo black piano lacquer¹

designo Line upholstery

designo Exclusive Nappa leather (standard)



955A porcelain/black

designo Line trim

Standard



729 black high-gloss poplar wood

Optional



734 dark brown high-gloss eucalyptus wood



H09 brown open-pore ash wood



H10 AMG carbon fibre/black piano lacquer¹



H21 designo black piano lacquer

Mercedes-AMG GLE 43 4MATIC upholstery

Nappa leather (standard)



811A pearl black/black

Optional



821A pearl black/black with red stitching



855A porcelain/black

Mercedes-AMG GLE43 4MATIC trim

Standard



739 brushed light aluminium

Optional



729 black high-gloss poplar wood¹



734 dark brown high-gloss eucalyptus wood¹



H09 brown open-pore ash wood¹



H10 AMG carbon fibre/black piano lacquer¹



H21 designo black piano lacquer¹

¹Additional-cost option

Mercedes-AMG GLE 63 S 4MATIC upholstery

AMG Exclusive nappa leather

Standard



541A black with grey stitching

Optional



534A espresso brown/black



535A porcelain/black

Mercedes-AMG GLE 63 S 4MATIC trim

Standard



739 brushed light aluminium

Optional



729 black high-gloss
poplar wood¹



734 dark brown high-gloss
eucalyptus wood¹

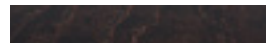

H09 brown open-pore
ash wood¹



H10 AMG carbon fibre/black
piano lacquer¹



H21 designo black piano lacquer¹





¹Additional-cost option

Trim and upholstery combinations

| | AMG Line | | | designo Line | Mercedes-AMG GLE 63 S 4MATIC | | |
|-----------------------------|-----------------------------------|---|--------------------------------|---------------------------------|------------------------------|--------------------------------|-----------------------------------|
| | Nappa leather | | | designo Exclusive nappa leather | AMG Exclusive nappa leather | | |
| | pearl black/black (811A) | pearl black/black with red stitching (821A) | porcelain/black (855A) | porcelain/black (955A) | espresso brown/black (534A) | porcelain/black (535A) | black with grey stitching (541A) |
| Dashboard | | | | | | | |
| Steering wheel | black | black | black | black | black | black | black |
| Upper dashboard trim | black | black | black | black | black | black | black |
| Lower dashboard trim | black | black | black | black | black | black | black |
| Seats | | | | | | | |
| Seat cushion centre section | black | black | porcelain | porcelain | espresso brown | porcelain | black |
| Side bolster trim | black | black | black | porcelain | espresso brown | porcelain | black |
| Head restraint | black | black | black | porcelain | espresso brown | porcelain | black |
| Seat belt | black | black | black | black | black | black | crystal grey |
| Topstitching | grey | red | porcelain | porcelain/black | grey | black | grey |
| Doors | | | | | | | |
| Door trim at beltline | black | black | black | black | black | black | black |
| Door centre panel | black | black | porcelain | porcelain | espresso brown | porcelain | black |
| Roof lining | crystal grey (black) ² | crystal grey (black) ² | porcelain (black) ² | black ¹ | black | porcelain (black) ² | crystal grey (black) ² |
| Floor covering | | | | | | | |
| Front and rear | black | black | black | black | black | black | black |
| Boot | black | black | black | black | black | black | black |

¹DINAMICA microfibre ²Optional

Combination options

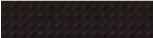
| | Non-metallic paint Standard | 149 polar white | Metallic paints Standard | 197 obsidian black | 775 iridium silver | 796 citrine brown | 890 cavansite blue | 896 brilliant blue | 988 diamond silver | 992 selenite grey | Special metallic paints Additional-cost option | 799 designo diamond white bright | 996 designo hyacinth red bright |
|---|--------------------------------|-----------------|-----------------------------|--------------------|--------------------|-------------------|--------------------|--------------------|--------------------|-------------------|---|----------------------------------|---------------------------------|
| Nappa leather AMG Line (standard) | | | | | | | | | | | | | |
|  pearl black/black | ● | | ● | ● | ● | ○ | ● | ● | ● | | ● | ● | |
| pearl black/black with red stitching | ● | | ● | ● | ● | ○ | ● | ● | ● | | ● | ● | |
|  porcelain/black | ● | | ● | ● | ● | ● | ● | ● | ● | | ● | ● | |
| designo Exclusive nappa leather designo Line (standard) | | | | | | | | | | | | | |
|  porcelain/black | ● | | ● | ● | ● | ● | ● | ● | ● | | ● | ● | |
| AMG Exclusive nappa leather Mercedes-AMG GLE 63 S 4MATIC (standard) | | | | | | | | | | | | | |
|  black with grey stitching | ● | | ● | ● | ● | ● | ● | ● | ● | | ● | ● | |
|  porcelain/black | ● | | ● | ● | ● | ● | ● | ● | ● | | ● | ● | |
|  espresso brown/black | ● | | ● | ● | △ | ○ | ● | ● | ● | | ● | △ | |

● Recommended ○ Possible △ Not recommended - Not available Please note that, owing to limitations of on-screen representation, paint colours may differ from those shown

Technical data

| | Diesel engine | Petrol engines | |
|--------------|------------------|---------------------|------------------------------|
| Model | GLE 350 d 4MATIC | Mercedes-AMG GLE 43 | Mercedes-AMG GLE 63 S 4MATIC |

| Engine | | | | |
|------------------------------|----------------|-----------------|-----------------------|-----------------|
| Total displacement | cc | 2,987 | 2,996 | 5,461 |
| Arrangement/cylinders/valves | | V/6/24 | V/6/24 | V/8/32 |
| Power ¹ | hp (kW) at rpm | 258 (190)/3,400 | 390 (287)/5,500-6,000 | 585 (430)/5,500 |
| Torque ¹ | Nm at rpm | 620/1,600-2,400 | 520/1,800-4,000 | 760/1,750-5,250 |

| Transmission | | | | |
|---|--|---|---|---|
| 9G-TRONIC PLUS 9-speed automatic | | ● | ● | - |
| AMG SPEEDSHIFT PLUS 7G-TRONIC 7-speed auto. | | - | - | ● |

| Tyre sizes | | | | |
|-------------------|--|--------|--------|--------|
| Front | | 275/45 | 275/45 | 285/40 |
| Rear | | 315/40 | 315/40 | 325/35 |

| Performance | | | | |
|-----------------------|-----|-----|-----|------------------|
| Acceleration 0-62 mph | sec | 7.0 | 5.7 | 4.2 |
| Top speed | mph | 140 | 155 | 155 ² |



| Model | Diesel engine | | Petrol engines | |
|-------|---------------|------------------|---------------------|------------------------------|
| | | GLE 350 d 4MATIC | Mercedes-AMG GLE 43 | Mercedes-AMG GLE 63 S 4MATIC |

Weights and capacities

| | | | | |
|--------------------------------------|----|--------------|--------------|--------------|
| Kerb weight ³ | kg | 2,260 | 2,240 | 2,350 |
| Perm. Gross Vehicle Weight | kg | 2,900 | 2,880 | 3,050 |
| Towing capacity – unbraked braked | kg | 750 2,900 | 750 3,500 | 750 3,500 |
| Boot capacity | l | 650 | 650 | 650 |
| Fuel tank capacity/of which reserve | l | 93/12 | 93/12 | 93/14 |
| Turning circle kerb to kerb | m | 11.8 | 11.8 | 11.8 |
| Wading depth | mm | 500 | 500 | 500 |

Fuel consumption^{4,5}

mpg

| | | | |
|--------------------------|------|------|------|
| Urban | 35.8 | 23.7 | 17.9 |
| Extra-urban ⁶ | 42.8 | 35.3 | 29.1 |
| Combined | 39.2 | 30.0 | 23.7 |

| | Diesel engine | Petrol engines | |
|--------------|------------------|---------------------|------------------------------|
| Model | GLE 350 d 4MATIC | Mercedes-AMG GLE 43 | Mercedes-AMG GLE 63 S 4MATIC |

| CO ₂ emissions ⁵ | g/km | | |
|--|------|-----|-----|
| Emissions standard | EU6 | EU6 | EU6 |
| 21" alloy wheels | 187 | 215 | - |
| 22" alloy wheels | - | 225 | 278 |

Insurance

| | | | |
|--------------|-------|----|----|
| Group rating | 45-46 | 48 | 50 |
|--------------|-------|----|----|

Insurance ratings may vary depending on model specification. Please refer to <http://www.thatcham.org/abigrouprating/> for further details

¹Figures according to Directive 80/1269/EEC in the currently applicable version

²Electronically limited

³Figures according to Directive 92/21/EC (kerb weight with fuel tank 90% full, driver, 68 kg, and luggage, 7 kg) for standard-specification vehicles

⁴All figures are based on a standard specification with the smallest tyre size

⁵The choice of wheels and transmission may affect CO₂ emissions and corresponding Road Fund Licence

⁶EUDC: extra-urban driving cycle. Testing procedures adhere to EU Directive 93/116

The figures on pages 55-58 are correct at time of publication. Please refer to the government website for latest data - <http://carfueldata.direct.gov.uk/>

All measurements in millimetres. The dimensions shown are mean values and apply to standard-specification, unladen vehicles



> View offers



Book a > test drive > AMG test drive



> Find a Retailer



> View the Range Guide

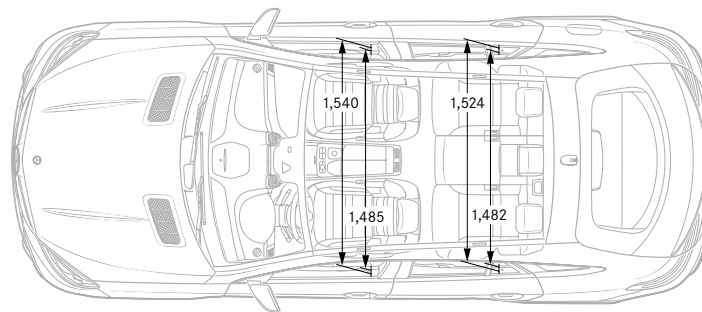
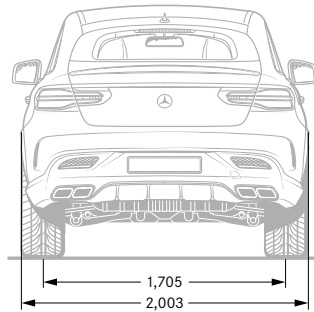
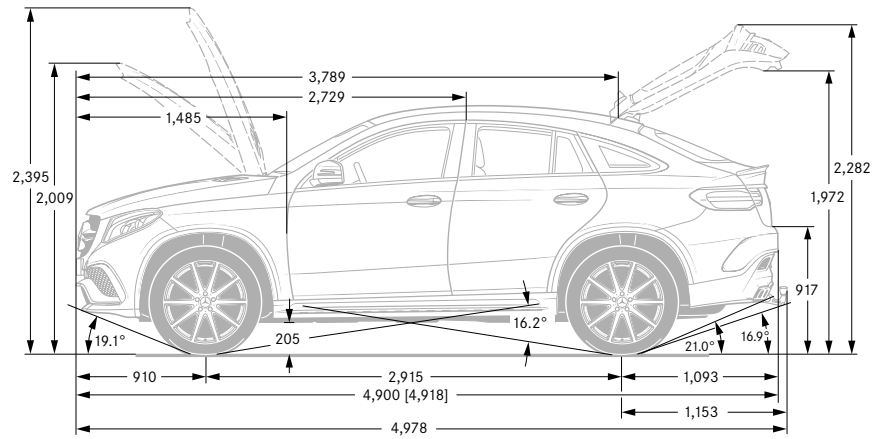
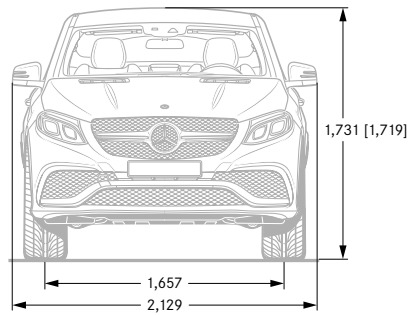

Figures in square brackets relate to Mercedes-AMG GLE 63 S 4MATIC



Road Fund Licence



All road vehicle registrations are subject to Vehicle Excise Duty (Road Fund Licence), which varies in accordance with the vehicle's CO₂ emissions. A first year rate for each taxation band will apply. The table below shows the bands (A–M) created by the DVLA and the corresponding Road Fund Licence. CO₂ emissions are listed in the technical data on page 57, and the relevant Excise Duty is reflected in the on-the-road prices on page 10.

| Band | CO ₂ emissions | First year rate (£) | Standard rate (£) | Premium rate (£) ¹ |
|------|---------------------------|---------------------|-------------------|-------------------------------|
| A | 0 g/km | 0.00 | 0.00 | 310.00 |
| B | 1 to 50 g/km | 10.00 | 140.00 | 450.00 |
| C | 51 to 75 g/km | 25.00 | 140.00 | 450.00 |
| D | 76 to 90 g/km | 100.00 | 140.00 | 450.00 |
| E | 91 to 100 g/km | 120.00 | 140.00 | 450.00 |
| F | 101 to 110 g/km | 140.00 | 140.00 | 450.00 |
| G | 111 to 130 g/km | 160.00 | 140.00 | 450.00 |
| H | 131 to 150 g/km | 200.00 | 140.00 | 450.00 |
| I | 151 to 170 g/km | 500.00 | 140.00 | 450.00 |
| J | 171 to 190 g/km | 800.00 | 140.00 | 450.00 |
| K | 191 to 225 g/km | 1,200.00 | 140.00 | 450.00 |
| L | 226 to 255 g/km | 1,700.00 | 140.00 | 450.00 |
| M | over 255 g/km | 2,000.00 | 140.00 | 450.00 |

Some of the model features, optional extras and colours shown may not be available or may only be available in a different specification.

¹Premium rate only applicable to vehicles where the list price is over £40,000 including any factory-fitted options, standard UK delivery charge, number plates, fuel and VAT

Services and insurance

Mercedes-Benz Service Care

We believe that servicing costs should be as flexible and affordable as possible for your GLE Coupé, which is why we offer Service Care, an easy way to budget for all your servicing costs. It spreads your bills into manageable payments based on whether you have a new or used Mercedes-Benz.

With Service Care we guarantee the price of parts and labour for up to three services and safeguard against any further inflation. It also covers the cost of all recommended service items including brake fluid, spark plugs, air filters, fuel filters and screen wash.

You can choose either to add your servicing costs into your monthly spend or pay the full amount in a one-off payment, giving you peace of mind that they are taken care of for the period of the plan.

To receive a personalised Service Care plan recommendation visit the Service Care Calculator at servicecarerates.mercedes-benz.co.uk

Warranty and breakdown cover

Every Mercedes-Benz comes with a three-year unlimited mileage warranty against manufacturing or material defects¹ and up to 30 years warranty against perforation due to corrosion from the inside out.² What's more, it's also covered by Mercedes-Benz Roadside Assistance – a unique package comprising up to 30 years pan-European breakdown assistance.²

Insurance

Since our name is synonymous with reliability, who better to trust with your motor insurance? Mercedes-Benz Insurance provides a motor insurance policy specifically designed to give you the cover you would expect from Mercedes-Benz. For a motor insurance quotation, call **0345 600 2180**.*



> View offers



Book a > test drive > AMG test drive



> Find a Retailer



> View the Range Guide

Mercedes me connect

Mercedes me connect enables you to connect to your car via desktop, tablet or smartphone via an app. It provides access to services that enhance your Mercedes-Benz experience and fit effortlessly into your daily digital routine.¹

Standard Services.

Available on all models, except G-Class.

- **Emergency Call** – if there's an accident, this feature automatically shares your vehicle location and status for a fast response from the emergency services
- **Accident & Breakdown Management** – contact our Customer Assistance Centre with a single button for fast breakdown recovery
- **Telediagnosics** – automatically detects and shares details of any vehicle wear and tear with you, and shares the data with your Retailer
- **Maintenance Management** – reminds you when your service is due and automatically shares maintenance data with your Retailer
- **Parking Time Assist** – track the time on your parking meter and receive an alert when it's due to expire



Vehicle Setup.

These services come as standard if you have COMAND Online. Available as an optional £69 upgrade for all other customers.

- **Personal Profile** – store your preferences, such as your favourite radio stations and apps, to create your personal driver profile
- **Maintenance (Vehicle Status)** – check safety information, such as coolant level and brake pad condition, so you can be sure your car is safe and ready to drive
- **Remote Door Unlock** – lock and unlock your car remotely, wherever you are in the world
- **Send to Car Function** – search for destinations on your smartphone, tablet or desktop, then send the routes direct to your car for navigation

¹Currently unavailable in the Channel Islands and the Isle of Man



> View offers



Book a > test drive > AMG test drive



> Find a Retailer



> View the Range Guide

Mercedes me connect

62

Remote Online Services.

Standard on all models with COMAND Online, except for new E-Class. Available to purchase for an additional £150.00 (incl. VAT) for all models without COMAND Online.

- **Trip information and vehicle status** – access the vehicle's trip data such as fuel level, mileage, condition of brake pads and tyre pressure
- **Remote door locking and unlocking** – lock and unlock your car remotely, wherever you are in the world
- **Geofencing** – set up a geographical boundary and receive alerts whenever your car enters or leaves this area
- **Parked Vehicle Locator** – locate your parked vehicle within a range of one mile and plot a route back to it
- **Vehicle Tracker** – track the location of your car anywhere in the world

Additional services for Plug-In Hybrid and electric models only, as part of Remote Online services:

- **Pre-entry climate control** – activate the pre-entry climate control system of your parked vehicle and set the temperature to your liking before boarding
- **Route planning** – displays the electric operating range on a map and enables you to plan a route while stopping at public charging stations
- **Charging points** – displays a list of the nearest public charging stations
- **Charging profile** – control the charging settings from a distance so your vehicle can be ready charged when you need it

Vehicle Monitoring.

Standard with COMAND Online for all models, except the new E-Class. Available to purchase for new E-Class and all other customers as an additional £69 upgrade.

- **Geo-fencing** – set up a geographical boundary and receive alerts whenever your car enters or leaves this area
- **Parked Vehicle Locator** – locate your parked car when within 1 mile and plot a route back to it
- **Vehicle Tracker** – track the location of your car anywhere in the world

Visit the Mercedes me connect store for more information:

shop.mercedes-benz.com/en-gb/connect

Mercedes **me**



Mercedes-Benz Finance

Why should you finance with Mercedes-Benz?

At Mercedes-Benz we believe a great driving experience should be matched by an equally great ownership experience. That is why we put just as much thought, time and effort into designing our finance options, our service plans and our insurance cover as we do into our vehicles.

We are not in the business of simply providing a loan to fund the purchase of your dream vehicle. We look on it as a journey that we take with you, from the moment you choose your new Mercedes-Benz, to helping you in choosing your next one.

If you would like to find out more about any of our current offers, simply call into your local Mercedes-Benz Retailer where one of our Business Managers will be more than happy to talk you through anything you need to know.

Helping you find the right solution.

You should find our finance packages are more convenient than a traditional personal loan because:

- Funds are immediately available – no waiting for cheques or loans to clear.
- There is no security required – either against your home or other assets.
- We have clear and transparent rates – the APR we quote is the APR you get.
- We have friendly Business Managers – experts in vehicle finance who can talk you through all of your plans in detail.

One of our most popular finance products is Mercedes-Benz Agility (our Personal Contract Purchase product). We also offer Contract Hire, Operating Lease and Hire Purchase solutions. If you would like to find out more about these speak to your Retailer or visit www.mercedes-benz.co.uk/fandi.

Mercedes-Benz Agility (our PCP product).

At the start of an Agility agreement, you put down a deposit and decide the term of your agreement and your annual mileage. You will be advised of the Guaranteed Future Value, which offers you the reassurance of knowing exactly what you will need to pay to own the vehicle outright in the future (this is known as the Optional Purchase Payment).

Throughout your agreement you simply pay your agreed monthly payments and when the agreement comes to an end you either purchase, hand back or part-exchange your vehicle.



Agility features:

- Fixed regular payments mean you can easily budget.
- Payments are based only on a proportion of the vehicle's value, keeping your monthly payments lower.
- Our Guaranteed Future Value avoids the risk of unplanned depreciation of your vehicle.
- You defer your ownership decision until the end of the agreement.

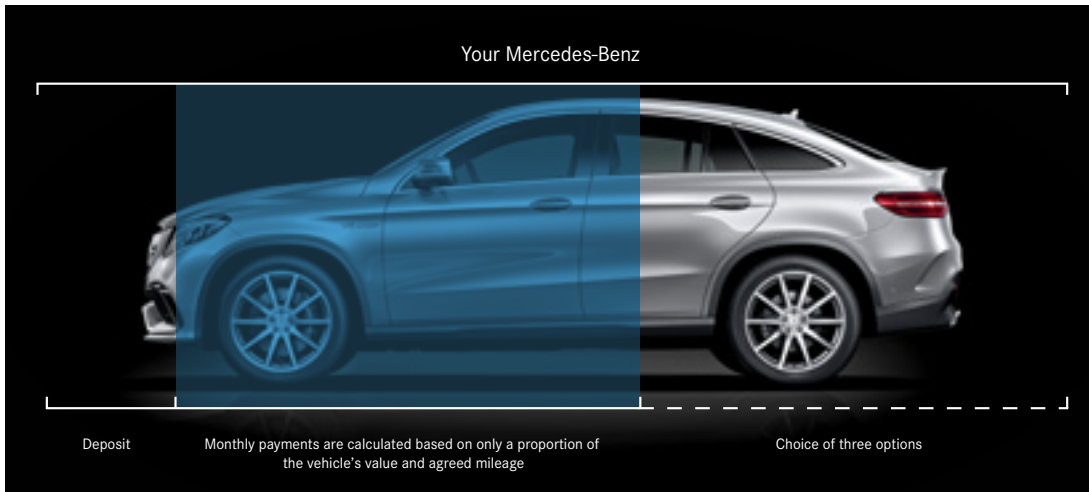

At the end of your agreement you have three options to choose from.

Option 1: Purchase your Mercedes-Benz.

Purchase your Mercedes-Benz by paying the Optional Purchase Payment and Purchase Activation Fee.¹ This will complete the purchase of your Mercedes-Benz, leaving you free to simply enjoy your vehicle.

Option 2: Hand back your Mercedes-Benz.

If you decide to return your vehicle to us, it must be in line with our Vehicle Return Standards,^{*} as vehicle condition, excess mileage and other charges may be payable.

Option 3: Part-Exchange for a new vehicle.

Purchase your Mercedes-Benz by paying the Optional Purchase Payment and Purchase Activation Fee.¹ This will complete the purchase of your Mercedes-Benz, leaving you free to part-exchange for a new vehicle.

¹Please note the 'Purchase Activation Fee' of £10 will be debited from your account *To find out more information about our Vehicle Return Standards please visit <http://mercedes-benz.co.uk/vrs>

 [View offers](#)

 [Book a test drive](#) [AMG test drive](#)

 [Find a Retailer](#)

 [View the Range Guide](#)

Follow us on the following social media channels:

 facebook.com/mercedesbenzuk

 twitter.com/mercedesbenzuk

 youtube.com/mercedesbenzuk

 instagram.com/mercedesbenzuk

Effective from 11 July 2017 Production. Information correct at time of publication.

Prices and specifications are subject to change without prior notice.

MBC292PL/0717

Mercedes-Benz Cars UK Limited, Tongwell, Milton Keynes, MK15 8BA. Company number 2448457 www.mercedes-benz.co.uk