



[View offers](#)



[Book a test drive](#) [AMG test drive](#)



[Find a Retailer](#)



[View the Range Guide](#)

# GLS



Effective from 21 June 2017 Production.

Mercedes-Benz





> View offers



Book a > test drive > AMG test drive



> Find a Retailer



> View the Range Guide

# Contents

Model prices	14	Seating	36	Colours and materials	50
Finance offers	15	Night package	38	Technical data	54
AMG Line and designo Line	19	Driving Assistance package	39	Load space dimensions	58
Mercedes-AMG GLS 63 4MATIC	23	Entertainment package	40	Road Fund Licence	59
Mercedes-AMG driver training	25	Off-Road package	41	Services and insurance	60
Standard equipment	27	Optional equipment	42	Mercedes me	61
Wheels	34	Genuine Accessories	45	Mercedes-Benz Finance	63



> View offers



Book a > test drive > AMG test drive



> Find a Retailer



> View the Range Guide

## The hard facts to melt your heart

At Mercedes-Benz we appreciate the importance of detail. Over the following pages you'll find model prices and a breakdown of standard and optional equipment, as well as details of the comprehensive services and benefits that are available to every Mercedes-Benz driver.

See Mercedes-Benz in a new light. Now is the time to get yourself behind the wheel of a GLS. Choose from a number of attractive finance offers. Please see pages 15-18 for further details, or visit [www.mercedes-benz.co.uk/offers](http://www.mercedes-benz.co.uk/offers)

Of course, some things have to be experienced to be truly appreciated, such as the qualities that set a Mercedes-Benz apart. Which is why we'd like to invite you for a test drive at your local Mercedes-Benz Retailer. Alternatively, you can make arrangements by visiting [www.mercedes-benz.co.uk/testdrive](http://www.mercedes-benz.co.uk/testdrive)

For more information visit [www.mercedes-benz.co.uk](http://www.mercedes-benz.co.uk) or call 0333 222 0500.



[View offers](#)



[Book a test drive](#) [AMG test drive](#)



[Find a Retailer](#)



[View the Range Guide](#)





[View offers](#)



[Book a test drive](#) [AMG test drive](#)



[Find a Retailer](#)



[View the Range Guide](#)





> View offers



Book a > test drive > AMG test drive



> Find a Retailer



> View the Range Guide





> View offers



Book a > test drive > AMG test drive



> Find a Retailer



> View the Range Guide





> View offers



Book a > test drive > AMG test drive



> Find a Retailer



> View the Range Guide

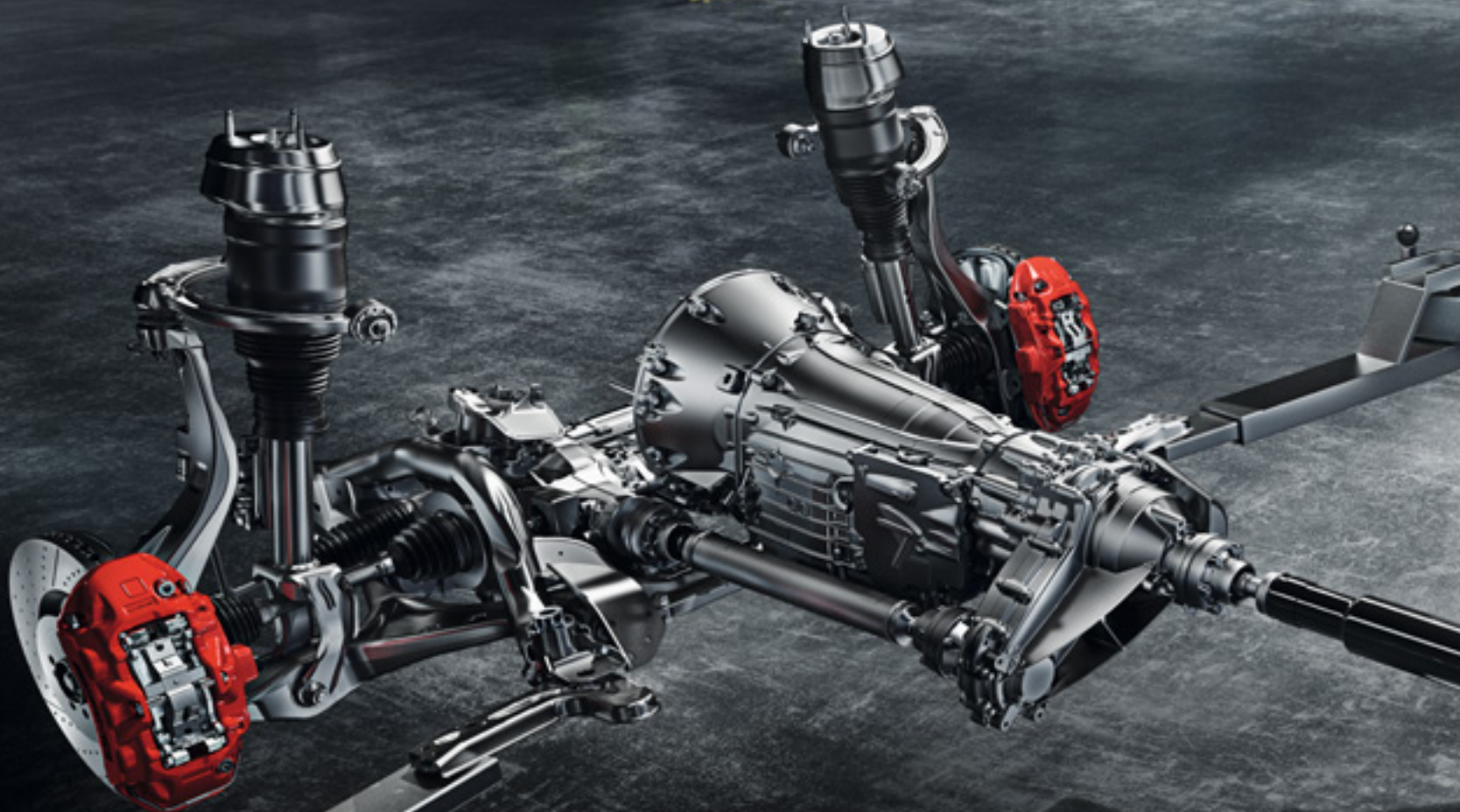





> View offers



Book a > test drive > AMG test drive



> Find a Retailer



> View the Range Guide

## Make the most of every street. Even if there are none.

On the highway, in fast corners or in the field - the AMG Performance 4MATIC makes every terrain the best. The permanent all-wheel drive distributes drive power 40:60 to front and rear axles, and the ACTIVE CURVE SYSTEM with active suspension stabilises body roll. This guarantees assured, predictable handling with more traction, directional stability and greater agility around the vehicle's vertical axis. But what you make of it is, of course, entirely up to you.



[View offers](#)



[Book a test drive](#) [AMG test drive](#)



[Find a Retailer](#)



[View the Range Guide](#)



Some of the model features, optional extras and colours shown may not be available, or may only be available in a different specification.



> View offers



Book a > test drive > AMG test drive



> Find a Retailer



> View the Range Guide



Some of the model features, optional extras and colours shown may not be available, or may only be available in a different specification.



[View offers](#)



[Book a test drive](#) [AMG test drive](#)



[Find a Retailer](#)



[View the Range Guide](#)



Some of the model features, optional extras and colours shown may not be available, or may only be available in a different specification.



> View offers



Book a > test drive > AMG test drive



> Find a Retailer



> View the Range Guide



Some of the model features, optional extras and colours shown may not be available, or may only be available in a different specification.



# Model prices

Engine	Model line	Transmission	CO <sub>2</sub>	Basic RRP excl. VAT (£)	Total RRP incl. VAT (£)	Road Fund Licence (£) <sup>1</sup>	Rec. OTR price (£) <sup>2</sup>	P11D value (£)	BiK tax rate 2017/18 (%)
<b>GLS 350d 4MATIC</b> Diesel – 2,987 cc, 6-cylinder, 258 hp/190 kW	AMG Line	9G-TRONIC 9-speed automatic	199	57,929.17	69,515.00	1,200.00	71,430.00	70,175.00	37
	designo Line	9G-TRONIC 9-speed automatic	199	65,425.00	78,510.00	1,200.00	80,425.00	79,170.00	37

## Mercedes-AMG

<b>Mercedes-AMG GLS 63 4MATIC</b> Petrol – 5,461 cc, 8-cylinder, 585 hp/430 kW	-	AMG SPEEDSHIFT PLUS 7G-TRONIC 7-speed auto.	288	85,112.50	102,135.00	2,000.00	104,850.00	102,795.00	37
---	---	---	-----	-----------	------------	----------	------------	------------	----

<sup>1</sup>A different first year rate of Vehicle Excise Duty (Road Fund Licence) applies for new cars. Please refer to page 59 for the relevant rate for the second and subsequent years

<sup>2</sup>The recommended on-the-road price includes the Road Fund Licence applicable to the standard model plus delivery charge (£635.00 incl. VAT), new vehicle registration fee (£55.00) and number plates (£25.00 incl. VAT). VAT is calculated at the standard rate of 20%. All models feature ECO start/stop function and Speedtronic cruise control



> View offers



Book a > test drive > AMG test drive



> Find a Retailer



> View the Range Guide

# Mercedes-Benz Finance

Where the clever money goes



## GLS 350 d 4MATIC AMG Line (representative example)

*Based on 10,000 miles per annum*

36 monthly payments of <sup>1</sup>	£799.00
Customer deposit	£12,350.00
On-the-road price	£71,385.00
Retailer deposit contribution	£3,225.22
Optional purchase payment <sup>2</sup>	£33,725.00
Amount of credit	£55,809.78
Duration of agreement	36 months
Total amount payable <sup>3</sup>	£78,074.22
Purchase activation fee <sup>2</sup>	£10.00
APR	5.0%
Fixed interest rate	4.91%
Excess mileage	24p per mile



### Example offers – 5.0% APR Representative

	Automatic	Metallic	On-the-road price	Retailer deposit contribution	Customer deposit	36 monthly payments of <sup>1</sup>
GLS 350 d 4MATIC AMG Line	●	●	£71,385.00	£3,225.22	£12,350.00	£799.00

● Standard equipment included in the price

### Mercedes-Benz Service Care

- Mercedes-Benz trained Technicians
- Maintained by Mercedes-Benz Retailers
- Meets requirements of Mercedes-Benz Agility finance agreement

### Mercedes-Benz Motor Insurance

- 24/7 UK accident recovery
- We use Mercedes-Benz GenuineParts
- To qualify for up to 10% discount online, go to [www.mercedes-benz.co.uk/motorinsurance](http://www.mercedes-benz.co.uk/motorinsurance)
- Alternatively, call Mercedes-Benz Motor Insurance now on **0345 600 2180<sup>4</sup>** for an annual quote

We may decline to quote in some circumstances. Mercedes-Benz Motor Insurance is underwritten by Aviva Insurance Limited

Content relating to finance is promoted by Mercedes-Benz Finance. Your Retailer may offer finance on behalf of other companies.

Orders/credit approvals on selected GLS models only, between 1 April and 30 June 2017, registered by 30 September 2017; excluding Mercedes-AMG models. Some combinations of features/options may not be available. Please contact your local Mercedes-Benz Retailer for availability

<sup>1</sup>Based on a Mercedes-Benz Agility agreement. Vehicle condition, excess mileage and other charges may be payable. Quotations available on request for alternative contract lengths and mileages. Guarantees may be required.

Credit provided, subject to status, by Mercedes-Benz Finance, MK15 8BA

<sup>2</sup>Payable if you exercise the option to purchase the car

<sup>3</sup>Includes optional purchase payment, purchase activation fee and Retailer deposit contribution (where applicable)

<sup>4</sup>Calls are charged at local rate and may be recorded





> View offers



Book a > test drive > AMG test drive



> Find a Retailer



> View the Range Guide

# Mercedes-Benz Finance

Even the finance offer is beautifully put together



## Mercedes-AMG GLS 63 4MATIC (representative example)

*Based on 10,000 miles per annum*

36 monthly payments of <sup>1</sup>	£1,399.00
Customer deposit	£10,549.00
On-the-road price	£104,805.00
Retailer deposit contribution	£5,730.94
Optional purchase payment <sup>2</sup>	£48,400.00
Amount of credit	£88,525.06
Duration of agreement	36 months
Total amount payable <sup>3</sup>	£115,053.94
Purchase activation fee <sup>2</sup>	£10.00
APR	5.0%
Fixed interest rate	4.91%
Excess mileage	37.2p per mile



### Example offers – 5.0% APR Representative

	Automatic	Metallic	On-the-road price	Retailer deposit contribution	Customer deposit	36 monthly payments of <sup>1</sup>
Mercedes-AMG GLS 63 4MATIC	●	●	£104,805.00	£5,730.94	£10,549.00	£1,399.00

● Standard equipment included in the price

### Mercedes-Benz Service Care

- Mercedes-Benz trained Technicians
- Maintained by Mercedes-Benz Retailers
- Meets requirements of Mercedes-Benz Agility finance agreement

### Mercedes-Benz Motor Insurance

- 24/7 UK accident recovery
- We use Mercedes-Benz GenuineParts
- To qualify for up to 10% discount online, go to [www.mercedes-benz.co.uk/motorinsurance](http://www.mercedes-benz.co.uk/motorinsurance)
- Alternatively, call Mercedes-Benz Motor Insurance now on **0345 600 2180**<sup>4</sup> for an annual quote

We may decline to quote in some circumstances. Mercedes-Benz Motor Insurance is underwritten by Aviva Insurance Limited

Content relating to finance is promoted by Mercedes-Benz Finance. Your Retailer may offer finance on behalf of other companies.

Orders/credit approvals on selected Mercedes-AMG GLS 63 models only, between 1 April and 30 June 2017, registered by 30 September 2017; excluding non-Mercedes-AMG models. Some combinations of features/options may not be available. Please contact your local Mercedes-Benz Retailer for availability

<sup>1</sup>Based on a Mercedes-Benz Agility agreement. Vehicle condition, excess mileage and other charges may be payable. Quotations available on request for alternative contract lengths and mileages. Guarantees may be required.

Credit provided, subject to status, by Mercedes-Benz Finance, MK15 8BA

<sup>2</sup>Payable if you exercise the option to purchase the car

<sup>3</sup>Includes optional purchase payment, purchase activation fee and Retailer deposit contribution (where applicable)

<sup>4</sup>Calls are charged at local rate and may be recorded



> View offers



Book a > test drive > AMG test drive



> Find a Retailer



> View the Range Guide

## GLS AMG Line



Optional wood- and leather-trimmed steering wheel (code 289) shown



The new GLS AMG Line exterior comprises AMG bodystyling all round with running boards in aluminium finish, and 21" AMG 5-twin-spoke alloy wheels with perforated front brake discs and brake calipers with 'Mercedes-Benz'

lettering. Inside, the AMG Line features heated front and rear seats in leather with black poplar wood trim. For your entertainment, the COMAND Online system<sup>1</sup> features an 8-inch tablet-style colour display and touchpad.

#### Exterior

KEYLESS-GO Comfort package

Lane Tracking package – including Blind Spot Assist and Lane Keeping Assist

Mirror package – including projection of Mercedes-Benz logo integrated into both mirrors

21" AMG 5-twin-spoke alloy wheels and flared wheel arches

Active Parking Assist with PARKTRONIC and 360° camera

AIRMATIC air suspension with Adaptive Damping System ADS PLUS

AMG bodystyling and aluminium finish running boards with rubber studs and LED illumination

DYNAMIC SELECT with a choice of driving modes

EASY-PACK powered tailgate

Headlamps – LED Intelligent Light System and Adaptive Highbeam Assist Plus

Panoramic electric glass sunroof

Privacy glass

Sports braking system with perforated front brake discs and brake calipers with 'Mercedes-Benz' lettering

#### Interior

Memory package – including driver's seat, front passenger seat, steering column and exterior mirrors, all electrically adjustable with memory

Ambient lighting

COMAND Online system<sup>1</sup> with 8-inch display and multi-touch control touchpad

DAB digital radio tuner

Double sun visors with illuminated vanity mirrors

Front and rear seats – heated

Rear seats, third row – electrically folding and raising, plus EASY-ENTRY to third row with backrests of second row folding forward at touch of a button

Seven seats

Surround sound system – Harman Kardon<sup>®</sup> Logic 7<sup>®</sup> with Dolby Digital 5.1 and DTS

THERMOTRONIC – luxury automatic climate control Multi-zone function with separate air distribution settings for driver, front passenger and rear. Three different climate modes: Focused, Medium and Diffuse

#### Trim and Upholstery

Black poplar wood

Leather – black

Leather – ginger beige/espresso brown

Leather – saddle brown/black

Leather – crystal grey/black

Leather – ginger beige/black

<sup>1</sup>Online functionality and Wi-Fi connectivity is dependent on a compatible cellular data connection. Please check with your local Mercedes-Benz Retailer on network compatibility



> View offers



Book a > test drive > AMG test drive



> Find a Retailer



> View the Range Guide

## GLS designo Line



The designo Line adds a range of exclusive features, such as 21" AMG multi-spoke alloy wheels with flared wheel arches and the ACTIVE CURVE SYSTEM for enhanced ride comfort. The interior stands out with its very own designo Interior package, comprising seats upholstered in designo Nappa leather with diamond-pattern quilting and black poplar wood trim. Front seats are climatized and come with massage function, 4-way lumbar support and luxury head restraints. THERMOTRONIC luxury climate control

and the interior air ionisation with air filter adds to your sense of well-being on board this luxurious GLS.

**designo Line upgrade** – designed and priced as a package, including all AMG Line equipment plus additional items as listed below.

**Upgrade price (from AMG Line)**

**Total incl. VAT<sup>1</sup> £8,995.00**

#### Exterior

21" AMG multi-spoke alloy wheels and flared wheel arches

#### ACTIVE CURVE SYSTEM

Enhances ride comfort, agility and safety at high speed, when cornering and when driving off-road

Closing aid for doors and boot lid

#### Interior

#### designo Interior package

designo seats with diamond-pattern quilting and designo badge, dashboard and door trim in designo leather, designo headlining in black or porcelain DINAMICA microfibre, double sun visors in DINAMICA microfibre

Cup holders – temperature controlled, for driver and front passenger

Front seats – climatized

Front seats – multi-contour seats with massage function

Heated multifunction steering wheel

Interior air ionisation with air filter

Sun blinds – rear side windows

THERMOTRONIC – luxury automatic climate control, third seat row

Rear passengers enjoy even greater climate comfort with an additional climate zone for the third seat row. Temperature and air distribution can be individually set for the rear compartment using a control panel on the rear of the centre console

#### Trim and Upholstery

Black poplar wood

designo Nappa leather – espresso brown

designo Nappa leather – porcelain/black

<sup>1</sup>Recommended Retail Price



> View offers



Book a > test drive > AMG test drive



> Find a Retailer



> View the Range Guide

## Mercedes-AMG GLS 63 4MATIC



Standard AMG high-performance braking system with red brake calipers not shown



Optional trim (code H10) shown



The new Mercedes-AMG GLS 63 4MATIC displays its superiority in every respect with its powerful engine, dominant exterior and distinctive AMG design. Along with the 'V8 BITURBO' lettering on the front wings, you can't miss the 21" bicolour AMG alloy wheels with red brake calipers and the AMG sports exhaust system with two chromed twin tailpipes. The interior is

brimming with luxurious AMG touches, starting with AMG Exclusive Nappa leather upholstery, AMG sports seats and the AMG performance steering wheel. AMG floor mats with 'AMG' lettering and brushed stainless steel sports pedals with rubber studs are also standard.

#### Exterior





- 21" AMG multi-spoke alloy wheels, bicolour titanium grey
- ACTIVE CURVE SYSTEM  
Enhances ride comfort, agility and safety at high speed, when cornering and when driving off-road
- AMG bodystyling
- AMG high-performance braking system with red brake calipers
- AMG sports exhaust system with two chromed twin tailpipes
- Closing aid for doors and boot lid
- 'V8 BITURBO' lettering on front wings

#### Interior

- AMG brushed stainless steel sports pedals with rubber studs
- AMG floor mats with 'AMG' lettering
- AMG instrument cluster

- AMG performance steering wheel
- AMG sports seats with AMG-specific seat upholstery layout, optimised lateral support and AMG badge in front seat backrests
- Cup holders - temperature controlled, for driver and front passenger
- Front seats - climatized
- Front seats - multi-contour seats with massage function
- Interior air ionisation with air filter
- Sun blinds - rear side windows
- THERMOTRONIC - luxury automatic climate control
- THERMOTRONIC - luxury automatic climate control, third seat row

#### Trim and Upholstery

- Black poplar wood
-  AMG Exclusive Nappa leather - black with beige stitching
-  AMG Exclusive Nappa leather - espresso brown/black
-  AMG Exclusive Nappa leather - porcelain/black
- 





## Exclusive driver training for Mercedes-AMG GLS 63 4MATIC owners

All Mercedes-AMG GLS 63 4MATIC customers are invited to a complimentary AMG Driving Academy Training experience at Mercedes-Benz World.



With friendly one-to-one tuition from a professional Mercedes-AMG driver, your training will be personalised to you. You'll push Mercedes-AMG driving performance and your driving skills to the limits on our track and purpose-built low friction dynamic handling facilities.

Through high-speed and adrenaline-fuelled exercises you'll experience oversteer, understeer, slaloms and many more performance driving skills. Designed as part of your ownership experience, this will lay the foundations to master a high-performance vehicle, develop driving skills with maximum enjoyment and prepare you to take full command of your own Mercedes-AMG.

### TERMS AND CONDITIONS

The following only are eligible: the first purchaser/registered keeper of a newly-registered Mercedes-AMG GLS 63 4MATIC; the second owner/registered keeper of a Mercedes-AMG purchased from a Mercedes-Benz Retailer, where the vehicle is less than 90 days from registration. The AMG Driving Academy Training experience is the AMG BASIC-Training as detailed in the further information above and must be booked and taken within six months of delivery of your Mercedes-AMG GLS 63 4MATIC; it cannot be exchanged and cannot be transferred for any other driving experience. The Training experience is available Monday to Friday only and is subject to availability. Mercedes-Benz UK Limited reserves the right to amend or withdraw this Training experience. Attendees must hold a full UK driving licence. Attendees will be required to sign the Mercedes-Benz World Driving Risk Acknowledgement prior to undertaking the Training experience. The Training experience is also subject to the Mercedes-Benz World Terms and Conditions, as applicable.



> View offers



Book a > test drive > AMG test drive



> Find a Retailer



> View the Range Guide





> View offers



Book a > test drive > AMG test drive



> Find a Retailer



> View the Range Guide

# Standard equipment



Panoramic glass sunroof



Memory package



Surround sound system - Harman Kardon® Logic 7®



Active Parking Assist with PARKTRONIC and 360° camera



Lane Tracking package



EASY-ENTRY system power release



Item	AMG Line	designo Line	Mercedes-AMG
<b>Transmission and Suspension</b>			
Driving modes – DYNAMIC SELECT with a choice of driving modes: Comfort, Sport, Slippery, Off-road and Individual	●	●	–
Driving modes – DYNAMIC SELECT with a choice of driving modes: Comfort, Sport, Slippery, Sport+ and Individual	–	–	●
ECO start/stop function	●	●	●
Permanent four-wheel drive	●	●	●
Suspension – ACTIVE CURVE SYSTEM Enhances ride comfort, agility and safety at high speed, when cornering and when driving off-road	○	●	●
Suspension – AIRMATIC air suspension with Adaptive Damping System	–	●	–
Suspension – AIRMATIC air suspension with Adaptive Damping System ADS PLUS (with added comfort)	●	–	–
Suspension – AMG sports suspension based on AIRMATIC with Adaptive Damping System	–	–	●
Transmission – 9G-TRONIC automatic transmission with steering column gear selector, DIRECT SELECT steering wheel gearshift paddles, cruise control and speed limiter	●	●	–
Transmission – AMG SPEEDSHIFT PLUS 7G-TRONIC automatic transmission with steering column gear selector, DIRECT SELECT steering wheel gearshift paddles, cruise control and speed limiter	–	–	●

Item	AMG Line	designo Line	Mercedes-AMG
<b>Steering</b>			
Direct-Steer system with speed-sensitive power assistance	●	●	●
Steering wheel – 4-spoke AMG performance steering wheel in black nappa leather/ DINAMICA microfibre	–	–	●
Steering wheel – 3-spoke heated multifunction steering wheel	–	●	–
Steering wheel – 3-spoke multifunction steering wheel in nappa leather	●	–	–
Steer Control – can perform corrective intervention in the event of the vehicle oversteering and when braking on road surfaces offering different levels of grip	●	●	●
<b>Exterior</b>			
KEYLESS-GO Comfort package The vehicle can be conveniently unlocked, started and locked – simply by carrying the electronic key	●	●	●
Mirror package – including projection of Mercedes-Benz logo integrated into both mirrors Including heated exterior mirrors, automatically dimming rear view mirror and exterior mirror on driver's side and electrically folding exterior mirrors left and right	●	●	●
AMG bodystyling – front apron, rear apron, side skirts and flared wheel arches	●	●	●
AMG high-performance braking system with red brake calipers Delivers excellent stopping power plus precision brake control with internally ventilated and perforated brake discs all round	–	–	●
AMG sports exhaust system with two chromed twin tailpipes	–	–	●



Item	AMG Line	designo Line	Mercedes-AMG
<b>Exterior (continued)</b>			
Closing aid for doors and boot lid Power closing ensures smooth and virtually silent closing. Once they have initially engaged, the front and rear doors are automatically drawn closed by servomotors	-	●	●
Diesel Particulate Filter (DPF)	●	●	-
EASY-PACK powered tailgate The EASY-PACK boot lid can be opened and closed at the touch of a button for more convenient loading and unloading of the boot	●	●	●
Heated windscreen washer system	●	●	●
Lights – Adaptive Highbeam Assist Plus	●	●	●
Lights – Headlamp Assist: automatic headlamp activation	●	●	●
Lights – LED Intelligent Light System LED headlamps, highbeam and direction indicator LED position light, cornering light and daytime running lamps Dynamic headlamp range adjustment for ideal visibility in all weather, lighting and driving conditions Variable light distribution for driving on country roads and motorways as well as in heavy fog Active light function allows headlamps to pivot into bends by up to 15° to illuminate road surface more effectively, improving visibility Cornering light function: two LEDs per headlamp improve road illumination in tight bends by automatically switching on cornering light on the relevant side Enhanced fog lamp function illuminates outer half of the carriageway more effectively while reducing glare due to light reflected by fog. Can be activated at speeds below 44 mph and remains switched on up to 62 mph Welcome home function lights up LED fibre optics in the headlamps in blue after unlocking the vehicle, transitioning to white locator lighting	●	●	●

Item	AMG Line	designo Line	Mercedes-AMG
Lights – LED tail lamps	●	●	●
Panoramic glass sunroof Consists of a fixed panoramic glass sunroof above the second seat row; an electrically operated sliding glass front section and also includes electrically operated vent windows for third seat row	●	●	●
Privacy glass – dark glass from B-pillar backwards	●	●	●
Rain-sensing wipers	●	●	●
Roof rails in chrome look	●	●	●
Running boards – illuminated, with rubber studs	●	●	●
Tinted glass all round – single-layer safety glass	●	●	●
'V8 BITURBO' lettering on front wings	-	-	●



Item	AMG Line	designo Line	Mercedes-AMG
<b>Interior</b>			
designo Interior package designo seats with diamond-pattern quilting and designo badge, dashboard and door trim in designo leather, designo headlining in black or porcelain DINAMICA microfibre, double sun visors in DINAMICA microfibre	-	●	-
Memory package Front seats, front head restraints, steering column and exterior door mirrors – electrically adjustable with memory. Four-way electric lumbar support for driver and front passenger seat	●	●	●
12 V socket in load compartment and passenger compartment, front and rear	●	●	●
Air conditioning – interior air ionisation with air filter	-	●	●
Air conditioning – THERMOTRONIC luxury automatic climate control Multi-zone function with separate air distribution settings for driver, front passenger and rear. Three different climate modes: Focused, Medium and Diffuse	●	●	●
Air conditioning – THERMOTRONIC luxury automatic climate control, third seat row Rear passengers enjoy even greater climate comfort with an additional climate zone for the third seat row. Temperature and air distribution can be individually set for the rear compartment using a control panel on the rear of the centre console	-	●	●
Ambient lighting in a choice of three colours for trim, illumination for double cup holder, rear footwells, rotary air vent controls and also warning/courtesy lights in the rear	●	●	●

Item	AMG Line	designo Line	Mercedes-AMG
Centre armrests – front, with stowage compartment	●	●	●
Centre armrests – rear, folding	●	●	●
Cup holders – front (2) and rear	●	●	●
Cup holders – temperature-controlled for driver and front passenger	-	●	●
Door sills – front door sill panels in brushed stainless steel with ‘AMG’ lettering illuminated in white	-	-	●
Door sills – front door sill panels with ‘Mercedes-Benz’ lettering illuminated in white	●	●	-
Double sun visors with illuminated vanity mirrors	●	●	●
Floor mats – AMG floor mats with edging and embroidered ‘AMG’ lettering	-	-	●
Floor mats – velour floor mats Coloured the same as the car’s appointments, the velour floor mats fit in perfectly with the high-quality interior and effectively protect the footwell against soiling	●	●	-
Instrument cluster – AMG instrument cluster with animated start-up sequence and AMG main menu	-	-	●
Instrument cluster – outside temperature display, rear seat belt status indicator	●	●	●
Reading lights – front and rear	●	●	●



Item	AMG Line	designo Line	Mercedes-AMG
<b>Interior (continued)</b>			
Seats – AMG sports seats with AMG-specific seat upholstery layout, optimised lateral support and AMG badge in front seat backrests	-	-	●
Seats – front seats, heated	●	-	-
Seats – front seats, climatised	-	●	●
Seats – front seats, multi-contour seats with massage function	-	●	●
Seats – rear seats, second row: heated	●	●	●
Seats – rear seats, third row: electrically folding and raising with EASY-ENTRY system power release This system facilitates access to the third seat row from both sides at the touch of a button. The backrests and bench seat of the second row of seats can be folded forward electrically with a split of 60% (left) to 40% (right). Pressing these switches causes the head restraints to retract electrically, while the backrests fold down. The bench seat is then folded forward	●	●	●
Sports pedals in brushed stainless steel with rubber studs	-	-	●
Stowage – EASY-PACK load compartment cover (removable)	●	●	●
Stowage – load-securing rings (6)	●	●	●
Sun blinds – rear side windows (manually operated)	-	●	●

Item	AMG Line	designo Line	Mercedes-AMG
<b>Paint, Trim and Upholstery</b>			
Dashboard – upper section in ARTICO leather <sup>1</sup>	●	-	-
Dashboard – upper and lower sections, beltline and door panels in ARTICO leather <sup>1</sup>	○	●	●
Paint – non-metallic or metallic	●	●	●
Trim – black poplar wood	●	●	●
Upholstery – AMG Exclusive nappa leather	-	-	●
Upholstery – designo nappa leather	-	●	-
Upholstery – leather	●	-	-



Item	AMG Line	designo Line	Mercedes-AMG
<b>Communications and In-Car Entertainment</b>			
Bluetooth® interface for hands-free telephony and audio streaming for music transmission	●	●	●
Central controller dial to operate audio functions and telephone (when connected)	●	●	●
COMAND Online system <sup>1</sup> with Media Interface and touchpad Includes radio, single CD/DVD, 8 speakers, 8-inch colour display, hard disk drive (HDD) navigation with 3D map display, Live Traffic Information and European map data updates free of charge for the first three years and LINGUATRONIC voice control. Internet-enabled mobile phone required for Mercedes-Benz emergency call system (eCall), Mercedes-Benz apps and in-car internet access for Facebook, internet radio, sending routes from Google Maps™ to the vehicle, news and weather reports. Also includes SD memory card slot and MP3 compatibility. Media Interface allows connection and control of portable media devices (e.g. MP3 player, USB storage media). Cable included for iPod® connectivity	●	●	●
DAB digital radio tuner	●	●	●
Mercedes me connect services – for example accident recovery, breakdown management and maintenance management, or telediagnosics for worn parts	●	●	●
Smartphone integration Comprising Apple CarPlay™ and Android Auto. Please check on <a href="http://www.apple.com/uk/ios/carplay/">www.apple.com/uk/ios/carplay/</a> or <a href="http://www.android.com/intl/en_uk/auto">www.android.com/intl/en_uk/auto</a> for compatibility and approved apps. Certain features and apps require a 3G or 4G data connection. Control of features available through voice control and controller on centre console	●	●	●
Surround sound system – Harman Kardon® Logic 7® with Dolby Digital 5.1 and DTS 14 high-performance speakers and total output of 830 watts	●	●	●
USB ports (2) in centre console	●	●	●

Item	AMG Line	designo Line	Mercedes-AMG
<b>Safety and Assistance Systems</b>			
Lane Tracking package Blind Spot Assist – when a vehicle is detected in the blind spot, a red triangle lights up in the exterior mirror. If the driver overlooks this warning and operates the direction indicators, an acoustic warning is additionally sounded. Lane Keeping Assist – the system is able to recognise when the vehicle is unintentionally drifting out of lane, warning the driver by means of pulsed vibrations on the steering wheel	●	●	●
Active bonnet – pedestrian safety measure	●	●	–
Active Brake Assist The driver is given a visual warning if the distance from a vehicle in front is inadequate. On detecting the danger of a collision there is an acoustic warning, driver braking can be assisted and, if the driver fails to react, the speed can be reduced autonomously. Autonomous partial braking only occurs if the driver fails to react and is travelling at a speed range between 4–65 mph speeds for moving objects and 4–31 mph for stationary objects	●	●	●
Airbags – driver and front passenger	●	●	●
Airbags – front sidebags	●	●	●
Airbags – kneebag for driver	●	●	●
Airbags – rear sidebags, left and right	●	●	●
Airbags – windowbags	●	●	●
Alarm system with immobiliser and interior protection (MBSS3)	●	●	●
Anti-lock braking system (ABS) with Brake Assist (BAS)	●	●	●





Item	AMG Line	designo Line	Mercedes-AMG
<b>Safety and Assistance Systems (continued)</b>			
ATTENTION ASSIST Continuously analyses driver behaviour and steering movements. If patterns are recognised which characterise drowsiness, the driver is prompted to take a break, and an audible warning is sounded. At the same time COMAND Online offers to locate a rest stop	●	●	●
Automatic child seat recognition sensor	●	●	●
Braking – adaptive Brake Assist with HOLD function, Hill Start Assist, priming and dry braking in the wet	●	●	●
Braking – adaptive brake lights	●	●	●
Braking – AMG high-performance braking system	–	–	●
Braking – electric parking brake	●	●	●
Braking – Electronic Stability Programme (ESP®) with Acceleration Skid Control (ASR)	●	●	●
Braking – third brake lamp, LED technology	●	●	●
Collapsible spare wheel	●	●	●
Crosswind Assist Detects sudden, strong gusts of wind and helps the driver stay in lane by means of targeted braking	●	●	●
Downhill Speed Regulation (DSR) with on/off switch and variable speed control	●	●	●

Item	AMG Line	designo Line	Mercedes-AMG
First-aid kit and warning triangle	●	●	●
Four-wheel Electronic Traction System (4ETS)	●	●	●
Hill-Start Assist	●	●	●
Parking – Parking Pilot with 360° camera The Parking Pilot makes finding a parking space as well as parking in and leaving parallel or on-end parking spaces easier. The 360° camera enables parking and manoeuvring with a realistic all-round view thanks to the interaction of four networked cameras	●	●	●
PRE-SAFE® anticipatory safety system with reversible belt tensioners for driver and front passenger seats, closing function for side windows	●	●	●
Remote central locking	●	●	●
Seats – ISOFIX and top-tether child seat fixing points in rear (two outer seats)	●	●	●
Service indicator ASSYST	●	●	●
Traffic Sign Assist Speed Limit Assist with wrong-way warning function and display of speed limit in instrument cluster	●	●	●
Tyre pressure monitoring system	●	●	●



> View offers



Book a > test drive > AMG test drive



> Find a Retailer



> View the Range Guide

# A revolution in style

Item	Notes		AMG Line	designo Line	Mercedes-AMG	Basic RRP excl. VAT (£)	Total RRP incl. VAT (£)
<b>Wheels</b>							
21" AMG alloy wheels (4) - 5-twin-spoke design, painted in titanium grey 295/40 tyres			86R	●	-	-	-
21" AMG alloy wheels (4) - multi-spoke design 295/40 tyres			87R	-	●	-	-
21" AMG alloy wheels (4) - 5-twin-spoke design, bicolour 295/40 tyres			89R	△	△	-	Included in Night package
21" AMG alloy wheels (4) - multi-spoke design, bicolour titanium grey 295/40 tyres			689	-	-	●	-

● Standard ○ Optional - Not available △ Available as part of an option package



> View offers





Book a > test drive > AMG test drive



> Find a Retailer



> View the Range Guide

Item	Notes		AMG Line	designo Line	Mercedes-AMG	Basic RRP excl. VAT (£)	Total RRP incl. VAT (£)
<b>Wheels (continued)</b>							
21" AMG alloy wheels (4) – multi-spoke design, painted in matt black 295/40 tyres			692	-	-	△	Included in Night package
22" AMG alloy wheels (4) – multi-spoke design 285/40 tyres			88R	-	-	○	829.17      995.00
22" AMG alloy wheels (4) - multi-spoke design, painted in matt black 285/40 tyres			90R	-	-	○	1,245.83      1,495.00



## Seating – seat comfort



The multi-contour seats<sup>1</sup> with massage function offer optimum seating comfort for driver and front passenger. Various air chambers allow seats to be individually adjusted to an occupant's stature – from the seat cushion depth on the side bolsters to the position and form of the backrest curvature. Lumbar support additionally cushions the spine. A massage function, with seven zones and two selectable intensities, will help to reduce tension on longer journeys. A final touch of comfort: the fittings are completed by luxury head restraints.

---

At the press of a button, the EASY-ENTRY system electrically facilitates getting into the third row of seats from both sides. The second row of seats can separately be folded forward in a ratio 40% right:60% left

---

The Memory package can accommodate up to three separate occupants: different positions of the electrically adjustable front seats, steering column and exterior mirrors can each be stored and recalled at your fingertips

---

On hot days, active ventilation in the comfort-ventilated front seats quickly cools the cushion surface to a pleasant temperature creating a well-balanced seat climate. In the cold season, switchable seat heating provides warmth as desired

---



<sup>1</sup>Standard for designo Line and Mercedes-AMG GLS 63 4MATIC



## Seating - versatility



The GLS provides a carrying capacity up to 2,300 litres – the largest cargo space in its segment. Behind the second seat row 680l stands ready for loading. The standard EASY-PACK tailgate, 60:40 folding rear seats and the standing height of 1.95 m under the open tailgate provides a load space that can be used flexibly and allows convenient loading and unloading.

---

The EASY-PACK tailgate can be opened or closed at the press of a button, allowing convenient loading and unloading of the cargo space

---

The EASY-PACK load compartment cover shields luggage from the sun or from prying eyes. It consists of a blind mounted behind the rear seats, and can always be removed

---

To facilitate the transportation of long objects, a practical through-loading feature is available above the armrest in the rear. A flap for loading is opened from the luggage compartment

---

Six lashing eyes are available on the luggage compartment floor and on the legs of the third seat row. Foldable bag hooks are offered in the cargo area

---





# Night package

## GLS 350 d 4MATIC



The Night package underscores the sporty, expressive character of the GLS with striking design elements in black. The radiator louvres and simulated underguard front and rear are finished in high-gloss black with tailpipe trim elements in black. Further highlights include 21" AMG alloy wheels and exterior mirrors, beltline trim strips, roof rails and weatherstrip in high-gloss black.

**Night package** – designed and priced as a package, including items as listed below.

### GLS 350 d 4MATIC

**Total incl. VAT £595.00**

### Mercedes-AMG GLS 63 4MATIC

**£995.00**

## Mercedes-AMG GLS 63 4MATIC



Optional multi-spoke wheels (code 90R) shown

Item	Night package £595.00 (code P55)	AMG Night package £995.00 (code P55)
Includes a high-gloss black louvre in the radiator grille, high-gloss black exterior mirrors, beltline trim strips, roof rails and weatherstrip	■	■
21" AMG bi-colour alloy wheels (4) - 5-twin-spoke design (code 89R)	■	-
21" AMG alloy wheels (4) - multi-spoke design, painted in matt black (code 692)	-	■
A-wing and insert in front apron in high-gloss black	-	■
Twin tailpipe trim elements in black	-	■

■ Included - Not included



# Driving Assistance package

This comprehensive package includes many advanced features to help keep you safe on the road: Active Blind Spot Assist monitors the obscure area to the side and rear. The innovative driver assistance system DISTRONIC PLUS cruise control helps to automatically maintain a safe distance from the vehicle ahead. Active Lane Keeping Assist is able to recognise when the vehicle is unintentionally drifting out of its lane, and duly warns the driver with pulsed vibrations on the steering wheel. Plus the renowned PRE-SAFE® safety system can detect critical road situations and initiate preventive safety measures.

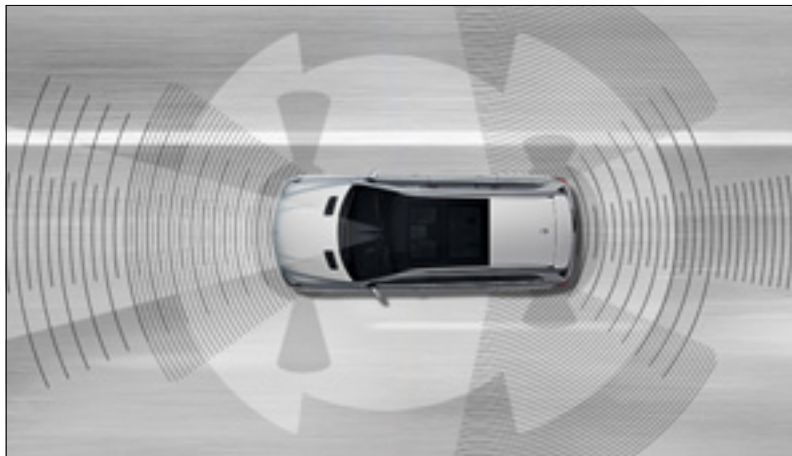

**Driving Assistance Plus package** (code 23P) – designed and priced as a package, including items as listed below.

**All models**

**Total incl. VAT £1,695.00**

Item	Notes
Active Blind Spot Assist	Displays a red triangle in the exterior mirrors: when a road user is detected in the blind spot, the red triangle flashes and an audible warning sounds if the driver operates the indicators. Includes course-correcting braking intervention
Active Brake Assistant with cross-traffic function	Active Brake Assistant can lower the risk of rear-end collisions and support the driver during emergency braking by providing additional brake pressure
Active Lane Keeping Assist	Detects signs of inadvertent drifting out of lane and warns the driver by vibrating the steering wheel and, if necessary, will trigger one-sided braking intervention
Distance Pilot DISTRONIC with Steering Pilot	Helps the driver maintain the desired distance to the vehicle in front, and helps with lane guidance
PRE-SAFE® PLUS	If a rear impact is imminent, this addition to the PRE-SAFE® system can initiate preventive occupant protection measures. These include warning the traffic following behind and locking the vehicle brakes when at a standstill if the driver indicates that he wishes to remain stationary



> View offers



Book a > test drive > AMG test drive



> Find a Retailer



> View the Range Guide

## Entertainment package



Films on DVD, music or television, the Entertainment package provides passengers in the rear with their very own programme of entertainment. Two 8-inch displays and two sets of headphones ensure brilliant picture and sound quality, and a TV tuner allows for digital TV reception.

**Entertainment package** – designed and priced as a package, including items as listed below.

**All models**

**Total incl. VAT £2,495.00**

**Entertainment package** (code DP7)

---

Rear seat entertainment, including two 8-inch displays integrated into the front seat head restraints, a DVD player, two set of headphones and one remote control

---

TV tuner for digital TV reception

---





## Off-Road package

The Off-Road package combines a host of features that come in handy when taking your GLS off the beaten track. For off-road operation there are the options 'Off-road' for sand and light terrain and also 'Off-road+' for difficult terrain. The low-range gearbox aids slow and careful driving in off-road terrain where a high level of tractive power is required, and supports controlled downhill driving, particularly on low-traction surfaces.

The driver can adjust the gear ratio even more precisely to the requirements of driving in extreme off-road terrain by using the manual mode of the 9G-TRONIC automatic transmission. A 100% differential lock on the centre differential improves traction in difficult terrain even further.

An underguard for the engine, together with reinforced underfloor panelling the full length of

the vehicle, helps to reduce damage caused, for example, by driving over obstacles. The three additional selectable off-road ride heights allow the ground clearance to be increased by 30, 60 or 90 mm, corresponding to a maximum wading depth of 600 mm.

Off-Road package – designed and priced as a package, including items as listed below.

### AMG Line and designo Line

**Total incl. VAT £1,985.00**



#### Off-Road package (code 430)

---

100% differential lock on centre differential

---

DYNAMIC SELECT with 'Off-road+' driving mode

---

Front and rear axles with adapted 4ETS

---

Guard under engine with reinforced underbody panelling

---

Low-range gearbox

---

Manual mode for automatic transmission

---

Special off-road algorithm for ABS, 4ETS and ESP®

---

Three additional selectable off-road ride heights

---



# Optional equipment

Item	Notes		AMG Line	designo Line	Mercedes-AMG	Basic RRP excl. VAT (£)	Total RRP incl. VAT (£)
<b>AMG Performance Studio</b>							
AMG Driver's package Increase in the electronically limited top speed to 168 mph and participation in driver training at the AMG Driving Academy	For further information on this or any other AMG Driving Academy training, please speak to your Retailer, or visit <a href="http://www.mercedes-amg.com/driving-academy">www.mercedes-amg.com/driving-academy</a>	250	-	-	○	2,350.00	<b>2,820.00</b>
AMG carbon fibre engine cover		B14	-	-	○	1,245.83	<b>1,495.00</b>
<b>Suspension and Exterior</b>							
ACTIVE CURVE SYSTEM With active suspension stabilisers. Enhances ride comfort, agility and safety at high speed, when cornering and when driving off-road		468	○	●	●	2,329.17	<b>2,795.00</b>
Tow bar – fully electric	When ordering this option, please discuss with your Retailer any specific towing requirements	550	○	○	○	791.67	<b>950.00</b>
<b>Paint, Trim and Upholstery</b>							
Dashboard – upper and lower sections, beltline and door panels in ARTICO leather <sup>1</sup>		U09	○	-	-	333.33	<b>400.00</b>
Paint – designo diamond white bright		799	○	○	○	704.17	<b>845.00</b>
Paint – designo hyacinth red bright		996	○	○	○	704.17	<b>845.00</b>
Roof lining – crystal grey fabric	Available with upholstery codes 211A/228A/531A	58U	○	-	○	83.33	<b>100.00</b>
Roof lining – porcelain fabric	Available with upholstery codes 215A/245A/534A/535A	55U	○	-	○	83.33	<b>100.00</b>
Steering wheel – wood- and leather-trimmed	Available with trim codes 729/731/734/H09/H21	289	○	-	-	412.50	<b>495.00</b>



Item	Notes	AMG Line designo Line Mercedes-AMG			Basic RRP excl. VAT (£)	Total RRP incl. VAT (£)	
<b>Paint, Trim and Upholstery (continued)</b>							
Trim – AMG carbon fibre/black piano lacquer		H10	○	○	–	916.67	1,100.00
			–	–	○	1,245.83	1,495.00
Trim – black piano lacquer		H21	○	○	○	162.50	195.00
Trim – brown open-pore ash wood		H09	○	○	○	no-cost option	
Trim – high-gloss brown burr walnut wood		731	○	○	○	no-cost option	
Trim – high-gloss brown eucalyptus wood		734	○	○	–	no-cost option	
Trim – light aluminium with longitudinal grain		739	○	○	○	no-cost option	
<b>Communications and In-Car Entertainment</b>							
Surround sound system – Bang & Olufsen BeoSound AMG 14 high-performance speakers with twin illuminated tweeter lenses	Please note that space-saver spare wheel is replaced by TIREFIT when ordering this option	811	○	○	○	2,495.83	2,995.00
Universal Telephony package in armrest with universal interface for universal cradle, extended telephone functionality, charging function and LTE-compatible exterior aerial for optimum reception		386	○	○	○	291.67	350.00



> View offers



Book a > test drive > AMG test drive



> Find a Retailer



> View the Range Guide

Optional equipment

44

Item	Notes	AMG Line designo Line Mercedes-AMG	Basic RRP excl. VAT (£)	Total RRP incl. VAT (£)												
<b>Service Package</b>																
Service Care Service Care allows you to spread the cost of servicing your new car in the Mercedes-Benz Retailer network. Taking out a Service Care plan ensures your servicing needs are taken care of by fully trained Mercedes-Benz Technicians with the added benefit of a Mercedes-Benz service history	Price is based on a monthly rate. Example given is for two services taken over 24 months or three services over 36 months. Further payment options are available. New Service Care prices apply only to vehicles up to 12 months old prior to first service. Prices effective from 3 May 2016	<table border="1"> <tr> <td data-bbox="1315 536 1343 601">1</td> <td data-bbox="1343 536 1371 601">○</td> <td data-bbox="1371 536 1399 601">○</td> <td data-bbox="1399 536 1427 601">-</td> </tr> <tr> <td data-bbox="1315 601 1343 662"></td> <td data-bbox="1343 601 1371 662">-</td> <td data-bbox="1371 601 1399 662">-</td> <td data-bbox="1399 601 1427 662">○</td> </tr> </table>	1	○	○	-		-	-	○	<table border="1"> <tr> <td data-bbox="1437 536 1602 601">32.50</td> </tr> <tr> <td data-bbox="1437 601 1602 662">37.50</td> </tr> </table>	32.50	37.50	<table border="1"> <tr> <td data-bbox="1602 536 1759 601">39.00</td> </tr> <tr> <td data-bbox="1602 601 1759 662">45.00</td> </tr> </table>	39.00	45.00
1	○	○	-													
	-	-	○													
32.50																
37.50																
39.00																
45.00																

● Standard ○ Optional - Not available



> View offers



Book a > test drive > AMG test drive



> Find a Retailer



> View the Range Guide

## Genuine Accessories

We've developed a range of Accessories you can add to help personalise and enhance your GLS. Your local Mercedes-Benz Retailer can advise on fitting costs of Accessories, where applicable. Further information on our full range of Genuine Accessories can be found on the Mercedes-Benz UK website.

### 01 | LED Mercedes star projector

The legendary three-pointed star logo is discreetly projected onto the ground alongside your vehicle every time you open the front driver or passenger door. The star automatically disappears once the doors are closed.

RRP £118.80 (incl. VAT), excluding fitting



### 02 | Illuminated Mercedes star

Every time you remotely unlock your vehicle or open the door or tailgate, the outline of the chrome-plated star emblem on the front of your vehicle is illuminated by cutting-edge LED technology. Illumination only functions when engine is switched off.

RRP £313.02 (incl. VAT), excluding fitting





> View offers



Book a > test drive > AMG test drive



> Find a Retailer



> View the Range Guide

### 03 | Illuminated running boards

The aluminium-look illuminated running boards are a real eye-catcher. They are mounted at the height of the side skirts and make it easier to get into the vehicle, front and rear. Rubber studs increase safety by helping to prevent slipping.

RRP £1,368.00 (incl. VAT), excluding fitting

### 04 | Garmin® MAP PILOT

Transforms your Audio 20 radio into a high-performance navigation system with 3D map views. Garmin® MAP PILOT uses the standard-fit 17.8 cm colour TFT display and can be conveniently operated via the vehicle's Controller and the Audio 20 keypad.

RRP £495.00 (incl. VAT), excluding fitting





> View offers



Book a > test drive > AMG test drive



> Find a Retailer



> View the Range Guide

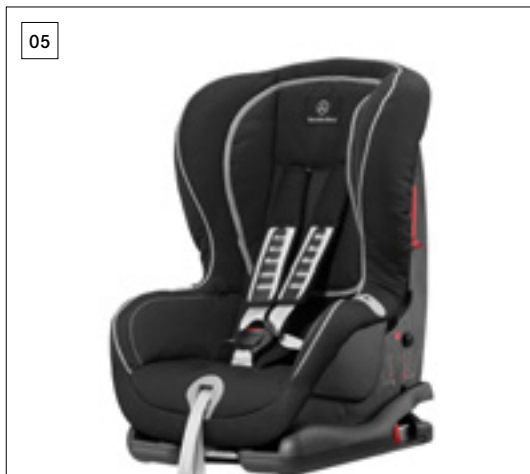

**05 | DUO plus child seat, with ISOFIX**

'DUO plus' child seat. Optimum safety for children between the ages of around 9 months and 4 years (9 to 18 kg). Fitted as standard with top tether, an additional belt for securing the head section, a height-adjustable harness, ventilation channels and ISOFIX attachment points. Adjustable tilt.

Additional seats available for ages 0+ (1 to 13 kg) and 3.5 to 12 years (15 to 36 kg).

**RRP £434.83 (incl. VAT)**

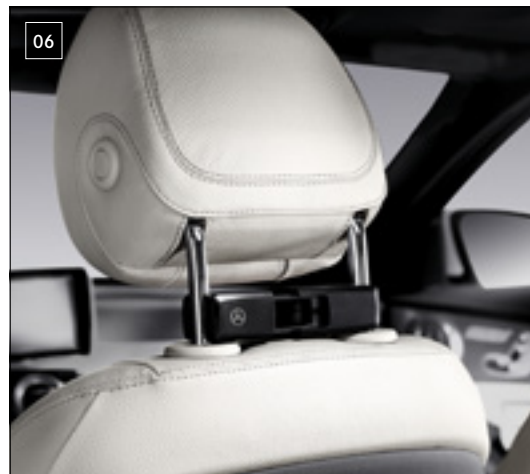

**06 | Head restraint modular system**

Carefree travel with Mercedes-Benz Style & Travel Equipment. The head restraint elements are simple to fit and remove. The modular system centres around a base support which can be combined with a coat hanger, universal hook, folding table and tablet mount.

Base support: **RRP £22.32 (incl. VAT)**

Coat hanger: **RRP £67.60 (incl. VAT)**

Folding table: **RRP £102.60 (incl. VAT)**





### 07 | Basic carrier bars

Aluminium carrier bars, precision-tailored to the body of your GLS – the perfect basis for a range of Mercedes-Benz transport solutions: ski and snowboard rack, bicycle rack or roof boxes.

RRP £219.00 (incl. VAT)

### 08 | Mercedes-Benz roof boxes

An aerodynamic design, tailored to your Mercedes-Benz. In extremely durable material. Designed for quick, optimised attachment to the basic carrier bars. Particularly convenient loading and unloading thanks to the option of double-sided opening. Lockable from both sides. Available in various sizes.

RRP from £361.64 (incl. VAT)

### 09 | Alustyle Bicycle rack

Extremely lightweight bicycle rack, designed to allow you to attach a bicycle to the basic carrier bars for roof rails. Bicycles can either be attached to the rack once it has been fitted to the roof or, conveniently, before it is fitted. The support frame can also be folded down when not in use to reduce drag when travelling without cycles.

RRP £121.00 (incl. VAT)







**10 | Shallow boot tub**

Made from impact-resistant, non-slip polypropylene. Suitable for transporting shopping. Structured surface holds separately available stowage crate in place.

RRP £99.50 (incl. VAT)

**11 | Stowage crate**

A secure hold for items which are liable to tip over or slide around. Optimum functionality only in conjunction with shallow boot tub.

RRP £87.50 (incl. VAT)

**12 | Concertina load sill protector**

Protects the rear of the vehicle from scratches when you're loading up – and prevents dirt from the vehicle from getting onto your clothes. Practical design – can be secured to shallow boot tub or reversible mat.

RRP £41.53 (incl. VAT)





# Colours and materials

## Non-metallic paint

Standard



149 polar white

## Metallic paints

Standard



197 obsidian black



896 brilliant blue



775 iridium silver



988 diamond silver



796 citrine brown



992 selenite grey



890 cavansite blue

## Special metallic paints

Additional-cost option

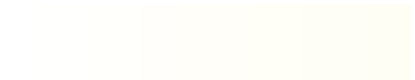

799 designo diamond white bright



996 designo hyacinth red bright



**Leather upholstery**

Standard on AMG Line



211 black



215 ginger beige/espreso brown



224 saddle brown/black



228 crystal grey/black



245 ginger beige/black

**designo Nappa leather upholstery**

Standard on designo Line



954 espreso brown



955 porcelain/black

**AMG Exclusive Nappa leather upholstery**

Standard on Mercedes-AMG GLS 63 4MATIC



531 black with beige stitching



534 espreso brown/black



535 porcelain/black

**Trim**



729 black poplar wood<sup>1</sup>



731 brown burr walnut wood<sup>2</sup>



734 brown eucalyptus wood<sup>3</sup>

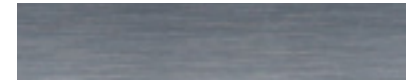

739 brushed light aluminium<sup>2</sup>



H09 brown open-pore ash wood<sup>2</sup>

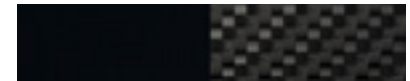

H10 AMG carbon fibre/black piano lacquer<sup>4</sup>



H21 black piano lacquer<sup>4</sup>

<sup>1</sup>Standard <sup>2</sup>No-cost option <sup>3</sup>No-cost option for GLS 350 d only <sup>4</sup>Additional-cost option





# Combination options

		Leather AMG Line					designo Nappa leather designo Line		AMG Exclusive Nappa leather Mercedes-AMG GLS 63 4MATIC		
		black	ginger beige/espresso brown	saddle brown/black	crystal grey/black	ginger beige/black	espresso brown	porcelain/black	black with beige stitching	espresso brown/black	porcelain/black
<b>Non-metallic paint (standard)</b>											
	149 polar white	●	○	●	●	●	●	●	●	●	●
<b>Metallic paints (standard)</b>											
	197 obsidian black	●	○	●	●	●	●	●	●	●	●
	775 iridium silver	●	○	●	●	●	●	●	●	●	●
	796 citrine brown	●	○	△	○	●	△	●	●	△	●
	890 cavansite blue	●	△	○	●	○	△	●	●	○	●
	896 brilliant blue	●	△	○	●	○	△	●	●	○	●
	988 diamond silver	●	○	●	●	○	●	●	●	●	●
	992 selenite grey	●	○	●	●	●	●	●	●	●	●
<b>Special metallic paints (additional-cost option)</b>											
	799 designo diamond white bright	●	●	●	●	●	●	●	●	●	●
	996 designo hyacinth red bright	●	△	△	●	○	△	●	●	△	●

● Recommended ○ Possible △ Not recommended Please note that, owing to limitations of on-screen representation, paint colours may differ from those shown



# Technical data

		Diesel engine	Petrol engine
<b>Model</b>		GLS 350 d 4MATIC	Mercedes-AMG GLS 63 4MATIC
<b>Engine</b>			
Total displacement	cc	2,987	5,461
Arrangement/cylinders/valves		V/6/24	V/8/32
Power <sup>1</sup>	hp (kW) at rpm	258 (190)/3,400	585 (430)/5,500
Torque <sup>1</sup>	Nm at rpm	620/1,600–2,400	760/1,750–5,250
<b>Transmission</b>			
9G-TRONIC 9-speed automatic		●	–
AMG SPEEDSHIFT PLUS 7G-TRONIC 7-speed automatic		–	●
<b>Performance</b>			
Acceleration 0–62 mph	sec	7.8	4.6
Top speed	mph	138	155 <sup>2</sup> (168 <sup>3</sup> )



Model	Diesel engine	Petrol engine
	GLS 350 d 4MATIC	Mercedes-AMG GLS 63 4MATIC

**Weights and capacities**

Kerb weight <sup>4</sup>	kg	2,455	2,580
Perm. Gross Vehicle Weight	kg	3,250	3,290
Towing capacity – unbraked	kg	750	750
braked		3,500	3,290
Boot capacity – behind 1st row of seats	l	2,300	2,300
behind 2nd row of seats		680	680
behind 3rd row of seats		295	295
Fuel tank capacity/of which reserve	l	100/12	100/14
Turning circle	m	12.4	12.4
Wading depth – standard	mm	500	tba
with Off-Road package range		500–600	

**Fuel consumption<sup>5,6</sup>**

mpg

Urban	34.5	17.9
Extra-urban <sup>7</sup>	39.2	27.4
Combined	37.2	23.0



	Diesel engine	Petrol engine
<b>Model</b>	GLS350 d 4MATIC	Mercedes-AMG GLS 63 4MATIC
<b>CO<sub>2</sub> emissions<sup>6</sup></b>	g/km	
Emissions standard	EU6	EU6
21" alloy wheels	199	288
<b>Insurance</b>		
Group rating	50	50
Insurance ratings may vary depending on model line and specification. Please refer to <a href="http://www.thatcham.org/abigrouprating/">http://www.thatcham.org/abigrouprating/</a> for further details		

<sup>1</sup>Figures according to Directive 80/1269/EEC in the currently applicable version

<sup>2</sup>Electronically limited

<sup>3</sup>In conjunction with optional AMG Driver's package

<sup>4</sup>Figures according to Directive 92/21/EC (kerb weight with fuel tank 90% full, driver, 68 kg, and luggage, 7 kg) for standard-specification vehicles

<sup>5</sup>All figures are based on a standard specification with the smallest tyre size

<sup>6</sup>The choice of wheels and transmission may affect CO<sub>2</sub> emissions and corresponding Road Fund Licence

<sup>7</sup>EUDC: extra-urban driving cycle. Testing procedures adhere to EU Directive 93/116





> View offers



Book a > test drive > AMG test drive



> Find a Retailer



> View the Range Guide

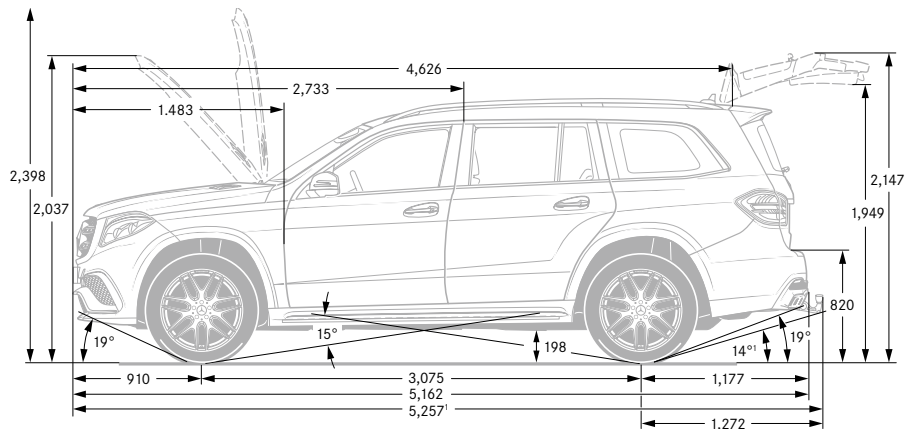
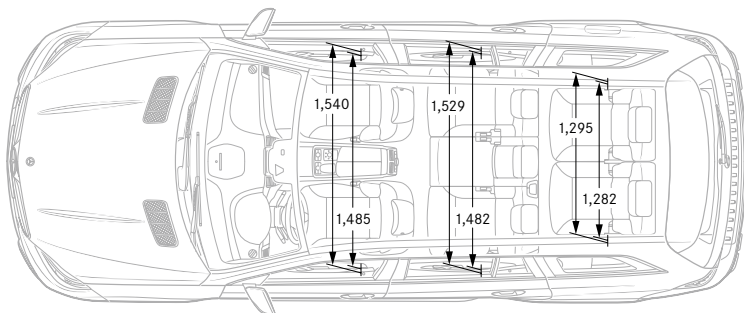
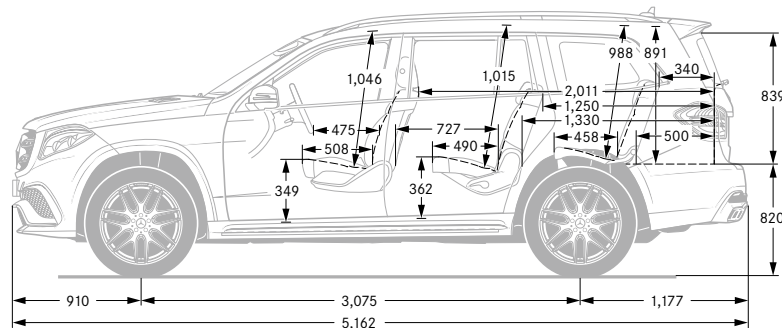
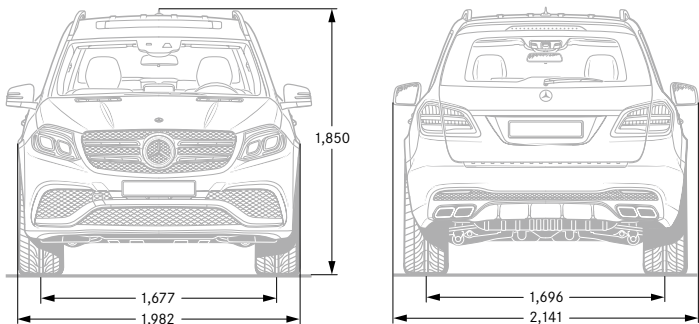

The figures on pages 54–58 are correct at time of publication. Please refer to the government website for latest data – <http://carfueldata.direct.gov.uk/>  
All measurements in millimetres. The dimensions shown are mean values and apply to standard-specification, unladen vehicles



> View offers



Book a > test drive > AMG test drive



> Find a Retailer



> View the Range Guide

# Load space dimensions

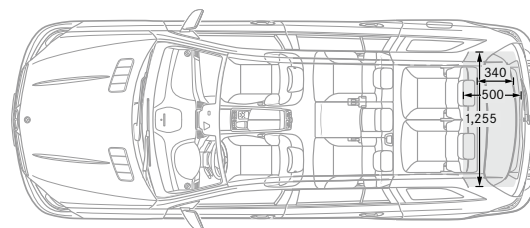
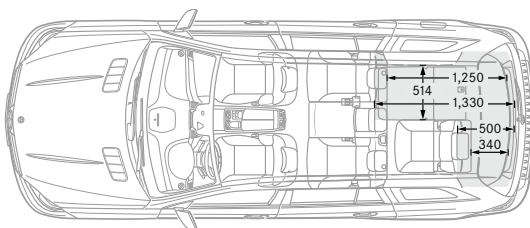
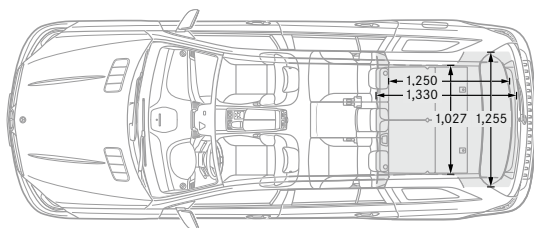
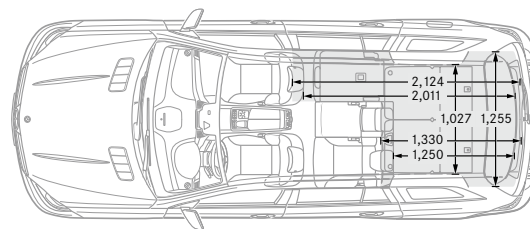
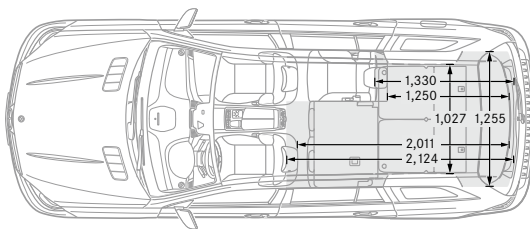
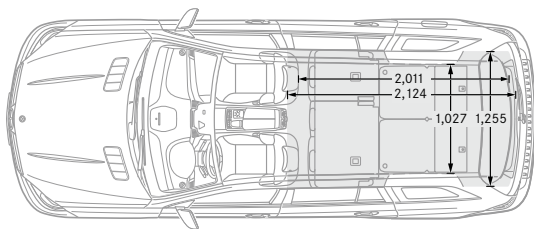

All measurements in millimetres. The dimensions shown are mean values and apply to standard-specification, unladen vehicles



## Road Fund Licence



All road vehicle registrations are subject to Vehicle Excise Duty (Road Fund Licence), which varies in accordance with the vehicle's CO<sub>2</sub> emissions. A first year rate for each taxation band will apply. The table below shows the bands (A–M) created by the DVLA and the corresponding Road Fund Licence. CO<sub>2</sub> emissions are listed in the technical data on page 56, and the relevant Excise Duty is reflected in the on-the-road prices on page 14.

Band	CO <sub>2</sub> emissions	First year rate (£)	Standard rate (£)	Premium rate (£) <sup>1</sup>
A	0 g/km	0.00	0.00	310.00
B	1 to 50 g/km	10.00	140.00	450.00
C	51 to 75 g/km	25.00	140.00	450.00
D	76 to 90 g/km	100.00	140.00	450.00
E	91 to 100 g/km	120.00	140.00	450.00
F	101 to 110 g/km	140.00	140.00	450.00
G	111 to 130 g/km	160.00	140.00	450.00
H	131 to 150 g/km	200.00	140.00	450.00
I	151 to 170 g/km	500.00	140.00	450.00
J	171 to 190 g/km	800.00	140.00	450.00
K	191 to 225 g/km	1,200.00	140.00	450.00
L	226 to 255 g/km	1,700.00	140.00	450.00
M	over 255 g/km	2,000.00	140.00	450.00

Some of the model features, optional extras and colours shown may not be available or may only be available in a different specification.

<sup>1</sup>Premium rate only applicable to vehicles where the list price is over £40,000 including any factory-fitted options, standard UK delivery charge, number plates, fuel and VAT



> View offers



Book a > test drive > AMG test drive



> Find a Retailer



> View the Range Guide

# Services and insurance

## Mercedes-Benz Service Care

We believe that servicing costs should be as flexible and affordable as possible for your GLS, which is why we offer Service Care, an easy way to budget for all your servicing costs. It spreads your bills into manageable payments based on whether you have a new or used Mercedes-Benz.

With Service Care we guarantee the price of parts and labour for up to three services and safeguard against any further inflation. It also covers the cost of all recommended service items including brake fluid, spark plugs, air filters, fuel filters and screen wash.

You can choose either to add your servicing costs into your monthly spend or pay the full amount in a one-off payment, giving you peace of mind that they are taken care of for the period of the plan.

To receive a personalised Service Care plan recommendation visit the Service Care Calculator at [servicecarerates.mercedes-benz.co.uk](http://servicecarerates.mercedes-benz.co.uk)

## Warranty and breakdown cover

Every Mercedes-Benz comes with a three-year unlimited mileage warranty against manufacturing or material defects<sup>1</sup> and up to 30 years warranty against perforation due to corrosion from the inside out.<sup>2</sup> What's more, it's also covered by Mercedes-Benz Roadside Assistance – a unique package comprising up to 30 years pan-European breakdown assistance.<sup>2</sup>

## Insurance

Since our name is synonymous with reliability, who better to trust with your motor insurance? Mercedes-Benz Insurance provides a motor insurance policy specifically designed to give you the cover you would expect from Mercedes-Benz. For a motor insurance quotation, call **0345 600 2180**.\*

<sup>1</sup>Applies to vehicles sold by Mercedes-Benz in the UK to its franchised Retailers <sup>2</sup>Subject to full Terms and Conditions, dependent on date of registration, available upon request Mercedes-Benz Motor Insurance is underwritten by Aviva Insurance UK Limited. Credit provided, subject to status, by Mercedes-Benz Financial Services UK Ltd, MK15 8BA \*For joint protection, calls may be recorded and/or monitored. All calls charged at local rate. We may decline to quote in some circumstances



> View offers



Book a > test drive > AMG test drive



> Find a Retailer



> View the Range Guide

# Mercedes me connect

Mercedes me connect enables you to connect to your car via desktop, tablet or smartphone via an app. It provides access to services that enhance your Mercedes-Benz experience and fit effortlessly into your daily digital routine.

## Standard Services.

Available on all models, except G-Class.

- **Emergency Call** – if there’s an accident, this feature automatically shares your vehicle location and status for a fast response from the emergency services
- **Accident & Breakdown Management** – contact our Customer Assistance Centre with a single button for fast breakdown recovery
- **Telediagnosics** – automatically detects and shares details of any vehicle wear and tear with you, and shares the data with your Retailer
- **Maintenance Management** – reminds you when your service is due and automatically shares maintenance data with your Retailer
- **Parking Time Assist** – track the time on your parking meter and receive an alert when it’s due to expire



## Vehicle Setup.

These services come as standard if you have COMAND Online. Available as an optional £69 upgrade for all other customers.

- **Personal Profile** – store your preferences, such as your favourite radio stations and apps, to create your personal driver profile
- **Maintenance (Vehicle Status)** – check safety information, such as coolant level and brake pad condition, so you can be sure your car is safe and ready to drive
- **Remote Door Unlock** – lock and unlock your car remotely, wherever you are in the world
- **Send to Car Function** – search for destinations on your smartphone, tablet or desktop, then send the routes direct to your car for navigation



> View offers



Book a > test drive > AMG test drive



> Find a Retailer



> View the Range Guide

## Remote Online Services.

Standard on all models with COMAND Online, except for new E-Class. Available to purchase for an additional £150.00 (incl. VAT) for all models without COMAND Online.

- **Trip information and vehicle status** – access the vehicle's trip data such as fuel level, mileage, condition of brake pads and tyre pressure
- **Remote door locking and unlocking** – lock and unlock your car remotely, wherever you are in the world
- **Geofencing** – set up a geographical boundary and receive alerts whenever your car enters or leaves this area
- **Parked Vehicle Locator** – locate your parked vehicle within a range of one mile and plot a route back to it
- **Vehicle Tracker** – track the location of your car anywhere in the world

**Additional services for Plug-In Hybrid and electric models only, as part of Remote Online services:**

- **Pre-entry climate control** – activate the pre-entry climate control system of your parked vehicle and set the temperature to your liking before boarding
- **Route planning** – displays the electric operating range on a map and enables you to plan a route while stopping at public charging stations
- **Charging points** – displays a list of the nearest public charging stations
- **Charging profile** – control the charging settings from a distance so your vehicle can be ready charged when you need it

## Vehicle Monitoring.

Standard with COMAND Online for all models, except the new E-Class. Available to purchase for new E-Class and all other customers as an additional £69 upgrade.

- **Geo-fencing** – set up a geographical boundary and receive alerts whenever your car enters or leaves this area
- **Parked Vehicle Locator** – locate your parked car when within 1 mile and plot a route back to it
- **Vehicle Tracker** – track the location of your car anywhere in the world

Visit the Mercedes me connect store for more information:

[shop.mercedes-benz.com/en-gb/connect](http://shop.mercedes-benz.com/en-gb/connect)

# Mercedes-Benz Finance

## Why should you finance with Mercedes-Benz?

At Mercedes-Benz we believe a great driving experience should be matched by an equally great ownership experience. That is why we put just as much thought, time and effort into designing our finance options, our service plans and our insurance cover as we do into our vehicles.

We are not in the business of simply providing a loan to fund the purchase of your dream vehicle. We look on it as a journey that we take with you, from the moment you choose your new Mercedes-Benz, to helping you in choosing your next one.

If you would like to find out more about any of our current offers, simply call into your local Mercedes-Benz Retailer where one of our Business Managers will be more than happy to talk you through anything you need to know.

## Helping you find the right solution.

You should find our finance packages are more convenient than a traditional personal loan because:

- Funds are immediately available – no waiting for cheques or loans to clear.
- There is no security required – either against your home or other assets.
- We have clear and transparent rates – the APR we quote is the APR you get.
- We have friendly Business Managers – experts in vehicle finance who can talk you through all of your plans in detail.

One of our most popular finance products is Mercedes-Benz Agility (our Personal Contract Purchase product). We also offer Contract Hire, Operating Lease and Hire Purchase solutions. If you would like to find out more about these speak to your Retailer or visit [www.mercedes-benz.co.uk/fandi](http://www.mercedes-benz.co.uk/fandi).

## Mercedes-Benz Agility (our PCP product).

At the start of an Agility agreement, you put down a deposit and decide the term of your agreement and your annual mileage. You will be advised of the Guaranteed Future Value, which offers you the reassurance of knowing exactly what you will need to pay to own the vehicle outright in the future (this is known as the Optional Purchase Payment).

Throughout your agreement you simply pay your agreed monthly payments and when the agreement comes to an end you either purchase, hand back or part-exchange your vehicle.





### Agility features:

- Fixed regular payments mean you can easily budget.
- Payments are based only on a proportion of the vehicle's value, keeping your monthly payments lower.
- Our Guaranteed Future Value avoids the risk of unplanned depreciation of your vehicle.
- You defer your ownership decision until the end of the agreement.

### At the end of your agreement you have three options to choose from.

#### Option 1: Purchase your Mercedes-Benz.

Purchase your Mercedes-Benz by paying the Optional Purchase Payment and Purchase Activation Fee.<sup>1</sup> This will complete the purchase of your Mercedes-Benz, leaving you free to simply enjoy your vehicle.

#### Option 2: Hand back your Mercedes-Benz.

If you decide to return your vehicle to us, it must be in line with our Vehicle Return Standards,\* as vehicle condition, excess mileage and other charges may be payable.

#### Option 3: Part-Exchange for a new vehicle.

Purchase your Mercedes-Benz by paying the Optional Purchase Payment and Purchase Activation Fee.<sup>1</sup> This will complete the purchase of your Mercedes-Benz, leaving you free to part-exchange for a new vehicle.

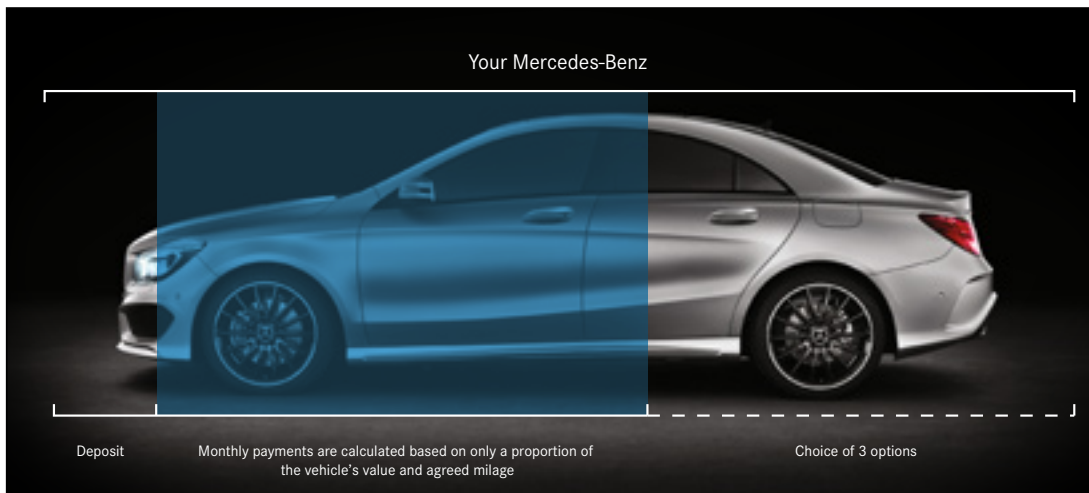

<sup>1</sup>Please note the 'Purchase Activation Fee' of £10 will be debited from your account \*To find out more information about our Vehicle Return Standards please visit <http://mercedes-benz.co.uk/vrs>





> View offers



Book a > test drive > AMG test drive





> Find a Retailer





> View the Range Guide

Follow us on the following social media channels:

 [facebook.com/mercedesbenzuk](https://facebook.com/mercedesbenzuk)

 [twitter.com/mercedesbenzuk](https://twitter.com/mercedesbenzuk)

 [youtube.com/mercedesbenzuk](https://youtube.com/mercedesbenzuk)

 [instagram.com/mercedesbenzuk](https://instagram.com/mercedesbenzuk)

Effective from 21 June 2017 Production. Information correct at time of publication.

Prices and specifications are subject to change without prior notice.

MBX166PL/0517

Mercedes-Benz Cars UK Limited, Tongwell, Milton Keynes, MK15 8BA. Company number 2448457 [www.mercedes-benz.co.uk](http://www.mercedes-benz.co.uk)