

Mercedes-Maybach S-Class

Effective from 21 March 2017 Production.



Mercedes-Benz





Impressive spaciousness, elegant design and high-quality materials create an unparalleled ambience, particularly in the rear. Characterised by exquisite materials using excellent handcrafting skills, the Mercedes-Maybach S-Class epitomises exclusivity and luxury.

For more information visit www.mercedes-benz.co.uk or call 0333 222 0500.

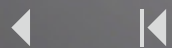

Contents

Model prices	4
Mercedes-Maybach S 600 – Exterior	5
Wheel choices	8
Mercedes-Maybach S 600 – Interior	9
Upholstery and trim choices	12
Standard equipment	19
Driving Assistance package	24
First Class Cabin package	25
designo Leather package	27
Mercedes-Maybach Genuine Accessories	28
Mercedes-Maybach Collection	29
Colour choices	31
Trim and upholstery combinations	34
Technical data and dimensions	35
Services and insurance	38



Model prices



Mercedes-Maybach S 600

Petrol – 5,980 cc, 12-cylinder, 530 hp/390 kW,
Transmission 7G-TRONIC PLUS, CO₂ 274 g/km

**Basic RRP
excl. VAT**
£141,308.33

**Total RRP
incl. VAT**
£169,570.00

**Vehicle Excise Duty (RFL)
Band M first year rate¹**
£2,000.00

**Rec. OTR
price²**
£172,285.00

**P11D
value**
£170,230.00

**BiK tax rate
2017/18**
37%

**Vehicle Excise Duty (RFL)
Band M premium rate**
£450.00

¹A different first year rate of Vehicle Excise Duty (Road Fund Licence) applies for new cars number plates (£25.00 incl. VAT). VAT is calculated at the standard rate of 20%

²The recommended on-the-road price includes the Road Fund Licence applicable to the standard model plus delivery charge (£635.00 incl. VAT), new vehicle registration fee (£55.00) and



Mercedes-Maybach S 600 – Exterior

The exterior design of the Mercedes-Maybach S-Class combines stylish poise and assurance with trailblazing exclusivity. The dramatic exterior lines convey an impression of power and dynamism. The prominent front end immediately asserts the Mercedes-Maybach S-Class's ambition to lead. The striking bonnet and sharply

defined headlamp contours accentuate the high-tech character of the car. The elegant looks of the Mercedes-Maybach S-Class are emphasised by the three twin louvres of the radiator trim in chrome.

Closing aid for doors and boot lid

When initially engaged, doors and boot lid are automatically closed by servo motors, ensuring smooth and virtually silent closing

Doorhold system

Door mirrors – electrically operated, folding and heated

Exhaust system – with twin visible chrome-plated tailpipes

Headlamps – LED Intelligent Light System

LED headlamps with variable light distribution for country roads and motorways, Active Light System, cornering light function, extended fog light function and Adaptive Highbeam Assist

Heat-insulating, noise-insulating and infrared-reflecting laminated glass

KEYLESS-GO Comfort package – KEYLESS-GO, remote boot closing and hands-free access

Vehicle can be conveniently unlocked, started and locked, simply by carrying an electronic key. In addition, the convenient hands-free access function allows hands-off, fully automatic opening and closing of the boot lid by performing a kicking motion under the rear bumper – particularly useful when laden with luggage

LED rear lamps

MAGIC VISION CONTROL

Allows the driver the best possible visibility even during the wiping process. Washer fluid is sprayed directly in front of the wiper blades and wiped away without delay. A heating system effectively lowers the risk of icing up

Panoramic sliding roof with MAGIC SKY CONTROL

Large panoramic roof changes from dark to transparent or vice versa within a few seconds. In its tinted state, it substantially reduces heating-up of the vehicle interior

Parking package – Active Parking Assist with PARKTRONIC and 360° camera

PARKTRONIC monitors front and rear while vehicle is being manoeuvred and warns the driver if risk of collision is detected. Active Parking Assist helps find appropriate parking slots and can also automatically manoeuvre the car in and out of perpendicular and parallel parking spaces

Privacy glass – from side windows of rear B-pillar round to rear window

Rear fog lamp in LED technology, in the centre of the rear apron

Remote boot lid release

Run-flat tyres

Speed-sensitive steering with variable steering ratio

'V12' lettering on front wings

Windscreen wipers including rain sensor with two sensitivity stages







Mercedes-Maybach S 600 exterior

Exhaust system - with twin visible chrome-plated tailpipes

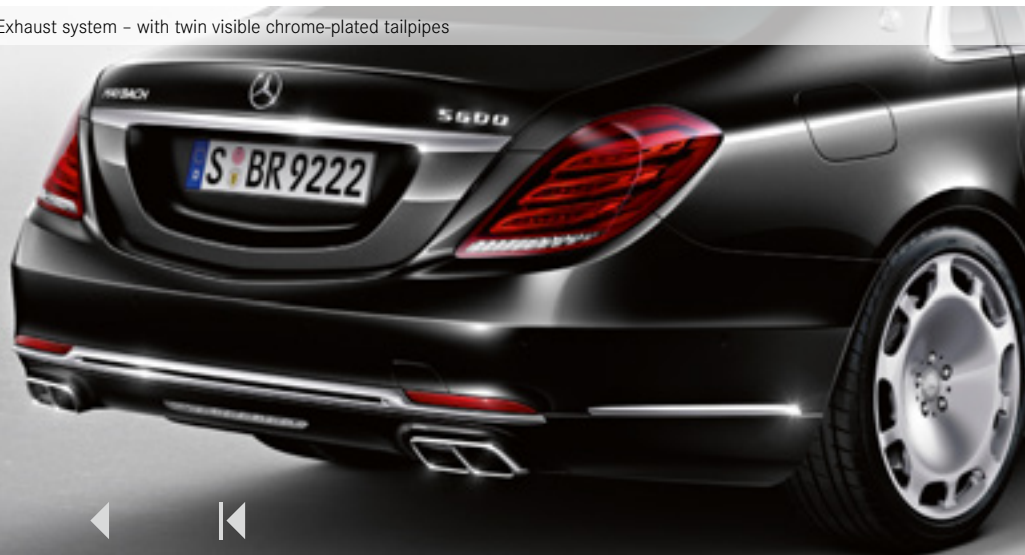

Privacy glass - from side windows of rear B-pillar round to rear window

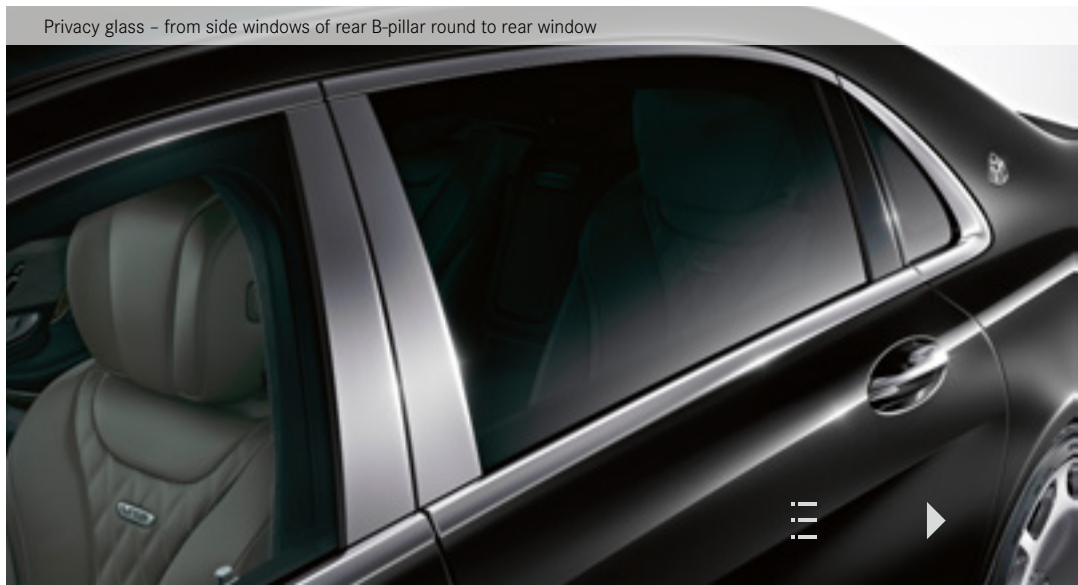

Wheel choices

Choose between 20" multi-spoke alloy wheels painted in thulium silver or high-gloss polished ceramic; or, instead of delicate spokes, exclusive 20" forged alloy wheels (available at no additional cost), which underline the flagship model's high-quality look.



20" multi-spoke alloy wheels painted in thulium silver (code 13R)



20" 5-spoke alloy wheels painted in thulium silver (code 53R)



20" multi-spoke alloy wheels in high-gloss polished ceramic (code R28)



20" forged alloy wheels (code 67R)

20" alloy wheels (4) (code 13R) - standard

Multi-spoke design painted in thulium silver
front: 245/40 R20 tyres, rear: 275/35 R20 tyres

20" alloy wheels (4) (code R28) - no-cost option

Multi-spoke design in high-gloss polished ceramic
front: 255/40 R20 tyres, rear: 285/35 R20 tyres

20" alloy wheels (4) (code 53R) - no-cost option

5-spoke design painted in thulium silver
front: 245/40 R20 tyres, rear: 275/35 R20 tyres

20" alloy wheels (4) (code 67R) - no-cost option

Forged alloy wheels
front: 245/40 R20 tyres, rear: 275/35 R20 tyres



Mercedes-Maybach S 600 – Interior

The interior of the Mercedes-Maybach S-Class indulges its passengers with a luxurious atmosphere of well-being. The cockpit of the Mercedes-Maybach S-Class impresses with its sophisticated, uncluttered design, an innovative control and display concept, and craftsmanship showing unerring attention to detail. Occupants of the

Mercedes-Maybach S-Class travel in unsurpassed comfort, relaxation and safety. Apart from ensuring excellent support, the luxurious seats offer six different massage settings. Memory functions for seats and headrests, as well as steering column and exterior mirrors can be stored and recalled at the touch of a button.

12V sockets (4) – one in front and two in rear of centre console, and one in boot

AIR-BALANCE package

Five premium scents are available to provide an individual atmosphere to suit your mood and taste. At the same time, a unique ionising and filtering process helps to enhance the air quality inside the cabin.

The five fragrances for the AIR-BALANCE package are: AGARWOOD (exclusively for Mercedes-Maybach S-Class), NIGHTLIFE MOOD, DOWNTOWN MOOD, SPORTS MOOD and FREESIDE MOOD

Ambient lighting – choice of seven colour settings

Analogue clock

Ashtray and cigarette lighter

Removable inserts transform the two stowage compartments in the front and rear areas of the centre console into ashtrays with covers. The feature is rounded off by two cigarette lighters

Climatised front and rear seats including seat heating and ventilation

Cup holders – front (2) and rear (2)

Electric roller sun blinds – rear window and rear side windows

Electric windows (4) with PRE-SAFE® closing function

Floor mats (4) – velour floor mats with ‘V12’ emblem

Replaced with designo floor mats when ordering the designo Exclusive semi-aniline leather

Front and Rear Seat Comfort package

Provides optimum lateral support by means of individually controlled air chambers which inflate depending on steering angle, lateral acceleration and vehicle speed. Massage function has six different programmes, with a choice of low- or high-intensity settings

Front and Rear Seat Memory package

Front seats, two outer rear seats, front head restraints, steering column and exterior door mirrors – electrically adjustable with memory and four-way lumbar support

Front centre armrest with embossed Maybach emblem

Diamond quilting replaces the embossed Maybach emblem when ordering the designo Exclusive semi-aniline leather

Garage door opener – integrated in rear-view mirror

For questions regarding compatibility please visit www.homelink.com

Glasses stowage compartment

Glove compartment – lockable, air-conditioned and illuminated

Illuminated door sill panels with ‘MAYBACH’ lettering

Illuminated vanity mirrors in rear

Map pockets on front and rear backrests

Parcel nets in boot and front passenger footwell

Reading lamps – front and rear

Rear armrest including stowage compartment with cover

Replaced by Business Console which extends from the front centre console through to the parcel shelf when ordering the optional First Class Cabin package







High-gloss brown burr walnut wood trim with analogue clock



Illuminated door sill panels with 'MAYBACH' lettering



Rear seat entertainment system

Rear Seat Reclining package

EASY ADJUST luxury front head restraints; front seats with extended adjustment; reclining outer rear seats (up to 43.5°) and additional leg rest and footrest

Rear sill protector in stainless steel

Service indicator ASSYST

Steering column – electrically adjustable with EASY-ENTRY function

Steering wheel – 2-spoke wood/leather multi-function steering wheel with 'MAYBACH' lettering

Sun visors with illuminated vanity mirrors

THERMOTRONIC two-zone automatic climate control in the front
Three different climate modes: Focused, Medium and Diffuse

THERMOTRONIC two-zone automatic climate control in the rear

Trip computer in multi-function display showing current fuel consumption

Warmth Comfort package

Heatable armrests in front and rear; heated multi-function steering wheel

Widescreen cockpit consisting of an Instrument Display and Media Display

Upholstery and trim choices

designo

The high-quality standard of the Mercedes-Maybach S-Class is impressively demonstrated in the material selection of the interior. There is the option to choose between designo Exclusive semi-aniline leather or Exclusive nappa leather.

designo Exclusive semi-aniline leather features

designo badge in the backrests of front and rear seats

designo velour floor mats with designo badge

Centre part of dashboard partially finished in quilted diamond pattern in silk beige nappa leather

Front and rear centre armrests in nappa leather with diamond quilting (rear only with First Class Cabin package)

Seat upholstery layout featuring an exclusive diamond design on the entire seat centre section upholstery buttons and Budapest piping

Upper part of the dashboard and beltlines in nappa leather with piping and contrasting topstitching

Exclusive nappa leather features

Front and rear centre armrests in nappa leather with contrasting topstitching

Seat upholstery layout with diamond design and contrasting topstitching

Upper section of instrument and door centre panels in nappa leather with contrasting topstitching

'V12' badge in the backrests of front and rear seats

Velour floor mats

Upper section of instrument panel and door centre panels in nappa leather



Exclusive nappa leather silk beige/espresso brown



Upholstery choices – designo Exclusive semi-aniline leather



designo Exclusive semi-aniline leather in silk beige/satin red pearl (code 975)¹



designo Exclusive semi-aniline leather in silk beige/titanium grey pearl (code 965)¹

It takes just a few carefully chosen ingredients to turn your Mercedes-Maybach S-Class into an individual work of art. designo Exclusive semi-aniline leather upholstery in silk beige combined with satin red pearl or titanium grey pearl adds to a truly luxurious look. Both colour options are available at no additional cost.

All choices feature a quilted diamond pattern repeated in the centre section of the dashboard, seats in designo Exclusive semi-aniline leather with diamond design detail to the entire seat centre section, upholstery buttons, Budapest piping and designo badges.

Please note that the upholstery imagery shown here features individual seats in the rear. These are part of the optional First Class Cabin package. The standard seating arrangement in the rear is a three seat bench.

designo

¹Not in conjunction with designo metallised ash wood trim (code H06)



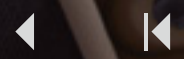

Upholstery choices - Exclusive nappa leather

Exclusive nappa leather makes an especially soft impression due to its smooth and natural surfaces; giving the interior that 'feel-good' factor. Exclusive nappa leather is available in five attractive colour options at no additional cost.



Exclusive nappa leather in black/black (code 501A)



Exclusive nappa leather in silk beige/espresso brown (code 505A)¹



¹Not in conjunction with designo metallised ash wood trim (code H06)





Exclusive nappa leather in crystal grey/seashell grey (code 508A)



Exclusive nappa leather in nut brown/black (code 514A)¹



Exclusive nappa leather in porcelain/black (code 515A)



Trim choices

Add eye-catching highlights to your Mercedes-Maybach S-Class, thanks to a carefully selected range of high-quality light and dark wood trims as well as designo black piano lacquer. All trim choices are available as a no-cost option.



designo black piano lacquer (code H21)



designo metallised ash wood (code H06)¹



designo brown high-gloss sunburst myrtle wood (code 727)

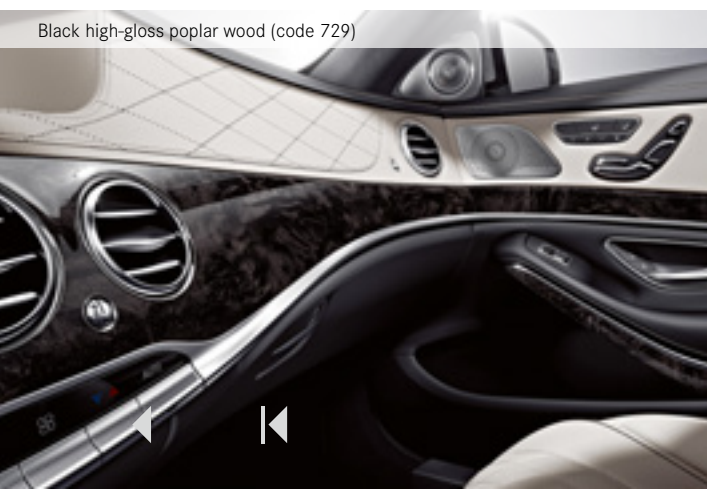

Black high-gloss poplar wood (code 729)



High-gloss burr walnut wood in brown (code 731)

¹Available with the following upholstery only:
 Exclusive nappa leather in black/black (code 501A)
 Exclusive nappa leather in crystal grey/seashell grey (code 508A)
 Exclusive nappa leather in porcelain/black (code 515A)





designo piano lacquer flowing lines black (code H16)

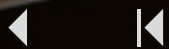

AUTO

Standard equipment

The term ‘standard’ hardly befits Mercedes-Maybach’s level of equipment. It’s hard to find a limousine with such a high degree of comfort and safety. The seats incorporate a wealth of features for your wellbeing. They are designed to offer the best support and maximum relaxation thanks to climatisation, as well as a Front and Rear Seat Comfort package. The two outer rear seats can be reclined up to 43.5°.

For an even brighter atmosphere inside the cabin, there is a panoramic sliding roof with MAGIC SKY CONTROL. All the while, the Burmester® high-end 3D surround sound system, TV tuner and TV rear entertainment system with two 10-inch screens, DVD player and wireless headphones answer all your audiovisual needs.

Transmission and Suspension

7G-TRONIC PLUS 7-speed automatic transmission with steering column gear selector, DIRECT SELECT steering wheel gearshift paddles and SPEEDTRONIC cruise control

Direct Steering

ECO start/stop function

MAGIC BODY CONTROL

This suspension system offers another milestone in driving comfort, detecting bad road surfaces in advance and reacting accordingly. The active damping system of the suspension works with a road surface scan to achieve this. A stereo camera captures a detailed picture of the conditions ahead which is then analysed to allow the system to decide how best to dampen each individual wheel to compensate for any uneven surfaces ahead – all in a split second

Paint, Trim and Upholstery

Metallic paint

Trim – designo black piano lacquer

Upholstery – Exclusive nappa leather

Upholstery – Exclusive Nappa Leather package

Armrests and lining of centre console in nappa leather with contrast stitching

Colour-contrast fluting on beltline

DINAMICA microfibre roof lining

Door panels with hand-stitched facings in nappa leather

Exclusive nappa leather upholstery

Extended trim parts: additional wood trim in door centre panels and rear air vent covers

Nappa leather upper dashboard with diamond-pattern perforations and contrast stitching

Perforated diamond pattern in continuation of front door armrests and in rear door seat function control panels

Seats in diamond pattern nappa leather with contrast stitching

Seats in diamond pattern nappa leather with contrast stitching

Security and Safety

Active bonnet – pedestrian safety measure

Adaptive brake lamps

ADAPTIVE BRAKE system

Including HOLD function, Hill-Start Assist, brake priming and dry braking in wet conditions

Airbags – driver and front passenger

Airbags – front and rear sidebags

Airbags – windowbags

Alarm system with immobiliser and interior protection (MBSS3)

Anti-lock braking system (ABS) with Brake Assist (BAS)

ATTENTION ASSIST – monitors steering and can help alert to long journey fatigue

Continuously analyses driver behaviour and steering movements. If patterns are recognised which characterise drowsiness, the driver is prompted to take a break, and an audible warning is sounded. At the same time COMAND Online offers to locate a rest stop





Embossed Maybach emblem on centre armrest



Exclusive Nappa leather upholstery with contrast stitching



Front Seat Memory package

Panoramic sliding roof with MAGIC SKY CONTROL



Night View Assist Plus



Burmester® high-end 3D surround sound system speakers



Security and Safety (continued)

Automatic child seat recognition (ACSR) on front passenger seat for child seats with transponder specially approved by Mercedes-Benz

Automatically dimming rear-view mirror and driver's exterior mirror

Brake Assist (BAS) with brake servo assistance when emergency braking is detected

Brake pad wear indicator

Crosswind Assist

Detects sudden, strong gusts of wind and helps the driver stay in lane by means of targeted braking

Electric parking brake

Electronic Stability Programme (ESP®) with Acceleration Skid Control (ASR)

ESP® Curve Dynamic Assist

Especially when accelerating on bends, ESP® can ensure improved handling by detecting understeer and effecting a remedy through braking intervention

First-aid kit

Front passenger seat with PRE-SAFE® positioning function

Headlamp Assist – automatic headlamp activation

Head restraints, rear (3) – outer two, electrically adjustable

Intelligent Rear Seat Belts package

Illuminated seat belt buckle extenders facilitate seat belt fastening on outer rear seats

Inflatable three-point seat belts with integrated belt bags on outer seats

i-Size and ISOFIX child restraint system (two outer seats)

Locking wheel bolts

Night View Assist Plus

Enables drivers to recognise pedestrians or larger animals earlier in the dark. They are clearly shown on the multifunction display of the instrument cluster. To do this the system illuminates the road ahead with two dazzle-free infrared lamps. With the help of an infrared camera located behind the windscreen, the entire area within high beam headlamp range is shown as a crystal-clear greyscale image. A thermal imaging camera in the radiator grille is able to give a precise warning by distinguishing between irrelevant objects such as traffic sign combinations or bushes and relevant objects such as pedestrians or large animals. The latter are highlighted in colour by small 'photo mounts'. The Spotlight function enables endangered pedestrians to be flashed at several times, so that the driver registers them even more quickly and the former recognise the danger

PRE-SAFE® anticipatory safety system

PRE-SAFE® Impulse

In the early phase of a crash, the front occupants are pulled away from the direction of impact and deeper into their seats by their seat belts

Rain-sensing wipers – two-stage

Rear seat belt status indicator

Remote central locking

Seat belts, rear (3) – three point

Seat belt pre-tensioners, belt force limiters and automatic belt height adjustment – front and outer rear seats

Traffic Sign Assist

The front-mounted camera detects speed limit warnings, no-overtaking signs and their cancellation, and shows them in the COMAND display. If a no-entry sign is detected and the driver disregards this, the systems emits a visual and acoustic warning as part of the no-entry warning function

Tyre pressure monitoring system

Warning triangle

Communications and In-Car Entertainment

Bluetooth® interface with high-definition call quality for hands-free telephony

Burmester® high-end 3D surround sound system
24 speakers and 24-channel amplifier with total output of 1,520 W

Central controller dial to operate audio functions and telephone (when connected)



12.3-inch colour display



Head-up display



MAGIC VISION CONTROL – adaptive windscreen wiper system



Touchpad and COMAND Online controller



Mercedes connect me

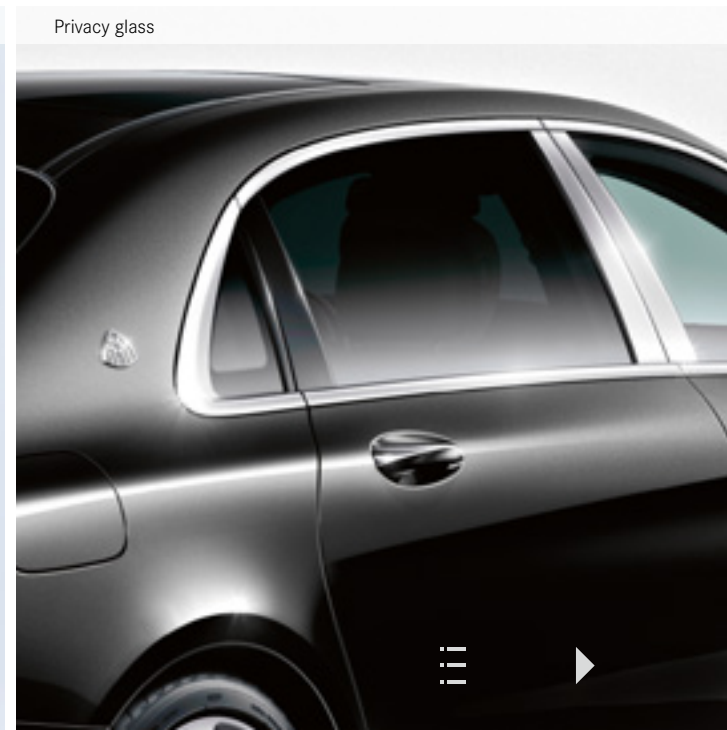

Privacy glass

Communications and In-Car Entertainment (continued)

COMAND Online system with Media Interface

Includes radio, CD/DVD player with 6-disc changer, 12.3-inch colour display, hard disk drive (HDD) navigation with 3D map display, Live Traffic Information and European map data updates free of charge for the first three years, Speed Limit Assist and LINGUATRONIC voice control. Integrated WLAN hotspot for onboard access of WLAN-enabled devices. Also includes SD memory card slot, 10 GB music register and MP3 compatibility. Media Interface allows connection and control of portable media devices (e.g. MP3 player, USB storage media)

COMAND Online remote control

DAB digital radio tuner

Digital operating instructions for COMAND Online

Head-up display – key driver information at a glance

A virtual image (approx. 21×7 cm) is projected into the driver's field of view, appearing to float above the bonnet approx. 2 m ahead. Both display height and content can be adjusted individually, while the information shown can be activated and deactivated according to your preference

Mercedes-Benz emergency call system (eCall)

Mercedes me connect (standard services)

Including emergency call system (eCall), accident recovery, breakdown management and maintenance management; Mercedes-Benz apps and in-car internet access for Facebook, internet radio, sending routes from Google Maps™ to the vehicle, news and weather reports; internet-enabled mobile phone required

Rear seat entertainment system

Two 10-inch screens on rear seat backrests, DVD player, two sets of wireless headphones and remote control for COMAND Online system

Rear seat telephony

The handset with touchscreen serves both as a telephone and as a remote control for the seat functions of the Rear Seat Comfort package

SPLITVIEW for COMAND Online system

The 12.3-inch COMAND Online display allows the driver to use the navigation system, while the front seat passenger watches a DVD in high definition. With SPLITVIEW, different content can be viewed on the same screen depending on the seating position and viewing angle. Two different images are displayed simultaneously by adjacent pixels and a filter in front of the display visually divides the mixed images. Headphones provide the front passenger with excellent sound without distracting the driver

Touchpad

TV tuner – with digital reception capabilities

(Discontinued from April 2017 production)

Universal Telephony package

Mobile phones can be conveniently connected to the onboard HD voice-compatible hands-free system via a universal interface in the armrest. To do this the mobile phone is simply inserted into the universal smartphone cradle¹

Voice amplification system

This innovative function makes it easier to communicate with the rear passengers from the front. The two microphones in the interior mirror are also used to pick up speech for the hands-free telephone system. These signals are then discreetly amplified depending on the amount of driving noise, and continuously adjusted for the speaker's volume and the ambient noise level

¹A separate cradle for your mobile phone needs to be ordered as an accessory from your Retailer

Driving Assistance package

The Driving Assistance package (standard) contains a range of highly intelligent features to help you stay safe on the road and protect other road users, by making the drive more effortless, by warning of danger, and by taking steps to protect you in an emergency.

Active Blind Spot Assist

Visible warning in exterior mirrors if vehicle is detected in the blind spot. Audible warning if indicating to move out of lane when a vehicle is detected in the blind spot. If, nevertheless, the driver starts to change lane, the system can give another haptic warning by means of a noticeable course-correcting braking intervention and, if the driver still fails to react, can actively help to manoeuvre the vehicle out of the danger zone

Active Lane Keeping Assist

Vibrates the steering wheel when detecting unintentional drifting out of lane. If the driver does not react, course-correcting braking intervention can actively help to manoeuvre the vehicle back into its lane

BAS PLUS with Junction Assist

Brake Assist System develops additional brake pressure if a critical situation is detected and the driver applies the brakes

DISTRONIC PLUS with Steer Assist and Stop&Go Pilot

Helps the driver automatically maintain a safe distance from the vehicle ahead and relieves strain on long journeys or when following vehicles in a traffic. When necessary, the radar-based system brakes the vehicle and, if possible, returns to preset speed

PRE-SAFE® Brake and PRE-SAFE® PLUS

If the system detects a critical driving situation, preventive occupant protection measures are initiated, including reversible seat belt tensioning, adjustment of passenger seat positions, and closure of windows and panoramic glass sunroof





Champagne flutes



Folding tables in the rear



Refrigerated compartment in rear

First Class Cabin package

Business or pleasure, the First Class Cabin is at your service. Here, both rear seat passengers can work or relax in complete luxury. It also reduces the boot space by 40 litres.

First Class Cabin package (code DA9) – designed and priced as a package, including items as listed
Total incl. VAT £7,300.00

Refrigerated compartment in rear (code 308) – available as a stand-alone option
Total incl. VAT £1,130.00

Champagne flutes

A drive in a quite exceptional vehicle can be celebrated in style with two high quality silver-plated champagne flutes

Folding tables in the rear

With the two high-quality folding tables, the Business Console of the First Class rear suite can be converted into an office desk in seconds. The stowage trays provide space for a notebook or working documents

Individual rear seats

The continuous Business Console transforms the rear into a mobile office. Two 12V sockets and temperature-controlled cup holders make for a comfortable travelling and working environment. The Business Console extends from the front centre console through to the parcel shelf

Refrigerated compartment in rear

Elegantly integrated into the rear armrest and with a capacity of approx. 8.5 litres. Temperature can be set between approx. 4–15° C using two control switches



Individual rear seats

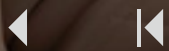



Two MAYBACH cushions in the upholstery colour



designo nappa leather roof liner with topstitching and window frame trim in nappa leather in the upholstery colour

designo Leather package

With high-grade touches of leather in the interior, the designo Leather package sets a luxurious and stylishly coordinated tone – from the instrument panel to the window frame trim and seat cushions to the designo nappa leather roof liner.

designo Leather package (code U6 1) – designed and priced as a package, including items as listed

Total incl. VAT £13,150.00

designo nappa leather roof liner with topstitching

Including leather-covered sunblinds, grab handles and A-, B- and C-pillars

Rear vanity mirrors leather-covered with diamond quilting

Finished in black (71U) in vehicles with interior in black (501A), nut brown/black (514A) or porcelain/black (515A)

Finished in porcelain (75U) in vehicles with interior in silk beige/espresso brown (505A), silk beige/satin red pearl (965A) or silk beige/titanium grey pearl (975A)

Finished in crystal grey (78U) in vehicles with interior in crystal grey/seashell grey (508A)

Front seat consoles on driver and front passenger sides in nappa leather in the upholstery colour

Side instrument panel covers on driver and front passenger sides in nappa leather in the upholstery colour

Two seat cushions in the upholstery colour, two-tone with border in diamond quilting and MAYBACH logo:
Finished in nappa leather with Exclusive nappa leather interior; or in designo Exclusive semi-aniline leather/nappa leather with designo Exclusive semi-aniline leather interior

Window frame trim at front (including triangular tweeters) and rear in nappa leather in the upholstery colour

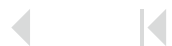

Mercedes-Maybach Genuine Accessories

We've developed a range of Accessories you can add to help personalise and enhance your Mercedes-Maybach S-Class. Your local Mercedes-Benz Retailer can advise on fitting costs of Accessories, where applicable. Further information on our full range of Genuine Accessories can be found on the Mercedes-Benz UK website.

Style & Travel

The 'Style & Travel Equipment' components are simple to attach and remove. The modular system centres around a base support which can be combined with the product of your choice – coat hanger, universal hook or folding table.

Base support **£22.32 (incl. VAT)**

Coat hanger **£67.60 (incl. VAT)**

Champagne flute

Exclusive, solid silver-plated Robbe & Berking champagne flute for insert in the rear centre console

Total RRP £657.00 (incl. VAT)

Flacon perfume atomiser, transparent/black

The interior of the vehicle can be fragranced individually to suit your tastes. There are five high-quality fragrances to choose from, designed to suit your personal preferences and mood: AGARWOOD, DOWNTOWN, NIGHTLIFE, FREESIDE and SPORTS (optional extra Air Balance package required)

Total RRP £56.00 (incl. VAT)

Coat hanger



Champagne flute



Flacon perfume atomiser



Mercedes-Maybach Collection

The Mercedes-Maybach Collection is a range of products bearing the famous Mercedes-Maybach insignia and is designed to the same high standards as our cars. You can expect to find the uncompromising quality and innovation for which Mercedes-Benz is best known in our Collection items. Further information can be found on www.mercedes-benz.co.uk/collection

Business card wallet, black

With its three slip pockets, the black nappa lambskin lends the wallet a refined look with metal stud on the front, featuring the double M logo outlined in black. The back is embossed with MAYBACH lettering. Size approx. 10.5×7.0 cm

Basic RRP £192.08 (excl. VAT) **Total RRP £230.50 (incl. VAT)**

Key ring, black

This high-quality key ring in nappa leather and zamak alloy with MAYBACH lettering offers a strong visual appeal. The harmonious design is rounded off by a three-dimensional metal double M logo on the front

Basic RRP £163.33 (excl. VAT) **Total RRP £196.00 (incl. VAT)**

Cufflinks, black

The Maybach cufflinks are certain to round off your look to perfection. These black accessories in glass on silver rhodium complement any outfit. The design is completed by a sand-blasted double M logo on the front and engraved MAYBACH lettering on the back

Basic RRP £267.00 (excl. VAT) **Total RRP £320.40 (incl. VAT)**

Business card wallet



Key ring



Cufflinks



Blanket, black/anthracite

A luxurious, high-quality and exquisitely soft blanket, made from pure new lambswool in a black and anthracite colour combination. The upper side of the blanket features a leather patch with a three-dimensional metal double M logo and on the underside there is a care label, embossed with the 'MAYBACH ICONS OF LUXURY' logo. Size approx. 1.30×1.90 m
 Basic RRP £654.58 (excl. VAT) **Total RRP £785.50 (incl. VAT)**

Business bag, black

The practical bag in black calfskin offers space for numerous documents and has an attractive look, rounded off with beige topstitching, an embossed double M logo on the front, MAYBACH lettering on the back and four metal studs. It features a two-way zip fastening, and various compartments inside and a pocket for documents outside of the bag. The detachable, adjustable and padded leather shoulder strap ensures optimum carrying comfort. Size approx. 38 × 41 × 10 cm
 Basic RRP £3,442.50 (excl. VAT) **Total RRP £4,131.00 (incl. VAT)**

Holdall, black

The black Maybach holdall in high-quality calfskin with two-way zip fastening, features two separate inner and outer compartments to keep smaller items safe. The double M logo is embossed on the front of the bag, while the back features MAYBACH lettering. Beige topstitching on the handles and twelve metal studs round off the design. Size approx. 52 × 48 × 18 cm
 Basic RRP £4,428.33 (excl. VAT) **Total RRP £5,314.00 (incl. VAT)**

Blanket



Business bag



Holdall



Colour choices – metallic paints

The highly durable nature of the Mercedes-Benz paint system makes it one of the best clear coats available in the automotive industry. Metallic paint finishes are all available at no additional cost.

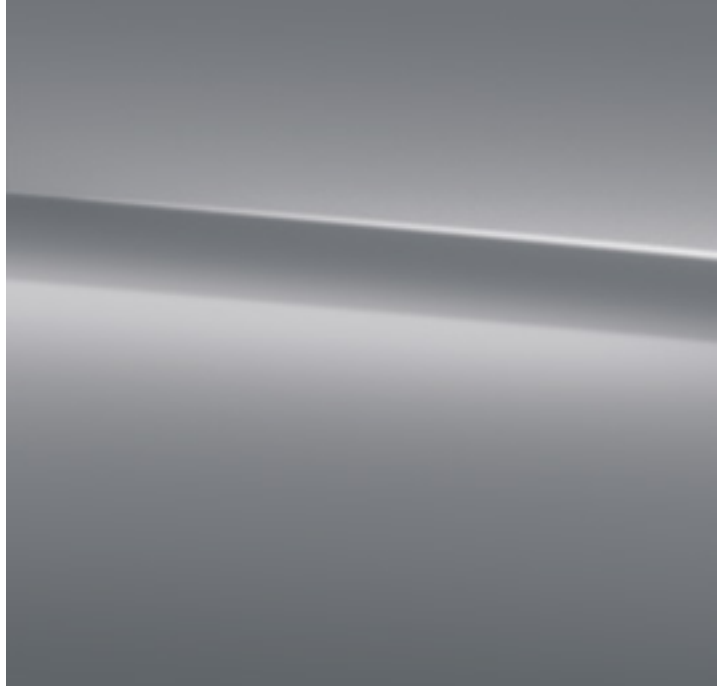

selenite grey (code 992)

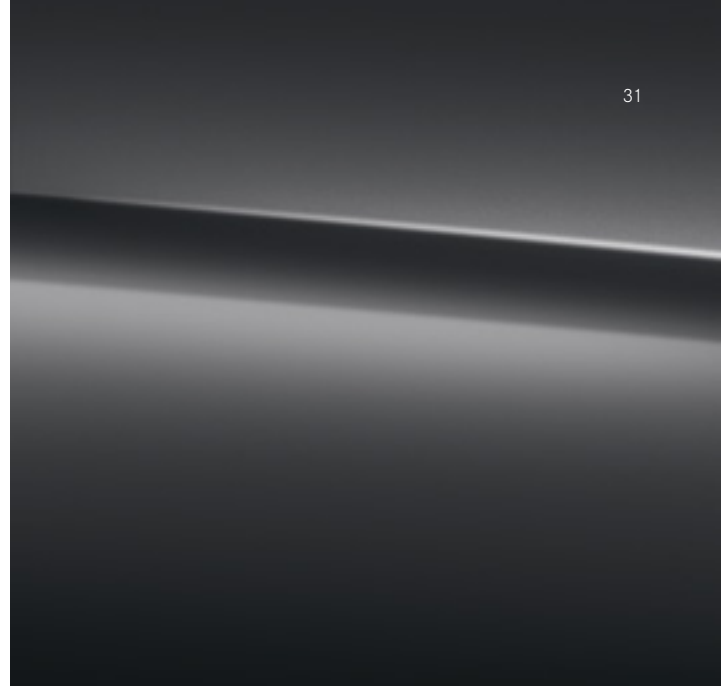

obsidian black (code 197U)

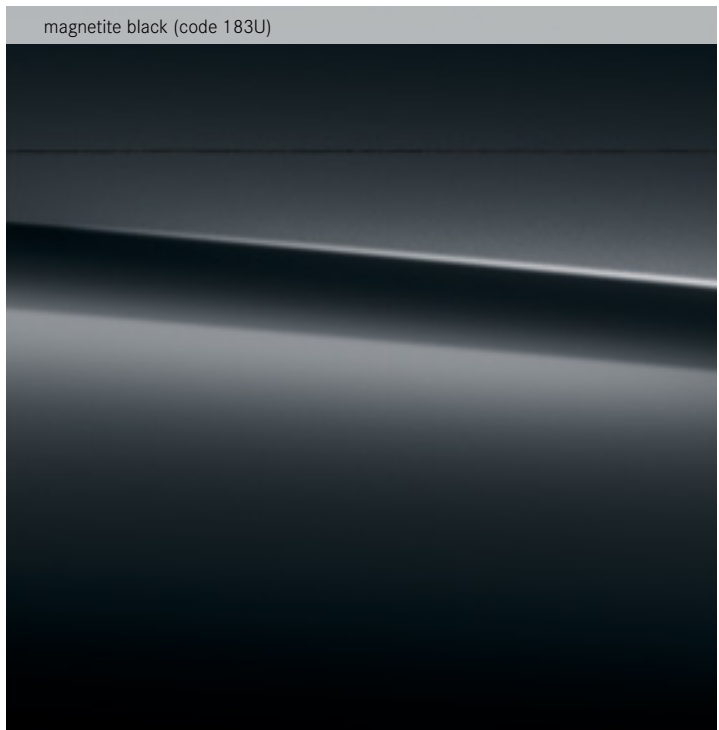

magnetite black (code 183U)

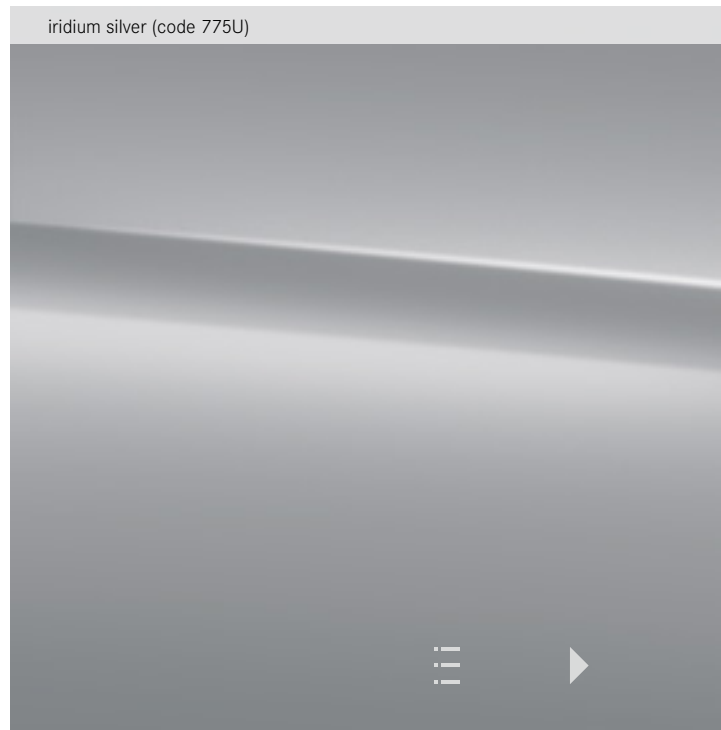

iridium silver (code 775U)

Please note that, owing to limitations of on-screen representation, paint colours may differ from those shown



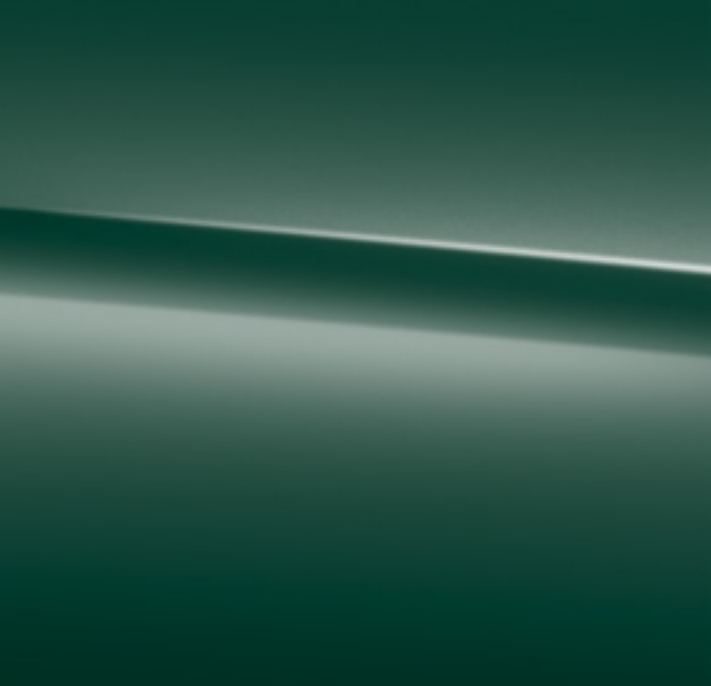

emerald green (code 989)

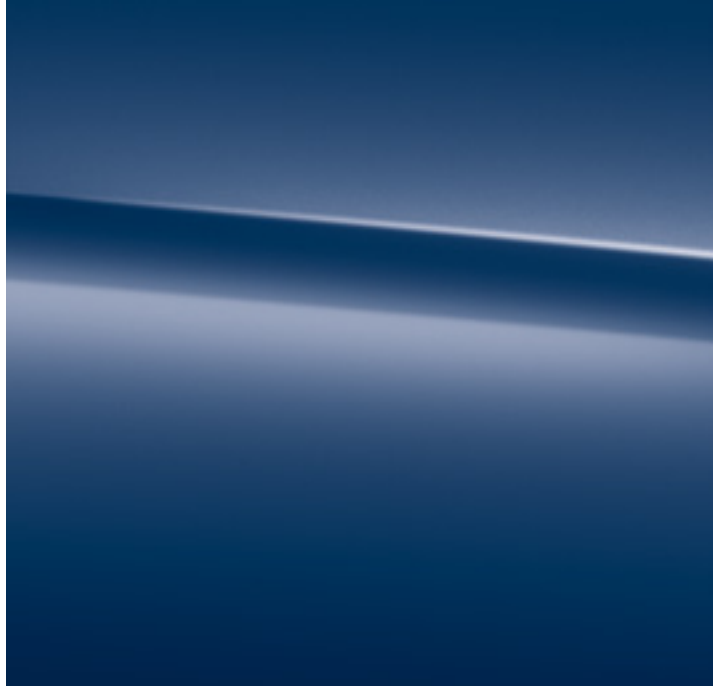

cavansite blue (code 890U)

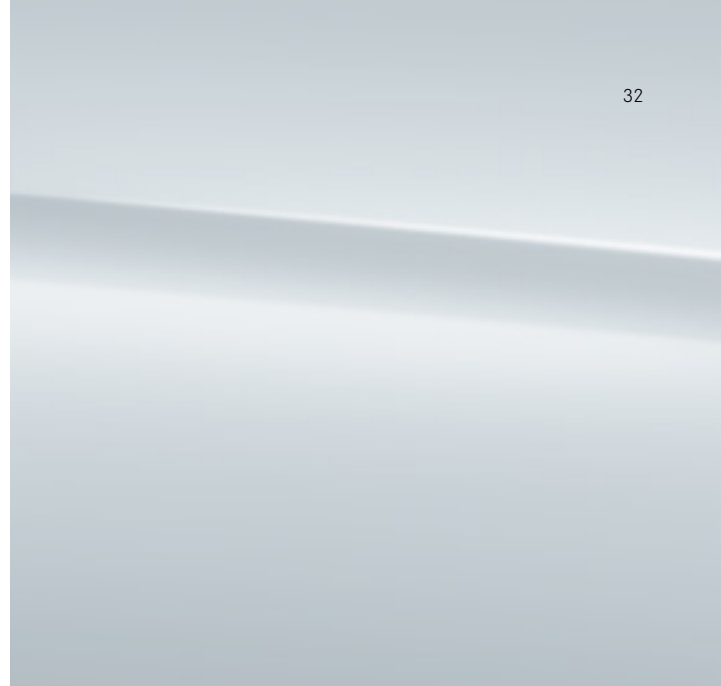

diamond silver (code 988U)



diamond white (code 799U)



ruby black (code 897U)

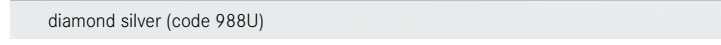

anthracite blue (code 998U)

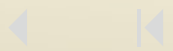
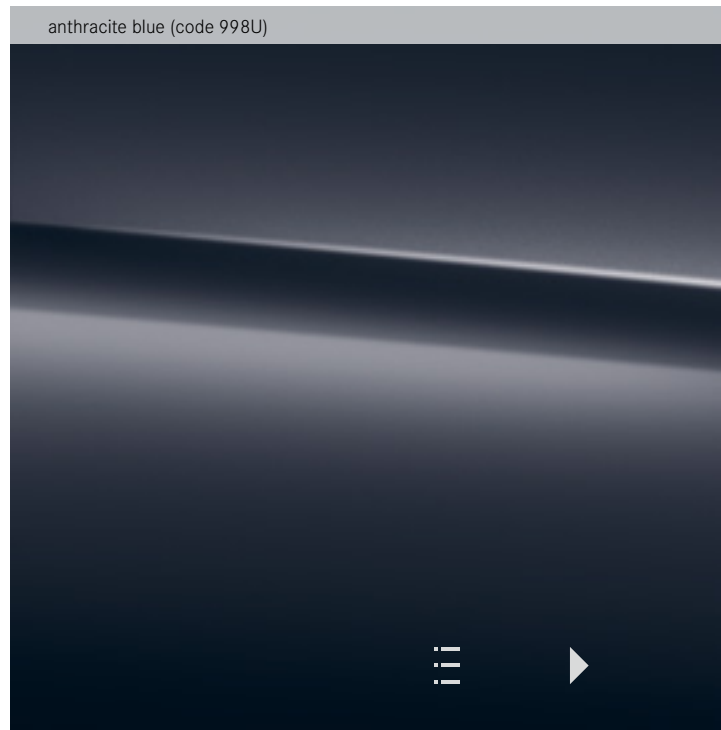
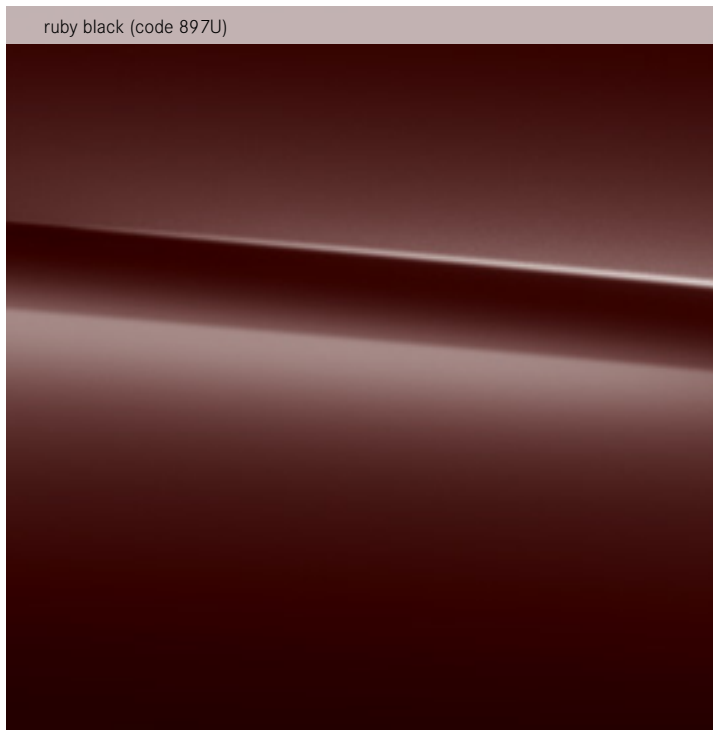
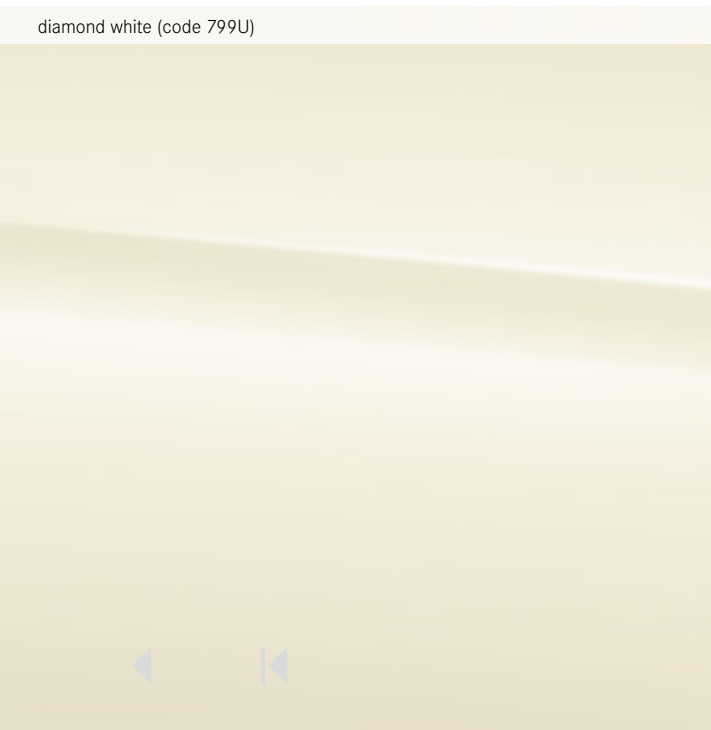

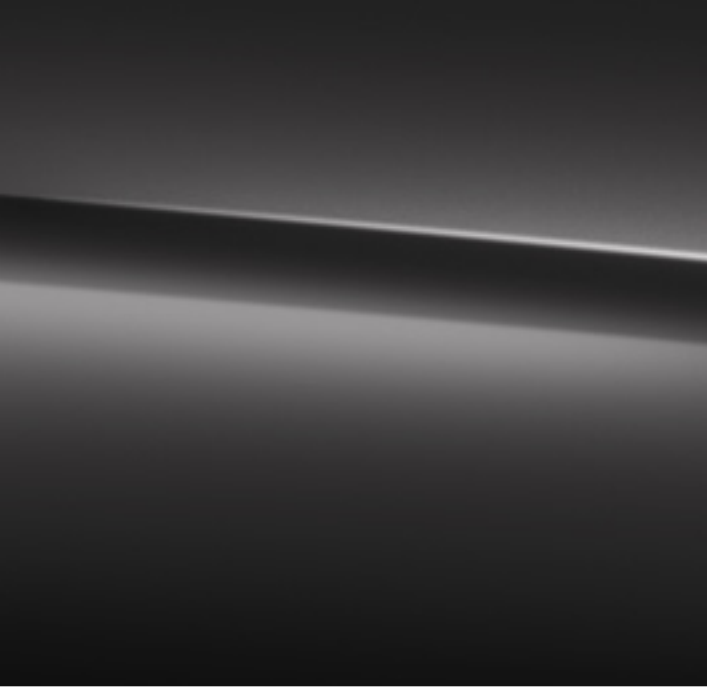

designo mocha black (code 033U)

Basic RRP £1,841.67 (excl. VAT) **Total RRP £2,210.00 (incl. VAT)**

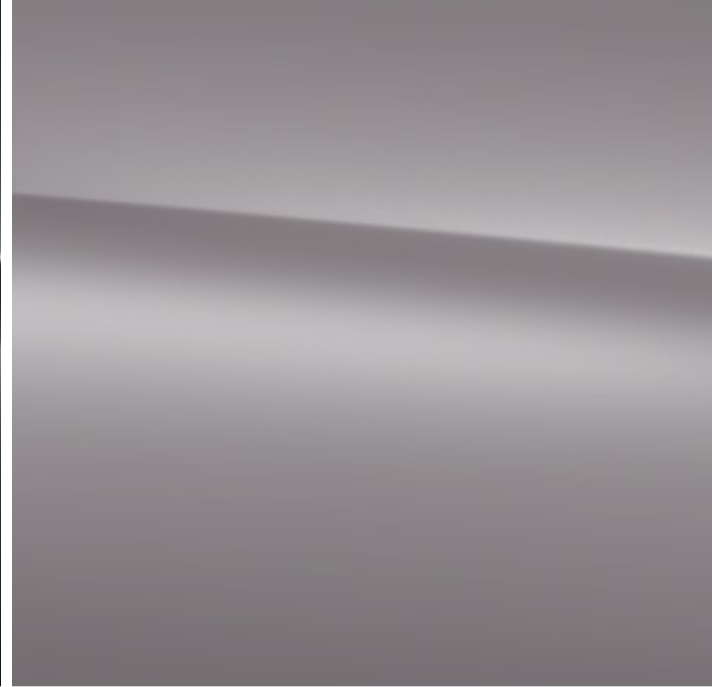

designo magno allanite grey¹ (code 044U)

Basic RRP £2,250.00 (excl. VAT) **Total RRP £2,700.00 (incl. VAT)**



designo magno cashmere white¹ (code 049U)

Basic RRP £2,250.00 (excl. VAT) **Total RRP £2,700.00 (incl. VAT)**

Colour choices – designo paints

An extra degree of exclusivity is guaranteed with designo's range of paint finishes, which are all available at additional cost.

¹designo magno matt paint finishes require extra care. Please refer to the Owner's Manual for instructions Please note that, owing to limitations of on-screen representation, paint colours may differ from those shown

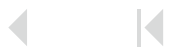

Trim and upholstery combinations

	Exclusive nappa leather					designo Exclusive semi-aniline leather	
	black (501)	silk beige/espresso brown (505)	crystal grey/seashell grey (508)	nut brown/black (514)	porcelain/black (515)	silk beige/satin red pearl (P87)	silk beige/titanium grey pearl (P62)
Dashboard							
Steering wheel	black	silk beige	crystal grey	black	black	silk beige	silk beige
Upper dashboard trim	black	espresso brown	seashell grey	black	black	satin red pearl	titanium grey pearl
Centre dashboard trim	black	silk beige	crystal grey	nut brown	porcelain	silk beige	silk beige
Lower dashboard trim	black	silk beige	crystal grey	black	black	silk beige	silk beige
Seats							
Seat cushion centre section	black	silk beige	crystal grey	nut brown	porcelain	silk beige	silk beige
Side bolster trim	black	silk beige	crystal grey	nut brown	porcelain	silk beige	silk beige
Head restraint	black	silk beige	crystal grey	nut brown	porcelain	silk beige	silk beige
Contrast stitching	black	silk beige/espresso brown	crystal grey/seashell grey	nut brown/black	porcelain/black	silk beige/satin red pearl	silk beige/titanium grey pearl
Seat belt	black	silk beige	crystal grey	nut brown	black	silk beige	silk beige
Doors							
Door trim at beltline	black	espresso brown	seashell grey	black	black	satin red pearl	titanium grey pearl
Door centre panel	black	silk beige	crystal grey	nut brown	porcelain	silk beige/satin red pearl	silk beige/titanium grey pearl
Lower door trim	black	silk beige	crystal grey	black	black	silk beige	silk beige
Roof lining	black	porcelain	crystal grey	black	black	porcelain	porcelain
Parcel shelf	black	espresso brown	seashell grey	black	black	satin red pearl	titanium grey pearl
Floor covering							
Front and rear	black	silk beige	crystal grey	black	black	silk beige	silk beige
Boot	black	black	black	black	black	black	black



Technical data

		Petrol
Model		S 600

Engine		
Capacity	cc	5,980
Arrangement/cylinders/valves		V/12/36
Power ¹	hp (kW) at rpm	530 (390)/4,900-5,300
Torque ¹	Nm at rpm	830/1,900-4,000

Transmission		
AMG SPEEDSHIFT MCT 7-speed sports transmission		●

Performance		
		auto.
Acceleration 0-62 mph	sec	5.0
Top speed	mph	155 ²

Weights and capacities		
		auto.
Kerb weight	kg	2,335
Perm. Gross Vehicle Weight	kg	2,815
Boot capacity	l	460

● Standard

¹Figures according to Directive 80/1269/EEC in the currently applicable version ²Electronically limited ³All figures are based on a standard specification with the smallest tyre size

⁴The choice of wheels and transmission may affect CO₂ emissions and corresponding Road Fund Licence ⁵EUDC: extra-urban driving cycle. Testing procedures adhere to EU Directive 93/116

The figures on pages 35-36 are correct at time of publication. Please refer to the government website for latest data - <http://www.dft.gov.uk/vca>

		Petrol
Model		S 600

Weights and capacities (continued)		
		auto.
Fuel tank capacity/of which reserve	l	80/8
Turning circle	m	12.9

Fuel consumption^{3,4}		
	mpg	auto.
Urban		16.7
Extra-urban ⁵		32.5
Combined		24.1

CO₂ emissions⁴		
	g/km	auto.
Emissions standard		EU6
20" alloy wheels - code 13R		274
20" alloy wheels - code 67R		274

Insurance		
Group rating		50A

Insurance ratings may vary depending on model line and specification.

Please refer to <http://www.thatcham.org/abigrouprating/> for further details



Dimensions

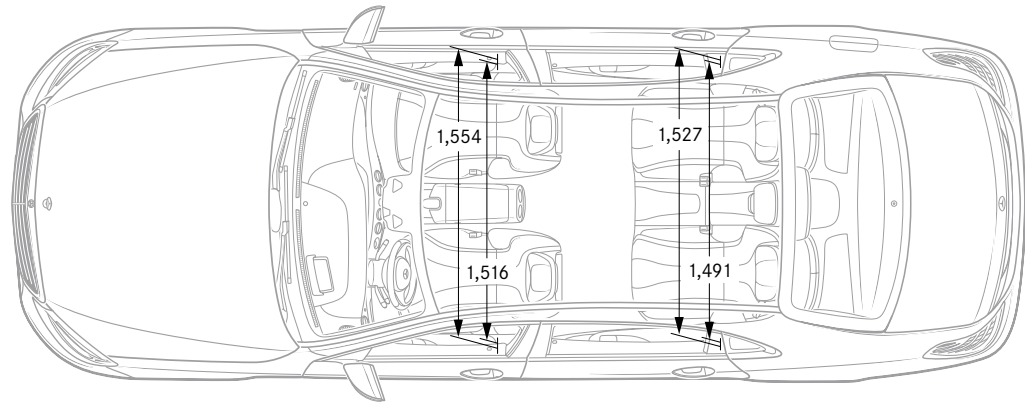
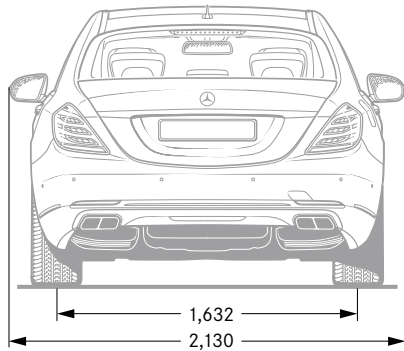
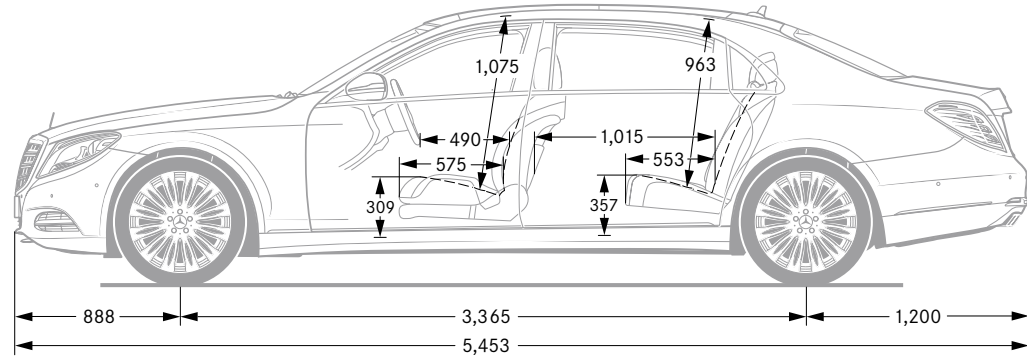
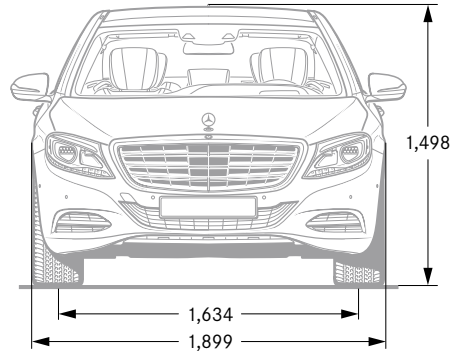

All measurements in millimetres. The dimensions shown are mean values and apply to standard-specification, unladen vehicles. Dimensions may vary slightly depending on the engine. Please consult your Retailer for further information



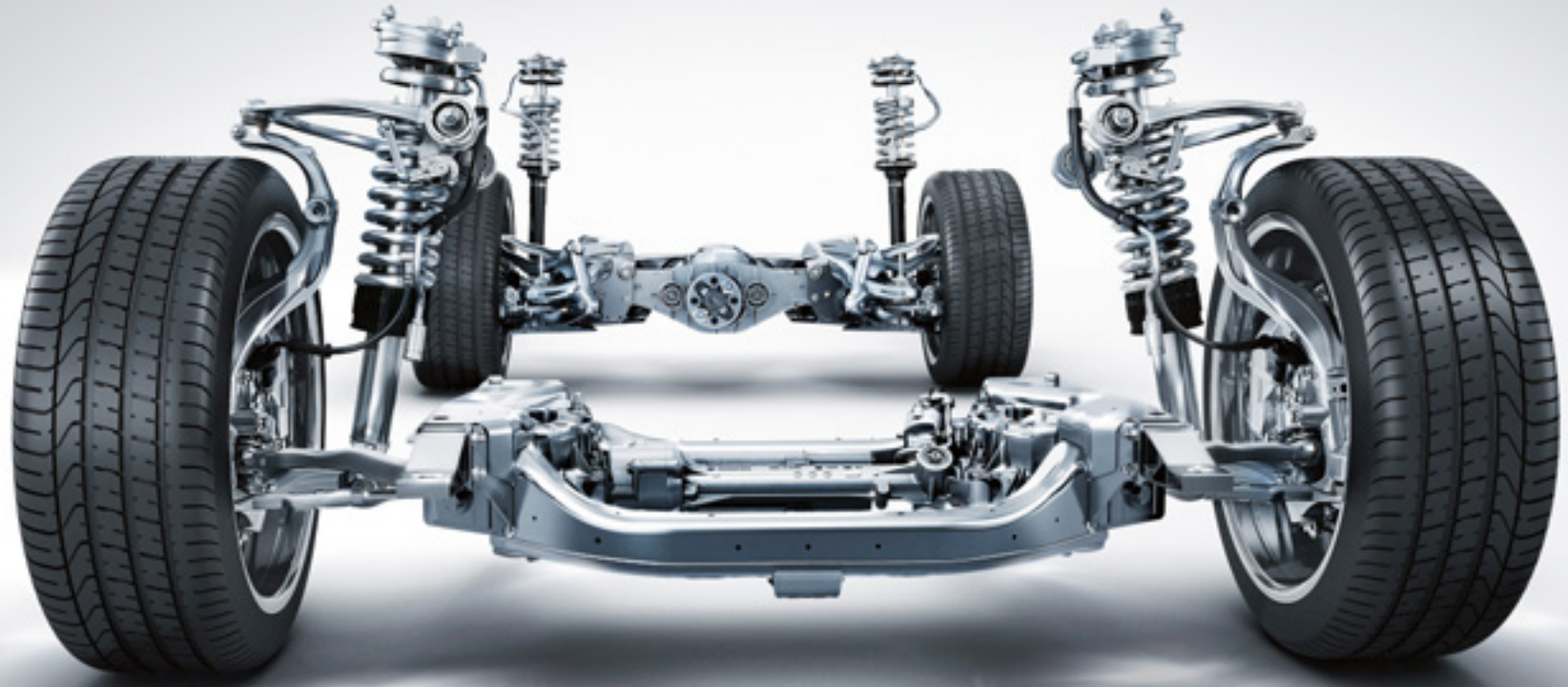

MAGIC BODY CONTROL detects bad road surfaces in advance and reacts accordingly. The active damping system of the suspension works with a road surface scan to achieve this

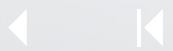

Services and benefits

Mercedes-Benz Service Care

We believe that servicing costs should be as flexible and affordable as possible for your Mercedes-Maybach S-Class, which is why we offer Service Care.

With Service Care we guarantee the price of parts and labour for up to three services and safeguard against further inflation. It also covers the cost of all recommended service items including brake fluid, spark plugs, air filters, fuel filters and screen wash.

You can choose either to add your servicing costs into your monthly spend or pay the full amount in a one-off payment, giving you peace of mind that they are taken care of for the period of the plan.

Warranty and breakdown cover

Every Mercedes-Benz comes with a three-year unlimited mileage warranty against manufacturing or material defects¹ and up to 30 years warranty against perforation due to corrosion from the inside out.² What's more, it's also covered by Mercedes-Benz Roadside Assistance – a unique package comprising up to 30 years pan-European breakdown assistance.²

Insurance

Since our name is synonymous with reliability, who better to trust with your motor insurance? Mercedes-Benz Insurance provides a motor insurance policy specifically designed to give you the cover you would expect from Mercedes-Benz. For a motor insurance quotation, call **0345 600 2180**.*

¹Applies to vehicles sold by Mercedes-Benz in the UK to its franchised Retailers ²Subject to full Terms and Conditions, dependent on date of registration, available upon request Mercedes-Benz Motor Insurance is underwritten by Aviva Insurance UK Limited. Credit provided, subject to status, by Mercedes-Benz Financial Services UK Ltd, MK15 8BA *For joint protection, calls may be recorded and/or monitored. All calls charged at local rate. We may decline to quote in some circumstances





Effective from 21 March 2017 Production. Information correct at time of publication.

Prices and specifications are subject to change without prior notice.

MBX222PL/0517

Mercedes-Benz Cars UK Limited, Tongwell, Milton Keynes, MK15 8BA. Company number 2448457 www.mercedes-benz.co.uk

