

Mercedes-Maybach S 600 Pullman

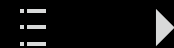

MAYBACH



A grand vision revealed.

The Mercedes-Maybach S 600 Pullman marks a magnificent new chapter in the most prestigious limousine's history. Ever since its launch in 1964, the Pullman has been celebrated the world over as a symbol of power, grandeur and luxury. Now the time has come to redefine the highest level of exclusivity and individuality, culminating in a spaciousness that reserves the ultimate comfort for those lucky enough to travel in this exceptional limousine.

Contents.

Mercedes-Maybach S 600 – exterior	3
Mercedes-Maybach S 600 – interior	14
Craftsmanship	29
Personalisation options	36
Wheels, colours, upholstery and trim options	46
Model and optional equipment pricing	59
Technical data and dimensions	62
Road Fund Licence	64

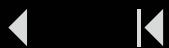

Mercedes-Maybach S 600 Pullman

A quest to fulfil wishes that have yet to be uttered. Erasing the boundaries between reality and illusion. It requires true vision to create a limousine that surpasses everything in terms of space, comfort and exclusivity. Now that vision has become reality. Based on the Mercedes-Maybach S 600, this limousine combines the most innovative technologies and the finest craftsmanship with unrivalled legroom.

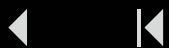

Expanding imagination.

With a total length of 6.499 metres, the Mercedes-Maybach S 600 Pullman creates an unparalleled realm of freedom. A limousine that commands the road without compromise.





A reflection of superiority.

The face of the Mercedes-Maybach S 600 Pullman shows true gravitas. It takes up a commanding position among the Mercedes-Maybach family. Sleek, assured and shaped to aerodynamic perfection, a history of elegance inspires the modern interpretation of cutting-edge technology in this ultimate limousine.



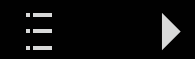
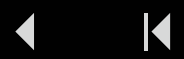

Beyond time and space.

An expression of authority. A force to be reckoned with.
A design that cuts through the air with effortless superiority.



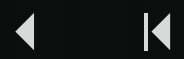



A question of leadership.

Setting new standards means leaving old perceptions behind. The Mercedes-Maybach S 600 Pullman continues a long tradition of innovation. It paves the way for one of the most luxurious limousines to grace the roads.

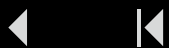



With only the sky above.

A discovery of limitless freedom. The large glass surfaces of the panoramic roof reveal endless vistas while protecting against the rays of the sun.

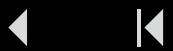

In the privacy of unlimited freedom.

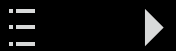
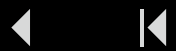
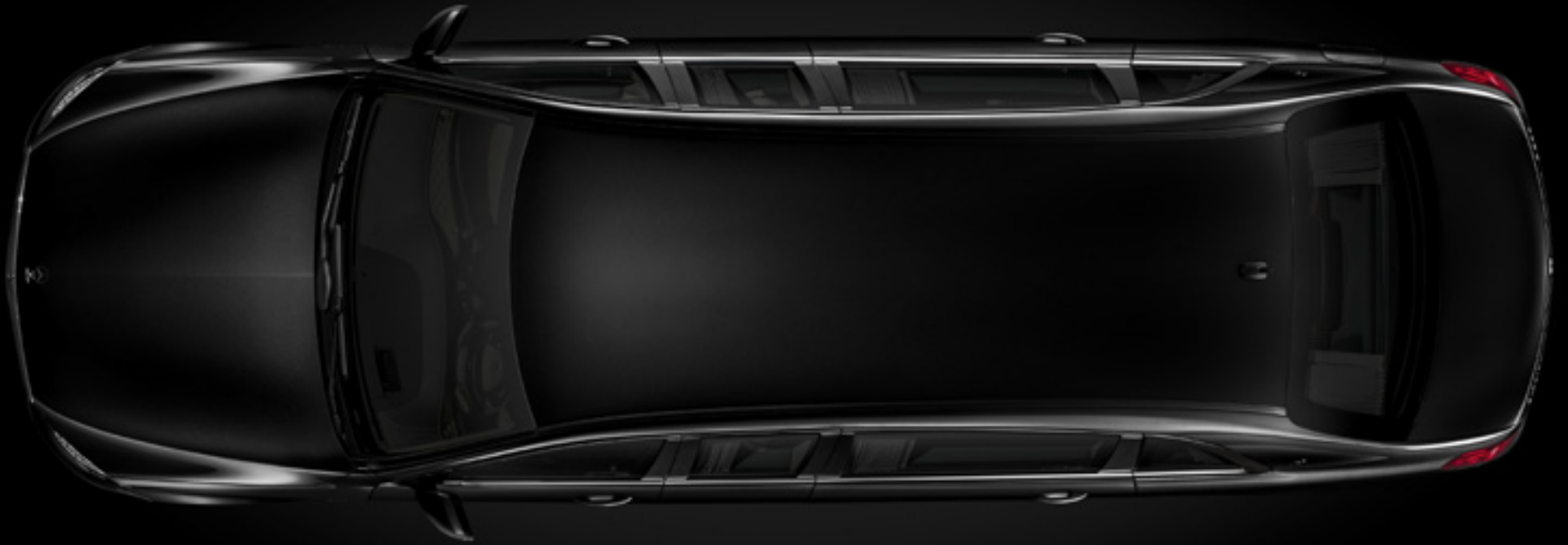

The hidden depths of ultimate luxury.

While the exterior of the Mercedes-Maybach S 600 Pullman hints at what lies beneath, the interior offers an even greater revelation: unrivalled spaciousness meets boundless comfort, with carefully chosen hand-finished materials crafted to perfection.

On entry, lambswool floor mats exude elegance and softness. The Executive seats with their special adjustment kinematics provide unparalleled comfort: the massage function, fragranced air conditioning, Warmth Comfort package, luxury head restraints, additional bolsters and vast legroom even in the fully reclined position set new standards. Innovative belt buckle extenders combine maximum convenience with outstanding safety.

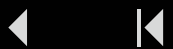





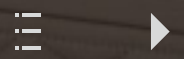
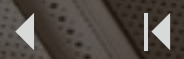

Discretely magnificent.

Passengers enjoy all the privacy they desire. The partition wall features a window with electrochromic glass. It can be electronically lowered and turned transparent or opaque at the touch of a button. An intercom system allows communication with the driver. To avoid prying eyes, the elegant curtains on the rear windows can be closed all round in just a few seconds.

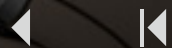

The shaping of a gem.

The Mercedes-Maybach S 600 Pullman with its all-leather interior makes no secret of its affinity for luxurious style. Enduring passion and dedicated craftsmanship dictate the finest hand-stitched leather coverings and carefully-selected wood veneers. The exclusive selection of wood trim combined with chrome elements and premium instruments creates an unrivalled ambiance of comfort and well-being.

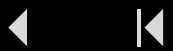







A sense of elevation.

The Mercedes-Maybach S 600 Pullman is a place to relax entirely, accompanied by a silver flute – or indeed, up to four – of perfectly-chilled champagne and the most sophisticated in-car entertainment system. An integrated refrigeration compartment with adjustable temperature reveals handmade silver flutes in specially-designed holders.

The Burmester high-end 3D surround sound system with 24 high-performance speakers and 24 separate amplifier channels delivers a previously unattainable listening experience. The difference between live music and sound reproduction appears to vanish, with magnificent results.

A conference-style seating arrangement is easily achieved: two comfortable rear-facing seats can be electrically folded down when additional seating is required. When folded up again, these seats reveal a built-in display screen.

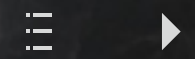
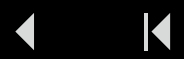







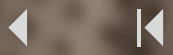
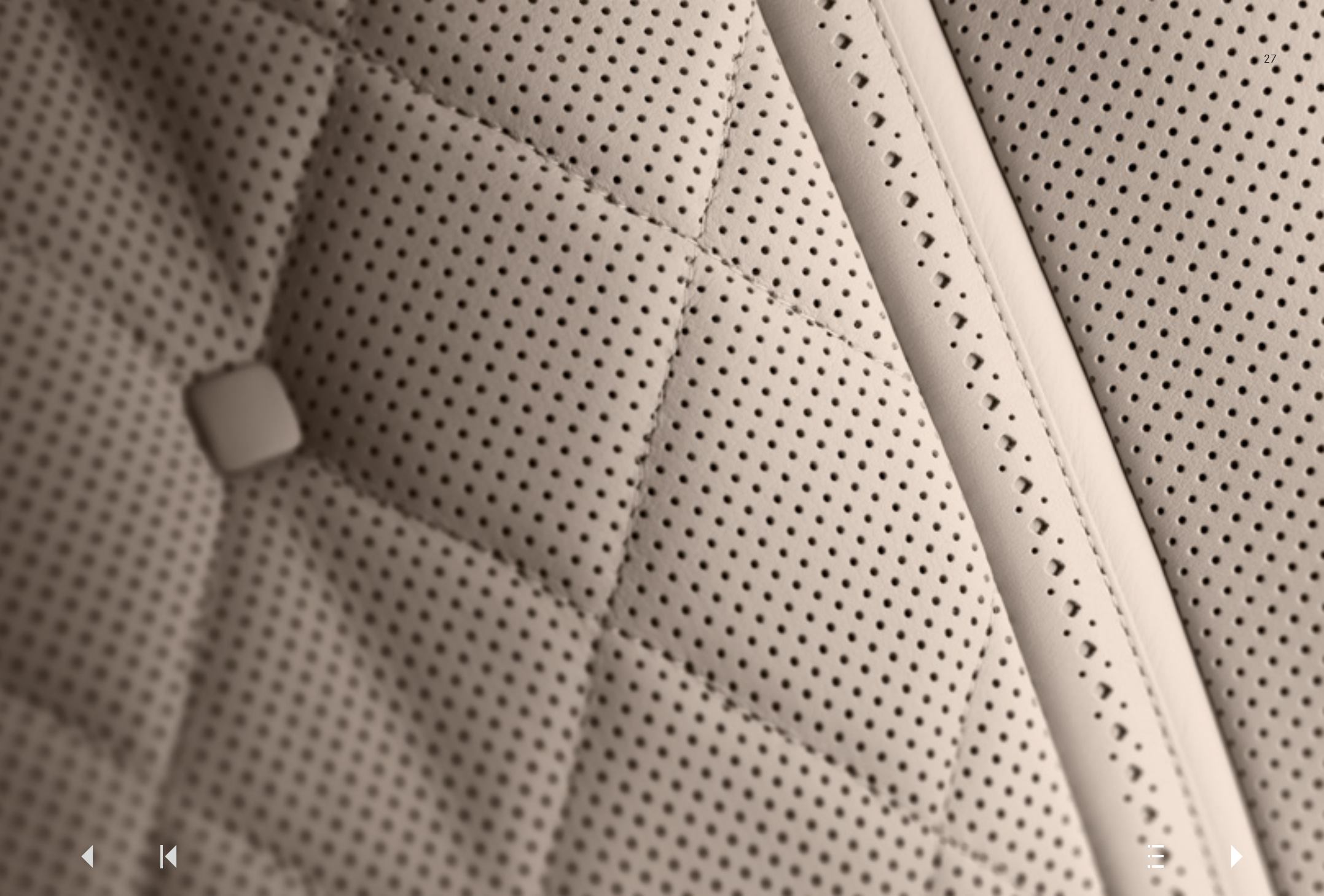

Beauty is in the detail.



Only the best leather hides are chosen to create the unique ambiance of well-being. Here, comfort is aimed at all the senses. Every minute detail contributes to an atmosphere far removed from the outside world. Every inch of the exclusive leather upholstery, every stitch of the diamond quilting reveals a passion to deliver nothing but the best. Equally, the finest craftsmanship and precision is mirrored by three solid tubular instruments that show speed, exterior temperature and time. Their classic style reflects the Maybach personality.



Master craftsmen and great attention to detail.

For all its modernity and innovation, the Mercedes-Maybach S 600 Pullman is a masterpiece in the traditional sense. Hand crafted by master craftsmen who bring their unique know-how, experience and utmost dedication to every stage of the building process. Because every Pullman is a labour of love.

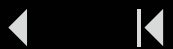

Feel-good atmosphere.



A myriad of details lies at the heart of the superior seating comfort in the Mercedes-Maybach S 600 Pullman. Each individual decorative seam is a testament to the highest levels of precision and breathtaking beauty. Expert hands ensure a perfect fit that's made to last. There's never been a more exclusive invitation to take a seat.

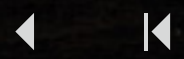

The art of metalworking.

In the hands of the most experienced craftsmen, pure metal is elevated to great beauty. Utmost attention to detail and perfectly-honed skills produce the finest metalwork in the Mercedes-Maybach S 600 Pullman. A work of art to stimulate all the senses.



Intrinsic beauty.

What lies beneath the natural beauty of the wood in the interior? Carefully chosen and cut veneer, hours of sanding, polishing and hand finishing. A deep understanding of how the grain reveals itself in the light. But there's much more to it: an unshakeable stability based on a metal carrier that adheres to the most rigorous safety standards in the cabin.





A passion for precision.

Only an obsession with detail leads to an aura of perfection. After all, this clock is designed to do much more than tell the time: it's an expression of the highest measure of form, style and discernment. All reflected in the dedicated craftsmanship of the clockmaker and the care with which this unique timepiece is installed.

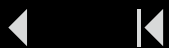



A question of nuance.

Colour is the canvas of incredible expressiveness in the Mercedes-Maybach S 600 Pullman. The high-quality paint finish is applied in several coats for a pristine surface and a brilliant finish. While there is a wide range of exclusive standard paint finishes, a truly individual exterior colour can also be chosen on request.

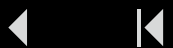





MINDEN

Signature style.



It requires many hours of one craftsman's steady hand to complete the beautiful steering wheel in the chosen leather. The vast opportunities to express personal style even extend to items that can be enjoyed outside your travels, like the optional exclusive Maybach handbag finished in the most exquisite leather to match the interior.





A crest of pride.



One cannot put a price on the value of family. Embracing origins and a sense of belonging, it bears strong emotions. Continuing traditions from the cradle, your name symbolises milestones of past, present and future.

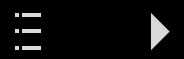





The sound of rapture.

The true meaning of harmony reveals itself in the universal language of music – with previously unheard-of precision and unprecedented listening pleasure. The speakers in the Burmester high-end 3D surround sound system are treated with an artificial ageing process before combining and matching selected frequencies. The system is then adapted to suit personal listening preferences and the preferred music style.





A lasting impression.

Manufactured with dedication and enjoyed in style, the flutes are designed according to personal wishes, then hand engraved with great skill. Quality and craftsmanship are taken to harmonious perfection in the Mercedes-Maybach S 600 Pullman.





The poetry of one's own name.

Your initials convey a unique message of belonging. A signature finish to a peerless vehicle.

LM

V12



Wheels, colours, upholstery and trim options.

A personal preference often derives from brief moments: an experience or a sentimental thought becomes a unique expression of individuality. Whether it's your favourite colour or the grain of the veneer, the Pullman captures choices that inspire and touch the heart.

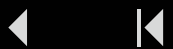

Wheels.

Choose between 20" iridium forged wheels; or, instead, opt for the 20" polished forged wheels in exclusive Pullman design with delicate spokes, which underline the flagship model's high-quality look.



20" iridium forged wheels (code E41)¹



20" polished forged wheels in exclusive Pullman design (code E42)²

¹Standard. ²Available at additional cost.

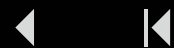

Shades of brilliance.

There were times when a Pullman dazzled solely in black. Today, stunning metallic paints, rich designo colours and Mercedes-Maybach premium hues reflect every facet of your personality.

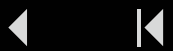

Metallic paints.*

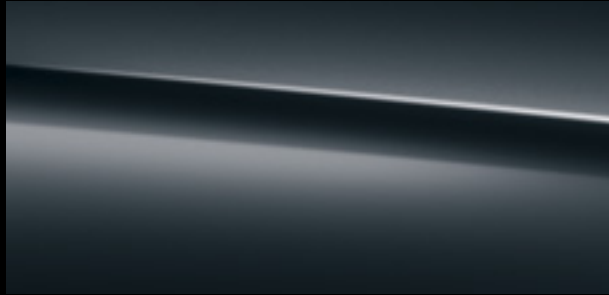

183 magnetite black

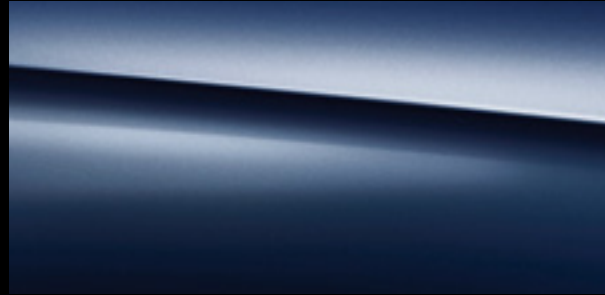

890 cavansite blue

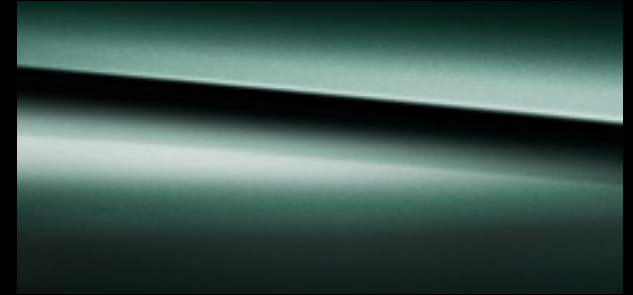

989 emerald green

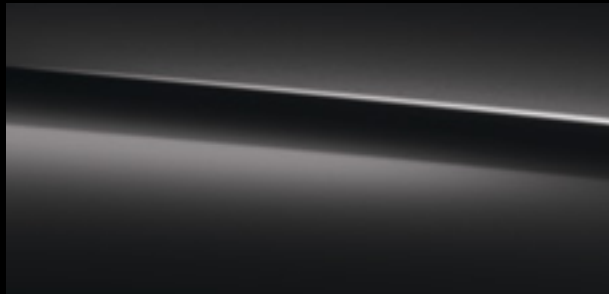

197 obsidian black

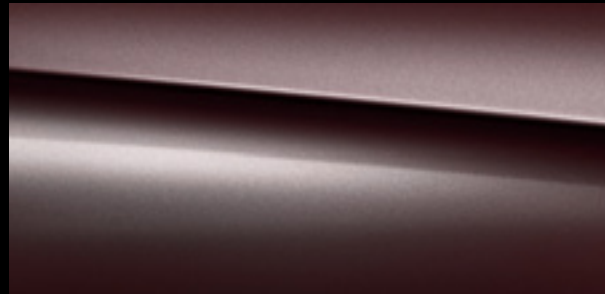

897 ruby black

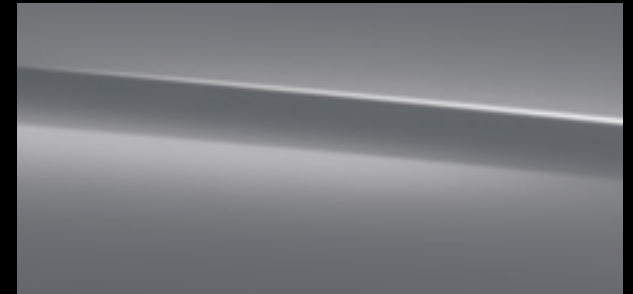

992 selenite grey

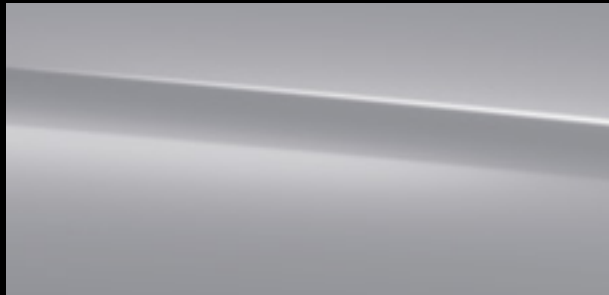

775 iridium silver



988 diamond silver



998 anthracite blue

*Available at no additional cost.

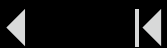

designo paints.*

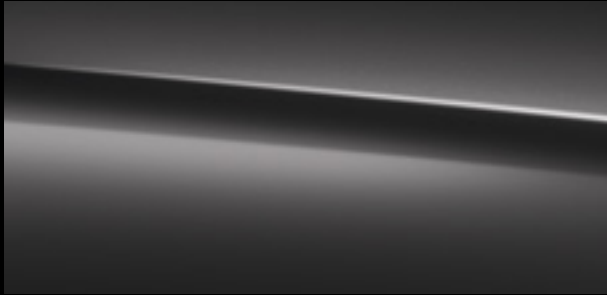

033 designo mocha black metallic



049 designo cashmere white magno

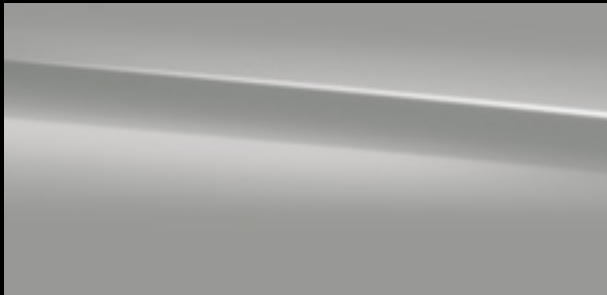

044 designo allanite grey magno



799 designo diamond white bright

*Available at no additional cost.

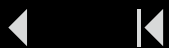

Mercedes-Maybach premium paints.*

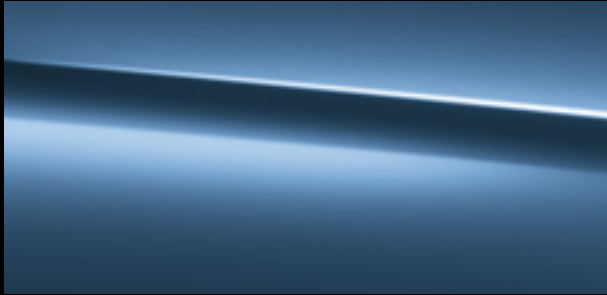

367 Côte d'Azur mid blue

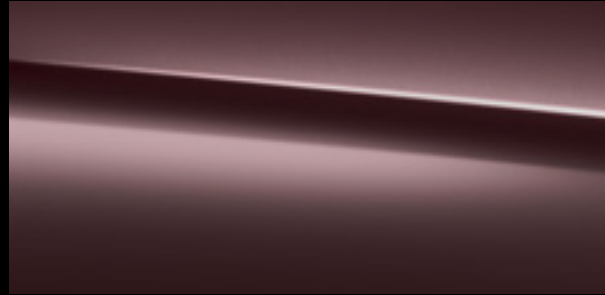

588 Ayers Rock red

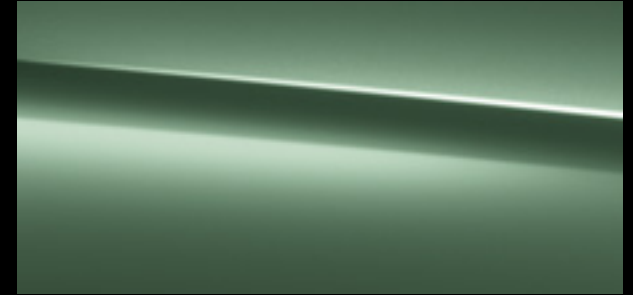

886 Ireland mid green

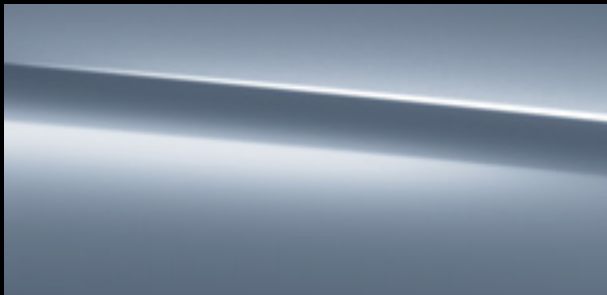

385 Côte d'Azur light blue



697 Rocky Mountains light brown

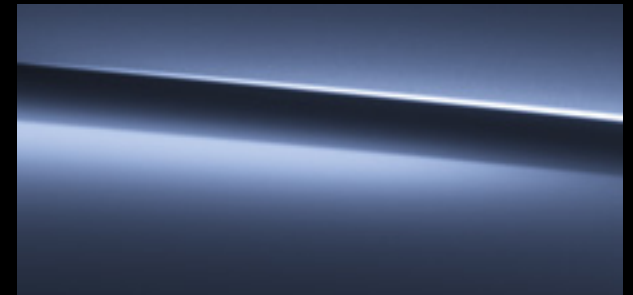

947 Côte d'Azur dark blue

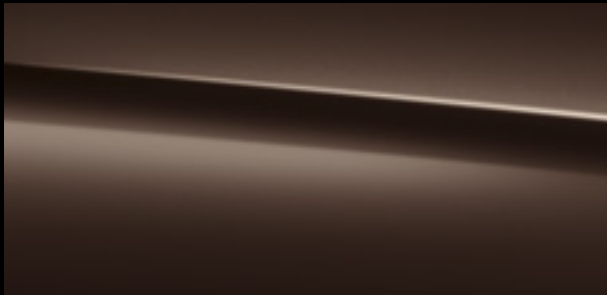

491 Rocky Mountains dark brown



773 Teide light grey

*Available at additional cost.

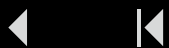



designo Exclusive semi-aniline leather.*



P62 silk beige/titanium grey pearl

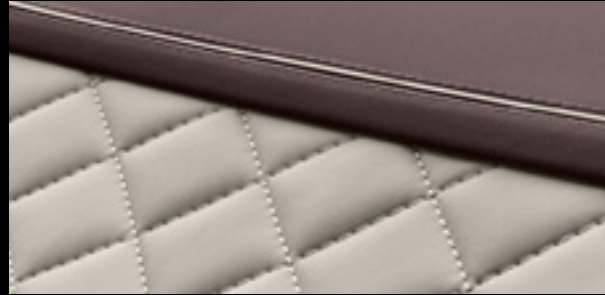

P87 silk beige/satin red pearl

*Available at no additional cost.

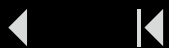



Exclusive nappa leather.*

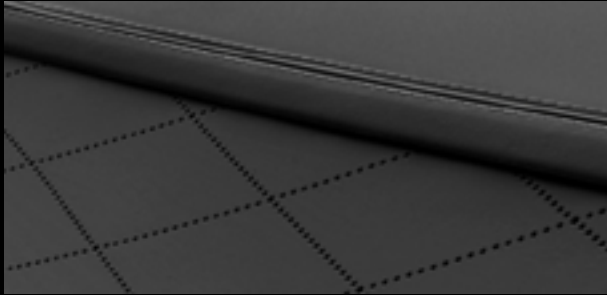

501 black/black

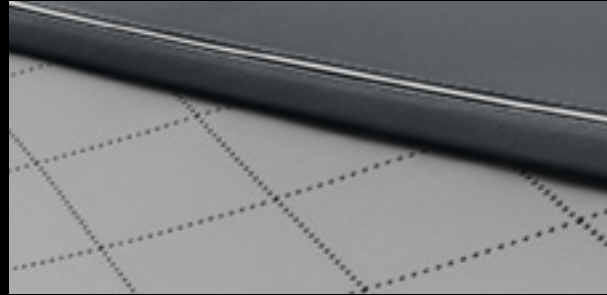

508 crystal grey/seashell grey

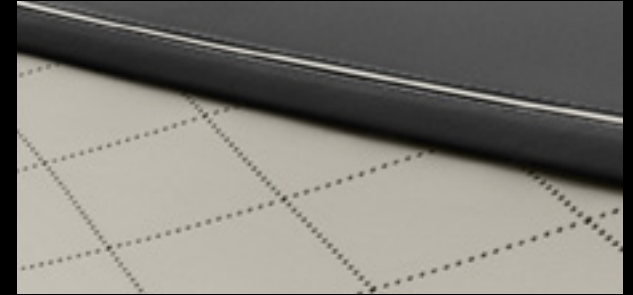

515 porcelain/black

*Available at no additional cost.

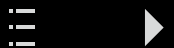
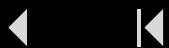

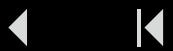

Wood trim.*



H21 designo black piano lacquer

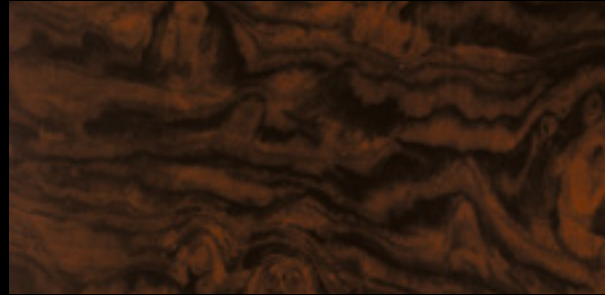

731 high-gloss brown burr walnut wood

*Available at no additional cost.

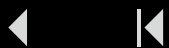

Realising your dream.

As iconic as the Pullman may be, it is your choice of equipment and styling that makes it truly your own. Here, you'll discover a wide range of optional comfort, design and aesthetic features with corresponding prices at a glance.

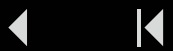

Model pricing.



Mercedes-Maybach S 600 Pullman Petrol – 5,980 cc, 12-cylinder, 530 hp/390 kW, Transmission 7G-TRONIC PLUS, CO ₂ 299 g/km	Basic RRP excl. VAT £435,237.50	Total RRP incl. VAT £522,285.00	Vehicle Excise Duty (RFL) Band M First year rate¹ £2,000.00	Premium rate £450.00	Rec. OTR price² £525,000.00	P11D value £522,945.00	BiK tax rate 2017/18 37%
--	---	---	--	--------------------------------	--	--------------------------------------	--

¹A different first year rate of Vehicle Excise Duty (Road Fund Licence) applies for new cars. Please refer to page 64 for details.

²The recommended on-the-road price includes the Road Fund Licence applicable to the standard model plus delivery charge (£635.00 incl. VAT), new vehicle registration fee (£55.00) and number plates (£25.00 incl. VAT). VAT is calculated at the standard rate of 20%.

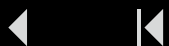

Optional equipment pricing.

Wheels

20" polished forged wheel in exclusive Pullman design (code E42)
 £8,333.00 (excl. VAT) **£10,000.00 (incl. VAT)**

Exterior Colours

Mercedes-Maybach premium paints
 £2,333.33 (excl. VAT) **£2,800.00 (incl. VAT)**

Mercedes-Maybach premium individual paint
 £4,458.33 (excl. VAT) **£5,350.00 (incl. VAT)**

Double sidelines on the exterior
 Make your Pullman even more exclusive by ordering the elegant double sidelines for the exterior
 £5,950.00 (excl. VAT) **£7,140.00 (incl. VAT)**

Comfort

Maybach semi-aniline leather pillow in the rear
 £1,275.00 (excl. VAT) **£1,530.00 (incl. VAT)**

Lambswool floor mats in the rear (2)
 £1,258.33 (excl. VAT) **£1,510.00 (incl. VAT)**

Relocation of subwoofer into the spare wheel cavity
 £5,491.67 (excl. VAT) **£6,590.00 (incl. VAT)**

Champagne for four: four silver flutes (incl. slotted anchoring)
 £5,825.00 (excl. VAT) **£6,990.00 (incl. VAT)**

Additional refrigerator between conference-style seats
 £14,325.00 (excl. VAT) **£17,190.00 (incl. VAT)**

Walk-through centre console in the rear
 £30,833.33 (excl. VAT) **£37,000.00 (incl. VAT)**

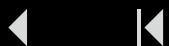

Aesthetics and Design

A touch of light: Maybach torches at C and D pillars – white light
 £4,000.00 (excl. VAT) **£4,800.00 (incl. VAT)**

A touch of light: Maybach torches at C and D pillars – ambient lighting
 £6,041.67 (excl. VAT) **£7,250.00 (incl. VAT)**

Diamond-quilted covering of the centre consoles (for example in armagnac/black or light brown/black)
 £2,208.33 (excl. VAT) **£2,650.00 (incl. VAT)**

Bicolour curtains in the rear, combinations: black, silk beige, crystal grey, porcelain
 £12,458.33 (excl. VAT) **£14,950.00 (incl. VAT)**

Maybach wheel hub cover
 £83.33 (excl. VAT) **£100.00 (incl. VAT)**

Car cover with logo: any lettering is possible on the front screen (approx. 340mm × 260mm)
 £1,958.33 (excl. VAT) **£2,350.00 (incl. VAT)**

Stitching

Maybach pillow with stitching (width 7 cm)
 £1,500.00 (excl. VAT) **£1,800.00 (incl. VAT)**

Stitching on floor mat with preferred embroidery (width 8/10/12 cm)
 £829.17 (excl. VAT) **£995.00 (incl. VAT)**

Headrest with stitching on DINAMICA microfibre covering (width 8/10/12 cm)
 £829.17 (excl. VAT) **£995.00 (incl. VAT)**

Headrest with stitching on leather covering (width 8/10/12 cm)
 £908.33 (excl. VAT) **£1,090.00 (incl. VAT)**

Stitching on cover (centre console cover/storage cover; in driver cabin/rear; width 8/10/12 cm)
 £1,275.00 (excl. VAT) **£1,530.00 (incl. VAT)**

Embossing

Embossing on storage cover in the rear (between executive seats or conference-style seats; width 8/10/12 cm)
 £1,458.33 (excl. VAT) **£1,750.00 (incl. VAT)**

Embossing on centre console cover (in driver cabin/rear; width 8/10/12 cm)
 £1,625.00 (excl. VAT) **£1,950.00 (incl. VAT)**

Additional headrest with embossing on leather covering (width 8/10/12 cm)
 £1,875.00 (excl. VAT) **£2,250.00 (incl. VAT)**

Technical data and dimensions.

Mercedes-Maybach S 600 Pullman

Arrangement/number of cylinders	V 12
Total displacement in cc	5,980
Rated output ¹ in hp (kW) at rpm	530 (390)/4,900–5,300
Rated torque ¹ in Nm at rpm	830/1,900–4,000
Acceleration from 0 to 62 mph in s	6.5
Top speed, approx., in mph	130
Tyres	PAX 255-720 R490 121Q.
Fuel	Super Plus petrol
Fuel consumption ² in mpg urban/extra-urban/combined	15.7/30.7/21.9
Combined CO ₂ emissions ² in mph	299
Emission standard ³	Euro 6
Tank capacity in l	80
Boot capacity ⁴ in l	361
Kerb weight ⁵ in kg	3,060
Perm. Gross Vehicle Weight in kg	3,600
Wheelbase ⁶ in mm	4,414

¹Figures for rated output and rated torque in accordance with Directive 80/1269/EEC in the currently applicable version.

²The figures shown were obtained in accordance with the prescribed measuring processes (Directive [EC] 715/2007 in the currently applicable version). Note according to Directive 1999/94/EC in the currently applicable version: the figures are not based on an individual vehicle and do not constitute part of the product offer; they are provided solely for purposes of comparison between different vehicle models.

³Valid only within the European Union. Information may vary from country to country.

⁴Figures pursuant to Directive 70/156 EWG, version 2000/40/EC.

⁵The figures shown were obtained in accordance with Directive 92/21/EC, version 95/48/EC (kerb weight with fuel tank 90% full, driver, 68 kg, and luggage, 7 kg) for standard-specification vehicles. Optional extras and accessories will generally increase this figure and reduce the payload capacity accordingly.

⁶The dimensions shown are average values and apply to standard-specification, unladen vehicles.

Further technical data can be found at www.mercedes-benz.co.uk

Emissions figures are correct at time of publication. Please refer to the government website for latest data - <http://carfueldata.direct.gov.uk/>

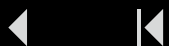

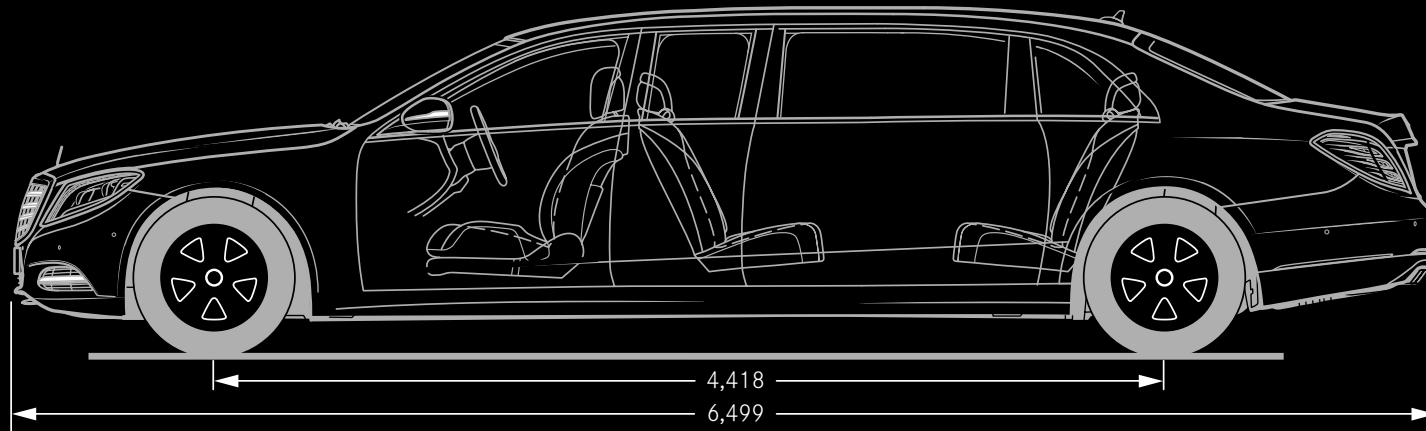
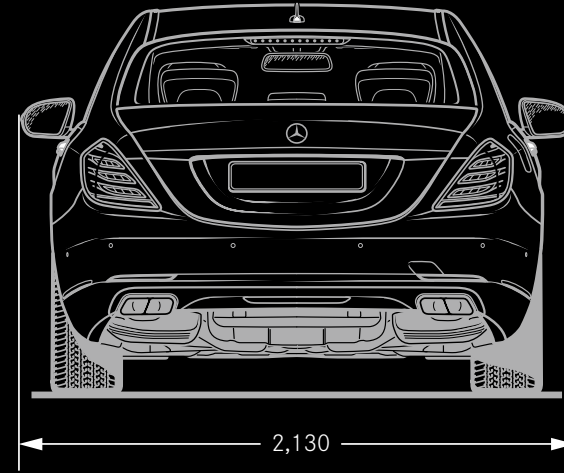
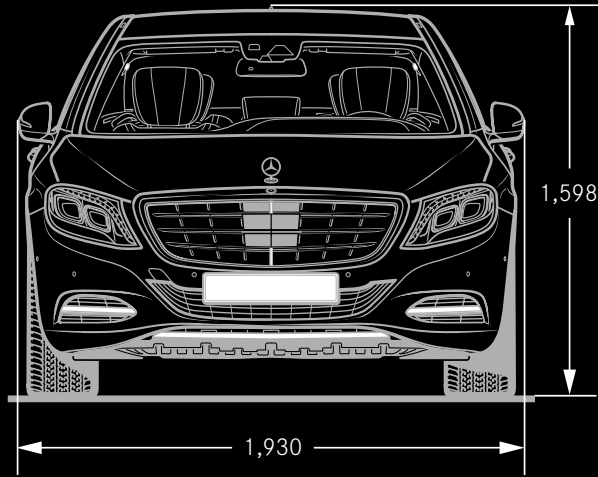

All measurements in millimetres. The dimensions shown are mean values and apply to standard-specification, unladen vehicles.

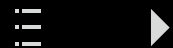
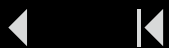

Road Fund Licence.

All road vehicle registrations are subject to Vehicle Excise Duty (Road Fund Licence), which varies in accordance with the vehicle's CO₂ emissions. A first year rate for each taxation band will apply. The table below shows the bands (A–M) created by the DVLA and the corresponding Road Fund Licence. CO₂ emission is quoted in the technical data on page 62, and the relevant Excise Duty is reflected in the on-the-road prices on page 59.

Band	CO ₂ emissions	First year rate (£)	Standard rate (£)	Premium rate (£) ¹
A	0 g/km	0.00	0.00	310.00
B	1 to 50 g/km	10.00	140.00	450.00
C	51 to 75 g/km	25.00	140.00	450.00
D	76 to 90 g/km	100.00	140.00	450.00
E	91 to 100 g/km	120.00	140.00	450.00
F	101 to 110 g/km	140.00	140.00	450.00
G	111 to 130 g/km	160.00	140.00	450.00
H	131 to 150 g/km	200.00	140.00	450.00
I	151 to 170 g/km	500.00	140.00	450.00
J	171 to 190 g/km	800.00	140.00	450.00
K	191 to 225 g/km	1,200.00	140.00	450.00
L	226 to 255 g/km	1,700.00	140.00	450.00
M	over 255 g/km	2,000.00	140.00	450.00

¹Premium rate only applicable to vehicles where the list price is over £40,000 including any factory-fitted options, standard UK delivery charge, number plates, fuel and VAT.

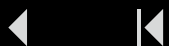

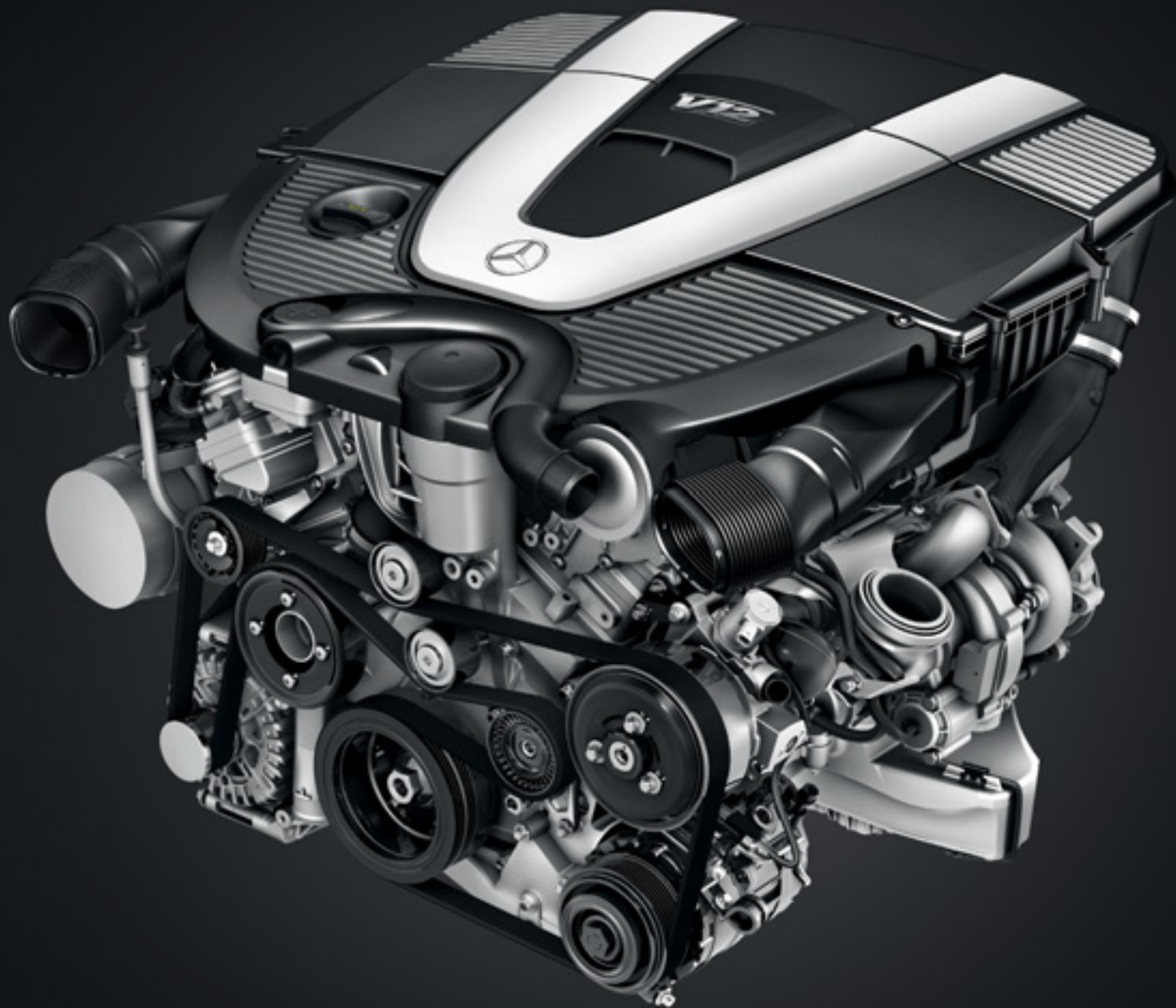

Everything your heart desires.

Always exceeding expectation, superlatives become the norm in the Mercedes-Maybach S 600 Pullman. The finest appointments and the highest level of finishing are ready to be challenged by your imagination. With your personal wishes, both the possibilities and the rewards are endless.





Effective from May 2017. Information correct at time of going to print.
Specifications are subject to change without prior notice.
MBX222PL/0517

Mercedes-Benz Cars UK Limited, Tongwell, Milton Keynes, MK15 8BA. Company number 2448457. www.mercedes-benz.co.uk

