



£ > View offers

 > Book a test drive

 > Find a Retailer

 > View the Range Guide

SL Roadster



Effective from 1 June 2017 Production.

Mercedes-Benz



Contents

Model prices	15	Wheels	37	Colours and materials	54
Finance offers	16	Active Body Control (ABC)	41	Technical data	58
AMG Line	20	Panoramic vario-roof	42	Road Fund Licence	62
designo Edition	22	Driving Assistance package	43	Services and insurance	63
Mercedes-AMG models	24	Night package	44	Mercedes me	64
Mercedes-AMG driver training	28	Optional equipment	46	Mercedes-Benz Finance	66
Standard equipment	30	Genuine Accessories	53		

The hard facts to melt your heart

At Mercedes-Benz we appreciate the importance of detail. Over the following pages you'll find model prices and a breakdown of standard and optional equipment, as well as details of the comprehensive services and benefits that are available to every Mercedes-Benz driver.

See Mercedes-Benz in a new light. Now is the time to get yourself behind the wheel of an SL. Choose from a number of attractive finance offers. Please see pages 16-19 for further details, or visit www.mercedes-benz.co.uk/offers

Of course, some things have to be experienced to be truly appreciated, such as the qualities that set a Mercedes-Benz apart. Which is why we'd like to invite you for a test drive at your local Mercedes-Benz Retailer. Alternatively, you can make arrangements by visiting www.mercedes-benz.co.uk/testdrive

For more information visit www.mercedes-benz.co.uk or call 0333 222 0500.



> View offers



> Book a test drive



> Find a Retailer



> View the Range Guide

4



Some of the model features, optional extras and colours shown may not be available, or may only be available in a different specification.



> View offers



> Book a test drive



> Find a Retailer



> View the Range Guide



Some of the model features, optional extras and colours shown may not be available, or may only be available in a different specification.



> View offers



> Book a test drive



> Find a Retailer



> View the Range Guide



6

Some of the model features, optional extras and colours shown may not be available, or may only be available in a different specification.



> View offers



> Book a test drive



> Find a Retailer



> View the Range Guide



Some of the model features, optional extras and colours shown may not be available, or may only be available in a different specification.



> View offers



> Book a test drive



> Find a Retailer



> View the Range Guide



Some of the model features, optional extras and colours shown may not be available, or may only be available in a different specification.



> View offers



> Book a test drive



> Find a Retailer



> View the Range Guide





> View offers



> Book a test drive



> Find a Retailer



> View the Range Guide



Some of the model features, optional extras and colours shown may not be available, or may only be available in a different specification.



> View offers



> Book a test drive



> Find a Retailer



> View the Range Guide



Some of the model features, optional extras and colours shown may not be available, or may only be available in a different specification.



> View offers



> Book a test drive



> Find a Retailer



> View the Range Guide



Some of the model features, optional extras and colours shown may not be available, or may only be available in a different specification.



> View offers



> Book a test drive



> Find a Retailer



> View the Range Guide



Some of the model features, optional extras and colours shown may not be available, or may only be available in a different specification.



> View offers



> Book a test drive



> Find a Retailer



> View the Range Guide



Some of the model features, optional extras and colours shown may not be available, or may only be available in a different specification.

Model prices

Engine	Model line	Transmission	CO ₂	Basic RRP excl. VAT (£)	Total RRP incl. VAT (£)	Road Fund Licence (£) ¹	Rec. OTR price (£) ²	P11D value (£)	BiK tax rate 2017/18 (%)
SL 400 Petrol – 2,996 cc, 6-cylinder, 367hp/270 kW	AMG Line	9G-TRONIC PLUS 9-speed automatic	175	61,950.00	74,340.00	800.00	75,855.00	75,000.00	34
	designo Edition	9G-TRONIC PLUS 9-speed automatic	179	71,533.34	85,840.00	800.00	87,355.00	86,500.00	34
SL 500 Petrol – 4,663 cc, 8-cylinder, 455hp/335 kW	AMG Line	9G-TRONIC PLUS 9-speed automatic	205	69,200.00	83,040.00	1,200.00	84,955.00	83,700.00	37
	designo Edition	9G-TRONIC PLUS 9-speed automatic	210	78,783.34	94,540.00	1,200.00	96,455.00	95,200.00	37

Mercedes-AMG

Mercedes-AMG SL 63 Petrol – 5,461 cc, 8-cylinder, 585hp/430 kW	-	AMG SPEEDSHIFT MCT 7-speed automatic	229	95,175.00	114,210.00	1,700.00	116,625.00	114,870.00	37
Mercedes-AMG SL 65 Petrol – 5,980 cc, 12-cylinder, 630hp/463 kW	-	AMG SPEEDSHIFT PLUS 7G-TRONIC 7-speed automatic	279	144,312.50	173,175.00	2,000.00	175,890.00	173,835.00	37

¹A different first year rate of Vehicle Excise Duty (Road Fund Licence) applies for new cars. Please refer to page 62 for the relevant rate for the second and subsequent years

²The recommended on-the-road price includes the Road Fund Licence applicable to the standard model plus delivery charge (£635.00 incl. VAT), new vehicle registration fee (£55.00) and number plates (£25.00 incl. VAT). VAT is calculated at the standard rate of 20%

Mercedes-Benz Finance

It comes with a specification list worth exploring

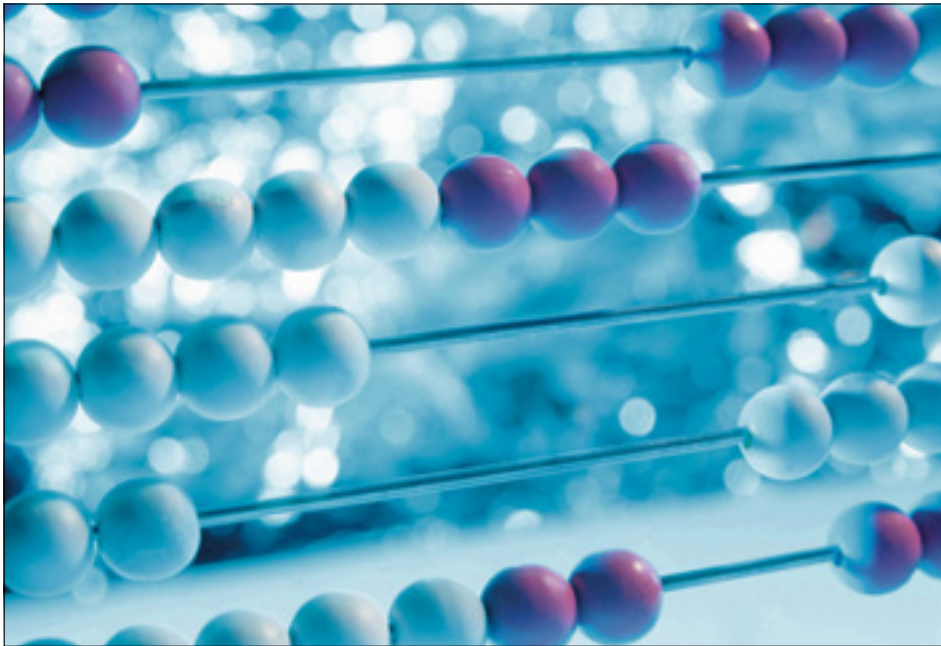

SL 400 AMG Line (representative example)

Based on 10,000 miles per annum

36 monthly payments of ¹	£759.00
Customer deposit	£9,999.00
On-the-road price	£75,855.00
Retailer deposit contribution	£10,907.00
Optional purchase payment ²	£27,625.00
Amount of credit	£54,949.00
Duration of agreement	36 months
Total amount payable ³	£75,855.00
Purchase activation fee ²	£0.00
APR	0.0%
Fixed interest rate	0.00%
Excess mileage	19.2p per mile

Example offer – 0% APR Representative	Automatic Metallic	On-the-road price	Retailer deposit contribution	Customer deposit	36 monthly payments of ¹
SL 400 AMG Line	● ●	£75,855.00	£10,907.00	£9,999.00	£759.00

● Standard equipment

Mercedes-Benz Service Care

- Mercedes-Benz trained Technicians
- Maintained by Mercedes-Benz Retailers
- Meets requirements of Mercedes-Benz Agility finance agreement

Mercedes-Benz Motor Insurance

- 24/7 UK accident recovery
- We use Mercedes-Benz GenuineParts
- To qualify for up to 10% discount online, go to www.mercedes-benz.co.uk/motorinsurance
- Alternatively, call Mercedes-Benz Motor Insurance now on **0345 600 2180⁴** for an annual quote

We may decline to quote in some circumstances. Mercedes-Benz Motor Insurance is underwritten by Aviva Insurance Limited

Content relating to finance is promoted by Mercedes-Benz Finance. Your Retailer may offer finance on behalf of other companies.

Orders/credit approvals on selected SL models only, between 1 July and 30 September 2017, registered by 31 December 2017; excluding Mercedes-AMG models. Some combinations of features/options may not be available. Please contact your local Mercedes-Benz Retailer for availability

¹Based on a Mercedes-Benz Agility agreement. Vehicle condition, excess mileage and other charges may be payable. Quotations available on request for alternative contract lengths and mileages. Guarantees may be required.

Credit provided, subject to status, by Mercedes-Benz Finance, MK15 8BA

²Payable if you exercise the option to purchase the car

³Includes optional purchase payment, purchase activation fee and Retailer deposit contribution (where applicable)

⁴Calls are charged at local rate and may be recorded

Mercedes-Benz Finance

It comes with a specification list worth exploring

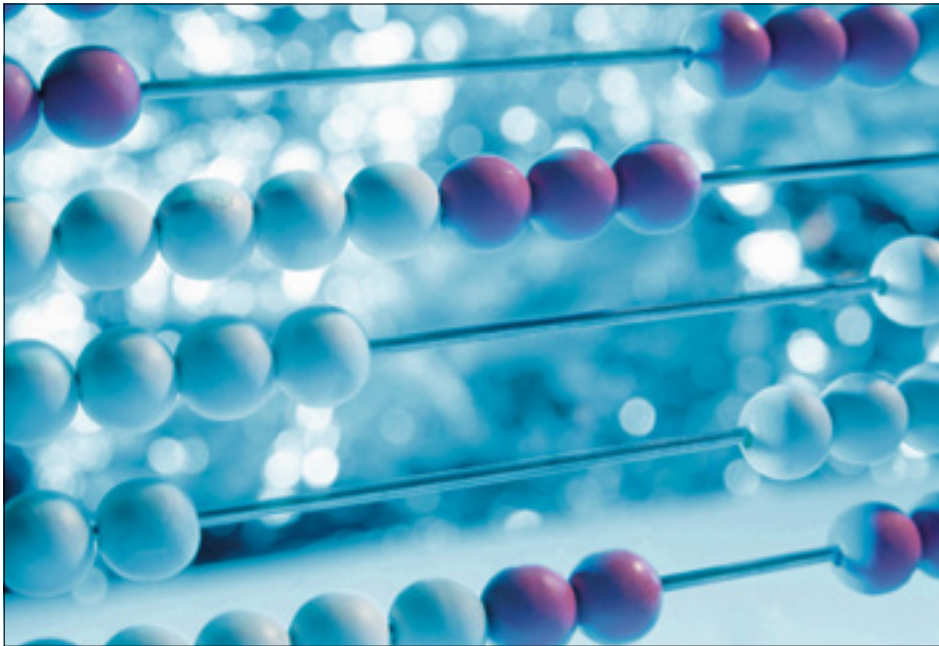

Mercedes-AMG SL 63 (representative example)

Based on 10,000 miles per annum

36 monthly payments of ¹	£1,405.83
Customer deposit	£14,999.00
On-the-road price	£116,625.00
Retailer deposit contribution	£16,500.00
Optional purchase payment ²	£45,275.00
Amount of credit	£85,126.00
Duration of agreement	36 months
Total amount payable ³	£127,393.88
Purchase activation fee ²	£10.00
APR	5.6%
Fixed interest rate	5.41%
Excess mileage	33.6p per mile

Example offer – 5.6% APR Representative	Automatic Metallic	On-the-road price	Retailer deposit contribution	Customer deposit	36 monthly payments of ¹
Mercedes-AMG SL 65	● ●	£175,890.00	£16,500.00	£14,999.00	£2,798.03

● Standard equipment

Mercedes-Benz Service Care

- Mercedes-Benz trained Technicians
- Maintained by Mercedes-Benz Retailers
- Meets requirements of Mercedes-Benz Agility finance agreement

Mercedes-Benz Motor Insurance

- 24/7 UK accident recovery
- We use Mercedes-Benz GenuineParts
- To qualify for up to 10% discount online, go to www.mercedes-benz.co.uk/motorinsurance
- Alternatively, call Mercedes-Benz Motor Insurance now on **0345 600 2180⁴** for an annual quote

We may decline to quote in some circumstances. Mercedes-Benz Motor Insurance is underwritten by Aviva Insurance Limited

Content relating to finance is promoted by Mercedes-Benz Finance. Your Retailer may offer finance on behalf of other companies.

Orders/credit approvals on selected Mercedes-AMG SL models only, between 1 July and 30 September 2017, registered by 31 December 2017; excluding non-Mercedes-AMG models. Some combinations of features/options may not be available. Please contact your local Mercedes-Benz Retailer for availability

¹Based on a Mercedes-Benz Agility agreement. Vehicle condition, excess mileage and other charges may be payable. Quotations available on request for alternative contract lengths and mileages. Guarantees may be required.

Credit provided, subject to status, by Mercedes-Benz Finance, MK15 8BA

²Payable if you exercise the option to purchase the car

³Includes optional purchase payment, purchase activation fee and Retailer deposit contribution (where applicable)

⁴Calls are charged at local rate and may be recorded

SL 400 and SL 500 AMG Line



Image top left shows 19" AMG alloy wheels (code 662), only available with Night package (code P60). SL 500 AMG Line wheels (code 785) are painted in titanium grey with high-shine finish

The new SL AMG Line presents its classic proportions more dynamically and expressively than ever before – courtesy of 19" AMG alloy wheels in titanium grey and AMG bodystyling, consisting of an AMG-specific front apron in A-wing design, rear apron with diffuser look and a diamond grille in chrome. The stiffened springs and damping of the lowered sports suspension

additionally enhance the car's driving dynamics. Inside, AMG sports seats feature black perforated leather with vertical fluting, and piping in designo platinum white pearl. Further eye-catching highlights of the AMG Line interior are the instrument cluster in a chequered-flag design and THERMOTRONIC automatic climate control.

Exterior

19" AMG alloy wheels (4) – 5-spoke design, painted in titanium grey with high-sheen finish (SL 400)

19" AMG alloy wheels (4) – 7-twin-spoke design, painted in titanium grey with high-sheen finish (SL 500)

Mirror package – projection of Mercedes-Benz logo integrated into both mirrors (from August 2016 production), electrically folding, automatically dimming exterior driver's mirror and rear view mirror

AMG bodystyling – see page 31

Active Parking Assist with PARKTRONIC

Headlamps – LED Intelligent Light System with Adaptive Highbeam Assist Plus

Braking system with perforated rear brake discs

Panoramic vario-roof with blind

Sports suspension, lowered, with stiffened suspension and damper settings

Interior

Memory package – front seats with four-way lumbar support, steering column and exterior door mirrors

AMG floor mats

AMG sports seats with perforated leather, vertical fluting and designo platinum white pearl piping

Chequered flag-design instrument cluster

THERMOTRONIC automatic climate control with two climate zones

Wind deflector (fabric)

Trim and Upholstery

Dark longitudinal-grain aluminium

Leather – black with vertical fluting

SL 400 and SL 500 designo Edition (code PEC)



Please note: some optional equipment may be shown

With its stylish design and attractive details, the SL designo Edition underscores the exclusivity of the vehicle. An impressive look is ensured thanks to 19"/20" AMG 10-spoke forged alloy wheels as well as chrome inserts in the front apron. The interior is characterised by exclusive design features

and high-quality materials, such as the designo nappa leather in porcelain/black and designo porcelain piano lacquer trim. A special level of comfort comes courtesy of the Active Multi-Contour Seat package, climatised seats and also AIRSCARF neck-level heating for driver and front passenger.

Exterior

Driving Assistance package

19"/20" AMG alloy wheels (4) - 10-spoke forged design, painted titanium grey

Active Parking Assist with PARKTRONIC

AMG bodystyling - see page 31

Brilliant blue metallic paint finish

Front splitter and A-wing cover in high-gloss chrome

'SL designo EDITION' front wing badging

Interior

Active Multi-Contour Seat package with massage function

3-spoke multifunction steering wheel, trimmed in two-tone black/porcelain nappa leather

AIRSCARF - neck-level heating

Ambient lighting

Black floor mats with porcelain lining

Comfort-ventilated seats

designo roof lining in porcelain DINAMICA microfibre

designo seat belts in white

Direct Select gear lever in porcelain leather

Wind deflector (fabric)

Trim and Upholstery

designo porcelain piano lacquer trim



designo nappa leather - porcelain/black





> View offers



> Book a test drive



> Find a Retailer



> View the Range Guide

Mercedes-AMG SL 63



Images show optional red-painted brake calipers (code U70)

The Mercedes-AMG SL 63 says performance even at a standstill. Its SL 63-specific bodystyling comprises a front apron with front splitter in chrome and A-wing trim strip in high-gloss black, while 10-spoke 19" alloy wheels, AMG sports exhaust system with two chromed twin tailpipes and the 'V8 BITURBO' lettering on the front wings further add to the dynamic look. Climb inside and the racing feel is unmistakable, thanks to the nappa

leather-trimmed AMG Performance steering wheel with flattened bottom section, silver-coloured aluminium gear shift paddles and the twin-tube-look AMG instrument cluster with TFT multifunction colour display. The AMG sports seats come in nappa leather upholstery with trim elements in AMG carbon fibre.

Exterior

19" AMG alloy wheels (4) – 10-spoke design, painted titanium grey with high-sheen finish

AMG bodystyling – Mercedes-AMG SL 63-specific front apron with front splitter in silver chrome and A-wing trim strip in high-gloss black

AMG mechanical rear-axle limited-slip differential

AMG SPEEDSHIFT MCT 7-speed sports transmission with four transmission modes and RACE START function

AMG sports exhaust system with two chromed twin tailpipes

AMG sports suspension based on Active Body Control (ABC) – active suspension system, adjustable in two stages

'V8 BITURBO' lettering on front wings

Interior

AMG Performance steering wheel in nappa leather with perforated grip area, flattened bottom section, silver-coloured aluminium gear shift paddles and black 12-o'clock marking

AMG door sill panels in brushed stainless steel, illuminated in white, with 'AMG' lettering

AMG instrument cluster – twin-tube look with TFT multifunction colour display including AMG main menu and AMG start-up screen display

AMG sports seats with AMG-specific seat upholstery and embossed AMG emblem in backrests

Seats – multi-contour, heated

Trim and Upholstery

AMG carbon fibre



Nappa leather – black



Nappa leather – ginger beige/espresso brown



Nappa leather – bengal red



Nappa leather – porcelain/black

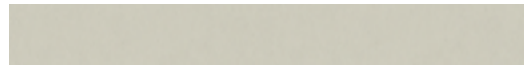



> View offers



> Book a test drive



> Find a Retailer



> View the Range Guide

Mercedes-AMG SL 65



Optional AMG high-performance ceramic composite braking system (code B07) shown

The Mercedes-AMG SL 65 provides a breathtaking driving experience with the unparalleled V12 engine on board. Eye-catching SL 65-specific AMG bodystyling with 19" or 20" AMG alloy wheels in a 10-spoke design and AMG carbon fibre engine cover emphasises the distinctive style. Inside there's an unmistakable air of luxury thanks to comfort-ventilated multi-contour AMG

sports seats with embossed 'AMG' emblem in the backrests and Exclusive nappa leather upholstery. High-sheen chrome AMG door sill panels with white backlighting guarantee a striking welcome, while the Bang & Olufsen BeoSound AMG surround sound system provides a suitably high-end acoustic backdrop.

Exterior

19"/20" AMG alloy wheels (4) – 10-spoke design, forged ceramic high-gloss polished

AMG bodystyling – Mercedes-AMG SL 65-specific front apron with front splitter and A-wing cover in high-gloss chrome

AMG carbon fibre engine cover – high quality genuine carbon fibre engine cover emphasises vehicle's sportiness

AMG SPEEDSHIFT PLUS 7G-TRONIC 7-speed automatic transmission

'V12 BITURBO' lettering on front wings

Interior

Driving Assistance package

AMG door sill panels in high-sheen chrome, illuminated in white, with 'AMG' lettering

AMG sports seats with AMG-specific 'V12' diamond pattern seat upholstery and embossed AMG emblem in backrests

Bang & Olufsen BeoSound AMG surround sound system

Seats – multi-contour, comfort ventilated

Trim and Upholstery

AMG carbon fibre



Exclusive nappa leather – black



Exclusive nappa leather – ginger beige/espresso brown



Exclusive nappa leather – bengal red



Exclusive nappa leather – porcelain

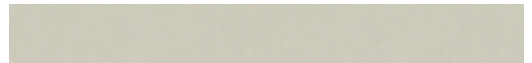

Exclusive driver training for Mercedes-AMG SL 63 and SL 65 owners

All Mercedes-AMG SL 63 and SL 65 customers are invited to a complimentary AMG Driving Academy Training experience at Mercedes-Benz World.



With friendly one-to-one tuition from a professional Mercedes-AMG driver, your training will be personalised to you. You'll push Mercedes-AMG driving performance and your driving skills to the limits on our track and purpose-built low friction dynamic handling facilities.

Through high-speed and adrenaline-fuelled exercises you'll experience oversteer, understeer, slaloms and many more performance driving skills. Designed as part of your ownership experience, this will lay the foundations to master a high-performance vehicle, develop driving skills with maximum enjoyment and prepare you to take full command of your own Mercedes-AMG.

TERMS AND CONDITIONS

The following only are eligible: the first purchaser/registered keeper of a newly-registered Mercedes-AMG SL 63 or SL 65; the second owner/registered keeper of a Mercedes-AMG purchased from a Mercedes-Benz Retailer, where the vehicle is less than 90 days from registration. The AMG Driving Academy Training experience is the AMG-PERFORMANCE Training as detailed in the further information above and must be booked and taken within six months of delivery of your Mercedes-AMG SL 63 or SL 65; it cannot be exchanged and cannot be transferred for any other driving experience. The Training experience is available Monday to Friday only and is subject to availability. Mercedes-Benz UK Limited reserves the right to amend or withdraw this Training experience. Attendees must hold a full UK driving licence. Attendees will be required to sign the Mercedes-Benz World Driving Risk Acknowledgement prior to undertaking the Training experience. The Training experience is also subject to the Mercedes-Benz World Terms and Conditions, as applicable.



> View offers



> Book a test drive



> Find a Retailer



> View the Range Guide



Standard equipment



Mirror package – including projection of Mercedes-Benz logo



Eight speakers with Frontbass



DYNAMIC SELECT with a choice of driving modes



LED Intelligent Light System with Adaptive Highbeam Assist Plus



Memory package



THERMOTRONIC automatic climate control



Item	AMG Line	designo Edition	Mercedes-AMG SL 63	Mercedes-AMG SL 65
Transmission and Suspension				
9G-TRONIC PLUS 9-speed automatic transmission with cruise control, variable speed limiter and steering wheel gearshift paddles	●	●	-	-
AMG mechanical rear-axle limited-slip differential Complimentary differential oil change required after first 1,800 miles	-	-	●	●
AMG SPEEDSHIFT MCT 7-speed sports transmission with four transmission modes and RACE START function	-	-	●	-
AMG SPEEDSHIFT PLUS 7G-TRONIC 7-speed automatic transmission with four transmission modes and RACE START function	-	-	-	●
DYNAMIC SELECT with a choice of driving modes: Comfort, Eco, Sport, Sport+ and Individual	●	●	-	-
AMG DYNAMIC SELECT with a choice of driving modes: Comfort, Sport, Sport+, Individual and Race	-	-	●	●
ECO start/stop function	●	●	●	●
Suspension – AMG sports suspension based on Active Body Control (ABC) active suspension system, adjustable in two stages	-	-	●	●
Suspension – with Adaptive Damping System	●	●	-	-
Suspension – sports suspension, lowered by 10 mm	●	●	-	-

Item	AMG Line	designo Edition	Mercedes-AMG SL 63	Mercedes-AMG SL 65
Exterior				
Mirror package – projection of Mercedes-Benz logo integrated into both mirrors (from August 2016 production), electrically folding, automatically dimming exterior driver's mirror and rear view mirror	●	●	●	●
KEYLESS-GO Comfort package The vehicle can be conveniently unlocked, started and locked with this access and drive authorisation system – simply by carrying the electronic key. The vario-roof can be opened and closed remotely by means of the vehicle key	○	○	○	●
Active Parking Assist with PARKTRONIC PARKTRONIC monitors the front and rear end while the driver is manoeuvring the vehicle and gives a warning if the risk of a collision is detected. Active Parking Assist makes it easier to find a parking space and also automatically steers the vehicle into parking spaces	●	●	●	●
AMG carbon fibre engine cover	-	-	○	●
AMG bodystyling Mercedes-AMG SL 63-specific front apron, with front splitter in silver chrome and A-wing trim strip in high-gloss black	-	-	●	-
AMG bodystyling Mercedes-AMG SL 65-specific front apron, with front splitter and A-wing cover in high-gloss chrome	-	-	-	●
AMG bodystyling Consisting of front apron in A-wing design, cooling air openings and front splitter in vehicle colour (in high-gloss chrome for designo Edition), diamond radiator grille in chrome, louvre in matt iridium silver and insert in high-gloss chrome, AMG-specific side sill panels, fins on front wings and bonnet in high-gloss chrome, AMG-specific rear apron with diffuser look in vehicle colour and side air outlets, insert in high-gloss black	●	●	-	-

Item	AMG Line	designo Edition	Mercedes-AMG SL 63	Mercedes-AMG SL 65
Exterior (continued)				
AMG boot lid spoiler	○	-	●	●
AMG radiator grille with twin louvre in silver chrome with 'AMG' lettering	-	-	●	-
AMG radiator grille with twin louvre in high-gloss chrome with 'AMG' lettering	-	-	-	●
AMG sports exhaust system with two chromed twin tailpipes	-	-	●	-
AMG sports exhaust system with two sets of twin chromed tailpipes in AMG 'V12' design	-	-	-	●
Closing aid for doors When initially engaged, the doors are automatically closed by servo motors, ensuring smooth and virtually silent closing	○	○	○	●
Fuel tank - 75-litre	○	○	●	●
Headlamps - LED Intelligent Light System with Adaptive Highbeam Assist Plus LED headlamps, highbeam and direction indicator LED position light, cornering light and daytime running lamps Dynamic headlamp range adjustment for ideal visibility in all weather, lighting and driving conditions Variable light distribution for driving on country roads and motorways as well as in heavy fog Active light function allows headlamps to pivot into bends by up to 15° to illuminate road surface more effectively, improving visibility Cornering light function: two LEDs per headlamp improve road illumination in tight bends by automatically switching on cornering light on the relevant side Enhanced fog lamp function illuminates outer half of the carriageway more effectively while reducing glare due to light reflected by fog. Can be activated at speeds below 44 mph and remains switched on up to 62 mph Welcome home function lights up LED fibre optics in the headlamps in blue after unlocking the vehicle, transitioning to white locator lighting	●	●	●	●

Item	AMG Line	designo Edition	Mercedes-AMG SL 63	Mercedes-AMG SL 65
MAGIC VISION CONTROL Allows the driver the best possible visibility even during the wiping process. Washer fluid is sprayed directly in front of the wiper blades and wiped away without delay. A heating system effectively lowers the risk of icing up	●	●	●	●
Panoramic vario-roof with blind - operable up to 25 mph	●	●	●	●
Tinted glass - green	●	●	●	●
'V8 BITURBO' lettering on front wings	-	-	●	-
'V12 BITURBO' lettering on front wings	-	-	-	●
Interior				
Memory package Front seats with four-way lumbar support, steering column and exterior door mirrors - electrically adjustable with memory	●	●	●	●
AIRSCARF - neck-level heating	○	●	○	●
Ambient lighting LED lighting located in the centre console, armrest and footwell. Offers a choice of three colours: solar red, polar blue and polar white. The lighting can be dimmed to suit personal tastes	○	●	●	●
AMG instrument cluster - twin-tube look with TFT multifunction colour display including AMG main menu and AMG start-up screen display including RACETIMER	-	-	●	-
AMG instrument cluster - twin-tube look with TFT multifunction colour display including AMG main menu and AMG 'V12 BITURBO' start-up screen display including RACETIMER	-	-	-	●

Item	AMG Line	designo Edition	Mercedes-AMG SL 63	Mercedes-AMG SL 65
Interior (continued)				
AMG-specific IWC-design analogue clock	-	-	●	●
AMG sports seats with AMG-specific seat upholstery and embossed AMG emblem in backrests	-	-	●	-
AMG sports seats with AMG-specific 'V12' diamond pattern seat upholstery and embossed AMG emblem in backrests	-	-	-	●
Automatic boot separator Electrically lowers the boot separator into position, meaning that manual closing is unnecessary. Returns to the upper position when luggage compartment flap is opened	●	●	●	●
Door centre panels – AMG 'V12' diamond pattern	-	-	-	●
Door sill panels – brushed stainless steel, illuminated in white, with 'AMG' lettering	-	-	●	-
Door sill panels – high-shine chrome, illuminated in white, with 'AMG' lettering	-	-	-	●
Door sill panels – with 'Mercedes-Benz' lettering	●	●	-	-
Floor mats – AMG floor mats	●	-	●	●
Floor mats – designo Edition in black with porcelain lining	-	●	-	-
Instrument cluster – outside temperature gauge	●	●	●	●
Instrument cluster – with chequered flag design	●	●	-	-
Seats – Active Multi-Contour Seat package with massage function	○	●	○	○
Seats – comfort-ventilated	○	●	○	●

Item	AMG Line	designo Edition	Mercedes-AMG SL 63	Mercedes-AMG SL 65
Seats – heated	●	-	●	-
Service indicator ASSYST	●	●	●	●
THERMOTRONIC automatic climate control with two climate zones	●	●	●	●
Wind deflector – fabric The fabric wind deflector provides draught protection in high winds and cooler weather conditions. It slots in between the roll-over bars and can be fitted or removed quickly and easily	●	●	●	●
Steering				
AMG speed-sensitive sports steering – provides power assistance according to the vehicle's speed	-	-	●	●
Direct-Steer system with speed-dependent servo assistance and variable steering ratio	●	●	-	-
Steering wheel – AMG Performance steering wheel in nappa leather with perforated grip area, flattened bottom section, silver-coloured aluminium gearshift paddles and black 12-o'clock marking	-	-	●	●
Steering wheel – 3-spoke multifunction sports steering wheel with flattened bottom section, 12 buttons and silver gear shift paddles, trimmed in nappa leather with perforated grip areas	●	-	-	-
Steering wheel – 3-spoke multifunction steering wheel, in two-tone nappa leather black/porcelain	-	●	-	-

Item	AMG Line	designo Edition	Mercedes-AMG SL 63	Mercedes-AMG SL 65
Paint, Trim and Upholstery				
Paint – metallic	●	●	●	●
Roof lining – black fabric	●	-	●	-
Roof lining – designo DINAMICA microfibre	-	●	○	-
Roof lining – designo leather	-	-	-	●
Trim – AMG carbon fibre	○	-	●	●
Trim – dark longitudinal-grain aluminium	●	-	○	○
Trim – designo porcelain piano lacquer trim	-	●	-	-
Upholstery – sun-reflecting leather and topstitching in contrasting colour with AMG Line-specific vertical fluting design	●	-	-	-
Upholstery – sun-reflecting nappa leather, perforated	○	-	●	-
Upholstery – sun-reflecting designo nappa leather, perforated	-	●	-	-
Upholstery – sun-reflecting Exclusive nappa leather, perforated	-	-	○	●

Item	AMG Line	designo Edition	Mercedes-AMG SL 63	Mercedes-AMG SL 65
Security and Safety				
Driving Assistance package Active Blind Spot Assist, Active Lane Keeping Assist and Distance Pilot DISTRONIC with PRE-SAFE® Brake	○	●	○	●
Active bonnet – pedestrian safety measure	●	●	●	●
ACTIVE BRAKE ASSIST Gives the driver a visual and audible warning if the set safety distance from a vehicle ahead or a stationary obstacle narrows; an autonomous braking function can give the driver a haptic warning by initiating braking	●	●	●	●
Airbags – dual-stage, driver and passenger	●	●	●	●
Airbags – head and sidebags, driver and passenger	●	●	●	●
Alarm system with immobiliser and interior protection (MBSS3)	●	●	●	●
ATTENTION ASSIST Continuously analyses driver behaviour and steering movements. If patterns are recognised which characterise drowsiness, the driver is prompted to take a break, and an audible warning is sounded. COMAND Online offers to search for a rest stop	●	●	●	●
Automatic front passenger airbag deactivation	●	●	●	●
Braking – adaptive brake lamps	●	●	●	●
Braking – ADAPTIVE BRAKE system with HOLD function	●	●	●	●
Braking – AMG high-performance braking system with 390×36 mm composite front brake discs and 360×26 mm rear brake discs	-	-	●	●
Braking – anti-lock braking system (ABS) with Brake Assist (BAS)	●	●	●	●



Item	AMG Line	designo Edition	Mercedes-AMG SL 63	Mercedes-AMG SL 65
Security and Safety (continued)				
Braking – brake calipers, painted grey with ‘Mercedes-Benz’ lettering	●	●	–	–
Braking – brake calipers, painted grey with ‘AMG’ lettering	–	–	●	●
Electronic Stability Programme (ESP®)	●	●	●	●
ESP® Curve Dynamic Assist Especially when accelerating on bends, the ESP®-based system ensures more stability and handling safety. When the ESP® sensors register a tendency to understeer on bends, this can be reduced by specific braking intervention at the inside wheels	●	●	●	●
First-aid kit and warning triangle	●	●	●	●
Headlamp Assist – automatic headlamp activation	●	●	●	●
Heated rear window with timer control	●	●	●	●
NECK-PRO active head restraints In a rear-end collision, the crash-responsive head restraints can be pushed forward by around 40mm and upwards by around 30mm. This enables the head to be supported at an earlier stage and the risk of whiplash injury to be reduced	●	●	●	●
Parking – Active Parking Assist with PARKTRONIC PARKTRONIC monitors the front and rear end while the driver is manoeuvring the vehicle and gives a warning if the risk of a collision is detected. Active Parking Assist makes it easier to find a parking space and also automatically steers the vehicle into parking spaces	●	●	●	●
Parking – electric parking brake	●	●	●	●

Item	AMG Line	designo Edition	Mercedes-AMG SL 63	Mercedes-AMG SL 65
PRE-SAFE® system with reversible seat belt tensioners for driver and passenger seats, closing function for side windows and automatic positioning of passenger seat	●	●	●	●
Rain-sensing windscreen wipers	●	●	●	●
Remote central locking	●	●	●	●
Roll-over bars with crash sensor, automatically raising	●	●	●	●
Seat belt pre-tensioners	●	●	●	●
Tyres – TIREFIT tyre-sealant kit	●	●	●	●
Tyres – tyre pressure monitoring system	●	●	●	●

Item	AMG Line	designo Edition	Mercedes-AMG SL 63	Mercedes-AMG SL 65
Communications and In-Car Entertainment				
Bluetooth® interface for hands-free telephony	●	●	●	●
Central controller dial to operate audio functions and telephone (when connected)	●	●	●	●
COMAND Online system ¹ Includes digital radio, single CD/DVD, 7-inch colour display, hard disk drive (HDD) navigation with 3D map display, Live Traffic Information and European map data updates free of charge for the first three years, Speed Limit Assist and LINGUATRONIC voice control. Internet-enabled mobile phone required for Mercedes-Benz emergency call system (eCall), Mercedes-Benz apps and in-car internet access for Facebook, internet radio, sending routes from Google Maps™ to the vehicle, news and weather reports. Also includes SD memory card slot and MP3 compatibility	●	●	●	●
Convenience telephony In the armrest with universal interface for various mobile phone cradles, extended telephone function, charging function and connection to LTE-compatible external aerial for optimum reception and data transfer	○	○	○	●
DAB digital radio tuner	●	●	●	●
Eight speakers with Frontbass	●	●	●	-

Item	AMG Line	designo Edition	Mercedes-AMG SL 63	Mercedes-AMG SL 65
Smartphone integration – comprising Apple CarPlay™ Compatible iPhones (iPhone 5 and newer) can be integrated into the vehicle via Apple CarPlay™. Please check on www.apple.com/uk/ios/carplay/ for compatibility and approved apps. Certain features and apps require a 3G or 4G data connection. Control of features available through voice control and controller on centre console	●	●	●	●
Surround sound system – Bang & Olufsen BeoSound AMG High-end sound system with 12 speakers and Frontbass, speaker covers in aluminium, two LED-illuminated tweeters featuring Acoustic Lens Technology, 900 watt output	○	○	○	●

A revolution in style

Item	Notes		SL 400 AMG Line	SL 500 AMG Line	designo Edition	Mercedes-AMG SL 63	Mercedes-AMG SL 65	Basic RRP excl. VAT (£)	Total RRP incl. VAT (£)
Wheels									
19" AMG alloy wheels (4) – 5-spoke design, painted titanium grey with high-sheen finish front: 255/35 tyres rear: 285/30 tyres			752	●	-	-	-	-	-
19" AMG alloy wheels (4) – 7-twin-spoke design, painted titanium grey with high-sheen finish front: 255/35 tyres rear: 285/30 tyres			785	-	●	-	-	-	-
19" AMG alloy wheels (4) – 7-twin-spoke design, painted high-gloss black with high-sheen finish front: 255/35 tyres rear: 285/30 tyres			662	△	△	-	-	-	Included in Night package



> View offers



> Book a test drive



> Find a Retailer





> View the Range Guide

Item	Notes		788	○	○	-	-	-	Basic RRP excl. VAT (£)	Total RRP incl. VAT (£)
Wheels (continued)			SL 400 AMG Line	SL 500 AMG Line	designo Edition	Mercedes-AMG SL 63	Mercedes-AMG SL 65			
19" AMG alloy wheels (4) – multi-spoke design front: 255/35 tyres rear: 285/30 tyres			788	○	○	-	-	-	745.83	895.00
19"AMG alloy wheels (4) – multi-spoke design, painted bi-colour high gloss black with high-sheen finish front: 255/35 tyres rear: 285/30 tyres	Only in conjunction with Night package (P60)		606	○	○	-	-	-	145.83	175.00
19"/20" AMG forged alloy wheels (4) – 10-spoke design, painted titanium grey front: 255/35 tyres rear: 285/30 tyres			766	-	-	●	-	-	-	-

● Standard ○ Optional - Not available



Item	Notes		SL 400 AMG Line	SL 500 AMG Line	designo Edition	Mercedes-AMG SL 63	Mercedes-AMG SL 65	Basic RRP excl. VAT (£)	Total RRP incl. VAT (£)	
Wheels (continued)										
19" AMG alloy wheels (4) – 10-spoke design, painted titanium grey with high-shine finish front: 255/35 tyres rear: 285/30 tyres	Optional red brake calipers (code U70) shown		799	-	-	-	●	-	-	-
19"/20" AMG alloy wheels (4) – 10-spoke design, forged ceramic high-gloss polished front: 255/35 tyres rear: 285/30 tyres	Optional AMG high-performance ceramic composite braking system (code B07) shown		659	-	-	-	●	-	-	-
19" AMG alloy wheels (4) – cross-spoke design, painted titanium grey with polished surface front: 255/35 tyres rear: 285/30 tyres	Optional red brake calipers code (U70) shown		657	-	-	-	○	-	1,329.17	1,595.00
				-	-	-	○		no-cost option	

● Standard ○ Optional - Not available



> View offers



> Book a test drive



> Find a Retailer



> View the Range Guide

Wheels

40

Item	Notes		SL 400 AMG Line	SL 500 AMG Line	designo Edition	Mercedes-AMG SL 63	Mercedes-AMG SL 65	Basic RRP excl. VAT (£)	Total RRP incl. VAT (£)
Wheels (continued)									
19"AMG alloy wheels (4) – cross-spoke design, painted matt black front: 255/35 tyres rear: 285/30 tyres	Optional red brake calipers (code U70) shown		658	-	-	-	△	△	Included in Night package

● Standard ○ Optional - Not available △ Available as part of an option package

Active Body Control (ABC)



ABC is arguably the highest-quality suspension system on the market, offering the ultimate in driving dynamics and comfort by automatically adapting the suspension setting to the prevailing driving situation.

The crosswind stabilisation function which is now additionally integrated in ABC is active from a speed of 50 mph and during straight-ahead driving and gentle cornering. Crosswind stabilisation is deactivated in response to pronounced and fast corrective steering by the driver.

Panoramic vario-roof



The SL combines the unique driving pleasure of a roadster with the everyday practicality and high acoustic comfort of a coupé. To open or close the

folding vario-roof in less than 20 seconds, just push a button. The process can be completed up to a speed of 25 mph.

Driving Assistance package

The Driving Assistance package contains a range of highly intelligent features to help you stay safe on the road – by making the drive more effortless, by warning of danger, and by taking steps to protect you in an emergency.

Driving Assistance package – designed and priced as a package, including items as listed.

AMG Line and Mercedes-AMG SL 63

Total incl. VAT £1,695.00

Standard on designo Edition and Mercedes-AMG SL 65

Driving Assistance package (code 23P)

Active Blind Spot Assist

Displays a red triangle in the exterior mirrors. When a road user is detected in the blind spot, the red triangle flashes and an audible warning sounds if the driver operates the indicators. Includes course-correcting braking intervention

Active Lane Keeping Assist

Detects signs of inadvertent drifting out of lane and warns the driver by vibrating the steering wheel and, if necessary, triggers one-sided braking intervention

BAS PLUS

Can lower the risk of rear-end collisions and support the driver during emergency braking by providing additional brake pressure

Distance Pilot DISTRONIC

Helps the driver to maintain a safe distance to the vehicle in front and so relieves the strain on the driver, especially on long journeys or in a traffic jam

PRE-SAFE® Brake

Warns the driver if it detects that a rear-end collision is imminent and, if there is no reaction, can take autonomous action to reduce the speed – even to the extent of full brake application



Night package for AMG Line



With striking design elements in black, the Night package underscores the sporty and expressive character of the new SL. The package comprises 19" AMG alloy wheels painted in high-gloss black, with exterior mirror housings, front splitter and rear apron diffuser insert also in high-gloss black.

Night package – designed and priced as a package, including items listed below.

SL 400 AMG Line	Total incl. VAT £995.00
SL 500 AMG Line	£595.00

Night package (code P60)

19" AMG alloy wheels (4) – 7-twin-spoke design, painted in high-gloss black with high-shine finish (code 662)

- Exterior mirror housings in high-gloss black
 - Front splitter in high-gloss black
 - Rear apron diffuser insert in high-gloss black
-





Night package for Mercedes-AMG SL 63 and SL 65



The Night package for the Mercedes-AMG models offers eye-catching exterior features to lend the vehicle an expressive style. The package is instantly recognisable by details such as the 19"/20" cross-spoke wheels in matt black, high-gloss black air outlets and fins, a rear apron with high-gloss black trim and two black chrome-plated tailpipes.

Night package – designed and priced as a package, including items listed below.

Mercedes-AMG SL 63

Total incl. VAT £2,575.00

Mercedes-AMG SL 65

£895.00

Night package (code P60)

19"/20" AMG alloy wheels (4) – cross-spoke design, painted matt black (code 658)

- AMG-specific rear apron with trim in high-gloss black
 - AMG sports exhaust system with two black chrome-plated tailpipe trim elements
 - Air outlet spanned by two fins on front wings in high-gloss black
 - A-wing trim strip in high-gloss black
 - Exterior mirror housings in high-gloss black
 - Fins on the bonnet in high-gloss black
 - Flics in high-gloss black
 - Front splitter in high-gloss black
 - Rear apron diffuser insert in high-gloss black
 - Side sill panel insert in high-gloss black
-



Optional equipment



Ambient lighting



Analogue clock



Bang & Olufsen BeoSound AMG surround sound system



KEYLESS-GO



Reversing camera



Panoramic roof with MAGIC SKY CONTROL

Item	Notes	AMG Line	designo Edition	Mercedes-AMG SL 63	Mercedes-AMG SL 65	Basic RRP excl. VAT (£)	Total RRP incl. VAT (£)	
AMG Performance Studio								
AMG Driver's package Includes an increase to your vehicle's electronically limited top speed (186 mph) and participation in one of the AMG BASIC-Training 'Power and Passion' events. The event is run by the AMG Driving Academy and held at a racetrack located in mainland Europe	For further information on this or any other AMG Driving Academy training, please speak to your Retailer, or visit www.mercedes-amg.com/driving-academy	250	-	-	○	○	2,354.17	2,825.00
AMG Exterior Carbon Fibre package Cross strut on front apron, exterior mirror housings, AMG carbon fibre boot lid spoiler		773	-	-	○	○	2,525.00	3,030.00
AMG carbon fibre engine cover High quality genuine carbon fibre engine cover emphasises vehicle's sportiness		B14	-	-	○	●	1,316.67	1,580.00
AMG high-performance ceramic composite braking system With composite brake discs, 420×39 mm front and 360×32 mm rear, plus specially-painted yellow brake calipers with 'AMG Carbon Ceramic' lettering	Not in conjunction with red-painted brake calipers. Please check with your Retailer for availability	B07	-	-	○	○	8,354.17	10,025.00
AMG Performance steering wheel in nappa leather/DINAMICA microfibre		L6K	-	-	○	○	350.00	420.00
AMG performance suspension – based on Active Body Control (ABC) Raises the critical limits of dynamic driving even further with significantly stiffer tuning compared with AMG sports suspension. The control parameters of the ABC suspension are also tuned to be even sportier		486	-	-	○	-	1,308.33	1,570.00
Brake calipers, painted red with 'AMG' lettering		U70	-	-	○	○	525.00	630.00

Item	Notes	AMG Line	designo Edition	Mercedes-AMG SL 63	Mercedes-AMG SL 65	Basic RRP excl. VAT (£)	Total RRP incl. VAT (£)
Suspension and Exterior							
Active Body Control (ABC) with curve tilting function The active suspension improves both comfort and driving dynamics. The chassis includes a curve tilting function - the vehicle leans inwards by up to 2.65°, similar to a motorbike. This reduces the perceived lateral forces and enhances ride comfort. The suspension level can be raised by 50 mm to increase ground clearance. At high speeds, the suspension is automatically lowered by up to 13 mm, helping to reduce aerodynamic drag and improve handling stability		487	○	-	-	2,566.67	3,080.00
Fuel tank - 75-litre capacity		U47 915	○	○	●	87.50	105.00
AMG boot lid spoiler		U47	○	-	●	50.00	60.00
Interior							
Analogue clock The round, high-quality analogue clock with the Mercedes star is easily visible on the dashboard		246	○	○	●	175.00	210.00
Steering wheel - 3-spoke multifunction sports steering wheel with flattened bottom section, 12 buttons and silver gearshift paddles, trimmed in wood/nappa leather	Only in conjunction with the following: satin-finish light brown poplar trim (code 729), but not in conjunction with crystal/grey upholstery (code 218); high-gloss brown burr walnut trim (code 731); high-gloss black ash wood trim (code 736)	L5D	○	-	○	529.17	635.00

Item	Notes		AMG Line	designo Edition	Mercedes-AMG SL 63	Mercedes-AMG SL 65	Basic RRP excl. VAT (£)	Total RRP incl. VAT (£)
Paint, Trim and Upholstery								
Paint – designo metallic	Please check with your Retailer for availability	'	○	-	○	○	575.00	690.00
Available in: designo diamond white metallic 799 designo hyacinth red metallic 996								
Paint – designo selenite grey magno		727	○	-	○	○	1,662.50	1,995.00
Trim – AMG carbon fibre		H73	○	-	●	●	2,133.33	2,560.00
Trim – high-gloss black ash wood		736	○	-	○	○		no-cost option
Trim – dark longitudinal-grain aluminium		H76	●	-	○	○		no-cost option
Trim – high-gloss brown burr walnut wood		731	○	-	○	○		no-cost option
Trim – light longitudinal-grain aluminium		739	○	-	○	○		no-cost option
Trim – satin-finish light brown poplar wood		729	○	-	○	○		no-cost option
Upholstery – nappa leather	Please note that nappa leather is not perforated, except in conjunction with comfort-ventilated seats (code 401) or AMG sports seats	'	○	-	●	-	591.67	710.00
Upholstery – Exclusive nappa leather		'	-	-	○	●	2,116.67	2,540.00

Item	Notes		AMG Line	designo Edition	Mercedes-AMG SL 63	Mercedes-AMG SL 65	Basic RRP excl. VAT (£)	Total RRP incl. VAT (£)
Paint, Trim and Upholstery (continued)								
Upholstery – designo seat belts		-	-	-	○	○	350.00	420.00
Available in: silver Y04 red Y05								
Comfort								
KEYLESS-GO Comfort package The vehicle can be conveniently opened, started and locked with this access and drive authorisation system – simply by carrying the electronic key. The automatic boot separator electrically lowers the boot separator into position. Remote boot opening and closing makes it possible to open and close the boot lid by pressing a button in the driver’s door, on the boot lid, or by using the remote control button on the key		P17	○	○	○	●	1,337.50	1,605.00
AIRSCARF – neck-level heating Through air outlets in the head restraints, pleasantly warm air is ‘wrapped’ around the necks of the driver and passenger like an invisible scarf. The desired temperature can be set in three stages		403	○	●	○	●	479.17	575.00
Ambient lighting LED lighting located in the centre console, armrest and footwell. Offers a choice of three colours: solar red, polar blue and polar white. The lighting can be dimmed to suit personal tastes		877	○	●	●	●	216.67	260.00

Item	Notes		AMG Line	designo Edition	Mercedes-AMG SL 63	Mercedes-AMG SL 65	Basic RRP excl. VAT (£)	Total RRP incl. VAT (£)
Comfort (continued)								
Closing aid for doors When initially engaged, the doors are automatically closed by servo motors, ensuring smooth and virtually silent closing		883	○	○	○	●	262.50	315.00
Comfort-ventilated seats	Supplied with perforated leather	401	○	●	○	●	620.83	745.00
Cup holders in centre console Includes bottle holder in rear stowage compartment		309	○	○	○	○	62.50	75.00
Illuminated door sill panels		U25	○	○	●	●	179.17	215.00
Panoramic vario-roof with MAGIC SKY CONTROL The panoramic roof changes from dark to transparent or vice versa within a few seconds. In its tinted state, it substantially reduces heating-up of the vehicle interior		412	○	○	○	●	1,562.50	1,875.00
Reversing camera		218	○	○	○	○	220.83	265.00
Seats – Active Multi-Contour Seat package with massage function Thanks to their inflatable air chambers, the active multicontour seats with massage function and dynamic function ensure optimum seating comfort and excellent lateral support. Includes Neck-Pro luxury head restraints with adjustable side bolsters. Especially on long journeys, the massage function with seven zones and two selectable intensity settings helps to avoid muscle tension	Only available in conjunction with comfort-ventilated seats (code 401)	432	○	●	-	-	1,437.50	1,725.00
		-	-	○	○		604.17	725.00
Wind deflector – electrically operated This can be extended or retracted by either the driver or the passenger, even while on the move, by simply pressing a button. When retracted, it disappears completely into the rear compartment trim cover		285	○	○	○	○	437.50	525.00

Item	Notes	386	AMG Line	designo Edition	Mercedes-AMG SL 63	Mercedes-AMG SL 65	Basic RRP excl. VAT (£)	Total RRP incl. VAT (£)
Communications and In-Car Entertainment								
Convenience telephony In the armrest with universal interface for various mobile phone cradles, extended telephone function, charging function and connection to LTE-compatible external aerial for optimum reception and data transfer. A separate cradle for your mobile phone needs to be ordered as an accessory from your Retailer	Works in conjunction with the multifunction steering wheel and display. The phone cradle is mounted in the front centre armrest. It is recommended that a compatible handset is sourced prior to ordering a cradle	386	○	○	○	●	291.67	350.00
Surround sound system – Bang & Olufsen BeoSound AMG High-end sound system with 12 speakers and Frontbass, speaker covers in aluminium, two LED-illuminated tweeters featuring Acoustic Lens Technology, ICEpower amplifier, 900 watt output		811	○	○	○	●	4,220.83	5,065.00
Surround sound system – Harman Kardon® Logic 7® 10-channel DSP amplifier with 11 high-performance speakers and Frontbass, 600 watt output		810	○	○	○	-	958.33	1,150.00
Service Package								
Service Care Service Care allows you to spread the cost of servicing your new car in the Mercedes-Benz Retailer network. Taking out a Service Care plan ensures your servicing needs are taken care of by fully trained Mercedes-Benz Technicians with the added benefit of a Mercedes-Benz service history	Price is based on a monthly rate. Example given is for two services taken over 24 months or three services over 36 months. Further payment options are available. New Service Care prices apply only to vehicles up to 12 months old prior to first service. Prices effective from 3 May 2016	1	○	○	-	-	34.16	41.00
			-	-	○	○	37.50	45.00

Genuine Accessories

We've developed a range of Accessories you can add to help personalise and enhance your SL. Your local Mercedes-Benz Retailer can advise on fitting costs of Accessories, where applicable. Further information on our full range of Genuine Accessories can be found on the Mercedes-Benz UK website.

01 | Shallow boot tub

The boot tub is suitable for transporting shopping. The tub shape with its slightly raised edge is precision-tailored to the load area. Made from impact-resistant, non-split polypropylene.

RRP £88.50 (incl. VAT)



02 | Concertina load sill protector

Protects the rear of the car from scratches when you're loading the vehicle – and prevents dirt from the car from getting onto your clothes. Practical design – can be connected to shallow boot tub or reversible mat.

RRP £40.50 (incl. VAT)

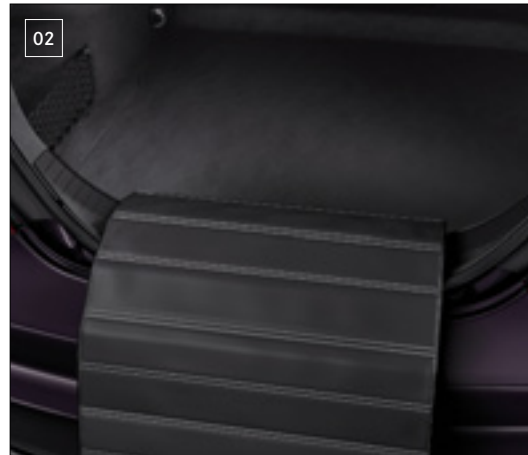

03 | Illuminated door sill panels

A sparkling highlight for your Mercedes-Benz: the blue or white illuminated Mercedes-Benz lettering is activated every time you open the door to get in or out. Made from stainless steel.

RRP £359.50 (incl. VAT) per pair, excluding fitting



Colours and materials

Metallic paints

Standard



Non-metallic paint

No-cost option



designo metallic paints

Additional-cost option



designo magno paint

Additional-cost option



¹Standard on designo Edition, no other options available ²Please check with your Retailer for availability

Please note that, owing to limitations of on-screen representation, paint colours may differ from those shown



Leather

AMG Line¹



201 black



205 ginger beige/espresso brown



207 bengal red



211 black with vertical fluting

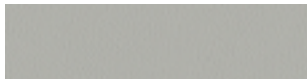

218 crystal grey/black

Nappa leather

Mercedes-AMG SL 63¹/AMG Line²



801 black

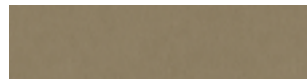

805 ginger beige/espresso brown



807 bengal red



811 black with vertical fluting³



814 saddle brown/black³

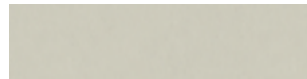

815 porcelain

Exclusive nappa leather

Mercedes-AMG SL 65¹/SL 63²



501 black

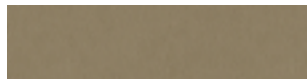

505 ginger beige/espresso brown



507 bengal red

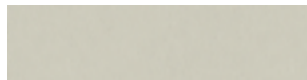

515 porcelain

designo nappa leather

designo Edition¹

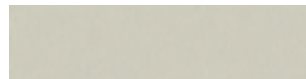

X27 porcelain/black⁴

Trim



729 satin-finish light brown poplar⁵



731 high-gloss brown burr walnut⁵



736 high-gloss black ash⁵



739 light longitudinal-grain aluminium⁵



H76 dark longitudinal-grain aluminium



H73 AMG carbon fibre⁶



W70 designo porcelain piano lacquer⁴

¹Standard ²Additional-cost option ³AMG Line only ⁴Standard on designo Edition; no other options available ⁵No-cost option ⁶Additional-cost option for AMG Line

Trim and upholstery combinations

	AMG Line				AMG Line/Mercedes-AMG SL 63/Mercedes-AMG SL 65				
	Leather ¹				Nappa leather ² /Exclusive nappa leather ³				
	black (201/211)	ginger beige/ espresso brown (205)	bengal red (207)	crystal grey/ black (218)	black (801/811 ⁴ /501)	ginger beige/ espresso brown (805/505)	bengal red (807/507)	saddle brown/ black ⁴ (814)	porcelain (815/515)
Dashboard									
Steering wheel	black	espresso brown	black	black	black	espresso brown	black	black	black
Upper dashboard trim	black	espresso brown	black	black	black	espresso brown	black	black	black
Lower dashboard trim	black	beige	bengal red	crystal grey	black	ginger beige	bengal red	black	porcelain
Seats									
Seat cushion centre section	black	beige	bengal red	crystal grey	black	ginger beige	bengal red	saddle brown	porcelain
Side bolster trim	black	beige	bengal red	crystal grey	black	ginger beige	bengal red	saddle brown	porcelain
Head restraint	black	beige	bengal red	crystal grey	black	ginger beige	bengal red	saddle brown	porcelain
Doors									
Door centre panel	black	beige	bengal red	crystal grey	black	ginger beige	bengal red	saddle brown	porcelain
Door trim at beltline	black	espresso brown	black	black	black	espresso brown	black	black	black
Roof lining	grey/black	beige	black	grey	black	ginger beige	black	black	black
Parcel shelf	black	espresso brown	black	black	black	espresso brown	black	black	black
Floor covering									
Front and rear	black	beige	black	black	black	ginger beige	black	black	black
Boot	black	beige	black	black	black	black	black	black	black



Combination options

Leather/nappa leather/Exclusive nappa leather ²		Metallic paints Standard						Non-metallic paints No-cost option	designo paints Additional-cost option		
		183 magnetite black	197 obsidian black	526 dolomite brown	775 iridium silver	896 brilliant blue	992 selenite grey	149 polar white	297 selenite grey magno	799 diamond white metallic ¹	996 hyacinth red metallic
	black	●	●	●	●	●	●	○	●	●	●
	ginger beige/espresso brown	○	●	●	△	○	○	●	○	●	●
	bengal red	●	●	△	●	△	●	●	●	●	△
	crystal grey/black	●	●	△	●	●	●	●	●	●	●
	saddle brown/black	●	●	△	●	○	●	●	●	●	○
	porcelain/black	●	●	●	△	●	○	●	○	●	●

Technical data

		Petrol engines			
Model		SL 400	SL 500	Mercedes-AMG SL 63	Mercedes-AMG SL 65
Engine					
Total displacement	cc	2,996	4,663	5,461	5,980
Arrangement/cylinders/valves		V/6/24	V/8/32	V/8/32	V/12/36
Power ¹	hp (kW) at rpm	367 (270)/5,500-6,000	455 (335)/5,250	585 (430)/5,500	630 (463)/4,800-5,400
Torque ¹	Nm at rpm	500/2,000-4,200	700/1,800-3,500	900/2,250-3,750	1,000/2,300-4,300
Compression ratio		10.5:1	10.5:1	10.0:1	9.0:1
Transmission					
9G-TRONIC PLUS 9-speed automatic		●	●	-	-
AMG SPEEDSHIFT MCT 7-speed automatic		-	-	●	-
AMG SPEEDSHIFT PLUS 7G-TRONIC auto.		-	-	-	●
Tyres sizes					
Front		255/35 R 19	255/35 R 19	255/35 R 19	255/35 R 19
Rear		285/30 R 19	285/30 R 19	285/30 R 19	285/30 R 19
Rear - designo Edition		285/30 R 20	285/30 R 20	-	-

Model	Petrol engines			
	SL 400	SL 500	Mercedes-AMG SL 63	Mercedes-AMG SL 65

Performance

Acceleration 0–62 mph	sec	4.9	4.3	4.1	4.0
Top speed	mph	155 ²	155 ²	155 ² (186 ³)	155 ² (186 ³)

Weights and capacities

Kerb weight	kg	1,735	1,795	1,845	1,950
Perm. Gross Vehicle Weight	kg	2,115	2,175	2,180	2,210
Boot capacity with roof closed	l	485	485	485	485
with roof open		364	364	364	364
Fuel tank capacity/of which reserve	l	65/8	65/8	75/14	75/14
Turning circle	m	11.04	11.04	11.04	11.04

Fuel consumption^{4,5}

	mpg				
Urban		26.9	22.8	20.2	16.2
Extra-urban ⁶		47.1	40.4	37.7	32.1
Combined		36.7	31.4	28.8	23.7

²Electronically limited

³In conjunction with optional AMG Driver's Package (code 250 for Mercedes-AMG SL 63 and Mercedes-AMG SL 65)

⁴All figures are based on a standard specification with the smallest tyre size

⁵The choice of wheels may affect CO₂ emissions and corresponding Road Fund Licence

⁶EUDC: extra-urban driving cycle. Testing procedures adhere to EU Directive 93/116

Model	Petrol engines			
	SL 400	SL 500	Mercedes-AMG SL 63	Mercedes-AMG SL 65

CO ₂ emissions ⁵	g/km			
Emissions standard	EU6	EU6	EU6	EU6
19" alloy wheels (285/30 tyres)	175	205	229	-
20" alloy wheels (285/30 tyres)	-	-	234	279

Insurance				
Group rating	50A	50A	50A	50A

Insurance ratings may vary depending on model line and specification. Please refer to <http://www.thatcham.org/abigrouprating/> for further details

⁵The choice of wheels may affect CO₂ emissions and corresponding Road Fund Licence



> View offers



> Book a test drive



> Find a Retailer



> View the Range Guide

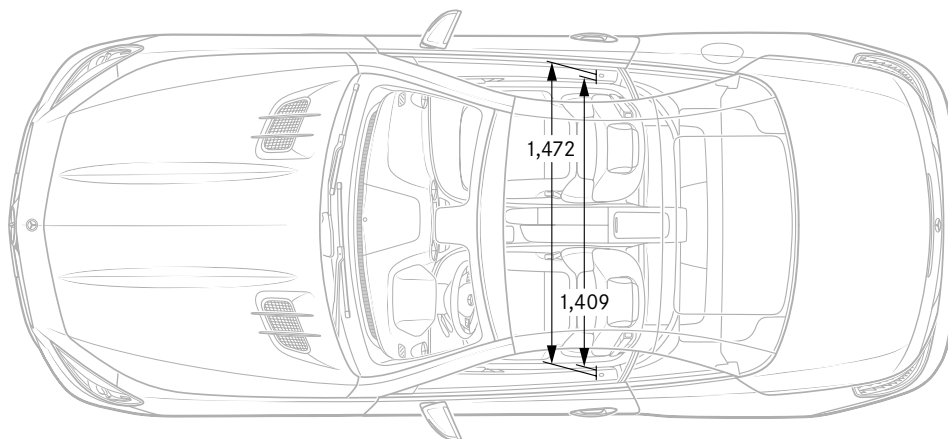
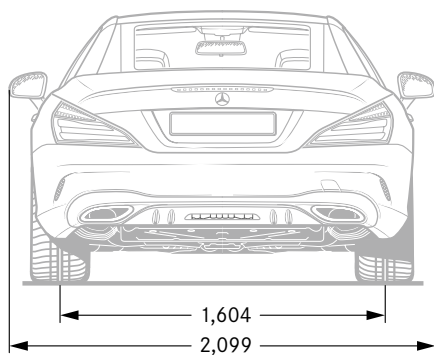
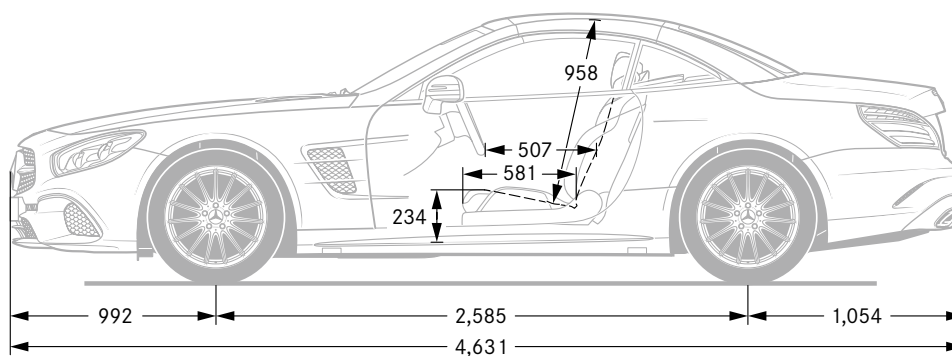
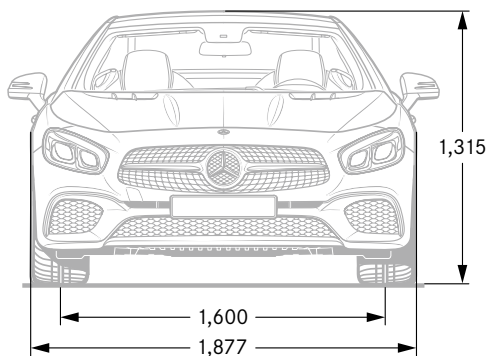

All measurements in millimetres. The dimensions shown are mean values and apply to standard-specification, unladen vehicles. Illustrations may differ from current specification
 The figures on pages 58-61 are correct at time of publication. Please refer to the government website for latest data - <http://carfueldata.direct.gov.uk/>

Road Fund Licence



All road vehicle registrations are subject to Vehicle Excise Duty (Road Fund Licence), which varies in accordance with the vehicle's CO₂ emissions. A first year rate for each taxation band will apply. The table below shows the bands (A–M) created by the DVLA and the corresponding Road Fund Licence. CO₂ emissions are listed in the technical data on page 60, and the relevant Excise Duty is reflected in the on-the-road prices on page 15.

Band	CO ₂ emissions	First year rate (£)	Standard rate (£)	Premium rate (£) ¹
A	0 g/km	0.00	0.00	310.00
B	1 to 50 g/km	10.00	140.00	450.00
C	51 to 75 g/km	25.00	140.00	450.00
D	76 to 90 g/km	100.00	140.00	450.00
E	91 to 100 g/km	120.00	140.00	450.00
F	101 to 110 g/km	140.00	140.00	450.00
G	111 to 130 g/km	160.00	140.00	450.00
H	131 to 150 g/km	200.00	140.00	450.00
I	151 to 170 g/km	500.00	140.00	450.00
J	171 to 190 g/km	800.00	140.00	450.00
K	191 to 225 g/km	1,200.00	140.00	450.00
L	226 to 255 g/km	1,700.00	140.00	450.00
M	over 255 g/km	2,000.00	140.00	450.00

¹Premium rate only applicable to vehicles where the list price is over £40,000 including any factory-fitted options, standard UK delivery charge, number plates, fuel and VAT

Services and insurance

Mercedes-Benz Service Care

We believe that servicing costs should be as flexible and affordable as possible for your SL, which is why we offer Service Care, an easy way to budget for all your servicing costs. It spreads your bills into manageable payments based on whether you have a new or used Mercedes-Benz.

With Service Care we guarantee the price of parts and labour for up to three services and safeguard against any further inflation. It also covers the cost of all recommended service items including brake fluid, spark plugs, air filters, fuel filters and screen wash.

You can choose either to add your servicing costs into your monthly spend or pay the full amount in a one-off payment, giving you peace of mind that they are taken care of for the period of the plan.

To receive a personalised Service Care plan recommendation visit the Service Care Calculator at servicecarerates.mercedes-benz.co.uk

Warranty and breakdown cover

Every Mercedes-Benz comes with a three-year unlimited mileage warranty against manufacturing or material defects¹ and up to 30 years warranty against perforation due to corrosion from the inside out². What's more, it's also covered by Mercedes-Benz Roadside Assistance – a unique package comprising up to 30 years pan-European breakdown assistance².

Insurance

Since our name is synonymous with reliability, who better to trust with your motor insurance? Mercedes-Benz Insurance provides a motor insurance policy specifically designed to give you the cover you would expect from Mercedes-Benz. For a motor insurance quotation, call **0345 600 2180**.*

Mercedes me connect

Mercedes me connect enables you to connect to your car via desktop, tablet or smartphone via an app. It provides access to services that enhance your Mercedes-Benz experience and fit effortlessly into your daily digital routine.¹

Standard Services.

Available on all models, except G-Class.

- **Emergency Call** – if there's an accident, this feature automatically shares your vehicle location and status for a fast response from the emergency services
- **Accident & Breakdown Management** – contact our Customer Assistance Centre with a single button for fast breakdown recovery
- **Telediagnosics** – automatically detects and shares details of any vehicle wear and tear with you, and shares the data with your Retailer
- **Maintenance Management** – reminds you when your service is due and automatically shares maintenance data with your Retailer
- **Parking Time Assist** – track the time on your parking meter and receive an alert when it's due to expire



Vehicle Setup.

These services come as standard if you have COMAND Online. Available as an optional £69 upgrade for all other customers.

- **Personal Profile** – store your preferences, such as your favourite radio stations and apps, to create your personal driver profile
- **Maintenance (Vehicle Status)** – check safety information, such as coolant level and brake pad condition, so you can be sure your car is safe and ready to drive
- **Remote Door Unlock** – lock and unlock your car remotely, wherever you are in the world
- **Send to Car Function** – search for destinations on your smartphone, tablet or desktop, then send the routes direct to your car for navigation

¹Currently unavailable in the Channel Islands and the Isle of Man

Remote Online Services.

Standard on all models with COMAND Online, except for new E-Class. Available to purchase for an additional £150.00 (incl. VAT) for all models without COMAND Online.

- **Trip information and vehicle status** – access the vehicle's trip data such as fuel level, mileage, condition of brake pads and tyre pressure
- **Remote door locking and unlocking** – lock and unlock your car remotely, wherever you are in the world
- **Geofencing** – set up a geographical boundary and receive alerts whenever your car enters or leaves this area
- **Parked Vehicle Locator** – locate your parked vehicle within a range of one mile and plot a route back to it
- **Vehicle Tracker** – track the location of your car anywhere in the world

Additional services for Plug-In Hybrid and electric models only, as part of Remote Online services:

- **Pre-entry climate control** – activate the pre-entry climate control system of your parked vehicle and set the temperature to your liking before boarding
- **Route planning** – displays the electric operating range on a map and enables you to plan a route while stopping at public charging stations
- **Charging points** – displays a list of the nearest public charging stations
- **Charging profile** – control the charging settings from a distance so your vehicle can be ready charged when you need it

Vehicle Monitoring.

Standard with COMAND Online for all models, except the new E-Class. Available to purchase for new E-Class and all other customers as an additional £69 upgrade.

- **Geo-fencing** – set up a geographical boundary and receive alerts whenever your car enters or leaves this area
- **Parked Vehicle Locator** – locate your parked car when within 1 mile and plot a route back to it
- **Vehicle Tracker** – track the location of your car anywhere in the world

Visit the Mercedes me connect store for more information:

shop.mercedes-benz.com/en-gb/connect

Mercedes-Benz Finance

Why should you finance with Mercedes-Benz?

At Mercedes-Benz we believe a great driving experience should be matched by an equally great ownership experience. That is why we put just as much thought, time and effort into designing our finance options, our service plans and our insurance cover as we do into our vehicles.

We are not in the business of simply providing a loan to fund the purchase of your dream vehicle. We look on it as a journey that we take with you, from the moment you choose your new Mercedes-Benz, to helping you in choosing your next one.

If you would like to find out more about any of our current offers, simply call into your local Mercedes-Benz Retailer where one of our Business Managers will be more than happy to talk you through anything you need to know.

Helping you find the right solution.

You should find our finance packages are more convenient than a traditional personal loan because:

- Funds are immediately available – no waiting for cheques or loans to clear.
- There is no security required – either against your home or other assets.
- We have clear and transparent rates – the APR we quote is the APR you get.
- We have friendly Business Managers – experts in vehicle finance who can talk you through all of your plans in detail.

One of our most popular finance products is Mercedes-Benz Agility (our Personal Contract Purchase product). We also offer Contract Hire, Operating Lease and Hire Purchase solutions. If you would like to find out more about these speak to your Retailer or visit www.mercedes-benz.co.uk/fandi.

Mercedes-Benz Agility (our PCP product).

At the start of an Agility agreement, you put down a deposit and decide the term of your agreement and your annual mileage. You will be advised of the Guaranteed Future Value, which offers you the reassurance of knowing exactly what you will need to pay to own the vehicle outright in the future (this is known as the Optional Purchase Payment).

Throughout your agreement you simply pay your agreed monthly payments and when the agreement comes to an end you either purchase, hand back or part-exchange your vehicle.



Agility features:

- Fixed regular payments mean you can easily budget.
- Payments are based only on a proportion of the vehicle's value, keeping your monthly payments lower.
- Our Guaranteed Future Value avoids the risk of unplanned depreciation of your vehicle.
- You defer your ownership decision until the end of the agreement.

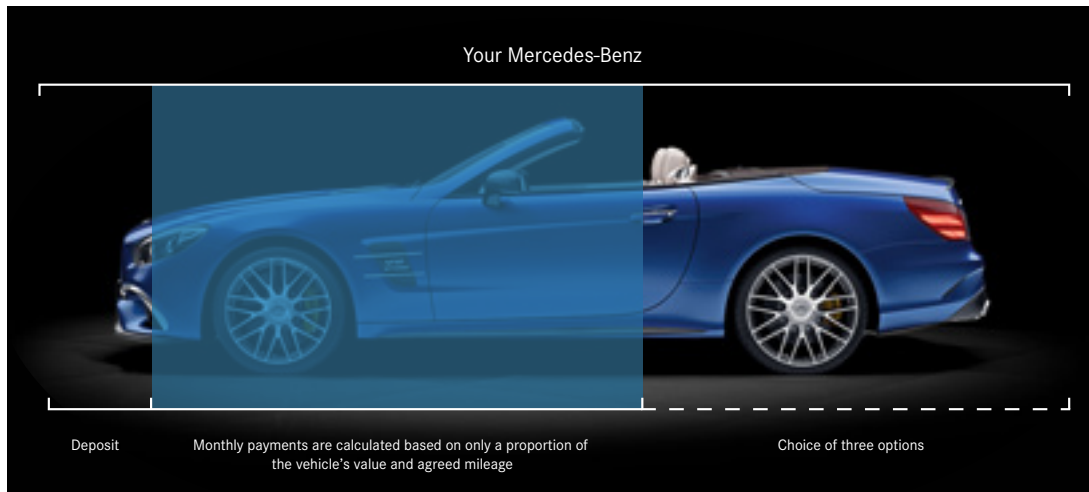

At the end of your agreement you have three options to choose from.

Option 1: Purchase your Mercedes-Benz.

Purchase your Mercedes-Benz by paying the Optional Purchase Payment and Purchase Activation Fee.¹ This will complete the purchase of your Mercedes-Benz, leaving you free to simply enjoy your vehicle.

Option 2: Hand back your Mercedes-Benz.

If you decide to return your vehicle to us, it must be in line with our Vehicle Return Standards,^{*} as vehicle condition, excess mileage and other charges may be payable.

Option 3: Part-Exchange for a new vehicle.

Purchase your Mercedes-Benz by paying the Optional Purchase Payment and Purchase Activation Fee.¹ This will complete the purchase of your Mercedes-Benz, leaving you free to part-exchange for a new vehicle.

¹Please note the 'Purchase Activation Fee' of £10 will be debited from your account *To find out more information about our Vehicle Return Standards please visit <http://mercedes-benz.co.uk/vrs>

 > View offers

 > Book a test drive

 > Find a Retailer

 > View the Range Guide

Follow us on the following social media channels:

 facebook.com/mercedesbenzuk

 twitter.com/mercedesbenzuk

 youtube.com/mercedesbenzuk

 instagram.com/mercedesbenzuk

Effective from 1 June 2017 Production. Information correct at time of publication.

Prices and specifications are subject to change without prior notice.

MBR231PL/0717 MY 808 Production from 01.06.2017

Mercedes-Benz Cars UK Limited, Tongwell, Milton Keynes, MK15 8BA. Company number 2448457 www.mercedes-benz.co.uk