



Commercial
Vehicles

The Transporter



Contents.

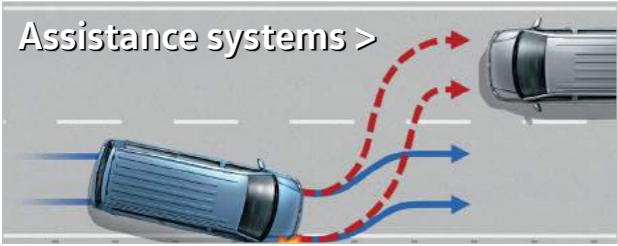

Volkswagen Commercial Vehicles' Van Centres. Working with you.

It's more than a van to you. You're more than a customer to us. We know that when you choose Volkswagen Commercial Vehicles, you're looking for more than just four walls on four wheels. You want a van that looks after itself while you take care of business. A vehicle that makes a statement, as well as a delivery. An investment for the future that makes a difference today.

To us, you're a partner. By being there to get to know how you work and what you need, we can offer you more – supporting your plans year after year. It means a partnership that lasts as long as your ownership, with a vehicle and a team that's with you for the journey.

Our dedicated network of Van Centres. Over **70 Van Centres** and **24 Authorised Repairers** means you're only around 45 minutes on average from our door.



Everything for the job... ..and the journey.

The right van. We're commercial vehicle experts and finding the right van for your business is what makes us tick. We'll guide you through the range, take you on a test drive and cover all the options.

The right accessories. From mudflaps to sat navs, plying to roof racks, we'll work with you to create the perfect van – keeping everything 100% Volkswagen to aid high residuals.

The right finance. Every business is different, so we stay flexible, with a range of finance packages to choose from. Depending on your preference, we'll go through the options to find the one that suits you best.

The right support. Nothing matters more than keeping you mobile, so our servicing options are built around you. You'll also enjoy three-years' free Roadside Assistance with your new van.

The right service. We understand it's the little things that make the difference, so we set high standards. We'll call you when we say, keep you informed on delivery dates and support you long after purchase.

And there's more... We offer a lot more than you might think. From **cost-effective van rental** or an **air conditioning recharge**, to a wide selection of premium and budget **replacement tyres**, if we're not able to help, we'll try and point you in the right direction!

For more information on accessories, finance, service, support and warranties, please refer to the Service and warranties section.





Model shown is Transporter Kombi.

Professional from every angle. Design.

The Transporter succeeds in catching the eye. With its assured styling and defined contours giving the design a striking look, the Transporter makes a real statement. While the front delivers a bold stance with purposeful headlights and bumper, the rear features elegantly sculptured rear light clusters. Additional highlights include a chrome strip on the radiator grille, stylish side indicators and a range of attractive alloy wheels.



17" Devonport alloy wheels – from our range of stylish alloy wheels.



Optional low energy LED rear light clusters.



Optional low energy LED headlights.

Style, comfort and quality.

Interior.



Designed to impress, the Transporter is packed with features that benefit comfort, convenience and offer assistance while you work. Step inside and you'll find a stylish dashboard with plenty of storage solutions and a quality finish. Everything within the cab has been carefully thought through – from ergonomic seating, to controls and functions that are arranged to be within easy reach.

Combining the use of robust materials and meticulous production methods, the Transporter's interior is designed to stand the test of time. Add to this a broad selection of radio and infotainment systems featuring up-to-the-minute technology – including standard DAB+ radio and Bluetooth®, not to mention the latest advances in safety, and you'll discover the Transporter is a comfortable and enjoyable place to spend your working day.

Radio and infotainment.



Optional Composition Media DAB+ radio system.

Radio and navigation.

The latest-generation devices are available, including the standard Composition Colour touch-screen DAB+ radio system, optional Composition Media DAB+ radio system, as well as the optional Discover Media navigation system.

Voice control.¹

Available as an option, the voice control system allows you to operate the telephone, navigation and audio functions without taking your hands off the steering wheel.

App-Connect.²

Available as an option with the Composition Media DAB+ radio system or Discover Media navigation system. App-Connect allows you to operate certain apps by 'mirroring' the screen of your smartphone on the radio system's colour touch-screen display. Standard on the new Transporter Edition model.

Connectivity.

Available as an option with the Composition Media DAB+ radio system or Discover Media navigation system. External media devices, such as MP3 players, can be connected via an additional USB port. Furthermore, the standard mobile phone interface offers a Bluetooth® hands-free speaking system.

1 The 'Voice' control button on the optional Composition Media DAB+ radio system or Discover Media navigation system is only enabled when ordered in conjunction with the optional Voice control system.

2 The 'App' control button on the optional Discover Media navigation system is only enabled when ordered in conjunction with the optional App-Connect system.

Your safety is our priority. Safety systems.

Your safety is vital, so we ensure that a long list of safety and security features are built into every vehicle we produce. Since we first introduced structural safety features on commercial vehicles over 35 years ago, Volkswagen has maintained a policy of continuous safety development. Every Volkswagen model incorporates a range of both active and passive safety features, to help ensure the safety and security of both you and your load.

With the vehicle's design contributing to safety, occupants are securely enclosed within a rigid safety cell with crumple zones to absorb crash energy, while the chassis and suspension are designed for excellent directional stability and handling. Features such as Anti-lock Braking System (ABS), Electronic Brakeforce Distribution (EBD), Electronic Stabilisation Programme (ESP), driver and passenger front airbags, electric seatbelt tensioners, Automatic Post-Collision Braking System and Front Assist with City Emergency Braking are fitted as standard.

For additional security and protection, an electronic immobiliser and remote central locking with dead locking and internal locking button are standard, while optional features such as anti-theft devices, front and rear parking sensors, LED headlights, 4MOTION all-wheel drive, automatic rain-sensing wipers and front fog lights with integrated cornering lights all offer additional peace-of-mind.



Electronic Stabilisation Programme (ESP).

Designed to prevent the vehicle from swerving in critical driving conditions by controlled and targeted intervention in the brake and engine management. This helps to maximise directional stability.



Anti-lock Braking System (ABS).

Designed to prevent wheels from locking up and assist manoeuvrability of the vehicle under heavy braking.



Traction Control System (TCS).

Aids smooth starts and acceleration by reducing wheel-spin. The system also incorporates the Electronic Differential Lock (EDL) and makes up part of the Electronic Stabilisation Programme (ESP).



Electronic Differential Lock (EDL).

Allows smooth starts on slippery or loose road surfaces. If one wheel starts to spin, EDL is designed to brake the wheel as necessary, directing power to the wheel with greater traction.



Airbags.

Driver and passenger front airbags are standard. They offer occupants improved protection in the event of head-on impacts.



Seatbelt warning.

The seatbelt warning reminds the driver that their seatbelt is not fastened. Audio and visual signals are used to request that the seatbelt is fastened before driving.

Watch video >



Automatic Post-Collision Braking System.

Standard on all Transporter models, it triggers braking after a collision, with the aim of preventing secondary collisions.

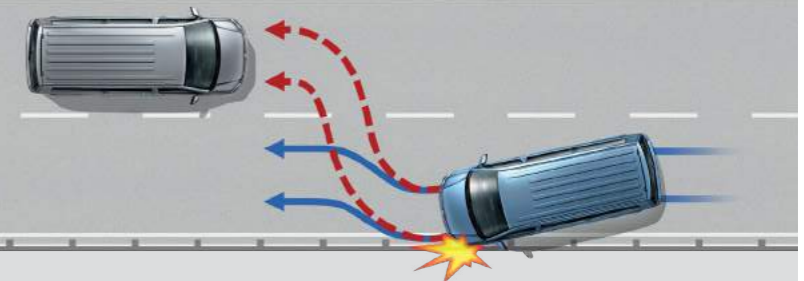

Prepared for any scenario.

Driver assistance systems.

To help ensure every journey ends as stress-free as it begins, the Transporter is equipped with a number of systems – all of which are activated in critical situations as a preventative measure. Add to this a variety of innovative driver assistance systems and you'll discover the Transporter offers high levels of safety and peace-of-mind.



Optional parking sensor display.



Optional rear-view camera display.



Cruise control.

Available as an option, cruise control maintains the selected speed.



Brake Assist.

Fitted as standard, the system registers the speed at which the brake pedal is pressed. During emergency braking, it helps ensure full brake pressure is applied more quickly.



Hill Hold Assist.

Fitted as standard, the convenient Hill Hold Assist helps to prevent your vehicle from rolling back when pulling away on an incline. The hold operates for approximately two seconds.



Driver Alert System.

Fitted as standard, the Driver Alert System registers deviation from normal steering patterns and uses visual and acoustic warnings to recommend that the driver takes a break.



Daytime running lights.

Fitted as standard, daytime running lights offer increased visibility. For extra driver convenience, the dipped beam headlights are automatically switched on when you start your vehicle.



Tyre pressure monitoring.

The optional tyre pressure monitoring display (standard on kombi) activates a warning signal to highlight significant changes in tyre pressure. This lets the driver know that the tyre pressure should be checked as soon as possible.

An intelligent driving experience. Assistance when you need it.

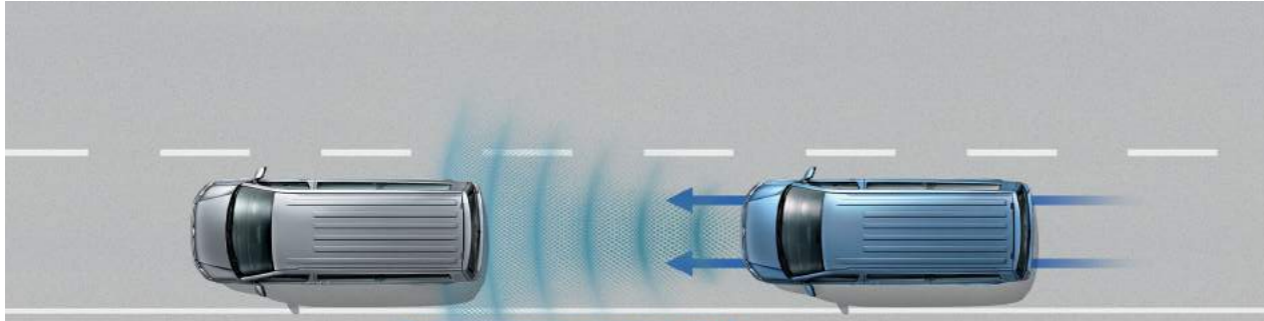

Front Assist with City Emergency Braking System.

The standard Front Assist area monitoring system with City Emergency Braking System detects critical distances, warns of hazardous situations and when necessary, triggers emergency braking.



Adaptive Cruise Control (ACC).

Available as an option, Adaptive Cruise Control (ACC) uses a front radar to measure the distance (up to 120m) and speed relative to vehicles driving ahead. It automatically regulates the pre-set distance.

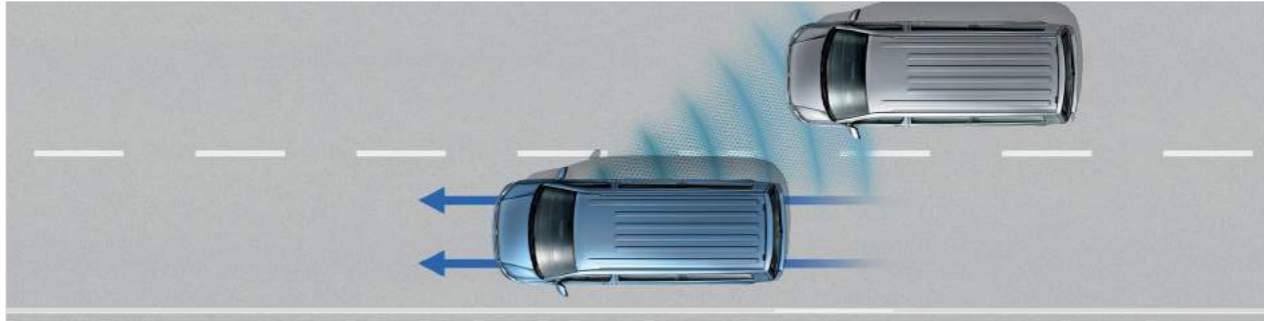

Lane Change Assist - Side Scan.

Available as an option on short wheelbase models only, Side Scan displays a warning signal on the exterior mirror as soon as one of its sensors detects a vehicle in a blind spot during a lane change.



High Beam Assist.

Available as an option, High Beam Assist automatically dips the headlights and prevents dazzle for oncoming vehicles, or vehicles travelling ahead. At night time at speeds of above 37mph, the system automatically switches the headlights to high-beam.

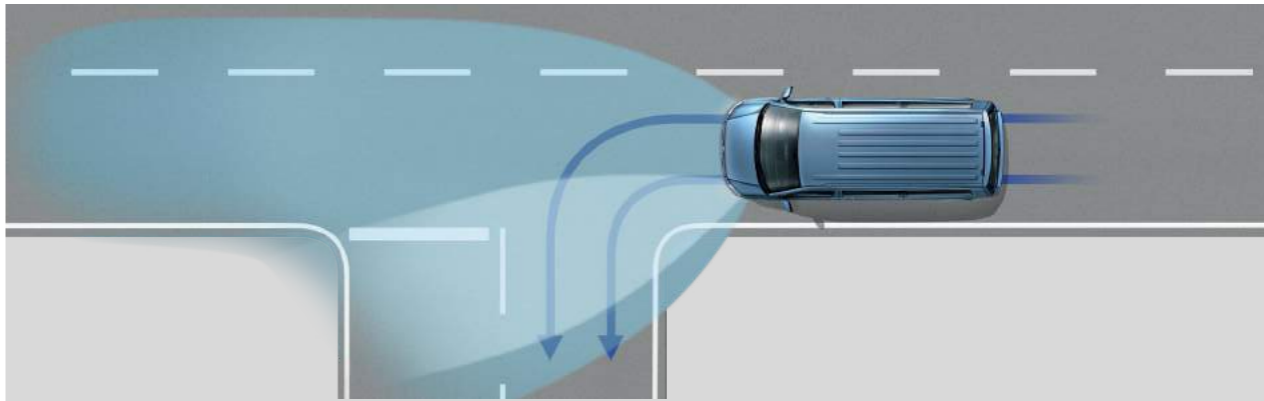

Fog lights with integrated cornering lights.

Available as an option, these help to illuminate curves and bends in the road ahead. This aids the driver in spotting any obstacles where the vehicle is turning.



Get to grips with hard work. 4MOTION all-wheel drive.

The Transporter offers a number of innovative features to help retain traction, optimum handling and outstanding steering response when encountering poor surface conditions.

4MOTION all-wheel drive.

The advantage of the Haldex clutch for the 4MOTION all-wheel drive is an improvement to vehicle handling and dynamics.

4MOTION all-wheel drive with DSG.

The Transporter is the only vehicle in its class that's available with 4MOTION all-wheel drive and a 7-speed, dual clutch direct shift gearbox (DSG). Available as an option, this combination enables smooth driving on rugged terrain, thanks to its fully automatic gear changes.

Mechanical differential lock.

The optional mechanical differential lock is available for the rear axle together with optional 4MOTION all-wheel drive. This helps to maintain traction when you encounter adverse conditions, such as rain, snow, mud or gravel.

Helping to make work easier.

Rear door solutions.

With two wheelbases and three roof heights, there's plenty of choice when it comes to space and access. What's more, with its legendary build-quality, together with robust hinges, handles and locks, all Transporters are designed to take the rigours of the working day in their stride. We also know that flexibility is important for any business, so every Transporter is available with a choice of either a large tailgate or versatile rear wing doors – with the option to specify 250° opening angle hinges on long wheelbase models. Both are available glazed or in solid metal for added security. With a low load bed, combined with a generous rear opening width of 1,473mm and maximum load height of 1,940mm for high roof models, you'll discover that whichever solution you choose, the Transporter is designed to make load access easy and convenient.



Rear wing doors with heated windows. Optional on kombi.



Tailgate with window. Standard on kombi, no cost option on panel van.



Tailgate without window. No cost option for panel van and kombi.



High roof featuring high rear wing doors with windows. Optional on kombi.



Optional high roof featuring high rear wing doors without windows.

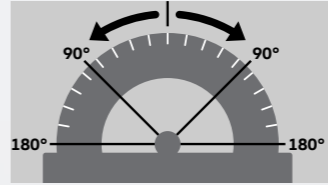

Rear wing doors with optional 250° opening angle for long wheelbase models.



Image shown features rear wing doors without windows which are standard on panel van. Image also shows 250° opening angle hinges which are optional on long wheelbase models.

The space to tackle large and difficult jobs. Load space solutions.



All Transporter models provide a spacious load compartment with volumes ranging from 5.8m³ for the short wheelbase low roof, to 9.3m³ for the long wheelbase high roof. If you require the flexibility to carry both cargo and crew, then the versatile kombi is the answer. With its rear seats removed, the kombi offers near identical levels of usable space. While the standard specification includes multiple load-lashing rings, sturdy painted load floors on panel vans and rubber floor coverings on the kombi. It's the Transporter's range of optional bulkheads, robust load floor coverings, storage solutions, ventilation and electrical upgrades – not to mention its range of Volkswagen accessory 'Add Ons', that help it to tackle virtually any job.

Space for up to 3 Euro-pallets

- Up to 9.3m³ load compartment volume
- Up to 1,301kg payload
- Up to 1,940mm loading height
- Up to 2,500kg trailer weight
- Up to 2,975mm load compartment length



- 01 Rubber load floor covering (standard on kombi) with load-lashing rings.
- 02 Optional full-height bulkhead with window.
- 03 Optional load compartment heating system.

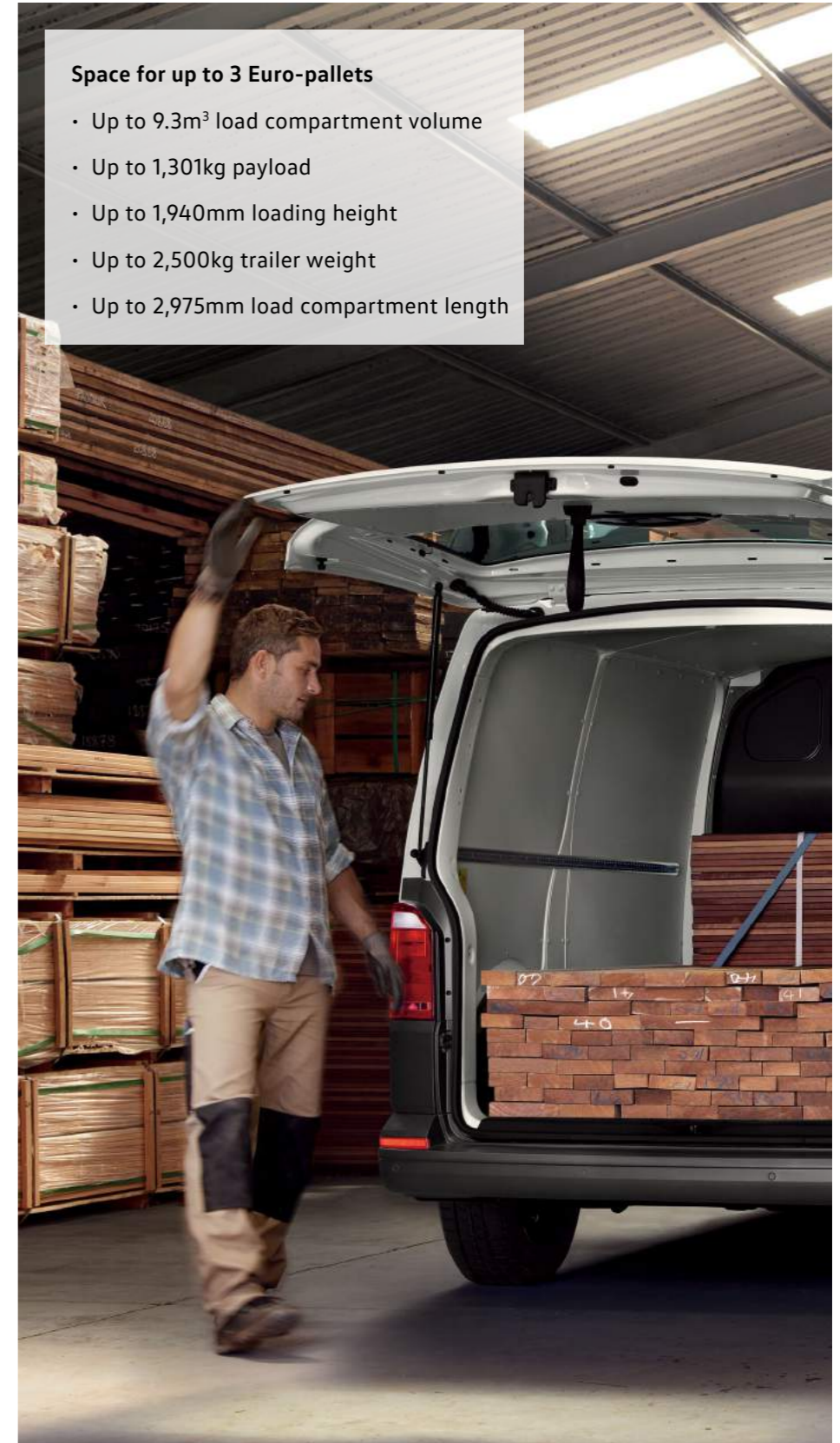

So which model do you need?

Choose your van.

Your van.

You probably already have an idea about what you need from your ideal van and what you'll need to carry. Likewise, you're sure to have an idea about what's the heaviest, tallest, widest or longest load you'll need to get into your vehicle. If you're a Fleet Manager, then you'll probably need a variety of options and more than one vehicle. Bearing these factors in mind, the information featured on these pages is designed to help as a quick guide to which vehicle may be the closest match to your own specific requirements.

Your trimline.

For added choice, there's a variety of trimlines available, each delivering its own distinct feel. From the robust Startline to the luxurious Highline, you're sure to find a vehicle and trimline combination that not only works hard, but also creates the right impression.

Your choice.

And remember, that's not all. Every Transporter is available with a wide range of options and accessories – all designed to further help tailor your vehicle to your own particular needs. So which model do you need?

How to select your van:

1. Think about the **maximum length and height** of your load. This will help you choose a wheelbase and roof height. If you need to carry more than two passengers, you'll need to consider choosing a Transporter kombi.
2. On the following page you'll see **payload¹** ranges. Think about the heaviest load you need to carry. This will help you choose what's suitable (for instance a T30).
3. From the choice available, decide which **trimline** is right for you.
4. Take a look at the separate Transporter price list to discover which **engines and options** are available for your chosen van.

¹ For further information about weights, please refer to the Technical information section.

Please note: The kombi's load dimensions vary slightly from the above panel van figures. For further information about dimensions, please refer to the Technical information section.

Short wheelbase low roof.



Load length²: 2,572mm
Load width: 1,700mm
Load height: 1,410mm

5.8m³
load area volume.

Long wheelbase low roof.



Load length²: 2,975mm
Load width: 1,700mm
Load height: 1,410mm

6.7m³
load area volume.

Long wheelbase high roof.



Load length²: 2,975mm
Load width: 1,700mm
Load height: 1,940mm

9.3m³
load area volume.

² Please note: load length is based on vehicles without a bulkhead.

Exterior dimensions.

2,477mm

High roof height.

1,990mm

Low roof height

5,304mm

Long wheelbase length

4,904mm

Short wheelbase length

Panel van.

		Startline	Trendline	Highline	Payload
Short wheelbase low roof	T28 (2,800kg)	●	●	●	802kg - 892kg
	T30 (3,000kg)	●	●	●	1,002kg - 1,092kg
	T32 (3,200kg)	●	●	●	1,043kg - 1,278kg
Long wheelbase low roof	T28 (2,800kg)	●	●	●	745kg - 835kg
	T30 (3,000kg)	●	●	●	945kg - 1,035kg
	T32 (3,200kg)	●	●	●	987kg - 1,221kg
Long wheelbase high roof	T28 (2,800kg)	●	●	●	745kg - 835kg
	T30 (3,000kg)	●	●	●	945kg - 1,035kg
	T32 (3,200kg)	●	●	●	987kg - 1,221kg

Kombi.

Short wheelbase low roof	T30 (3,000kg)	●	●	●	861kg - 1,018kg
	T32 (3,200kg)	●	●	●	966kg - 1,174kg
Long wheelbase low roof	T32 (3,200kg)	●	●	●	903kg - 1,141kg
Long wheelbase high roof	T32 (3,200kg)	●	●	●	903kg - 1,141kg

Delivering expectations. The Transporter panel van.

Starting from
£22,095†

Please click here for more details.

Designed to work, the Transporter panel van is available with a choice of three roof heights, two wheelbases and six engines. This level of choice and adaptability means you can tailor your van more precisely to the needs of your business. Standard cab seating consists of a single driver's seat with height, lumbar, reach and rake adjustment and a dual passenger seat. There's also the option of a single passenger seat. Access to the cargo area is through a single near-side sliding door and twin rear wing doors without windows, while a second, off-side, sliding door can also be specified. To restrain your cargo, the floor area features either six or eight load-lashing rings (depending on you choice of wheelbase), ensuring your load is secured as safely as possible.

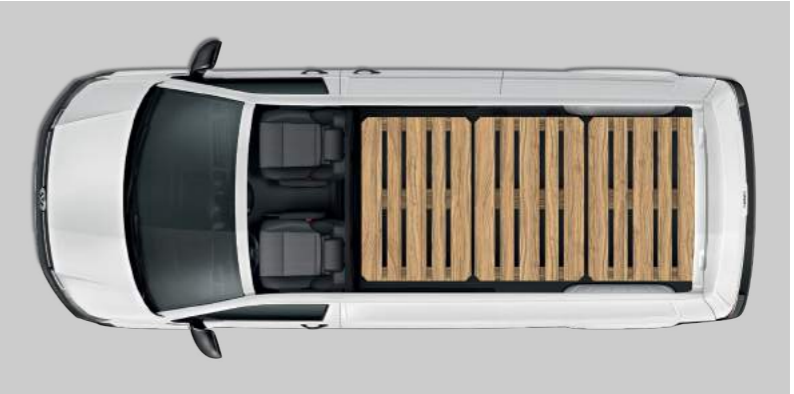

Long wheelbase with optional single passenger seat.



Volkswagen Commercial Vehicles may change RRPs at any time (this includes where there are government changes in regulation and/or legislation). There may be a delay to any RRP displaying correctly on our materials. Always obtain prices from your chosen authorised Van Centre.

† Basic RRP excluding VAT.

Working with you	Design	Interior	Assistance systems	4MOTION	Rear door & load space solutions	Choose your van	Transporter panel van	Business Pack	Transporter kombi	Startline	Trendline	Highline	Edition	Sportline	Paint, trim & upholstery	Wheels	Audio & comms	Technical information	Price list	Offers & finance	Service & warranties
------------------	--------	----------	--------------------	---------	----------------------------------	-----------------	-----------------------	---------------	-------------------	-----------	-----------	----------	---------	-----------	--------------------------	--------	---------------	-----------------------	------------	------------------	----------------------

Upgrade your new Transporter with the discounted Business Pack.

Startline panel van and kombi.

- Anti-theft alarm with interior monitoring in cab, backup horn and towing protection
- Climatic air conditioning system
- Rear parking sensors

Now you can drive away in an upgraded Volkswagen Transporter for less thanks to the Business Pack.

Available on the Transporter Startline models, the discounted pack features rear parking sensors, climatic air conditioning, an anti-theft alarm and towing protection for as little as £865 +VAT.

That's a saving of £490 for you and your business. So your Transporter can be kitted out with some of our most advanced and practical features without costing you the earth.

FOR ONLY
£865
 + VAT



Volkswagen Commercial Vehicles may change RRP's at any time (this includes where there are government changes in regulation and/or legislation). There may be a delay to any RRP displaying correctly on our materials. Always obtain prices from your chosen authorised Van Centre.

Perfect for cargo and crew alike.

The Transporter kombi.

Versatility is at the core of every Transporter kombi. With an identical choice of roof heights, wheelbases and engines to the panel van, the kombi features a single front passenger seat and adds to the panel van by offering removable rear seating for a further three passengers – all fitted with 3-point seatbelts and height-adjustable head restraints. Access to the rear passenger area is through a single near-side glazed sliding door, while at the rear there's a glazed tailgate with heated window and wash-wipe. Featuring a robust rubber floor covering throughout the cab and cargo area, as well as four load-lashing rings in the cargo area, the kombi's flexible interior can be transformed in seconds from a comfortable five or six-seater, into a spacious delivery van. It's the ideal choice when you need to combine load carrying with the ability to safely transport a crew of up to six (including the driver).

Starting from
£23,880†

Please click here for more details.



The Transporter kombi long wheelbase can seat up to five or six people, with ample storage space for luggage too.



Volkswagen Commercial Vehicles may change RRP's at any time (this includes where there are government changes in regulation and/or legislation). There may be a delay to any RRP displaying correctly on our materials. Always obtain prices from your chosen authorised Van Centre.

† Basic RRP excluding VAT.

Choose your trimline. Startline equipment.

Starting from **£22,095[†]** [Please click here for more details.](#)

Once you've found your ideal van – or indeed vans if you're a fleet customer, the next step is to choose your perfect trimline. Both the Transporter panel van and kombi have a choice of five levels **Startline, Trendline, Highline, Edition and Sportline** – each with their own particular strengths and all designed to create the right impression for your business.

Audio and communications

- Bluetooth® phone connectivity with trip computer and multi-function display plus.
- Composition Colour DAB+ radio system with 5" touch-screen, single MP3 compatible CD drive, SD card slot, AUX-IN socket and four speakers.
- USB connection in glove compartment or storage shelf.

Cab area.

- Austin cloth upholstery.
- Digital clock.
- Dimmable dashboard illumination.
- Door mirrors – electrically heated and adjustable.
- Driver's seat with height, lumbar, reach and rake adjustment.
- Dual passenger seat.
- Electric front windows.
- Folding grab handles on roof frame.
- Gear shift indicator.
- Interior light.
- Lockable glove compartment.
- Manually controlled heating system with dust and pollen filter and air recirculation.
- Rev counter.
- Rubber floor covering.
- Single passenger seat with reach and rake adjustment (kombi).
- 12V sockets x 2.

Cargo area.

- Half-height load side lining in hardboard (panel van).
- Full-height load side lining in hardboard (kombi).
- Full-height steel bulkhead (panel van).
- Interior entry step.
- Interior roof trim in painted hardboard (low roof only).
- Load-lashing rings (six for short wheelbase and eight for long wheelbase).
- Rear door interior release lever.
- Rubber floor covering (kombi).
- Manual near-side sliding door.
- Sliding windows in near-side sliding door and opposite window (kombi).
- Steel flooring (panel van).
- Three-seat bench in first row (kombi).
- Two door activated interior lights (three with optional high roof).

Exterior.

- Front and rear towing eyes.
- Galvanised steel body.
- Black door mirrors and handles.
- Black front and rear bumpers.
- Heat insulating glass.
- Tailgate with heated window and wash-wipe (kombi).
- Unglazed rear wing doors with 180° door opening (panel van).

Safety and security.

- Anti-lock Braking System (ABS).
- Automatic Post-Collision Braking System.
- Brake Assist.
- Driver Alert System.
- Driver and passenger front airbags (with passenger deactivation).
- Electronic Brakeforce Distribution (EBD).
- Electronic Differential Lock (EDL).
- Electronic Stabilisation Programme (ESP).
- Front Assist with City Emergency Braking System.
- Height-adjustable head restraints.
- Height and rake adjustable steering column.
- Hill Hold Assist.
- Remote central locking with interior locking and two remote folding keys.
- Seatbelt warning when not engaged.
- Thatcham Category 2 approved immobiliser.
- Traction Control System (TCS).
- Tyre pressure monitoring (kombi).

Wheels and tyres.

- 16" steel wheels. 16 x 6.5J with 205/65 R16 low rolling resistance tyres.
- Black wheel centre caps.
- Full size steel spare wheel.
- Tool kit and jack.

Efficiency technology.

- Low rolling resistance tyres.
- Regenerative braking.
- Start/Stop.

Upgrade your new Transporter Startline with a Business Pack and save £490.†

† Saving against the cost of purchasing individual items.

- Anti-theft alarm with interior monitoring in cab, back-up horn and towing protection
- Climatic air conditioning system
- Rear parking sensors

[Find out more](#)

FOR ONLY **£865** + VAT



Volkswagen Commercial Vehicles may change RRP's at any time (this includes where there are government changes in regulation and/or legislation). There may be a delay to any RRP displaying correctly on our materials. Always obtain prices from your chosen authorised Van Centre.

† Basic RRP excluding VAT.

Equipment in addition to Startline. Trendline equipment.

Starting from **£23,205[†]**

[Please click here for more details.](#)

The **Trendline** equipment builds upon the strengths of the Startline by offering a wide range of stylish, practical and technological items. By selecting the most popular options available and combining them into one handy pack, the Trendline offers amazing value when compared to ordering each item individually.

Cab area.

Armrests for driver's seat.

Armrests for front passenger seat (kombi).

Comfort pack – including foldable grab handles on 'A' pillars, waste bin for door pockets in cab, twin sun visors with vanity mirrors, two-tone horn, dimmable dashboard illumination and additional noise suppression measures.

Cruise control.

Simora cloth upholstery.

Exterior.

Body-coloured bumpers, door mirrors and handles.

Rear parking sensors.

Wheels and tyres.

Stylish full wheel trims.



01



02



03

01 Full wheel trims. An eye-catching and realistic alloy wheel-effect design.

02 Body-coloured bumpers, door mirrors and handles. Increased elegance for style-conscious businesses.

03 Rear parking sensors. For added safety when reversing.

Unladen weight, payload, fuel consumption and CO₂ emissions may be influenced by trimline, factory options and Van Centre fitted accessories.

Volkswagen Commercial Vehicles may change RRP's at any time (this includes where there are government changes in regulation and/or legislation). There may be a delay to any RRP displaying correctly on our materials. Always obtain prices from your chosen authorised Van Centre.

[†] Basic RRP excluding VAT.

Equipment in addition to Trendline. Highline equipment.

Starting from **£24,970†** [Please click here for more details.](#)

The luxurious **Highline** adds to the Trendline's already impressive specification and offers the perfect balance of comfort and style in a hard-working vehicle. Choose a Highline and you'll have a van that's designed to help get your business noticed.

Cab area.

Automatically dimming rear-view mirror with rain sensor.

Automatic driving light control.

Climatic air conditioning.

Heated windscreen.

Leather multi-function steering wheel, gearknob and gaiter.

Exterior.

Automatic headlight activation with daytime running lights, leaving home and manual coming home function.

Front fog lights with cornering lights.

Safety and security.

Thatcham Category 1 approved alarm and immobiliser with tow-away, perimeter and interior cab protection.

Wheels and tyres.

16" Clayton alloy wheels with 205/65 R16 low rolling resistance tyres (T28, T30 102PS and 150PS engines).

17" Devonport alloy wheels with 215/65 R17 low rolling resistance tyres (T32 and/or 204PS engine).



01



02



03



04



01 Climatic air conditioning.
Delivers a temperature controlled environment.

02 Leather multi-function steering wheel, gearknob and gaiter.
Adds a touch of class to your Transporter's interior.

03 16" Clayton alloy wheels.
Standard on T28, T30 102PS and 150PS engines.

04 17" Devonport alloy wheels.
Standard on T32 and/or 204PS engine.

Unladen weight, payload, fuel consumption and CO₂ emissions may be influenced by trimline, factory options and Van Centre fitted accessories.

Volkswagen Commercial Vehicles may change RRP's at any time (this includes where there are government changes in regulation and/or legislation). There may be a delay to any RRP displaying correctly on our materials. Always obtain prices from your chosen authorised Van Centre.

† Basic RRP excluding VAT.

Style as well as practicality. The Transporter Edition.

Starting from
£30,620†

Please click here for more details.



Take the practicality of a T30 panel van or the versatility of a T30 kombi and add to that striking exterior styling highlights and an impressive array of standard equipment, and you'll have a van ready for any eventuality. The stunning new **Edition** builds on the Highline's impressive specification and combines it with a striking high-gloss black roof and wing mirrors and unique 'EDITION' decals that accentuate the bodylines. The exterior styling is finished off with 17 or 18 inch alloys depending on which engine you opt for, LED headlights with LED daytime running lights and privacy glass. Assistance is provided by power latching for the passenger side sliding door and Discover Media satellite navigation system, while front and rear parking sensors with rear-view camera make light work of parking or reversing.

Decorative decals may show signs of wear and tear or ageing, in particular when subjected to direct sunlight, after a period of 1 to 3 years or even within 1 year in very hot climates. If the decorative decals remain on the vehicle for an extended period of time, visual differences may appear between the area protected by the decal and the paint finish that is not covered by decal.

Volkswagen Commercial Vehicles may change RRP's at any time (this includes where there are government changes in regulation and/or legislation). There may be a delay to any RRP displaying correctly on our materials. Always obtain prices from your chosen authorised Van Centre.

† Basic RRP excluding VAT.

Working with you	Design	Interior	Assistance systems	4MOTION	Rear door & load space solutions	Choose your van	Transporter panel van	Business Pack	Transporter kombi	Startline	Trendline	Highline	Edition	Sportline	Paint, trim & upholstery	Wheels	Audio & comms	Technical information	Price list	Offers & finance	Service & warranties
------------------	--------	----------	--------------------	---------	----------------------------------	-----------------	-----------------------	---------------	-------------------	-----------	-----------	----------	----------------	-----------	--------------------------	--------	---------------	-----------------------	------------	------------------	----------------------

Equipment in addition to Highline. Transporter Edition equipment.

Audio and communications.

Discover Media satellite navigation system including DAB+ radio, 6.33" touch-screen, AUX-IN, SD card slot, USB port, Bluetooth® phone connectivity, MP3 compatible CD player and four speakers.

App-Connect.

Driver assistance.

LED headlights with LED daytime running lights.

Front and rear parking sensors with rear-view camera.

Headlight washer system with heated front washer nozzles and washer fluid level indicator.

Exterior.

Dark tinted LED rear combination lights.

High-gloss black roof.

High-gloss black wing mirrors.

Tailgate with heated window and wash-wipe (kombi).

Tailgate without window (panel van).

Unique 'EDITION' decals.

Body and chassis.

Power latching for passenger side sliding door.

Power folding wing mirrors.

Wheels and tyres.

17" x 7J Cascavel alloy wheels with black diamond-turned surface and 235/55 R17 103H low rolling resistance tyres (150PS engine).

18" x 8J Springfield alloy wheels with black surface and 255/45 R18 103H low rolling resistance tyres (204PS engine).

Tyre mobility kit in lieu of spare wheel; 12V compressor and tyre sealant.

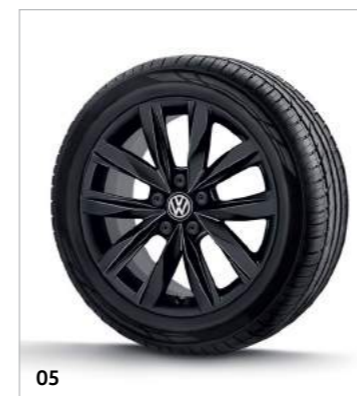

01 Discover Media satellite navigation system. Includes DAB+ radio, App-Connect and a 6.33" colour touch-screen display for radio and navigation functions.

02 Unique 'EDITION' decals feature on the side and rear panels.

03 High-gloss black roof and wing mirrors enhance the Edition's dynamic look from top to bottom.

04 17" Cascavel alloy wheels with black diamond-turned surface (150PS engine).

05 18" Springfield alloy wheels with black surface (204PS engine).

Unladen weight, payload, fuel consumption and CO₂ emissions may be influenced by trimline, factory options and Van Centre fitted accessories.

A sporting icon. The Transporter Sportline*.

The sixth generation Transporter Sportline has improved with age and is fast becoming an icon in the world of commercial vehicles. Available as a short or long wheelbase panel van or versatile kombi, the powerful 204PS BiTDI Sportline guarantees swift progress with the 7-speed dual clutch direct shift gearbox (DSG). And when it comes to hard work, the Sportline delivers with a generous 3.2 tonne gross vehicle weight and a sporty and luxurious interior that's designed to ease you through your working day and make every journey a pleasure. In fact, with the kind of performance and specification levels to grace any top-of-the-range vehicle, the iconic Transporter Sportline offers a commercial vehicle experience that's second-to-none.



Starting from **£39,685†** [Please click here for more details.](#)

Volkswagen Commercial Vehicles may change RRP's at any time (this includes where there are government changes in regulation and/or legislation). There may be a delay to any RRP displaying correctly on our materials. Always obtain prices from your chosen authorised Van Centre.

* This vehicle is currently unavailable to factory order. Please contact your local authorised Van Centre for stock availability. † Basic RRP excluding VAT.

Working with you	Design	Interior	Assistance systems	4MOTION	Rear door & load space solutions	Choose your van	Transporter panel van	Business Pack	Transporter kombi	Startline	Trendline	Highline	Edition	Sportline	Paint, trim & upholstery	Wheels	Audio & comms	Technical information	Price list	Offers & finance	Service & warranties
------------------	--------	----------	--------------------	---------	----------------------------------	-----------------	-----------------------	---------------	-------------------	-----------	-----------	----------	---------	------------------	--------------------------	--------	---------------	-----------------------	------------	------------------	----------------------

Equipment in addition to Edition. Transporter Sportline equipment*.

The top-of-the-range **Sportline** features all of the qualities found across the Transporter range, but with an enhanced specification that's as comprehensive as it is sporty. It's the ultimate commercial vehicle for businesses and individuals who want to make a statement.

Audio and communications.

App Connect and Volkswagen Media Control.

Cab area.

Fitted floor mats with Sportline logo.

Carpet flooring in cab (kombi only).

Leather quilted seats – two-tone Black and Red with embossed Sportline logo.

Single driver's seat and dual front passenger bench (panel van).

Single driver's seat and single front passenger's seat with armrests (kombi).

Comfort dash with wide centre console and bottle compartment including decorative insert in anthracite and removal of front 12V socket (kombi only).

2-seater bench on the driver's side and individual seat with easy-entry feature on the passenger's side in 2nd row of seats (kombi).

Wheels and tyres.

18" Sportline alloy wheels low rolling resistance tyres (available in a choice of finishes).

Exterior.

Carbon fibre door mirror covers.

Manual side sliding door, driver's side with power latching

Front bumper spoiler.

Lowered suspension.

Side bars with puddle lights.

Sportline badging.

Rear roof spoiler.

* This vehicle is currently unavailable to factory order. Please contact your local authorised Van Centre for stock availability.

Unladen weight, payload, fuel consumption and CO₂ emissions may be influenced by trimline, factory options and Van Centre fitted accessories.



- 01 Discover Media satellite navigation system.** Includes DAB+ radio and 6.33" touch-screen for radio and navigation functions.
- 02 Door mirrors.** Carbon fibre covers.
- 03 Rear roof spoiler.** Delivers the perfect sporty finishing touch.
- 04 Front bumper spoiler.** Includes front fog lights and cornering lighting.
- 05 18" Sportline alloy wheels.**

Paint.



Candy White¹ Solid paint



Pure Grey² Solid paint



Cherry Red Solid paint



Grape Yellow^{2,3,4} Solid paint



Bright Orange² Solid paint



Summer Blue Solid paint



Deep Ocean² Solid paint



Reflex Silver^{1,4} Metallic paint



Indium Grey⁴ Metallic paint



Mojave Beige⁴ Metallic paint



Chestnut Brown⁴ Metallic paint



Bamboo Garden Green⁴ Metallic paint



Acapulco Blue⁴ Metallic paint



Starlight Blue⁴ Metallic paint



Oryx White^{4,5} Pearl effect paint



Deep Black^{1,4} Pearl effect paint

1 Reflex Silver and Candy White with a black painted roof and Deep Black are available on Sportline at extra cost.

2 Pure Grey, Grape Yellow, Bright Orange and Deep Ocean are only available on Startline.

3 Grape Yellow is available on Edition.

4 Available at extra cost.

5 Oryx White is not available on Sportline.

Please note: Not all paint and upholstery combinations can be ordered together and in some instances certain combinations may incur extra cost. Not all paint finishes may be available for every trimline. Please check details and availability with your Volkswagen Van Centre at the time of ordering. Screen representations do not allow exact reproduction of paint, upholstery and trim colours.

Trim & upholstery.

Formulated to help withstand all that work can throw at it, the Transporter's paint, trim and upholstery are designed to stand the test of time. As you'd expect from any Volkswagen, exterior paints offer a smooth and tough finish, while the interior upholstery is made from high-quality materials that are both robust and easy to clean.

Interior trim.



Moonrock Grey

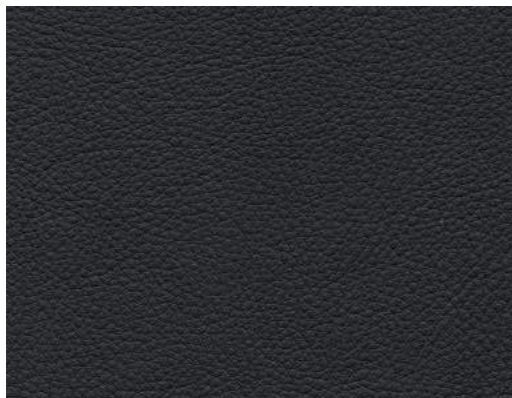

Titanium Black

Seat upholstery.

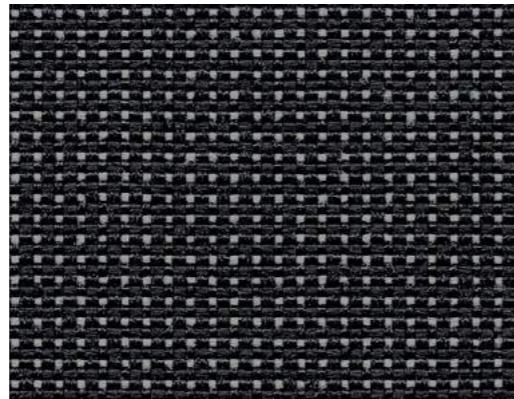

Austin¹
Titanium Black cloth **SL**

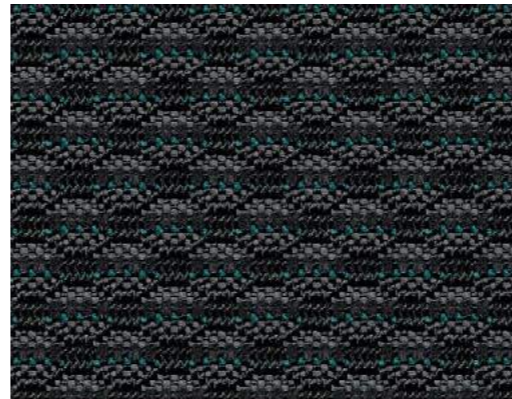

Simora²
Titanium Black cloth **TL HL E**

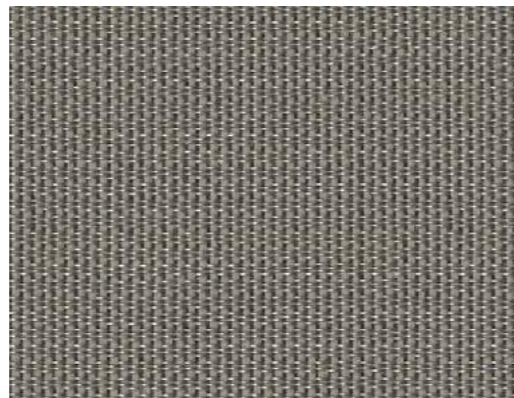

Marathon^{2,3}
Moonrock Robust cloth
SL TL HL E



Leatherette²
Titanium Black 'Mesh' Leatherette
SL TL HL E

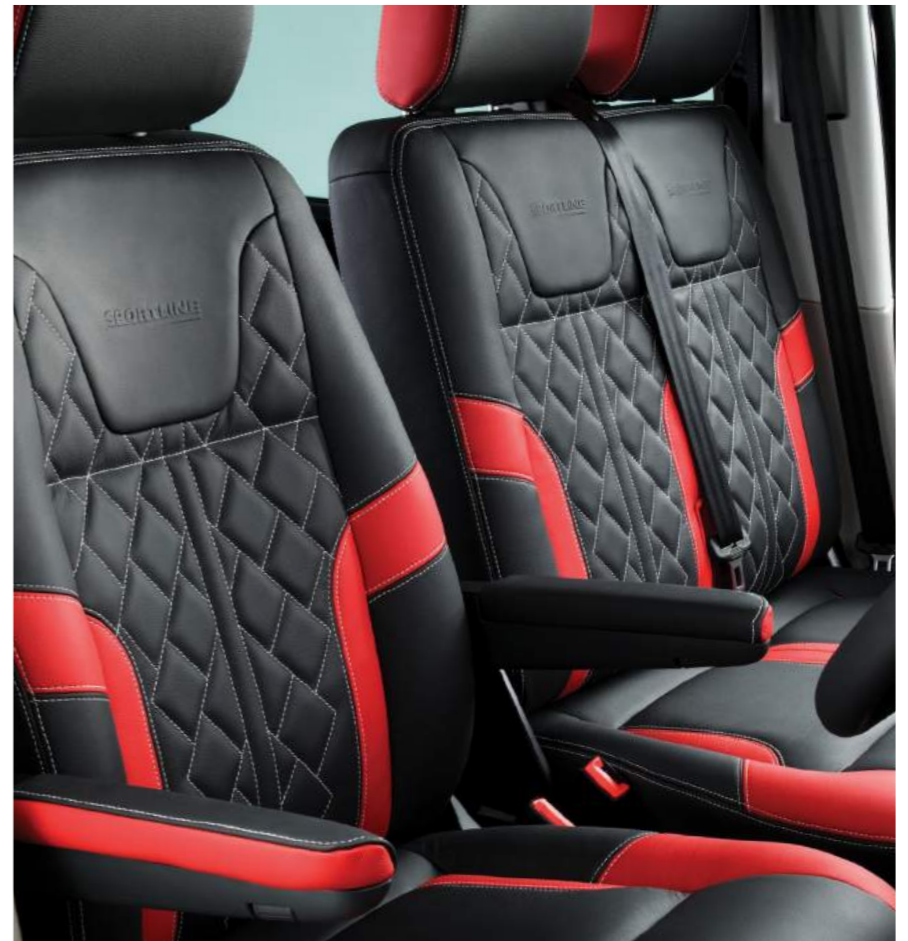

Sportline quilted leather
Two-tone Red and Black
SP

Standard Optional

SL | Startline TL | Trendline HL | Highline E | Edition SP | Sportline

1 Also available in Moonrock. 2 Available at extra cost. 3 Only available for the cab. **Please note:** Not all paint and upholstery combinations can be ordered together and in some instances certain combinations may incur extra cost. Not all paint finishes may be available for every trimline. Please check details and availability with your Volkswagen Van Centre at the time of ordering. Screen representations do not allow exact reproduction of paint colours.

Wheels.

01 16" Steel wheel. 16 x 6.5J with 215/65 R16 or 205/65 R16 tyres. Standard on Startline.

02 16" Full wheel trim. 16 x 6.5J with 215/65 R16 or 205/65 R16 tyres. Standard on Trendline.

03 16" Clayton. 16 x 6.5J alloy wheels with 215/65 R16 or 205/65 R16 tyres. Standard on Highline T28, T30 102PS or 150PS. Optional on Startline and Trendline.

04 17" Cascavel. 17 x 7J alloy wheels, black diamond-turned surface with 235/55 R17 103H low rolling resistance tyres. Standard on Edition T30 150PS.

05 17" Devonport. 17 x 7J alloy wheels with 235/55 R17 or 215/65 R17 tyres. Standard on Highline T32 and/or 204PS.

06 18" Springfield. 18 x 8J alloy wheels, black surface with 255/45 R18 103H low rolling resistance tyres. Standard on Edition T30 204PS.



Audio & communications.



01 Composition Colour DAB+ radio system.
Fitted as standard, the Composition Colour DAB+ radio system features a 5" TFT touch-screen colour display, USB port, Bluetooth®, SD card slot, AUX-IN interface, MP3 and WMA compatible CD drive, 4 x 20 watt output with four speakers and a dual tuner with PhaseDiversity for optimum radio reception.

02 Composition Media DAB+ radio system.
The optional Composition Media DAB+ radio system features an increased touch-screen size of 6.33" with proximity sensor, USB port, Bluetooth®, SD card slot, AUX-IN interface, MP3 and WMA compatible CD drive, 4 x 20 watt output with four speakers and a dual tuner with PhaseDiversity for optimum radio reception. App-Connect is available as an option for this system.

03 Discover Media satellite navigation system.
The optional Discover Media satellite navigation system builds on the strengths of the Composition Media DAB+ radio system by adding satellite navigation and a second integrated SD card slot compatible for map data. The system includes free updates for the pre-installed European maps through Volkswagen MapCare. App-Connect is available as an option for this system.

04 App-Connect.¹ Available as an option with the Composition Media DAB+ radio system or Discover Media navigation system. App-Connect allows you to operate special apps. The screen of your smartphone can be shown on the radio system's display.

¹ The 'App' control button on the optional Discover Media navigation system is only enabled when ordered in conjunction with the optional App-Connect system.

Mobile online services.

Optional App-Connect – Volkswagen apps.¹

Download special Volkswagen apps to your mobile or tablet, such as 'Shared Audio', 'Drive & Track', 'Call & Remind', 'My Guide' and 'Sound Journey' to make every journey more pleasant and interesting. The apps provide you with information about your driving behaviour, guide you to parking spaces in the vicinity, make detailed suggestions about exciting destinations – all taking into account the weather and traffic data.

Optional Car-Net Guide & Inform.²

Use Car-Net Guide & Inform to enhance your vehicle's optional Discover Media navigation system with online-based, up-to-date information services for greater convenience when travelling. For example, utilise real-time traffic information to avoid a sudden traffic jam, or refuel at the cheapest fuel station, or find a free parking space without the need for an infuriating search. Car-Net Guide & Inform helps you to reach your destination quickly and with the least amount of stress.



Online traffic information.

Save time and avoid stress with real-time traffic information, enabling you to avoid traffic jams by dynamically adapting your route.



Fuel stations.³

View the fuel stations with the cheapest fuel prices in your immediate vicinity. Your vehicle's fuel type is automatically identified.



Parking spaces.³

Save time and view available parking options, along with prices and opening hours.



Weather.

Stay up-to-date with the latest weather information while on the move.



Online special destination search.

Customised information about local services is sent directly to your touch-screen display.



News.

Subscribe to personalised news categories and use the news feeds to stay up-to-date.



Online destination import.

Conveniently plan your driving destinations from home using the customer portal and retrieve them using the navigation system.



My special destinations.

Use the customer portal to save your preferred destinations while at home and import these into your vehicle's navigation system.



Vehicle status report.

Retrieve the latest service information and error messages from your vehicle.



Car-Net registration in a few easy steps:

1. Create your personal account on the Car-Net website.
2. You will receive a registration code (PIN).
3. Enter your vehicle identification number (VIN).
4. Enter the PIN into your vehicle's navigation system.

¹ Available as an option, App-Connect is only available in conjunction with the Composition Media DAB+ radio system or the Discover Media satellite navigation system. App-Connect comprises MirrorLink™, CarPlay™ and Android Auto™. The availability of these technologies can vary depending on the country in question. Please note that App-Connect is not currently supported by all mobile telephones on the market. Volkswagen is working closely with major smartphone producers to promote broader compatibility for App-Connect.
² Available as an option, mobile online services (Car-Net) is only available in conjunction with the Discover Media satellite navigation system. You will also require a mobile device that is capable of acting as a mobile wireless hotspot. Car-Net services are only available with an existing mobile network contract or one to be agreed separately for this purpose between you and your mobile phone network provider and only within the respective mobile phone network coverage. Depending on your mobile phone tariff, receiving data from the internet may incur additional charges, particularly if you are using the phone abroad. Due to the amount of data needed when using Car-Net services, we strongly recommend signing-up to a data flat rate with your mobile phone provider. Use of Car-Net is governed in a separate agreement with Volkswagen AG online. After taking possession of the vehicle, you have 90 days in which to register the vehicle at www.volkswagen-commercial-vehicles-carnet.com. The availability of Car-Net services may vary depending on the country in question. These services are available for the duration of the contract term agreed and may be subject to changes in terms of content during the contract period. More detailed information on Car-Net is available at www.volkswagen-commercial-vehicles-carnet.com and from your Volkswagen Commercial Vehicles Van Centre. Contact your mobile network provider for information regarding your mobile network tariff.
³ Available at participating fuel stations and car parks.

Engine & gearbox data.

Engine specifications.	2.0TDI 102PS	2.0TDI 150PS	2.0BiTDI 204PS
Engine type	Diesel, transverse, water-cooled, in-line, variable turbine geometry turbocharger with intercooler	Diesel, transverse, water-cooled, in-line, variable turbine geometry turbocharger with intercooler	Diesel, transverse, water-cooled, in-line, bi-turbo with intercooler
Mixture preparation/injection method	Common-rail, direct injection	Common-rail, direct injection	Common-rail, direct injection
EU exhaust emission standard	EURO 6D Temp	EURO 6D Temp	EURO 6D Temp
Number of cylinders	4	4	4
Cubic capacity	1,968cc	1,968cc	1,968cc
Output, PS at rpm	102 at 3,000-3,750	150 at 3,250-3,750	204 at 4,000
Torque, max. Nm at rpm	250 at 1,500-2,750	340 at 1,500-3,000	450 at 1,400-2,400
Fuel tank capacity	70 litre	70 litre	70 litre
AdBlue® capacity	13 litre	13 litre	13 litre
Diesel Particulate Filter [DPF]	●	●	●
5-speed manual gearbox	●	-	-
6-speed manual gearbox	-	●	-
7-speed dual clutch gearbox [DSG]	-	○	●
Front-wheel drive	●	●	●
4MOTION all-wheel drive	-	○	○
Alternator	140A ¹	140A ¹	140A
Battery - manual	75Ah (420A)	75Ah (420A)	-
Battery - DSG	-	75Ah (420A)	75Ah (420A)

● Standard ○ Available - Not available ¹ Highline models feature a 180A alternator.

Panel van fuel consumption, performance and emissions.

Short wheelbase with low roof.

		Urban mpg (ltr/100km) ¹	Extra-Urban mpg (ltr/100km) ¹	Combined mpg (ltr/100km) ¹	Acceleration, secs 0 - 62mph	Top speed, mph ²	CO ₂ emissions, g/km ¹
Startline – Short wheelbase with low roof.							
T28	2.0TDI 102PS 5-speed manual	38.7 (7.3)	54.3 (5.2)	47.1 (6.0)	15.3	98	156
	2.0TDI 150PS 6-speed manual	38.7 (7.3)	52.3 (5.4)	46.3 (6.1)	11.1	113	159
T30	2.0TDI 102PS 5-speed manual	38.7 (7.3)	54.3 (5.2)	47.1 (6.0)	15.3	98	156
	2.0TDI 150PS 6-speed manual	38.7 (7.3)	52.3 (5.4)	46.3 (6.1)	11.1	113	159
	2.0TDI 150PS 7-speed DSG	42.2 (6.7)	51.4 (5.5)	47.1 (6.0)	11.2	112	156
T32	2.0TDI 102PS 5-speed manual	38.2 (7.4)	53.3 (5.3)	46.3 (6.1)	15.3	98	158
	2.0TDI 150PS 6-speed manual	38.2 (7.4)	51.4 (5.5)	45.6 (6.2)	11.1	113	161
	2.0TDI 150PS 7-speed DSG	41.5 (6.8)	49.6 (5.7)	46.3 (6.1)	11.2	112	158
	2.0TDI 150PS 4MOTION 6-speed manual	35.8 (7.9)	48.7 (5.8)	42.8 (6.6)	11.3	111	172

Trendline – Short wheelbase with low roof.

T28	2.0TDI 102PS 5-speed manual	38.7 (7.3)	54.3 (5.2)	47.1 (6.0)	15.3	98	156
	2.0TDI 150PS 6-speed manual	38.7 (7.3)	52.3 (5.4)	46.3 (6.1)	11.1	113	159
T30	2.0TDI 102PS 5-speed manual	38.7 (7.3)	54.3 (5.2)	47.1 (6.0)	15.3	98	156
	2.0TDI 150PS 6-speed manual	38.7 (7.3)	52.3 (5.4)	46.3 (6.1)	11.1	113	159
	2.0TDI 150PS 7-speed DSG	42.2 (6.7)	51.4 (5.5)	47.1 (6.0)	11.2	112	156
T32	2.0TDI 150PS 6-speed manual	38.2 (7.4)	50.4 (5.6)	44.8 (6.3)	11.1	113	164
	2.0TDI 150PS 7-speed DSG	41.5 (6.8)	49.6 (5.7)	46.3 (6.1)	11.2	112	158

		Urban mpg (ltr/100km) ¹	Extra-Urban mpg (ltr/100km) ¹	Combined mpg (ltr/100km) ¹	Acceleration, secs 0 - 62mph	Top speed, mph ²	CO ₂ emissions, g/km ¹
Highline – Short wheelbase with low roof.							
T28	2.0TDI 102PS 5-speed manual	38.7 (7.3)	54.3 (5.2)	47.1 (6.0)	15.3	98	156
	2.0TDI 150PS 6-speed manual	38.2 (7.4)	51.4 (5.5)	45.6 (6.2)	11.1	113	162
	2.0TDI 150PS 7-speed DSG	42.2 (6.7)	51.4 (5.5)	47.1 (6.0)	11.2	112	156
T30	2.0TDI 102PS 5-speed manual	38.7 (7.3)	54.3 (5.2)	47.1 (6.0)	15.3	98	156
	2.0TDI 150PS 6-speed manual	38.2 (7.4)	51.4 (5.5)	45.6 (6.2)	11.1	113	162
	2.0TDI 150PS 7-speed DSG	42.2 (6.7)	51.4 (5.5)	47.1 (6.0)	11.2	112	156
T32	2.0TDI 150PS 6-speed manual	38.2 (7.4)	50.4 (5.6)	44.8 (6.3)	11.1	113	164
	2.0TDI 150PS 7-speed DSG	41.5 (6.8)	49.6 (5.7)	46.3 (6.1)	11.2	112	158
	2.0TDI 150PS 4MOTION 6-speed manual	34.9 (8.1)	47.9 (5.9)	42.2 (6.7)	11.3	111	175
	2.0BiTDI 204PS 4MOTION 7-speed DSG	36.7 (7.7)	46.3 (6.1)	42.2 (6.7)	9.1	124	174

Edition – Short wheelbase with low roof.

T30	2.0TDI 150PS 6-speed manual	38.7 (7.3)	52.3 (5.4)	46.3 (6.1)	11.1	113	159
	2.0TDI 150PS 7-speed DSG	42.2 (6.7)	51.4 (5.5)	47.1 (6.0)	11.2	112	156

Sportline* – Short wheelbase with low roof.

T32	2.0BiTDI 204PS 7-speed DSG	39.2 (7.2)	49.6 (5.7)	45.6 (6.2)	8.9	126	163
-----	----------------------------	------------	------------	------------	-----	-----	-----

* This vehicle is currently unavailable to factory order. Please contact your local authorised Van Centre for stock availability.

1 We are currently changing over to the new vehicle testing regime known as the Worldwide Harmonised Light Vehicle Test Procedure (WLTP). This is being phased in for Light Commercial Vehicles (LCVs) and replaces the New European Driving Cycle (NEDC) test procedure for establishing the official fuel consumption and CO₂ emissions figures for new vehicles. WLTP applies to all vehicle manufacturers. If you order an LCV now, it is likely to have different official fuel consumption, CO₂ emissions data and specification to that shown in the configurator. For more information, please speak to your local authorised Van Centre. Comparisons may be unreliable.

Other factors including Gross Vehicle Weight, trimline, extra equipment, options and accessories (wheels, tyres, etc.) may change vehicle parameters such as the weight, rolling resistance of the tyres and the aerodynamics and thus influence the fuel consumption, CO₂ emissions and driving performance values.

2 Where the law permits.

Panel van fuel consumption, performance and emissions (continued).

Long wheelbase with low roof.

		Urban mpg (ltr/100km) ¹	Extra-Urban mpg (ltr/100km) ¹	Combined mpg (ltr/100km) ¹	Acceleration, secs 0 - 62mph	Top speed, mph ²	CO ₂ emissions, g/km ¹
Startline – Long wheelbase with low roof.							
T28	2.0TDI 102PS 5-speed manual	38.2 (7.4)	53.3 (5.3)	46.3 (6.1)	15.3	98	159
T30	2.0TDI 102PS 5-speed manual	38.2 (7.4)	53.3 (5.3)	46.3 (6.1)	15.3	98	159
	2.0TDI 150PS 6-speed manual	38.2 (7.4)	51.4 (5.5)	45.6 (6.2)	11.1	113	162
T32	2.0TDI 102PS 5-speed manual	37.7 (7.5)	52.3 (5.4)	45.6 (6.2)	15.3	98	161
	2.0TDI 150PS 6-speed manual	38.2 (7.4)	50.4 (5.6)	44.8 (6.3)	11.1	113	164
	2.0TDI 150PS 7-speed DSG	41.5 (6.8)	49.6 (5.7)	46.3 (6.1)	11.2	112	158
	2.0TDI 150PS 4MOTION 6-speed manual	34.9 (8.1)	47.9 (5.9)	42.2 (6.7)	11.3	111	175
Trendline – Long wheelbase with low roof.							
T28	2.0TDI 102PS 5-speed manual	38.2 (7.4)	53.3 (5.3)	46.3 (6.1)	15.3	98	159
	2.0TDI 150PS 6-speed manual	38.2 (7.4)	51.4 (5.5)	45.6 (6.2)	11.1	113	162
T30	2.0TDI 102PS 5-speed manual	38.2 (7.4)	53.3 (5.3)	46.3 (6.1)	15.3	98	159
	2.0TDI 150PS 6-speed manual	38.2 (7.4)	51.4 (5.5)	45.6 (6.2)	11.1	113	162
T32	2.0TDI 150PS 6-speed manual	38.2 (7.4)	50.4 (5.6)	44.8 (6.3)	11.1	113	164
	2.0TDI 150PS 4MOTION 6-speed manual	34.9 (8.1)	47.9 (5.9)	42.2 (6.7)	11.3	111	175

		Urban mpg (ltr/100km) ¹	Extra-Urban mpg (ltr/100km) ¹	Combined mpg (ltr/100km) ¹	Acceleration, secs 0 - 62mph	Top speed, mph ²	CO ₂ emissions, g/km ¹
Highline – Long wheelbase with low roof.							
T28	2.0TDI 150PS 6-speed manual	38.2 (7.4)	51.4 (5.5)	45.6 (6.2)	11.1	113	162
	2.0TDI 150PS 7-speed DSG	42.2 (6.7)	51.4 (5.5)	47.1 (6.0)	11.2	112	156
T30	2.0TDI 102PS 5-speed manual	38.2 (7.4)	53.3 (5.3)	46.3 (6.1)	15.3	98	159
	2.0TDI 150PS 6-speed manual	38.2 (7.4)	51.4 (5.5)	45.6 (6.2)	11.1	113	162
	2.0TDI 150PS 7-speed DSG	42.2 (6.7)	51.4 (5.5)	47.1 (6.0)	11.2	112	156
T32	2.0TDI 150PS 6-speed manual	38.2 (7.4)	50.4 (5.6)	44.8 (6.3)	11.1	113	164
	2.0TDI 150PS 7-speed DSG	40.4 (7.0)	48.7 (5.8)	45.6 (6.2)	11.2	112	163
	2.0TDI 150PS 4MOTION 6-speed manual	34.9 (8.1)	47.9 (5.9)	42.2 (6.7)	11.3	111	175
	2.0BitDI 204PS 4MOTION 7-speed DSG	36.2 (7.8)	45.6 (6.2)	41.5 (6.8)	9.1	124	177
Sportline* – Long wheelbase with low roof.							
T32	2.0BitDI 204PS 7-speed DSG	38.2 (7.4)	48.7 (5.8)	43.5 (6.5)	8.9	126	168

* This vehicle is currently unavailable to factory order. Please contact your local authorised Van Centre for stock availability.

¹ We are currently changing over to the new vehicle testing regime known as the Worldwide Harmonised Light Vehicle Test Procedure (WLTP). This is being phased in for Light Commercial Vehicles (LCVs) and replaces the New European Driving Cycle (NEDC) test procedure for establishing the official fuel consumption and CO₂ emissions figures for new vehicles. WLTP applies to all vehicle manufacturers. If you order an LCV now, it is likely to have different official fuel consumption, CO₂ emissions data and specification to that shown in the configurator. For more information, please speak to your local authorised Van Centre. Comparisons may be unreliable.

Other factors including Gross Vehicle Weight, trimline, extra equipment, options and accessories (wheels, tyres, etc.) may change vehicle parameters such as the weight, rolling resistance of the tyres and the aerodynamics and thus influence the fuel consumption, CO₂ emissions and driving performance values.

² Where the law permits.

Panel van fuel consumption, performance and emissions (continued).

Long wheelbase with high roof.

		Urban mpg (ltr/100km) ¹	Extra-Urban mpg (ltr/100km) ¹	Combined mpg (ltr/100km) ¹	Acceleration, secs 0 - 62mph	Top speed, mph ²	CO ₂ emissions, g/km ¹
Startline – Long wheelbase with high roof.							
T28	2.0TDI 102PS 5-speed manual	36.7 (7.7)	49.6 (5.7)	44.1 (6.4)	15.5	90	167
T30	2.0TDI 102PS 5-speed manual	36.7 (7.7)	49.6 (5.7)	44.1 (6.4)	15.5	90	167
	2.0TDI 150PS 6-speed manual	37.7 (7.5)	47.9 (5.9)	43.5 (6.5)	11.6	106	170
T32	2.0TDI 102PS 5-speed manual	36.7 (7.7)	49.6 (5.7)	43.5 (6.5)	15.5	90	169
	2.0TDI 150PS 6-speed manual	37.2 (7.6)	47.1 (6.0)	42.8 (6.6)	11.6	106	172
	2.0TDI 150PS 7-speed DSG	40.9 (6.9)	46.3 (6.1)	44.1 (6.4)	11.7	105	166
	2.0TDI 150PS 4MOTION 6-speed manual	34.9 (8.1)	44.8 (6.3)	40.9 (6.9)	11.7	105	181
Trendline – Long wheelbase with high roof.							
T28	2.0TDI 102PS 5-speed manual	36.7 (7.7)	49.6 (5.7)	44.1 (6.4)	15.5	90	167
	2.0TDI 150PS 6-speed manual	37.7 (7.5)	47.9 (5.9)	43.5 (6.5)	11.6	106	170
T30	2.0TDI 102PS 5-speed manual	36.7 (7.7)	49.6 (5.7)	44.1 (6.4)	15.5	90	167
	2.0TDI 150PS 6-speed manual	37.7 (7.5)	47.9 (5.9)	43.5 (6.5)	11.6	106	170
T32	2.0TDI 150PS 6-speed manual	37.2 (7.6)	47.1 (6.0)	42.8 (6.6)	11.6	106	172
	2.0TDI 150PS 4MOTION 6-speed manual	34.9 (8.1)	44.8 (6.3)	40.9 (6.9)	11.8	104	181

		Urban mpg (ltr/100km) ¹	Extra-Urban mpg (ltr/100km) ¹	Combined mpg (ltr/100km) ¹	Acceleration, secs 0 - 62mph	Top speed, mph ²	CO ₂ emissions, g/km ¹
Highline – Long wheelbase with high roof.							
T28	2.0TDI 150PS 6-speed manual	37.7 (7.5)	47.9 (5.9)	43.5 (6.5)	11.6	106	170
	2.0TDI 150PS 7-speed DSG	40.9 (6.9)	46.3 (6.1)	44.1 (6.4)	11.7	105	167
T30	2.0TDI 102PS 5-speed manual	36.7 (7.7)	49.6 (5.7)	44.1 (6.4)	15.5	90	167
	2.0TDI 150PS 6-speed manual	37.7 (7.5)	47.9 (5.9)	43.5 (6.5)	11.6	106	170
	2.0TDI 150PS 7-speed DSG	40.9 (6.9)	46.3 (6.1)	44.1 (6.4)	11.7	105	167
T32	2.0TDI 150PS 6-speed manual	36.7 (7.7)	46.3 (6.1)	42.2 (6.7)	11.6	106	175
	2.0TDI 150PS 7-speed DSG	40.4 (7.0)	45.6 (6.2)	43.5 (6.5)	11.7	105	169
	2.0TDI 150PS 4MOTION 6-speed manual	34.4 (8.2)	44.1 (6.4)	40.4 (7.0)	11.8	104	184
	2.0BiTDI 204PS 4MOTION 7-speed DSG	35.8 (7.9)	43.5 (6.5)	40.4 (7.0)	9.5	115	183

1 We are currently changing over to the new vehicle testing regime known as the Worldwide Harmonised Light Vehicle Test Procedure (WLTP). This is being phased in for Light Commercial Vehicles (LCVs) and replaces the New European Driving Cycle (NEDC) test procedure for establishing the official fuel consumption and CO₂ emissions figures for new vehicles. WLTP applies to all vehicle manufacturers. If you order an LCV now, it is likely to have different official fuel consumption, CO₂ emissions data and specification to that shown in the configurator. For more information, please speak to your local authorised Van Centre. Comparisons may be unreliable.

Other factors including Gross Vehicle Weight, trimline, extra equipment, options and accessories (wheels, tyres, etc.) may change vehicle parameters such as the weight, rolling resistance of the tyres and the aerodynamics and thus influence the fuel consumption, CO₂ emissions and driving performance values.

2 Where the law permits.

Kombi fuel consumption, performance and emissions.

Short wheelbase with low roof.

		Urban mpg (ltr/100km) ¹	Extra-Urban mpg (ltr/100km) ¹	Combined mpg (ltr/100km) ¹	Acceleration, secs 0 - 62mph	Top speed, mph ²	CO ₂ emissions, g/km ¹
Startline – Short wheelbase with low roof.							
T30	2.0TDI 102PS 5-speed manual	38.2 (7.4)	53.3 (5.3)	46.3 (6.1)	16.4	98	159
	2.0TDI 150PS 6-speed manual	38.2 (7.4)	51.4 (5.5)	45.6 (6.2)	11.9	113	162
T32	2.0TDI 150PS 6-speed manual	38.2 (7.4)	50.4 (5.6)	44.8 (6.3)	11.9	113	164
Trendline – Short wheelbase with low roof.							
T30	2.0TDI 102PS 5-speed manual	38.2 (7.4)	53.3 (5.3)	46.3 (6.1)	16.4	98	159
	2.0TDI 150PS 6-speed manual	38.2 (7.4)	51.4 (5.5)	45.6 (6.2)	11.9	113	162
T32	2.0TDI 150PS 6-speed manual	38.2 (7.4)	50.4 (5.6)	44.8 (6.3)	11.9	113	164

		Urban mpg (ltr/100km) ¹	Extra-Urban mpg (ltr/100km) ¹	Combined mpg (ltr/100km) ¹	Acceleration, secs 0 - 62mph	Top speed, mph ²	CO ₂ emissions, g/km ¹
Highline – Short wheelbase with low roof.							
T30	2.0TDI 102PS 5-speed manual	38.2 (7.4)	53.3 (5.3)	46.3 (6.1)	16.4	98	159
	2.0TDI 150PS 6-speed manual	38.2 (7.4)	51.4 (5.5)	45.6 (6.2)	11.9	113	162
	2.0TDI 150PS 7-speed DSG	42.2 (6.7)	51.4 (5.5)	47.1 (6.0)	12.0	112	156
	2.0BiTDI 204PS 4MOTION 7-speed DSG	36.2 (7.8)	46.3 (6.1)	42.2 (6.7)	9.6	124	175
T32	2.0TDI 102PS 5-speed manual	37.7 (7.5)	52.3 (5.4)	45.6 (6.2)	16.4	98	161
	2.0TDI 150PS 6-speed manual	36.7 (7.7)	49.6 (5.7)	43.5 (6.5)	11.9	113	169
	2.0TDI 150PS 7-speed DSG	40.4 (7.0)	48.7 (5.8)	45.6 (6.2)	12.0	112	163
	2.0TDI 150PS 4MOTION 6-speed manual	34.4 (8.2)	47.1 (6.0)	41.5 (6.8)	12.2	111	178
	2.0BiTDI 204PS 4MOTION 7-speed DSG	36.2 (7.8)	45.6 (6.2)	41.5 (6.8)	9.6	124	177
Edition – Short wheelbase with low roof.							
T30	2.0TDI 150PS 6-speed manual	38.2 (7.4)	51.4 (5.5)	45.6 (6.2)	11.9	113	162
	2.0TDI 150PS 7-speed DSG	42.2 (6.7)	51.4 (5.5)	47.1 (6.0)	12.0	112	156
Sportline* – Short wheelbase with low roof.							
T32	2.0BiTDI 204PS 7-speed DSG	38.2 (7.4)	48.7 (5.8)	43.5 (6.5)	9.1	126	168

* This vehicle is currently unavailable to factory order. Please contact your local authorised Van Centre for stock availability.

1 We are currently changing over to the new vehicle testing regime known as the Worldwide Harmonised Light Vehicle Test Procedure (WLTP). This is being phased in for Light Commercial Vehicles (LCVs) and replaces the New European Driving Cycle (NEDC) test procedure for establishing the official fuel consumption and CO₂ emissions figures for new vehicles. WLTP applies to all vehicle manufacturers. If you order an LCV now, it is likely to have different official fuel consumption, CO₂ emissions data and specification to that shown in the configurator. For more information, please speak to your local authorised Van Centre. Comparisons may be unreliable.

Other factors including Gross Vehicle Weight, trimline, extra equipment, options and accessories (wheels, tyres, etc.) may change vehicle parameters such as the weight, rolling resistance of the tyres and the aerodynamics and thus influence the fuel consumption, CO₂ emissions and driving performance values.

2 Where the law permits.

Kombi fuel consumption, performance and emissions (continued).

Long wheelbase with low roof.

		Urban mpg (ltr/100km) ¹	Extra-Urban mpg (ltr/100km) ¹	Combined mpg (ltr/100km) ¹	Acceleration, secs 0 - 62mph	Top speed, mph ²	CO ₂ emissions, g/km ¹
Startline – Long wheelbase with low roof.							
T32	2.0TDI 102PS 5-speed manual	37.7 (7.5)	52.3 (5.4)	45.6 (6.2)	16.4	98	161
	2.0TDI 150PS 6-speed manual	36.7 (7.7)	49.6 (5.7)	43.5 (6.5)	11.9	113	169
Trendline – Long wheelbase with low roof.							
T32	2.0TDI 102PS 5-speed manual	37.7 (7.5)	52.3 (5.4)	45.6 (6.2)	16.4	98	161
	2.0TDI 150PS 6-speed manual	36.7 (7.7)	49.6 (5.7)	43.5 (6.5)	11.9	113	169
Highline – Long wheelbase with low roof.							
T32	2.0TDI 150PS 6-speed manual	36.7 (7.7)	49.6 (5.7)	43.5 (6.5)	11.9	113	169
	2.0TDI 150PS 7-speed DSG	40.4 (7.0)	48.7 (5.8)	45.6 (6.2)	12.0	112	163
	2.0TDI 150PS 4MOTION 6-speed manual	34.4 (8.2)	47.1 (6.0)	41.5 (6.8)	12.2	111	178
	2.0BiTDI 204PS 4MOTION 7-speed DSG	36.2 (7.8)	45.6 (6.2)	41.5 (6.8)	9.6	124	177
Sportline* – Long wheelbase with low roof.							
T32	2.0BiTDI 204PS 7-speed DSG	37.2 (7.6)	47.1 (6.0)	42.8 (6.6)	9.1	126	171

Long wheelbase with high roof.

		Urban mpg (ltr/100km) ¹	Extra-Urban mpg (ltr/100km) ¹	Combined mpg (ltr/100km) ¹	Acceleration, secs 0 - 62mph	Top speed, mph ²	CO ₂ emissions, g/km ¹
Startline – Long wheelbase with high roof.							
T32	2.0TDI 102PS 5-speed manual	35.8 (7.9)	48.7 (5.8)	42.8 (6.6)	16.6	90	172
	2.0TDI 150PS 6-speed manual	36.7 (7.7)	46.3 (6.1)	42.2 (6.7)	12.2	106	175
Trendline – Long wheelbase with high roof.							
T32	2.0TDI 102PS 5-speed manual	35.8 (7.9)	48.7 (5.8)	42.8 (6.6)	16.6	90	172
	2.0TDI 150PS 6-speed manual	36.7 (7.7)	46.3 (6.1)	42.2 (6.7)	12.2	106	175
Highline – Long wheelbase with high roof.							
T32	2.0TDI 150PS 6-speed manual	36.7 (7.7)	46.3 (6.1)	42.2 (6.7)	12.2	106	175
	2.0TDI 150PS 7-speed DSG	39.8 (7.1)	44.8 (6.3)	42.8 (6.6)	12.3	105	172
	2.0TDI 150PS 4MOTION 6-speed manual	34.4 (8.2)	44.1 (6.4)	40.4 (7.0)	12.7	104	184
	2.0BiTDI 204PS 4MOTION 7-speed DSG	35.8 (7.9)	43.5 (6.5)	40.4 (7.0)	10.0	115	183

* This vehicle is currently unavailable to factory order. Please contact your local authorised Van Centre for stock availability.

1 We are currently changing over to the new vehicle testing regime known as the Worldwide Harmonised Light Vehicle Test Procedure (WLTP). This is being phased in for Light Commercial Vehicles (LCVs) and replaces the New European Driving Cycle (NEDC) test procedure for establishing the official fuel consumption and CO₂ emissions figures for new vehicles. WLTP applies to all vehicle manufacturers. If you order an LCV now, it is likely to have different official fuel consumption, CO₂ emissions data and specification to that shown in the configurator. For more information, please speak to your local authorised Van Centre. Comparisons may be unreliable.

Other factors including Gross Vehicle Weight, trimline, extra equipment, options and accessories (wheels, tyres, etc.) may change vehicle parameters such as the weight, rolling resistance of the tyres and the aerodynamics and thus influence the fuel consumption, CO₂ emissions and driving performance values.

2 Where the law permits.

Panel van weights.

Short wheelbase.

Model	Engine/transmission	Gross vehicle weight ¹ , kg	Axle load limit, front/rear, kg	Trailer weight braked 12%/unbraked, kg	Gross train weight, kg
T28	2.0TDI 102PS 5-speed manual	2,800	1,550 / 1,550	2,200 / 750	4,900
	2.0TDI 150PS 6-speed manual	2,800	1,600 / 1,550	2,500 / 750	5,200
	2.0TDI 150PS 7-speed DSG	2,800	1,600 / 1,550	2,500 / 750	5,300
T30	2.0TDI 102PS 5-speed manual	3,000	1,550 / 1,625	2,200 / 750	4,900
	2.0TDI 150PS 6-speed manual	3,000	1,600 / 1,625	2,500 / 750	5,200
	2.0TDI 150PS 7-speed DSG	3,000	1,600 / 1,625	2,500 / 750	5,300
T32	2.0TDI 102PS 5-speed manual	3,200	1,710 / 1,720	2,200 / 750	4,900
	2.0TDI 150PS 6-speed manual	3,200	1,710 / 1,720	2,500 / 750	5,200
	2.0TDI 150PS 7-speed DSG	3,200	1,710 / 1,720	2,500 / 750	5,300
	2.0TDI 150PS 4MOTION 6-speed manual	3,200	1,710 / 1,720	2,500 / 750	5,300
	2.0BITDI 204PS 7-speed DSG	3,200	1,710 / 1,720	2,500 / 750	5,300
	2.0BITDI 204PS 4MOTION 7-speed DSG	3,200	1,710 / 1,720	2,500 / 750	5,300

Startline.

Unladen weight ² , kg	Payload ³ , kg
1,908	892
1,938	862
-	-
1,908	1,092
1,938	1,062
1,959	1,041
1,922	1,278
1,952	1,248
1,973	1,227
2,074	1,126
-	-
-	-

Trendline.

Unladen weight ² , kg	Payload ³ , kg
1,919	881
1,949	851
-	-
1,919	1,081
1,949	1,051
1,970	1,030
-	-
1,963	1,237
1,984	1,216
-	-
-	-

Highline.

Unladen weight ² , kg	Payload ³ , kg
1,948	852
1,978	822
1,998	802
1,948	1,052
1,978	1,022
1,998	1,002
-	-
1,990	1,210
2,025	1,175
2,112	1,088
-	-
2,157	1,043

Edition.

Unladen weight ² , kg	Payload ³ , kg
-	-
-	-
-	-
-	-
1,940	1,060
1,961	1,039
-	-
-	-
-	-
-	-

Sportline*.

Unladen weight ² , kg	Payload ³ , kg
-	-
-	-
-	-
-	-
-	-
-	-
-	-
-	-
-	-
2,048	1,152
-	-

Long wheelbase.

Model	Engine/transmission	Gross vehicle weight ¹ , kg	Axle load limit, front/rear, kg	Trailer weight braked 12%/unbraked, kg	Gross train weight, kg
T28	2.0TDI 102PS 5-speed manual	2,800	1,550 / 1,550	2,200 / 750	4,900
	2.0TDI 150PS 6-speed manual	2,800	1,600 / 1,550	2,500 / 750	5,200
	2.0TDI 150PS 7-speed DSG	2,800	1,600 / 1,550	2,500 / 750	5,300
T30	2.0TDI 102PS 5-speed manual	3,000	1,550 / 1,625	2,200 / 750	4,900
	2.0TDI 150PS 6-speed manual	3,000	1,600 / 1,625	2,500 / 750	5,200
	2.0TDI 150PS 7-speed DSG	3,000	1,600 / 1,625	2,500 / 750	5,300
T32	2.0TDI 102PS 5-speed manual	3,200	1,710 / 1,720	2,200 / 750	4,900
	2.0TDI 150PS 6-speed manual	3,200	1,710 / 1,720	2,500 / 750	5,200
	2.0TDI 150PS 7-speed DSG	3,200	1,710 / 1,720	2,500 / 750	5,300
	2.0TDI 150PS 4MOTION 6-speed manual	3,200	1,710 / 1,720	2,500 / 750	5,300
	2.0BITDI 204PS 7-speed DSG	3,200	1,710 / 1,720	2,500 / 750	5,300
	2.0BITDI 204PS 4MOTION 7-speed DSG	3,200	1,710 / 1,720	2,500 / 750	5,300

Startline.

Unladen weight ² , kg	Payload ³ , kg
1,965	835
-	-
-	-
1,965	1,035
1,995	1,005
-	-
1,979	1,221
2,009	1,191
2,029	1,171
2,131	1,069
-	-
-	-

Trendline.

Unladen weight ² , kg	Payload ³ , kg
1,976	824
2,006	794
-	-
1,976	1,024
2,006	994
-	-
-	-
2,020	1,180
-	-
2,142	1,058
-	-
-	-

Highline.

Unladen weight ² , kg	Payload ³ , kg
-	-
2,034	766
2,055	745
2,004	996
2,034	966
2,055	945
-	-
2,047	1,153
2,081	1,119
2,169	1,031
-	-
2,213	987

Sportline*.

Unladen weight ² , kg	Payload ³ , kg
-	-
-	-
-	-
-	-
-	-
-	-
-	-
-	-
-	-
2,105	1,095
-	-

* This vehicle is currently unavailable to factory order. Please contact your local authorised Van Centre for stock availability.

1 We are currently changing over to the new vehicle testing regime known as the Worldwide Harmonised Light Vehicle Test Procedure (WLTP). This is being phased in for Light Commercial Vehicles (LCVs) and replaces the New European Driving Cycle (NEDC) test procedure for establishing the official fuel consumption and CO₂ emissions figures for new vehicles. WLTP applies to all vehicle manufacturers. If you order an LCV now, it is likely to have different official fuel consumption, CO₂ emissions data and specification to that shown in the configurator. For more information, please speak to your local authorised Van Centre. Comparisons may be unreliable. Other factors including Gross Vehicle Weight, trimline, extra equipment, options and accessories (wheels, tyres, etc.) may change vehicle parameters such as the weight, rolling resistance of the tyres and the aerodynamics and thus influence the fuel consumption, CO₂ emissions and driving performance values.

2 Unladen weight includes approximately 90% fuel load and 75kg for driver.

3 Payload = gross vehicle weight minus unladen weight. Quoted weights are for vehicles with standard specification. Unladen weight and payload may be influenced by trimline, factory options and Van Centre fitted accessories. Roof load limit: 100kg (with two roof carriers) or 150kg (with at least four roof carriers) for normal roof only. Trailer nose weight: 100kg.

Panel van dimensions.

Short wheelbase low roof.

Roof height	Low	
Wheelbase	3,000	
Load compartment	length	2,572
	width	1,700
	width between wheel arches	1,244
	height	1,410
	floor area	4.3m ²
	load volume	5.8m ³
Side sliding door	width	1,017
	height	1,282
Rear wing doors	width	1,473
	height	1,305
Tailgate	width	1,473
	height	1,299
Turning circle (wall to wall)	11.9m	

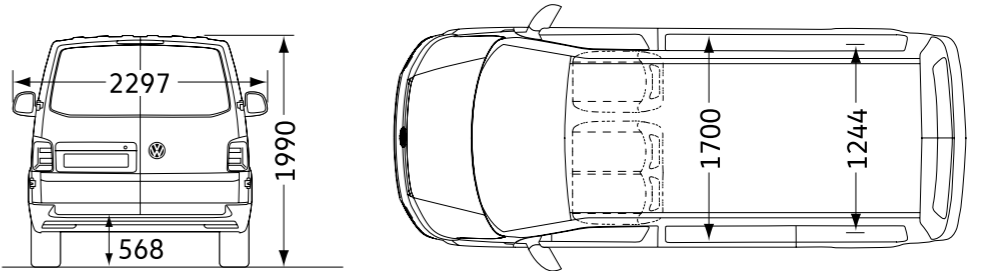
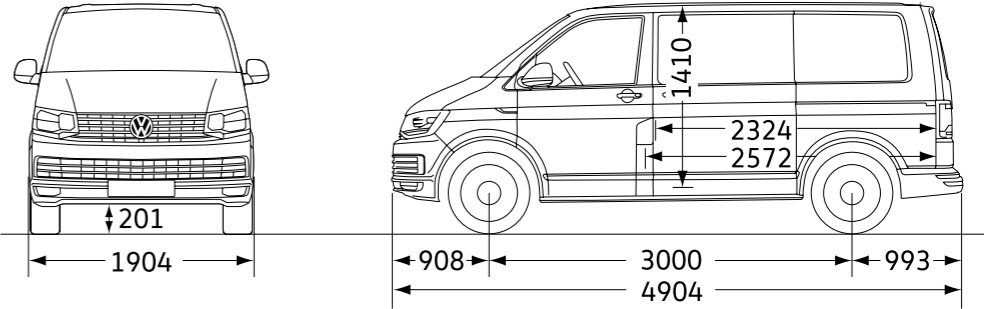

Long wheelbase low and high roof.

Roof height	Low	High¹
Wheelbase	3,400	3,400
Load compartment	length	2,975
	width	1,700
	width between wheel arches	1,244
	height	1,410
	floor area	5.0m ²
	load volume	6.7m ³
Side sliding door	width	1,017
	height	1,282
Optional high side sliding door	width	-
	height	-
Rear wing doors	width	1,473
	height	1,305
Tailgate	width	1,473
	height	1,299
Turning circle (wall to wall)	13.2m	13.2m

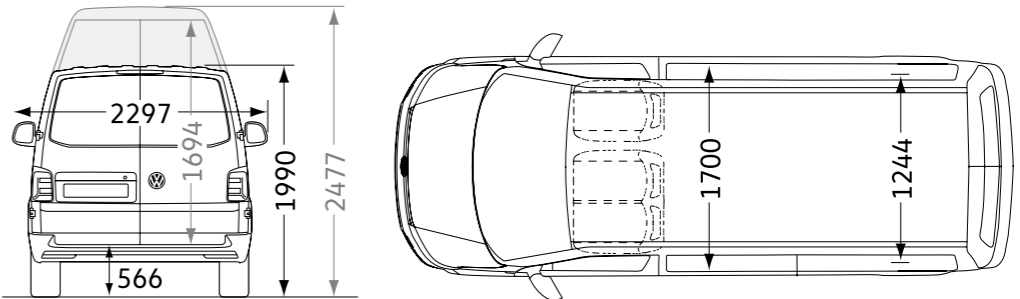
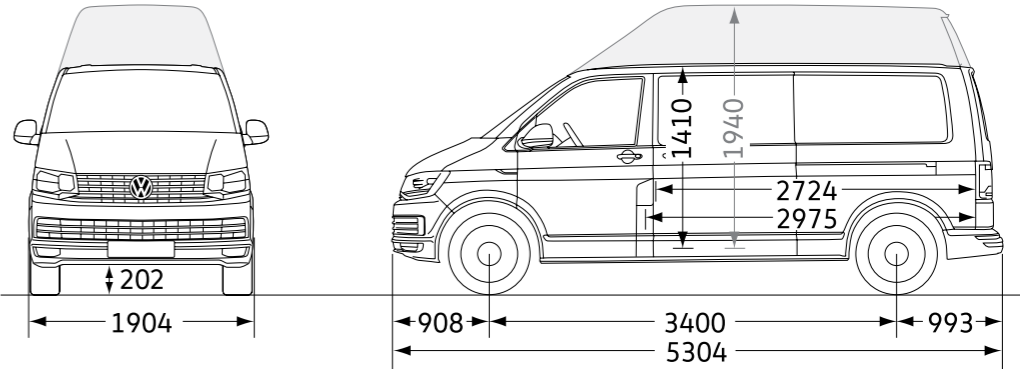

¹ Indicates optional high roof.

Please note: Vehicle drawings are not to scale. All dimensions in millimetres (mm), unless otherwise stated. The height measurements listed may vary by ± 50mm depending on model and equipment fitted.

Kombi dimensions.

Short wheelbase low roof.

Roof height		Low
Wheelbase		3,000
Load compartment	length	2,572
	length behind rear seats	1,600
	width	1,627
	width between wheel arches	1,244
	height	1,397
	floor area	4.3m ²
	load volume	5.8m ³
Side sliding door	width	1,017
	height	1,264
Rear wing doors	width	1,473
	height	1,305
Tailgate	width	1,473
	height	1,290
Turning circle (wall to wall)		11.9m

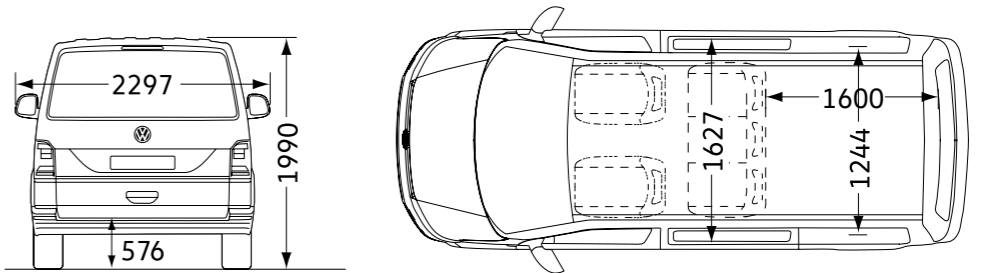
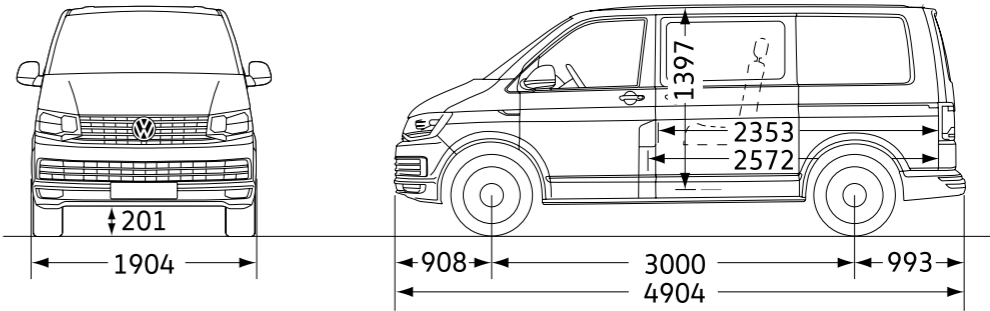

Long wheelbase low and high roof.

Roof height		Low	High¹
Wheelbase		3,400	3,400
Load compartment	length	2,938	2,938
	length behind rear seats	1,967	1,967
	width	1,627	1,627
	width between wheel arches	1,244	1,244
	height	1,394	1,924
	floor area	5.0m ²	5.0m ²
	load volume	6.7m ³	9.3m ³
Side sliding door	width	1,017	1,017
	height	1,264	1,264
Optional high side sliding door	width	-	1,017
	height	-	1,717
Rear wing doors	width	1,473	1,473
	height	1,305	1,694
Tailgate	width	1,473	-
	height	1,290	-
Turning circle (wall to wall)		13.2m	13.2m

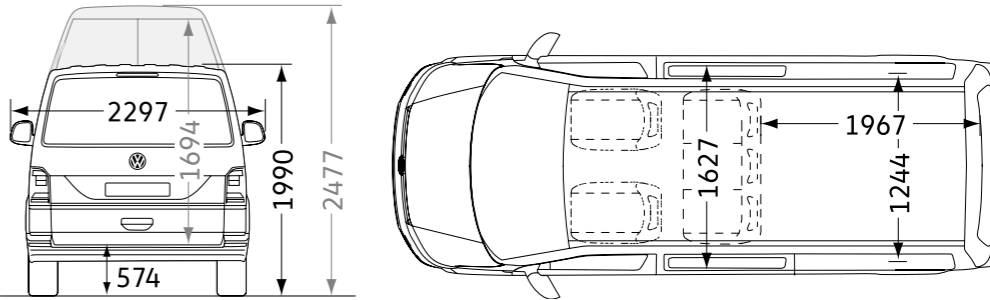
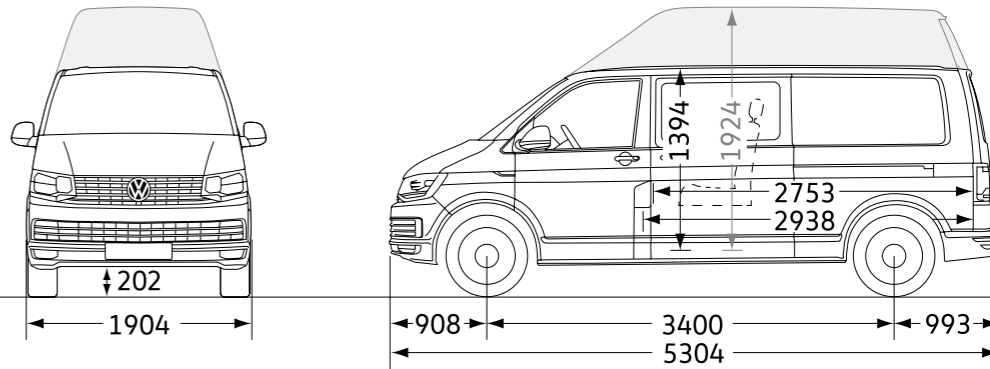

¹ Indicates optional high roof.

Please note: Vehicle drawings are not to scale. All dimensions in millimetres (mm), unless otherwise stated. The height measurements listed may vary by ± 50mm depending on model and equipment fitted.

Price list.



Upgrade your new Transporter Startline with a Business Pack and save £490.*

* Saving against the cost of purchasing individual items.

- Anti-theft alarm with interior monitoring in cab, back-up horn and towing protection
- Climatic air conditioning system
- Rear parking sensors

[Find out more](#)

FOR ONLY
£865
+ VAT



*Manufacturer's on the road (OTR) package.

Delivery to Van Centre	£620.00
Number plates	£20.00
VAT	£128.00
First registration fee	£55.00
Vehicle excise duty (VED) 1st year	£260.00
Basic OTR price (exc. VAT)	£955.00
Total OTR price (inc. VAT)	£1,083.00

Volkswagen Commercial Vehicles may change RRP's at any time (this includes where there are government changes in regulation and/or legislation). There may be a delay to any RRP displaying correctly on our materials. Always obtain prices from your chosen authorised Van Centre.

Model prices – Panel van short wheelbase.

Trimline	Model	Engine/transmission	Basic exc. VAT	Total inc. VAT	Total RRP inc. OTR* exc. VAT	Total RRP inc. OTR* inc. VAT
Startline	T28	2.0TDI 102PS 5-speed manual	£22,095.00	£26,514.00	£23,050.00	£27,597.00
		2.0TDI 150PS 6-speed manual	£24,245.00	£29,094.00	£25,200.00	£30,177.00
	T30	2.0TDI 102PS 5-speed manual	£22,550.00	£27,060.00	£23,505.00	£28,143.00
		2.0TDI 150PS 6-speed manual	£24,700.00	£29,640.00	£25,655.00	£30,723.00
		2.0TDI 150PS 7-speed DSG	£26,490.00	£31,788.00	£27,445.00	£32,871.00
	T32	2.0TDI 102PS 5-speed manual	£23,005.00	£27,606.00	£23,960.00	£28,689.00
		2.0TDI 150PS 6-speed manual	£25,155.00	£30,186.00	£26,110.00	£31,269.00
		2.0TDI 150PS 7-speed DSG	£26,945.00	£32,334.00	£27,900.00	£33,417.00
		2.0TDI 150PS 4MOTION 6-speed manual	£27,690.00	£33,228.00	£28,645.00	£34,311.00
	Trendline	T28	2.0TDI 102PS 5-speed manual	£23,205.00	£27,846.00	£24,160.00
2.0TDI 150PS 6-speed manual			£25,355.00	£30,426.00	£26,310.00	£31,509.00
T30		2.0TDI 102PS 5-speed manual	£23,660.00	£28,392.00	£24,615.00	£29,475.00
		2.0TDI 150PS 6-speed manual	£25,810.00	£30,972.00	£26,765.00	£32,055.00
		2.0TDI 150PS 7-speed DSG	£27,600.00	£33,120.00	£28,555.00	£34,203.00
T32		2.0TDI 150PS 6-speed manual	£26,265.00	£31,518.00	£27,220.00	£32,601.00
		2.0TDI 150PS 7-speed DSG	£28,055.00	£33,666.00	£29,010.00	£34,749.00

* Please click here for more details on manufacturer's on the road (OTR) package.

Volkswagen Commercial Vehicles may change RRP's at any time (this includes where there are government changes in regulation and/or legislation). There may be a delay to any RRP displaying correctly on our materials. Always obtain prices from your chosen authorised Van Centre.

Model prices – Panel van short wheelbase (continued).

Trimline	Model	Engine/transmission	Basic exc. VAT	Total inc. VAT	Total RRP inc. OTR* exc. VAT	Total RRP inc. OTR* inc. VAT
Highline	T28	2.0TDI 102PS 5-speed manual	£24,970.00	£29,964.00	£25,925.00	£31,047.00
		2.0TDI 150PS 6-speed manual	£27,120.00	£32,544.00	£28,075.00	£33,627.00
		2.0TDI 150PS 7-speed DSG	£28,910.00	£34,692.00	£29,865.00	£35,775.00
	T30	2.0TDI 102PS 5-speed manual	£25,425.00	£30,510.00	£26,380.00	£31,593.00
		2.0TDI 150PS 6-speed manual	£27,575.00	£33,090.00	£28,530.00	£34,173.00
		2.0TDI 150PS 7-speed DSG	£29,365.00	£35,238.00	£30,320.00	£36,321.00
	T32	2.0TDI 150PS 6-speed manual	£28,415.00	£34,098.00	£29,370.00	£35,181.00
		2.0TDI 150PS 7-speed DSG	£30,205.00	£36,246.00	£31,160.00	£37,329.00
		2.0TDI 150PS 4MOTION 6-speed manual	£30,950.00	£37,140.00	£31,905.00	£38,223.00
2.0BiTDI 204PS 4MOTION 7-speed DSG		£35,005.00	£42,006.00	£35,960.00	£43,089.00	
Edition	T30	2.0TDI 150PS 6-speed manual	£30,620.00	£36,744.00	£31,575.00	£37,827.00
		2.0TDI 150PS 7-speed DSG	£32,410.00	£38,892.00	£33,365.00	£39,975.00
Sportline†	T32	2.0BiTDI 204PS 7-speed DSG†	£39,685.00	£47,622.00	£40,640.00	£48,705.00

* Please click here for more details on manufacturer's on the road (OTR) package.

† This vehicle is currently unavailable to factory order. Please contact your local authorised Van Centre for stock availability.

Volkswagen Commercial Vehicles may change RRP's at any time (this includes where there are government changes in regulation and/or legislation). There may be a delay to any RRP displaying correctly on our materials. Always obtain prices from your chosen authorised Van Centre.

Model prices – Panel van long wheelbase.

Trimline	Model	Engine/transmission	Basic exc. VAT	Total inc. VAT	Total RRP inc. OTR* exc. VAT	Total RRP inc. OTR* inc. VAT
Startline	T28	2.0TDI 102PS 5-speed manual	£22,885.00	£27,462.00	£23,840.00	£28,545.00
	T30	2.0TDI 102PS 5-speed manual	£23,340.00	£28,008.00	£24,295.00	£29,091.00
		2.0TDI 150PS 6-speed manual	£25,490.00	£30,588.00	£26,445.00	£31,671.00
	T32	2.0TDI 102PS 5-speed manual	£23,795.00	£28,554.00	£24,750.00	£29,637.00
		2.0TDI 150PS 6-speed manual	£25,945.00	£31,134.00	£26,900.00	£32,217.00
		2.0TDI 150PS 7-speed DSG	£27,735.00	£33,282.00	£28,690.00	£34,365.00
		2.0TDI 150PS 4MOTION 6-speed manual	£28,480.00	£34,176.00	£29,435.00	£35,259.00
Trendline	T28	2.0TDI 102PS 5-speed manual	£23,995.00	£28,794.00	£24,950.00	£29,877.00
		2.0TDI 150PS 6-speed manual	£26,145.00	£31,374.00	£27,100.00	£32,457.00
	T30	2.0TDI 102PS 5-speed manual	£24,450.00	£29,340.00	£25,405.00	£30,423.00
		2.0TDI 150PS 6-speed manual	£26,600.00	£31,920.00	£27,555.00	£33,003.00
	T32	2.0TDI 150PS 6-speed manual	£27,055.00	£32,466.00	£28,010.00	£33,549.00
		2.0TDI 150PS 4MOTION 6-speed manual	£29,590.00	£35,508.00	£30,545.00	£36,591.00

* Please click here for more details on manufacturer's on the road (OTR) package.

Volkswagen Commercial Vehicles may change RRP's at any time (this includes where there are government changes in regulation and/or legislation). There may be a delay to any RRP displaying correctly on our materials. Always obtain prices from your chosen authorised Van Centre.

Model prices – Panel van long wheelbase (continued).

Trimline	Model	Engine/transmission	Basic exc. VAT	Total inc. VAT	Total RRP inc. OTR* exc. VAT	Total RRP inc. OTR* inc. VAT
Highline	T28	2.0TDI 150PS 6-speed manual	£27,910.00	£33,492.00	£28,865.00	£34,575.00
		2.0TDI 150PS 7-speed DSG	£29,700.00	£35,640.00	£30,655.00	£36,723.00
	T30	2.0TDI 102PS 5-speed manual	£26,215.00	£31,458.00	£27,170.00	£32,541.00
		2.0TDI 150PS 6-speed manual	£28,365.00	£34,038.00	£29,320.00	£35,121.00
		2.0TDI 150PS 7-speed DSG	£30,155.00	£36,186.00	£31,110.00	£37,269.00
	T32	2.0TDI 150PS 6-speed manual	£29,205.00	£35,046.00	£30,160.00	£36,129.00
		2.0TDI 150PS 7-speed DSG	£30,995.00	£37,194.00	£31,950.00	£38,277.00
		2.0TDI 150PS 4MOTION 6-speed manual	£31,740.00	£38,088.00	£32,695.00	£39,171.00
		2.0BiTDI 204PS 4MOTION 7-speed DSG	£35,795.00	£42,954.00	£36,750.00	£44,037.00
	Sportline†	T32	2.0BiTDI 204PS 7-speed DSG†	£40,475.00	£48,570.00	£41,430.00

* Please click here for more details on manufacturer's on the road (OTR) package.

† This vehicle is currently unavailable to factory order. Please contact your local authorised Van Centre for stock availability.

Volkswagen Commercial Vehicles may change RRP's at any time (this includes where there are government changes in regulation and/or legislation). There may be a delay to any RRP displaying correctly on our materials. Always obtain prices from your chosen authorised Van Centre.

Model prices – Kombi short wheelbase.

Trimline	Model	Engine/transmission	Basic exc. VAT	Total inc. VAT	Total RRP inc. OTR* exc. VAT	Total RRP inc. OTR* inc. VAT
Startline	T30	2.0TDI 102PS 5-speed manual	£23,880.00	£28,656.00	£24,835.00	£29,739.00
		2.0TDI 150PS 6-speed manual	£26,030.00	£31,236.00	£26,985.00	£32,319.00
	T32	2.0TDI 150PS 6-speed manual	£26,485.00	£31,782.00	£27,440.00	£32,865.00
Trendline	T30	2.0TDI 102PS 5-speed manual	£25,285.00	£30,342.00	£26,240.00	£31,425.00
		2.0TDI 150PS 6-speed manual	£27,435.00	£32,922.00	£28,390.00	£34,005.00
	T32	2.0TDI 150PS 6-speed manual	£27,890.00	£33,468.00	£28,845.00	£34,551.00
Highline	T30	2.0TDI 102PS 5-speed manual	£27,170.00	£32,604.00	£28,125.00	£33,687.00
		2.0TDI 150PS 6-speed manual	£29,320.00	£35,184.00	£30,275.00	£36,267.00
		2.0TDI 150PS 7-speed DSG	£31,110.00	£37,332.00	£32,065.00	£38,415.00
		2.0BiTDI 204PS 4MOTION 7-speed DSG	£36,190.00	£43,428.00	£37,145.00	£44,511.00
	T32	2.0TDI 102PS 5-speed manual	£27,905.00	£33,486.00	£28,860.00	£34,569.00
		2.0TDI 150PS 6-speed manual	£30,055.00	£36,066.00	£31,010.00	£37,149.00
		2.0TDI 150PS 7-speed DSG	£31,845.00	£38,214.00	£32,800.00	£39,297.00
		2.0TDI 150PS 4MOTION 6-speed manual	£32,590.00	£39,108.00	£33,545.00	£40,191.00
		2.0BiTDI 204PS 4MOTION 7-speed DSG	£36,645.00	£43,974.00	£37,600.00	£45,057.00
Edition	T30	2.0TDI 150PS 6-speed manual	£32,410.00	£38,892.00	£33,365.00	£39,975.00
		2.0TDI 150PS 7-speed DSG	£34,200.00	£41,040.00	£35,155.00	£42,123.00
Sportline†	T32	2.0BiTDI 204PS 7-speed DSG†	£43,370.00	£52,044.00	£44,325.00	£53,127.00

* Please click here for more details on manufacturer's on the road (OTR) package.

† This vehicle is currently unavailable to factory order. Please contact your local authorised Van Centre for stock availability.

Volkswagen Commercial Vehicles may change RRP's at any time (this includes where there are government changes in regulation and/or legislation). There may be a delay to any RRP displaying correctly on our materials. Always obtain prices from your chosen authorised Van Centre.

Model prices – Kombi long wheelbase.

Trimline	Model	Engine/transmission	Basic exc. VAT	Total inc. VAT	Total RRP inc. OTR* exc. VAT	Total RRP inc. OTR* inc. VAT
Startline	T32	2.0TDI 102PS 5-speed manual	£25,125.00	£30,150.00	£26,080.00	£31,233.00
		2.0TDI 150PS 6-speed manual	£27,275.00	£32,730.00	£28,230.00	£33,813.00
Trendline	T32	2.0TDI 102PS 5-speed manual	£26,530.00	£31,836.00	£27,485.00	£32,919.00
		2.0TDI 150PS 6-speed manual	£28,680.00	£34,416.00	£29,635.00	£35,499.00
Highline	T32	2.0TDI 150PS 6-speed manual	£30,845.00	£37,014.00	£31,800.00	£38,097.00
		2.0TDI 150PS 7-speed DSG	£32,635.00	£39,162.00	£33,590.00	£40,245.00
		2.0TDI 150PS 4MOTION 6-speed manual	£33,380.00	£40,056.00	£34,335.00	£41,139.00
		2.0BitDI 204PS 4MOTION 7-speed DSG	£37,435.00	£44,922.00	£38,390.00	£46,005.00
Sportline†	T32	2.0BitDI 204PS 7-speed DSG†	£44,160.00	£52,992.00	£45,115.00	£54,075.00

* Please click here for more details on manufacturer's on the road (OTR) package.

† This vehicle is currently unavailable to factory order. Please contact your local authorised Van Centre for stock availability.

Volkswagen Commercial Vehicles may change RRP's at any time (this includes where there are government changes in regulation and/or legislation). There may be a delay to any RRP displaying correctly on our materials. Always obtain prices from your chosen authorised Van Centre.

Options – Panel van and kombi.

Paint.	PR code.		Startline.		Trendline.		Highline.		Sportline.	
			Basic exc. VAT	Total RRP inc. VAT	Basic exc. VAT	Total RRP inc. VAT	Basic exc. VAT	Total RRP inc. VAT	Basic exc. VAT	Total RRP inc. VAT
Solid. Bright Orange (E3E3) ¹ , Candy White (B4B4), Cherry Red (4B4B), Deep Ocean ¹ (OPOP), Pure Grey ¹ (J2J2), Summer Blue ¹ (E2E2).	As shown	PV/K	○	○	○	○	○	○	-	-
Solid. Grape Yellow (1C1C).	As shown	PV/K	£215.00	£258.00	-	-	-	-	-	-
Metallic. Acapulco Blue (2W2W), Bamboo Garden Green (3T3T), Chestnut Brown (H4H4), Indium Grey (X3X3), Mojave Beige (1B1B), Reflex Silver ² (8E8E), Starlight Blue (3S3S).	As shown	PV/K	£590.00	£708.00	£590.00	£708.00	£590.00	£708.00	£590.00	£708.00
Pearl effect. Deep Black ² (2T2T).	As shown	PV/K	£590.00	£708.00	£590.00	£708.00	£590.00	£708.00	£590.00	£708.00
Mother-of-Pearl. Oryx White (OROR).	As shown	PV/K	£995.00	£1,194.00	£995.00	£1,194.00	£995.00	£1,194.00	-	-
Special paint. Candy White with black contrast roof ² .	As shown	PV/K	-	-	-	-	-	-	£1,090.00	£1,308.00

Upholstery.

Seat trim covers in Austin fabric. Seats: Moonrock Grey – Titanium Black/Dashboard upper: Titanium Black/Lower: Moonrock Grey/Flooring: Black. Seats: Titanium Black/Dashboard upper: Titanium Black/Lower: Moonrock Grey/Flooring: Black.	N1L	PV/K	●	●	-	-	-	-	-	-
Seat trim covers in Leatherette. Seats: Titanium Black/Dashboard upper: Titanium Black/Lower: Moonrock Grey/Flooring: Black.	N2Q	PV/K	£60.00	£72.00	£60.00	£72.00	£60.00	£72.00	-	-
Seat trim covers in Marathon Robust fabric in cab, Leatherette for passenger compartment. Seats: Moonrock Grey – Titanium Black/Dashboard upper: Titanium Black/Lower: Moonrock Grey/Flooring: Black.	NOR	PV/K	£120.00	£144.00	£120.00	£144.00	£120.00	£144.00	-	-
Seat trim covers in Simora fabric. Seats: Titanium Black/Dashboard upper: Titanium Black/Lower: Moonrock Grey/Flooring: Black.	N1Z	PV/K	-	-	●	●	●	●	-	-
Sportline leather. Seats: Embossed black and red leather. Dashboard upper: Titanium Black/Lower: Moonrock Grey/Flooring: Black.		PV/K	-	-	-	-	-	-	●	●

● Standard – Not available ○ At no extra cost Where additional equipment is required by chosen options, additional equipment will be charged at the prices shown.

1 Bright Orange, Deep Ocean, Pure Grey and Summer Blue are only available on Startline. 2 Reflex Silver metallic, Deep Black pearl effect and Candy White with black contrast roof special paints are available on Sportline models.

PV Panel van K Kombi

Volkswagen Commercial Vehicles may change RRP's at any time (this includes where there are government changes in regulation and/or legislation).

There may be a delay to any RRP displaying correctly on our materials. Always obtain prices from your chosen authorised Van Centre.

Options – Panel van and kombi (continued).

Seating.	PR code.		Startline.		Trendline.		Highline.		Sportline.	
			Basic exc. VAT	Total RRP inc. VAT	Basic exc. VAT	Total RRP inc. VAT	Basic exc. VAT	Total RRP inc. VAT	Basic exc. VAT	Total RRP inc. VAT
2-seater bench on the driver side and individual seat with easy-entry feature on the passenger side in 2nd row of seats.	3UF	K	£125.00	£150.00	£125.00	£150.00	£125.00	£150.00	●	●
Armrest for driver seat.	4S3	PV	£85.00	£102.00	●	●	●	●	●	●
Dual passenger seat in cab.	3TJ	PV	●	●	●	●	●	●	●	●
		K	£190.00	£228.00	£170.00	£204.00	£170.00	£204.00	-	-
Dual passenger seat in cab with integrated storage compartment.	3TS	PV	£105.00	£126.00	£105.00	£126.00	£105.00	£126.00	-	-
		K	£275.00	£330.00	£260.00	£312.00	£260.00	£312.00	-	-
Heated driver and front passenger seats. Separately controllable. Only in combination with either Climatic cab A/C, Climatic cab A/C with manual passenger heating, Climatic cab and passenger A/C (semi-automatic) with manual passenger compartment heating system at additional cost.	4A3	PV/K	£275.00	£330.00	£275.00	£330.00	£275.00	£330.00	£275.00	£330.00
Height-adjustment (manual) and lumbar support (manual) for driver and single front passenger seats. Only in combination with single front passenger seat.	7P4/3L3	PV	£100.00	£120.00	£100.00	£120.00	£100.00	£120.00	-	-
		K	£100.00	£120.00	●	●	●	●	●	●
Single front passenger seat.	3TH	PV	○	○	○	○	○	○	○	○
		K	●	●	●	●	●	●	●	●
Swivel seat. Driver and front passenger seat with armrest for driver and passenger, not height-adjustable. On Trendline and Highline panel van models this option will also remove the standard bulkhead.	3SD/3TD	PV	£105.00	£126.00	£105.00	£126.00	£105.00	£126.00	-	-
		K	£400.00	£480.00	£250.00	£300.00	£250.00	£300.00	-	-

● Standard – Not available ○ At no extra cost Where additional equipment is required by chosen options, additional equipment will be charged at the prices shown.

PV Panel van K Kombi

Volkswagen Commercial Vehicles may change RRP's at any time (this includes where there are government changes in regulation and/or legislation). There may be a delay to any RRP displaying correctly on our materials. Always obtain prices from your chosen authorised Van Centre.

Options – Panel van and kombi (continued).

Wheels and tyres.	PR code.		Startline.		Trendline.		Highline.		Sportline.	
			Basic exc. VAT	Total RRP inc. VAT	Basic exc. VAT	Total RRP inc. VAT	Basic exc. VAT	Total RRP inc. VAT	Basic exc. VAT	Total RRP inc. VAT
16" Clayton alloy wheels. 6.5J x 16. 4 alloys. Not available on T32 Gross vehicle weight vehicles or 204PS.	Z3E	PV/K	£690.00	£828.00	£585.00	£702.00	●	●	-	-
17" Devonport alloy wheels. 7J x 17. 4 alloys. Not available on Startline or Trendline T32 Gross vehicle weight vehicles. Tyre size: 235/55 R17 103H. Optimised rolling resistance.	Z3F/Q32	Highline 204PS and/or T32	-	-	-	-	●	●	-	-
18" Sportline alloy wheels. Choice of Black, Silver or Anthracite.		PV/K	-	-	-	-	-	-	●	●
All-weather tyres. Please contact your local Van Centre for availability on specific models.		PV/K	From £130.00	From £156.00	From £130.00	From £156.00	From £130.00	From £156.00	-	-
Wheel and tyre accessories.										
Tyre mobility kit in lieu of spare wheel. Includes 12V compressor and tyre sealant.	1G8	PV/K	○	○	○	○	○	○	●	●
Audio and communications.										
App-Connect. Only in combination with Composition Media DAB+ radio, or Discover Media navigation system at an additional cost.	9WT	PV/K	£145.00	£174.00	£145.00	£174.00	£145.00	£174.00	-	-
Bluetooth® hands-free set.	9ZX	PV/K	●	●	●	●	●	●	●	●
Composition Colour DAB+ radio with 5" touch-screen.	ZI4	PV/K	●	●	●	●	●	●	-	-
Composition Media DAB+ radio with 6.33" touch-screen.	ZI6	PV/K	£380.00	£456.00	£380.00	£456.00	£380.00	£456.00	-	-
Discover Media navigation system.	ZI7/ Z99/7RE	PV/K	£960.00	£1,152.00	£960.00	£1,152.00	£960.00	£1,152.00	●	●
Voice control. Only in combination with Composition Media radio or Discover Media Navigation system at an additional cost.	QH1	PV/K	£165.00	£198.00	£165.00	£198.00	£165.00	£198.00	£165.00	£198.00
Volkswagen Media Control and App-Connect. Only in combination with Discover Media Navigation system at an additional cost.	9WX	PV/K	£190.00	£228.00	£190.00	£228.00	£190.00	£228.00	●	●

● Standard – Not available ○ At no extra cost Where additional equipment is required by chosen options, additional equipment will be charged at the prices shown.

PV Panel van K Kombi

Volkswagen Commercial Vehicles may change RRP's at any time (this includes where there are government changes in regulation and/or legislation). There may be a delay to any RRP displaying correctly on our materials. Always obtain prices from your chosen authorised Van Centre.

Options – Panel van and kombi (continued).

Comfort and convenience.	PR Code.		Startline.		Trendline.		Highline.		Sportline.	
			Basic exc. VAT	Total RRP inc. VAT	Basic exc. VAT	Total RRP inc. VAT	Basic exc. VAT	Total RRP inc. VAT	Basic exc. VAT	Total RRP inc. VAT
Dashboard console with 1-DIN slot and positions for additional switches. Replaces standard tray.	5FD	PV	£60.00	£72.00	£60.00	£72.00	£60.00	£72.00	£60.00	£72.00
Headlight washer system and heated washer nozzles (windscreen) with washer fluid level indicator.	8X1	PV/K	£225.00	£270.00	£225.00	£270.00	£225.00	£270.00	●	●
Driver assistance.										
Adaptive Cruise Control (ACC) including Front Assist with City Emergency Braking System (Max speed 99mph where law permits). Only in combination with leather multi-function steering wheel.	PAD	PV/K	£475.00	£570.00	£345.00	£414.00	£345.00	£414.00	£345.00	£414.00
Cruise control.	8T2	PV/K	£130.00	£156.00	●	●	●	●	●	●
High Beam Assist.	8G1	PV/K	£335.00	£402.00	£125.00	£150.00	£125.00	£150.00	£125.00	£150.00
Leather multi-function steering wheel and gearknob with radio and telephone controls.	ZE7	PV/K	£320.00	£384.00	£320.00	£384.00	●	●	●	●
Parking sensors, rear. Acoustic warning signal for obstacles in the rear. See Business Pack offer.	7X1	PV/K	£245.00	£294.00	●	●	●	●	-	-
Parking sensors, front and rear.	7X2	PV/K	£425.00	£510.00	£295.00	£354.00	£295.00	£354.00	-	-
Parking sensors, front and rear with rear-view camera. On Panel van only in combination with a tailgate.	7X8	PV/K	£595.00	£714.00	£465.00	£558.00	£465.00	£558.00	●	●
Side Scan with cruise control. Only in combination with Lights & Vision pack, folding wing mirrors and tailgate (standard on kombi), at an additional cost. SWB only.	Z1Y	PV/K	£505.00	£606.00	£400.00	£480.00	£400.00	£480.00	-	-

● Standard – Not available ○ At no extra cost Where additional equipment is required by chosen options, additional equipment will be charged at the prices shown.

PV Panel van K Kombi

Volkswagen Commercial Vehicles may change RRP's at any time (this includes where there are government changes in regulation and/or legislation). There may be a delay to any RRP displaying correctly on our materials. Always obtain prices from your chosen authorised Van Centre.

Upgrade with the Business Pack.

Your Volkswagen Transporter can now feature rear parking sensors, air-conditioning and an alarm for as little as £865 +VAT. This pack provides you and your business with savings on some of our most popular and valuable features, so your business can stay ahead of the curve without breaking the bank. Available on Startline models.



Options – Panel van and kombi (continued).

Packages.	PR Code.		Startline.		Trendline.		Highline.		Sportline.	
			Basic exc. VAT	Total RRP inc. VAT	Basic exc. VAT	Total RRP inc. VAT	Basic exc. VAT	Total RRP inc. VAT	Basic exc. VAT	Total RRP inc. VAT
Business Pack. Air conditioning component. Anti-theft alarm system with interior monitoring in cab, back-up horn and tow-away protection. Climatic cab air conditioning system (semi-automatic). Parking sensors, rear.	W56	PV/K	£865.00	£1,038.00	-	-	-	-	-	-
Comfort dash with wide centre console and bottle compartment. Only in combination with a single front passenger seat, carpet floor in cab, decorative insert in anthracite or decorative insert in outside body colour and removal of front socket at additional cost.	4N3	K	-	-	-	-	£430.00	£516.00	●	●
Front fog lights with cornering lights.	8WH	PV/K	£325.00	£390.00	£325.00	£390.00	●	●	●	●
LED headlights with LED daytime running lights. Only in combination with headlight washer system, heated washer nozzles and washer fluid level indicator.	PXF	PV/K	-	-	£1,220.00	£1,464.00	£1,220.00	£1,464.00	-	-
LED headlights with LED daytime running lights and LED tail lights. Only in combination with a tailgate.	PXE	PV/K	-	-	£1,510.00	£1,812.00	£1,510.00	£1,812.00	●	●
Non-smoker's pack. 12V socket and cup holder in dashboard.	9JA	PV/K	●	●	●	●	●	●	●	●
Wing mirrors, folding. Heated, electrically adjustable and folding wing mirrors. Body-coloured for Trendline and Highline.	ZB3	PV/K	£205.00	£246.00	£205.00	£246.00	£205.00	£246.00	●	●

● Standard - Not available ○ At no extra cost Where additional equipment is required by chosen options, additional equipment will be charged at the prices shown.

PV Panel van K Kombi

Volkswagen Commercial Vehicles may change RRP's at any time (this includes where there are government changes in regulation and/or legislation). There may be a delay to any RRP displaying correctly on our materials. Always obtain prices from your chosen authorised Van Centre.

Upgrade with the Business Pack.

Your Volkswagen Transporter can now feature rear parking sensors, air-conditioning and an alarm for as little as £865 +VAT. This pack provides you and your business with savings on some of our most popular and valuable features, so your business can stay ahead of the curve without breaking the bank. Available on Startline models.



Options – Panel van and kombi (continued).

Body and chassis.	PR Code.		Startline.		Trendline.		Highline.		Sportline.	
			Basic exc. VAT	Total RRP inc. VAT	Basic exc. VAT	Total RRP inc. VAT	Basic exc. VAT	Total RRP inc. VAT	Basic exc. VAT	Total RRP inc. VAT
Differential lock. 4MOTION only.	1Y4	PV/K	£545.00	£654.00	£545.00	£654.00	£545.00	£654.00	-	-
Electric sliding doors, driver and passenger side. Only in combination with either Climatic cab air conditioning system (semi-automatic), or Climatic cab A/C (semi-automatic) with manually controlled passenger compartment heating system, or Climatic cab and passenger compartment A /C (semi-automatic) with second heating system in passenger compartment and four remote control folding keys at an additional cost.	PT4	K	£785.00	£942.00	£785.00	£942.00	£785.00	£942.00	£785.00	£942.00
Roof, high, body-coloured painted plastic with high rear wing doors without windows. LWB only.	ZD7	PV/K	£1,230.00	£1,476.00	£1,230.00	£1,476.00	£1,230.00	£1,476.00	-	-
Roof, high, Candy White plastic with high rear wing doors without windows. LWB only.	ZD3	PV/K	£1,125.00	£1,350.00	£1,125.00	£1,350.00	£1,125.00	£1,350.00	-	-
Manual side sliding door, driver side.	5R2	PV	£515.00	£618.00	£515.00	£618.00	£515.00	£618.00	£515.00	£618.00
		K	£515.00	£618.00	£515.00	£618.00	£515.00	£618.00	●	●
Manual side sliding door, passenger side.	5Q2	PV/K	●	●	●	●	●	●	●	●
Mudflaps.	6N2	PV/K	£130.00	£156.00	£130.00	£156.00	£130.00	£156.00	£130.00	£156.00
Power latching for driver side sliding door. Only in combination with manual side sliding door, driver side, at an additional cost.	GX3/5R2/5Q0	PV/K	£120.00	£144.00	£120.00	£144.00	£120.00	£144.00	●	●
Power latching for passenger side sliding door.	GZ3	PV/K	£120.00	£144.00	£120.00	£144.00	£120.00	£144.00	●	●
Power latching for tailgate. On a panel van, only in combination with a tailgate and load floor covering at an additional cost.	GY1	PV/K	£115.00	£138.00	£115.00	£138.00	£115.00	£138.00	-	-
Rear wing doors with 250° hinges. LWB only.	5V4	PV/K	£305.00	£366.00	£305.00	£366.00	-	-	-	-
Rear wing doors with heated windows.	ZH1	K	£180.00	£216.00	£180.00	£216.00	£180.00	£216.00	-	-
Rear wing doors without windows.	ZH2 or 3RD/4H0	PV	●	●	●	●	●	●	-	-

● Standard – Not available ○ At no extra cost Where additional equipment is required by chosen options, additional equipment will be charged at the prices shown.

PV Panel van K Kombi

Volkswagen Commercial Vehicles may change RRP's at any time (this includes where there are government changes in regulation and/or legislation). There may be a delay to any RRP displaying correctly on our materials. Always obtain prices from your chosen authorised Van Centre.

Options – Panel van and kombi (continued).

Body and chassis.	PR Code.		Startline.		Trendline.		Highline.		Sportline.	
			Basic exc. VAT	Total RRP inc. VAT	Basic exc. VAT	Total RRP inc. VAT	Basic exc. VAT	Total RRP inc. VAT	Basic exc. VAT	Total RRP inc. VAT
Tailgate with heated rear window.	ZH7	PV	○	○	○	○	○	○	-	-
	4E0	K	●	●	●	●	●	●	●	●
Tailgate without rear window.	ZH6	PV	○	○	○	○	○	○	●	●
	3RB/4E0/4H2	K	○	○	○	○	○	○	○	○
Tailgate, electric with rear window and power latching. On a panel van, only in combination with rubber load floor covering at an additional cost.	ZEH	PV/K	£520.00	£624.00	£520.00	£624.00	£520.00	£624.00	-	-
Towbar, fixed. Includes trailer stabilisation.	1D1	PV/K	£450.00	£540.00	£450.00	£540.00	£450.00	£540.00	£450.00	£540.00
Towbar preparation. Includes trailer stabilisation.	1D7	PV/K	£205.00	£246.00	£205.00	£246.00	£205.00	£246.00	●	●
Towbar, removable/lockable. Includes trailer stabilisation.	1D2	PV/K	£560.00	£672.00	£560.00	£672.00	£560.00	£672.00	£560.00	£672.00
Without model designation badge.	ONM	PV/K	○	○	○	○	○	○	-	-
Cargo area.										
Bulkhead, full with fixed window, including eight load-lashing rings.	ZZ3	PV	£115.00	£138.00	£115.00	£138.00	£115.00	£138.00	£115.00	£138.00
Bulkhead, full without window, including eight load-lashing rings.	ZZ2	PV	●	●	●	●	●	●	●	●
Carpet flooring in cab.	5AD	PV	£90.00	£108.00	£90.00	£108.00	£90.00	£108.00	£90.00	£108.00
		K	£90.00	£108.00	£90.00	£108.00	£90.00	£108.00	●	●
Load side lining, half-height.	5DV	PV	●	●	●	●	●	●	●	●
Rubber floor covering in cab.	5AC	PV	●	●	●	●	●	●	●	●
		K	●	●	●	●	●	●	-	-

● Standard – Not available ○ At no extra cost Where additional equipment is required by chosen options, additional equipment will be charged at the prices shown.

PV Panel van K Kombi

Volkswagen Commercial Vehicles may change RRP's at any time (this includes where there are government changes in regulation and/or legislation). There may be a delay to any RRP displaying correctly on our materials. Always obtain prices from your chosen authorised Van Centre.

Options – Panel van and kombi (continued).

Electrical.	PR Code.		Startline.		Trendline.		Highline.		Sportline.	
			Basic exc. VAT	Total RRP inc. VAT	Basic exc. VAT	Total RRP inc. VAT	Basic exc. VAT	Total RRP inc. VAT	Basic exc. VAT	Total RRP inc. VAT
Electrical interface for external use. Terminal block in driver seat.	IS1	PV/K	£60.00	£72.00	£60.00	£72.00	£60.00	£72.00	£60.00	£72.00
Electrical interface and multi-function control module for external use.	IS2	PV/K	£325.00	£390.00	£325.00	£390.00	£325.00	£390.00	£325.00	£390.00
Second maintenance-free battery with cut-off relay.	8FB	PV/K	£225.00	£270.00	£225.00	£270.00	£225.00	£270.00	£225.00	£270.00
Heating and ventilation.										
Climatic cab air conditioning system (semi-automatic). See Business Pack offer.	9AP	PV/K	£915.00	£1,098.00	£915.00	£1,098.00	●	●	●	●
Climatic cab air conditioning system (semi-automatic) with manually controlled passenger/load compartment heating system.	KH1/KK1	PV/K	£1,095.00	£1,314.00	£1,095.00	£1,314.00	£560.00	£672.00	£560.00	£672.00
Manually controlled cab heating system.	9AA	PV/K	●	●	●	●	-	-	-	-
Programmable parking heater (air) with radio remote control, auxiliary heater (coolant-based) and second battery. Provides an auxiliary heater combined with a supplementary air heater. The two heaters heat the vehicle when parked and support the engine to heat the vehicle when cold. The supplementary heater is controlled via the remote control or the operating unit in the roof which has settings for the switch-on time, day and temperature - includes second battery.	PW5	PV/K	£2,295.00	£2,754.00	£2,295.00	£2,754.00	£2,295.00	£2,754.00	£2,295.00	£2,754.00

● Standard – Not available ○ At no extra cost Where additional equipment is required by chosen options, additional equipment will be charged at the prices shown.

PV Panel van K Kombi

Volkswagen Commercial Vehicles may change RRP's at any time (this includes where there are government changes in regulation and/or legislation). There may be a delay to any RRP displaying correctly on our materials. Always obtain prices from your chosen authorised Van Centre.

Upgrade with the Business Pack.

Your Volkswagen Transporter can now feature rear parking sensors, air-conditioning and an alarm for as little as £865 +VAT. This pack provides you and your business with savings on some of our most popular and valuable features, so your business can stay ahead of the curve without breaking the bank. Available on Startline models.



Options – Panel van and kombi (continued).

Safety and security.	PR Code.		Startline.		Trendline.		Highline.		Sportline.	
			Basic exc. VAT	Total RRP inc. VAT	Basic exc. VAT	Total RRP inc. VAT	Basic exc. VAT	Total RRP inc. VAT	Basic exc. VAT	Total RRP inc. VAT
Airbags, driver and front passenger with seatbelt tensioners and passenger airbag deactivation.	4UF	PV/K	●	●	●	●	●	●	●	●
Airbags, front passenger, deleted.	4UC/5XK	PV/K	○	○	○	○	○	○	○	○
Anti-theft alarm system with interior monitoring in cab, back-up horn and tow-away protection.	7AQ	PV/K	£195.00	£234.00	£195.00	£234.00	●	●	●	●
Electronic engine immobiliser.	7AA	PV/K	●	●	●	●	-	-	-	-
First aid kit with warning triangle and safety vest.	1T9	PV/K	£50.00	£60.00	£50.00	£60.00	£50.00	£60.00	£50.00	£60.00
Four remote control folding keys. Two additional remote folding keys.	8QM	PV/K	£95.00	£114.00	£95.00	£114.00	£95.00	£114.00	£95.00	£114.00
Two remote control folding keys.	8QJ	PV/K	●	●	●	●	●	●	●	●
Windows.										
Heat insulating glass (Green) in cab.	QL3	PV	●	●	●	●	●	●	●	●
Heat insulating glass (Green) in cab and passenger/load compartment.	QL3	K	●	●	-	-	-	-	-	-
Privacy glass in passenger compartment with heat insulating glass (Green) in cab.	QL5	K	-	-	●	●	●	●	●	●
Rear window, heated with wash-wipe.	4HS	PV	£130.00	£156.00	£130.00	£156.00	£130.00	£156.00	£130.00	£156.00
		K	●	●	●	●	●	●	●	●

● Standard – Not available ○ At no extra cost Where additional equipment is required by chosen options, additional equipment will be charged at the prices shown.

PV Panel van K Kombi

Volkswagen Commercial Vehicles may change RRP's at any time (this includes where there are government changes in regulation and/or legislation). There may be a delay to any RRP displaying correctly on our materials. Always obtain prices from your chosen authorised Van Centre.

Finance made simple.

As dedicated to finance as we are to your new Transporter.

Learn more about our range of finance products to find a finance package that suits your budget.

Alternatively, 'Click on' the Offers & Finance button above to find out more about our latest offers to help your business thrive.

Cost of your vehicle

Deposit
As little as one monthly repayment

Monthly repayments
Spread across 18 to 49 months

Optional final payment
You have three choices at the end of your agreement



Own Hire

Cost of your vehicle

Deposit
As little as one monthly repayment

Repayments
Spread across 12 to 60 months



Own

Cost of your vehicle

Deposit
As little as one monthly repayment

Rental repayments
Spread across 12 to 48 months

Final 'balloon' repayment



Own

Solutions Personal Contract Plan

Not sure if you want to own or hire? Make the decision later. Pay monthly payments for the length of your agreement. At the end you can decide to keep (once all payments have been made), upgrade or return the vehicle.

Hire Purchase

Make all the regular monthly payments. At the end the vehicles is yours.

Lease Purchase

Make lower monthly payments by deferring an amount until the end. Once paid the vehicle is yours.

Cost of your vehicle

Initial rental
As little as one rental repayment

Rental repayments
Spread across 12 to 60 months



Hire

Cost of your vehicle

Initial rental
As little as one rental repayment in advance

Rental repayments
Spread across 12 to 60 months



Hire

Cost of your vehicle

Initial rental
As little as one rental repayment in advance

Rental repayments
Spread across 12 to 48 months

Final 'balloon' repayment
You have two options at the end of your agreement



Hire

Contract Hire

Pay fixed monthly rentals to hire the vehicle. Look after it so at the end you can return it hassle free.

Finance Lease (full pay out)

Pay monthly rentals to hire the vehicle. At the end you have two options. Sell the vehicle and receive a percentage of the sale proceeds. Or retain the use of your vehicle by paying a reduced annual rental.

Finance Lease (balloon repayment)

Pay monthly rentals to hire the vehicle. At the end you have two options. Sell the vehicle to settle the outstanding amount and receive any excess sale proceeds. Or pay the 'balloon' payment and retain the use of your vehicle by paying a reduced annual rental.

Finance subject to status. Available to 18s and over in the UK only. Terms and Conditions apply. Volkswagen Commercial Vehicle Financial Services.

Service & warranties.

Finance and insurance.¹

When it comes to paying for your van, we've got options including Contract Hire and Finance Lease, or Hire Purchase. We can also offer you competitive insurance.

A choice of packages.²

Whether you prefer to lease your vehicles, with none of the concerns of ownership and the freedom to change models easily, or purchase outright to own the vehicle that's perfect for your business, we're here to help you consider your options.

You can go flexible, by choosing a payment plan that suits your finances, with options to reduce your monthly costs and your repayment period. Or choose a fixed monthly price that allows you to budget confidently for the longer term.

You can even include your road tax and servicing costs to arrive at one simple, all-inclusive payment. For more information, pick up a finance brochure, or ask at your Van Centre.

Volkswagen insurance.

Volkswagen Commercial Vehicles Insurance¹ provides cost-effective and comprehensive motor insurance³, as well as gap insurance⁴, which helps replace your vehicle and protect you from any financial shortfall if it's written off.

Insurance benefits include:

- Complimentary 5-day drive away insurance cover.
- All repairs performed by approved repairers.
- Volkswagen Genuine Parts[®] used on all repairs.
- Courtesy vehicle provided during repair following an accident (subject to availability).
- Cover for breakage and damage to glass.
- In-vehicle personal belongings cover (up to £250).
- Vehicle recovery.
- 90-day European Union cover.

For more information about our motor insurance call: **0345 877 6355** (lines open 9am-6pm Monday-Friday) or visit: insurewithwvcv.co.uk

Servicing and support.

We're here to keep your business moving, with our range of three award-winning⁵ servicing and maintenance options, as well as free Roadside Assistance. Some exclusions apply. For more detail, please visit www.volkswagen-vans.co.uk/aftersales.

Pay monthly.

This option is available for vehicles that are less than 12 months old and have covered less than 10,000 miles. It makes budgeting easier by splitting the cost of servicing into fixed monthly payments – whether you want Service only; Service and Maintenance; or Service, Maintenance and Tyres.

Pay upfront.⁶

If you can pay for more than one service upfront, we'll help by reducing your costs. Buy two upfront and you'll receive one interim and one full service at a discounted rate. Buy four and you'll receive two interim and two full services, with your next MOT also included.

Pay on demand.

If you're looking for freedom and flexibility with your servicing, it's good to know we're ready when you are. So with our third option, you can choose to pay for your services as and when you need them, with our National Service Pricing. Ask your Van Centre for an up-to-date pricing guide.

Roadside Assistance.

We understand the need to keep you mobile. That's why all new vans come with three-year, unlimited mileage roadside cover. Should the unexpected happen, one call gets you straight through to a team trained to help you through any breakdown or accident. Supporting you every day will be a team of vehicle technicians, fully-trained by Volkswagen and carrying the latest diagnostic equipment, specialist tools and parts.

Assistance benefits include:

- Assistance at home, by the roadside or place of work.
- Recovery to your preferred location.
- Onward travel, for you and your cargo.
- Cover 24 hours a day, 365 days a year.
- Free cover for three years (on new vehicles).
- Unlimited mileage.
- European cover.
- Option to extend cover beyond three years.

Warranties.

You can count on us long after you purchase your Transporter, thanks to its comprehensive three-year, 100,000 mile warranty. You choose Volkswagen because your business depends on it, year in, year out. While your Transporter is under warranty, we'll fix any defect in manufacture or workmanship free of charge, even if you purchase and service the vehicle at different Van Centres. Some exclusions apply and the vehicle must be cared for using the guidance in your owner's manual. For more detail, please visit www.volkswagen-vans.co.uk/aftersales.

Extended warranty.

You can also extend your warranty beyond the three-year, 100,000 mile period, choosing either Comprehensive or Major Component cover, as a one-off or monthly payment. For more detail of cover levels, along with terms and conditions, please visit volkswagenwarranty.co.uk where you'll also be able to obtain a quote and purchase an extended warranty.

Paint and body warranty.

Your Transporter's exterior paintwork is covered against manufacturing defects for a period of three years, while its body sections and panels are covered against rusting through from the inside for 12 years. Some exclusions apply and the vehicle must be cared for using the guidance in your owner's manual.

Add Ons

Accessories to help keep your vehicle **100%** Volkswagen

Add extra style, protection and practicality to your van, while still keeping it 100% Volkswagen.

Add more with Add Ons...

Accessories allow you to go beyond options and truly customise your van. You might want extra capacity with roof attachments or a tow bar, add cab technology or even convert a work van into a weekend leisure vehicle.

Keep it 100% Volkswagen.

There are big advantages to purchasing approved accessories from us. Add Ons have all been designed with your Volkswagen in mind, so they're a perfect match for fit and style. They're built to be rugged, reliable and long-lasting.

Keep your Add Ons covered.

Most Add Ons include a two-year warranty, but the great news is that if you order and fit them when you purchase a new van, we may be able to extend that to three years to match your vehicle's warranty. Ask your Van Centre for more detail.

- 1 Volkswagen Commercial Vehicles Insurance and Volkswagen Commercial Vehicle Financial Services are trading names of Volkswagen Financial Services (UK) Limited, Brunswick Court, Yeomans Drive, Blakelands, Milton Keynes MK14 5LR, which is authorised and regulated by the Financial Conduct Authority (FCA). Registered in England and Wales No. 2835230. Volkswagen Financial Services (UK) Limited financial services register number is 311988.
- 2 An offer of finance depends on certain conditions. Finance subject to status. Available to 18s and over. Terms and conditions apply. Volkswagen Commercial Vehicle Financial Services.
- 3 Volkswagen Commercial Vehicle Insurance is arranged by U K Insurance Business Solutions Limited and is underwritten by U K Insurance Limited. U K Insurance Business Solutions Limited is authorised and regulated by the Financial Conduct Authority and U K Insurance Limited is authorised by the Prudential Regulation Authority and regulated by the Financial Conduct Authority and the Prudential Regulation Authority. U K Insurance Business Solutions Limited. Registered office: Churchill Court, Westmoreland Road, Bromley, Kent BR1 1DP. Registered in England and Wales No. 05196274. Calls may be recorded.
- 4 Volkswagen Commercial Vehicle Insurance gap insurance is underwritten by MAPFRE Asistencia Compañía Internacional de Seguros y Reaseguros Sociedad Anonima authorised by Dirección General de Seguros y Fondos de Pensiones and subject to limited regulation by the Financial Conduct Authority and Prudential Regulation Authority, number 203041. Details about the extent of their regulation by the Financial Conduct Authority and Prudential Regulation Authority are available on request. MAPFRE Asistencia Compañía Internacional de Seguros y Reaseguros Sociedad Anonima is incorporated and registered in the Kingdom of Spain and registered as a foreign company in the United Kingdom with company number FC021974, acting through its UK branch with branch number BR008042 and whose principal office is at Alpha House, 5th Floor, 24A Lime Street, London EC3M 7HS. Volkswagen Commercial Vehicle Insurance gap insurance is administered by Abraxas Insurance Administration Services Limited, who is authorised and regulated by the Financial Conduct Authority with FCA number 308702 and who acts on behalf of the Insurer. Abraxas Insurance Administration Services Limited is registered in England and Wales with company number: 02928787 and whose registered office is at One Glass Wharf, Bristol BS2 0SX. Volkswagen Financial Services (UK) Limited is authorised and regulated by the Financial Conduct Authority (FCA). Authorisation details can be checked on the Financial Services register at www.fca.org.uk/firms/systems-reporting/register or call 0800 111 6768. Volkswagen Financial Services (UK) Limited is not part of the same corporate group as MAPFRE Asistencia Compañía Internacional de Seguros y Reaseguros Sociedad Anonima and Abraxas Insurance Administration Service Limited.
- 5 Business Vans Awards 2014 and 2015: Best Service Package for Van Owners.
- 6 Class 4 MOT only. This option is available to all new and used vehicles up to four years old or with less than 80,000 miles on the clock. Services must be used consecutively prior to vehicle reaching eight years old.

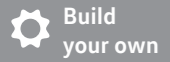

Build
your own



Find a
Van Centre



Test drive



Offers &
Finance



Conversions



Comparator



The Transporter

This brochure supersedes all previous publications.

Issue: 8 May 2019

www.volkswagen-vans.co.uk

Please note: Screen technology does not allow exact reproduction of the paint and upholstery colours. Some of the vehicles shown are European specification and may be fitted with optional equipment or accessories that are available at extra cost, or do not reflect current specification. All data and specifications are in accordance with information available at the time of publication and are subject to change without notice. Vehicles not currently in UK stock and customer order vehicles may take a number of weeks for delivery. Certain combinations of vehicle specifications and factory-fitted options are not compatible and therefore all orders received are subject to confirmation. Models, factory fitted-options and paint and upholstery options are subject to availability. Please check details and availability with an authorised Volkswagen Van Centre at the time of ordering.