



Commercial
Vehicles

The Caravelle



Contents

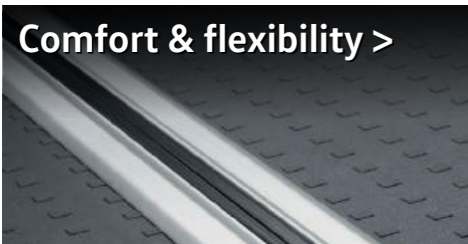

Designed to make a statement.

The Caravelle demonstrates stylish design, yet still remains true to its roots. With assured styling, defined contours, large windows and striking features such as dynamic LED tail lights, it's designed to make a statement. The Caravelle is available with a range of stylish alloy wheels, a wide selection of attractive exterior paint colours and sumptuous upholsteries – all designed to help it stand out from the crowd.



Optional LED headlights with low energy LED daytime running lights.



Standard low energy LED tail lights.



Interior shown is Caravelle Executive.

Comfort & flexibility.

The Caravelle offers a world of possibility when it comes to combining flexibility and space. Featuring moulded trim and deluxe headlining, sumptuous upholstery, heat insulating glass, rear heating systems, multiple air vents and sunblinds on the rear side windows – it delivers a comfortable and controlled atmosphere that feels like home. Seating up to seven including the driver, the Caravelle incorporates 360° swivelling and folding seats on the second row with an inviting three-seat bench at the rear. The clever floor-mounted rail system enables rear seats and the multi-functional table (which folds, swivels and adjusts for height), to be located securely in countless configurations. If required, rear seating can be removed to create a large, flat load area. In fact, when you need to comfortably carry a large number of passengers, as well as their luggage, the Caravelle is hard to beat.



Standard seating for seven – standard layout for short and long wheelbase.



The Caravelle's ingenious floor-mounted rail system shown with optional rubber flooring.



Standard 360° swivelling and removable seats in the second row.



Interior shown is Caravelle Executive.

Infotainment systems.

When you get behind the wheel of the Caravelle, you'll be greeted by an ergonomic, high specification interior with quality finishing and an exclusive atmosphere. What's more, we've taken things a step further by offering a range of stylish and innovative radio and infotainment systems, all designed to help the miles fly by.





Composition Colour DAB+ radio system.

Fitted as standard, the Composition Colour DAB+ radio system features a 5" TFT touch-screen colour display, USB port, Bluetooth®, SD card slot, AUX-IN interface, MP3 and WMA compatible CD drive, 4 x 20 watt output with six speakers and a dual tuner with PhaseDiversity for optimum radio reception.



Optional Composition Media DAB+ radio system.

The optional Composition Media DAB+ radio system features an increased touch-screen size of 6.33" with proximity sensor, USB port, Bluetooth®, SD card slot, AUX-IN interface, MP3 and WMA compatible CD drive, 4 x 20 watt output with six speakers and a dual tuner with PhaseDiversity for optimum radio reception. App-Connect is available as an option for this system.

Radio and navigation. Devices include the standard Composition Colour touch-screen DAB+ radio system and optional Composition Media DAB+ radio system, Discover Media navigation system and Discover Media navigation system plus.

Voice control.² Available as an option with voice enhancement in conjunction with the Composition Media DAB+ radio system or Discover Media navigation system, the voice control system allows you to operate the telephone, navigation and audio functions without taking your hands off the steering wheel.

Connectivity. Available as an option with the Composition Media DAB+ radio system or Discover Media navigation system. External media devices, such as MP3 players, can be connected via an additional USB port. Additionally, the standard mobile phone interface offers a Bluetooth® hands-free speaking system.

Volkswagen Media Control. Available as an option with the Discover Media Navigation plus system, your smartphone or tablet is turned into a remote control and is able to operate the audio system functions from the rear seats via a Wi-Fi connection.



Optional Discover Media navigation system with App-Connect.

The optional Discover Media satellite navigation system builds on the strengths of the Composition Media DAB+ radio system by adding satellite navigation and a second integrated SD card slot compatible for map data. The system includes free updates for the pre-installed European maps through Volkswagen MapCare. App-Connect is available as an option for this system.



Optional App-Connect¹.

Available as an option in conjunction with the Composition Media DAB+ radio system or Discover Media navigation system, App-Connect allows you to operate special apps. The screen of your smartphone can be shown on the radio system's display.

1 The 'App' control button on the optional Discover Media navigation system is only enabled when ordered in conjunction with the optional App-Connect system.
 2 The 'Voice' control button on the optional Composition Media DAB+ radio system or Discover Media navigation system is only enabled when ordered in conjunction with the optional Voice control system.

Mobile online services.

Optional App-Connect – Volkswagen apps.¹

Download special Volkswagen apps to your mobile or tablet, such as 'Shared Audio', 'Drive & Track', 'Call & Remind', 'My Guide' and 'Sound Journey' to make every journey more pleasant and interesting. The apps provide you with information about your driving behaviour, guide you to parking spaces in the vicinity, make detailed suggestions about exciting destinations – all taking into account the weather and traffic data.

Optional Car-Net Guide & Inform.²

Use Car-Net Guide & Inform to enhance your vehicle's optional Discover Media navigation system with online-based, up-to-date information services for greater convenience when travelling. For example, utilise real-time traffic information to avoid a sudden traffic jam, or refuel at the cheapest fuel station, or find a free parking space without the need for an infuriating search. Car-Net Guide & Inform helps you to reach your destination quickly and with the least amount of stress.



Online traffic information.

Save time and avoid stress with real-time traffic information, enabling you to avoid traffic jams by dynamically adapting your route.



News.

Subscribe to personalised news categories and use the news feeds to stay up-to-date.



Fuel stations.³

View the fuel stations with the cheapest fuel prices in your immediate vicinity. Your vehicle's fuel type is automatically identified.



Online destination import.

Conveniently plan your driving destinations from home using the customer portal and retrieve them using the navigation system.



Parking spaces.³

Save time and view available parking options, along with prices and opening hours.



My special destinations.

Use the customer portal to save your preferred destinations while at home and import these into your vehicle's navigation system.



Weather.

Stay up-to-date with the latest weather information while on the move.



Vehicle status report.

Retrieve the latest service information and error messages from your vehicle.



Online special destination search.

Customised information about local services is sent directly to your touch-screen display.



Car-Net registration in a few easy steps:

1. Create your personal account on the Car-Net website.
2. You will receive a registration code (PIN).
3. Enter your vehicle identification number (VIN).
4. Enter the PIN into your vehicle's navigation system.

¹ Available as an option, App-Connect is only available in conjunction with the Composition Media DAB+ radio system or the Discover Media satellite navigation system. App-Connect comprises MirrorLink™, CarPlay™ and Android Auto™. The availability of these technologies can vary depending on the country in question. Please note that App-Connect is not currently supported by all mobile telephones on the market. Volkswagen is working closely with major smartphone producers to promote broader compatibility for App-Connect.

² Available as an option, mobile online services (Car-Net) is only available in conjunction with the Discover Media satellite navigation system. You will also require a mobile device that is capable of acting as a mobile wireless hotspot. Car-Net services are only available with an existing mobile network contract or one to be agreed separately for this purpose between you and your mobile phone network provider and only within the respective mobile phone network coverage. Depending on your mobile phone tariff, receiving data from the internet may incur additional charges, particularly if you are using the phone abroad. Due to the amount of data needed when using Car-Net services, we strongly recommend signing-up to a data flat rate with your mobile phone provider. Use of Car-Net is governed in a separate agreement with Volkswagen AG online. After taking possession of the vehicle, you have 90 days in which to register the vehicle at www.volkswagen-commercial-vehicles-carnet.com. The availability of Car-Net services may vary depending on the country in question. These services are available for the duration of the contract term agreed and may be subject to changes in terms of content during the contract period. More detailed information on Car-Net is available at www.volkswagen-commercial-vehicles-carnet.com and from your Volkswagen Commercial Vehicles Van Centre. Contact your mobile network provider for information regarding your mobile network tariff.

³ Available at participating fuel stations and car parks.

Safety systems.

Your safety is vital, so we ensure that a long list of safety and security features are built into every vehicle we produce.

Since we first introduced structural safety features on commercial vehicles over 35 years ago, Volkswagen has maintained a policy of continuous safety development. Every Volkswagen model incorporates a range of both active and passive safety features, to help ensure the safety and security of both you, your passengers and your load.

With the vehicle's design contributing to safety, occupants are securely enclosed within a rigid safety cell with crumple zones to absorb crash energy, while the chassis and suspension are designed for excellent directional stability and handling. Features such as Anti-lock Braking System (ABS), Electronic Brakeforce Distribution (EBD), Electronic Stabilisation Programme (ESP), driver and passenger front and side airbags, front fog lights with integrated cornering lights, electric seatbelt tensioners, Automatic Post-Collision Braking System and four ISOFIX child seat mountings in the rear passenger area are fitted as standard.

For additional security and protection, an electronic immobiliser and remote central locking with dead locking and internal locking button are standard, while optional features such as front and rear parking sensors, LED headlights, 4MOTION all-wheel drive and standard on Executive models as part of the Lights & Vision pack, automatic rain-sensing wipers all offer additional peace-of-mind.



Electronic Stabilisation Programme (ESP).

Designed to prevent the vehicle from swerving in critical driving conditions by controlled and targeted intervention in the brake and engine management. This helps to maximise directional stability.



Anti-lock Braking System (ABS).

Designed to prevent wheels from locking up and assist manoeuvrability of the vehicle under heavy braking.



Traction Control System (TCS).

Aids smooth starts and acceleration by reducing wheel-spin. The system also incorporates the Electronic Differential Lock (EDL) and makes up part of the Electronic Stabilisation Programme (ESP).



Electronic Differential Lock (EDL).

Allows smooth starts on slippery or loose road surfaces. If one wheel starts to spin, EDL will brake the wheel as necessary, directing power to the wheel with greater traction.



Airbags.

Driver and passenger front airbags are standard for the first time. They offer occupants improved protection in the event of head-on impacts.



Seatbelt warning.

The seatbelt warning reminds the driver that their seatbelt is not fastened. Audio and visual signals are used to request that the seatbelt is fastened before driving.

Watch video >



Automatic Post-Collision Braking System.

Standard on all Caravelle models, it triggers braking after a collision, with the aim of preventing secondary collisions.

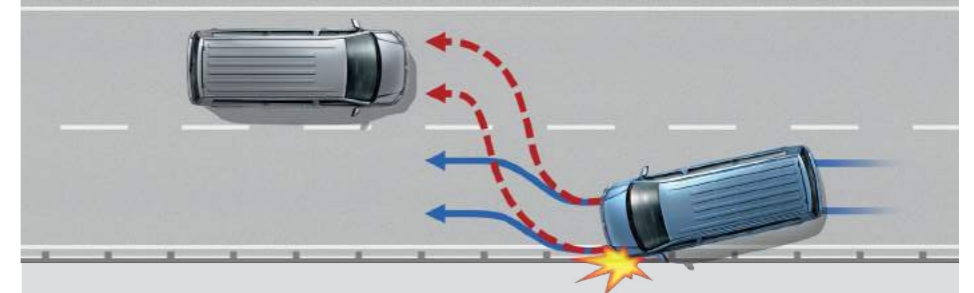

Driver assistance systems.







To help ensure every journey ends as stress-free as it begins, the Caravelle is equipped with a number of technologically advanced systems – all of which are activated in critical situations as a preventative measure. Add to this a variety of innovative driver assistance systems and you'll discover the Caravelle offers high levels of safety and peace-of-mind.



Optional parking sensor display.



Optional rear-view camera display.

 <p>Cruise control. Standard on Executive and optional on SE, cruise control maintains the selected speed.</p>	 <p>Brake Assist. Fitted as standard, the system registers the speed at which the brake pedal is pressed. During emergency braking, it helps ensure full brake pressure is applied more quickly.</p>	 <p>Hill Hold Assist. Fitted as standard, the convenient Hill Hold Assist helps to prevent your vehicle from rolling back when pulling away on an incline. The hold operates for approximately two seconds.</p>
 <p>Driver Alert System. Fitted as standard, the Driver Alert System registers deviation from normal steering patterns and uses visual and acoustic warnings to recommend that the driver takes a break.</p>	 <p>Daytime running lights. Fitted as standard, daytime running lights offer increased visibility. For extra driver convenience, the dipped beam headlights are automatically switched on when you start your vehicle.</p>	 <p>Tyre pressure monitoring. The standard tyre pressure monitoring display activates a warning signal to highlight significant changes in tyre pressure. This lets the driver know that the tyre pressure should be checked as soon as possible.</p>

An intelligent driving experience. Assistance when you need it.

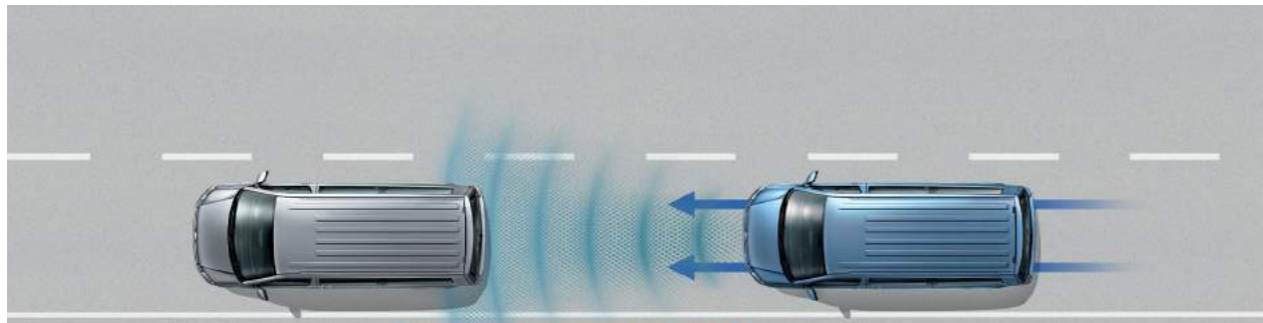

Front Assist with City Emergency Braking System.

The standard Front Assist area monitoring system with City Emergency Braking System detects critical distances, warns of hazardous situations and when necessary, triggers emergency braking.



Adaptive Cruise Control (ACC).

Available as an option, Adaptive Cruise Control (ACC) uses a front radar to measure the distance (up to 120m) and speed relative to vehicles driving ahead. It automatically regulates the pre-set distance.



Lane Change Assist - Side Scan.

Available as an option on short wheelbase models only, Side Scan displays a warning signal on the exterior mirror as soon as one of its sensors detects a vehicle in a blind spot during a lane change.



High Beam Assist.

Available as an option, High Beam Assist automatically dips the headlights and prevents dazzle for oncoming vehicles, or vehicles travelling ahead. At night time at speeds of above 37mph, the system automatically switches the headlights to high-beam.

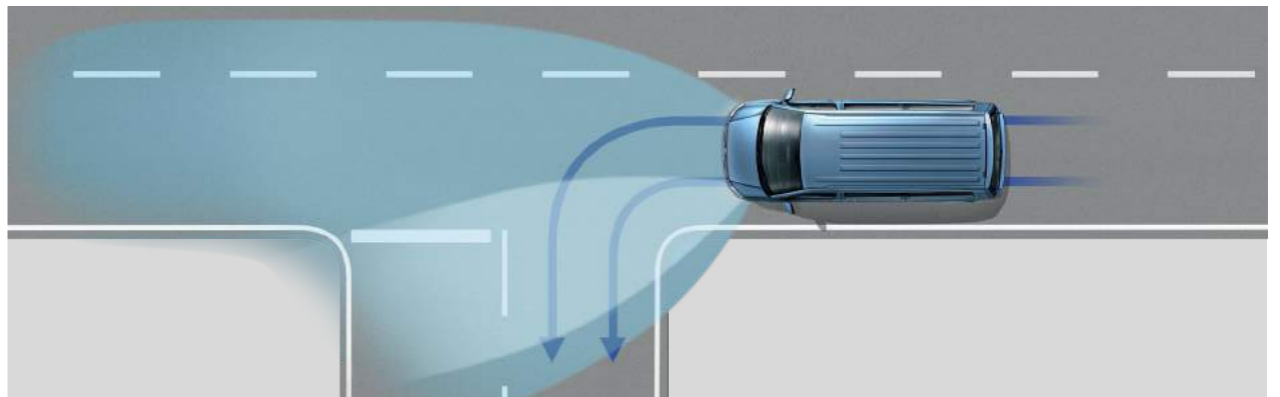

Fog lights with integrated cornering lights.

Fitted as standard on all Caravelles, these help to illuminate curves and bends in the road ahead. This aids the driver in spotting any obstacles where the vehicle is turning.

4MOTION all-wheel drive.

Available on Executive short wheelbase models with the 199PS BiTDI diesel engine, 4MOTION all-wheel drive offers a number of innovative features to help retain traction, optimum handling and outstanding steering response when encountering poor surface conditions.



4MOTION all-wheel drive.

The advantage of the Haldex clutch for the 4MOTION all-wheel drive is an improvement to vehicle handling and dynamics.

4MOTION all-wheel drive with DSG.

The Caravelle is the only vehicle in its class that's available with 4MOTION all-wheel drive and a 7-speed, dual clutch direct shift gearbox (DSG). This combination enables smooth driving on rugged terrain, thanks to its fully automatic gear change.

Hill Descent Control.

This useful option allows you to drive down steep slopes in a safe and controlled manner, thanks to the engine management's ability to govern the engine speed and apply the brakes if necessary. The vehicle's speed is maintained at a steady pace, without the driver needing to have additional input.

Mechanical differential lock.

The optional mechanical differential lock is available for the rear axle together with optional 4MOTION all-wheel drive. This helps to maintain traction when you encounter adverse conditions, such as rain, snow, mud or gravel.

Caravelle SE.

Designed for families and businesses alike, the Caravelle SE incorporates practicality, versatility and high levels of desirability. It's robust enough for a wide range of uses, yet cocoons passengers in a shell that's as safe as it is luxurious. To increase passenger comfort, features such as deluxe headlining with ventilation strips and integrated swivelling reading lights, Pandu cloth upholstery, heat-insulating glass and roller blinds for the rear side windows, help to create the right atmosphere. Combine this with twin power latching side sliding doors, Clayton or Devonport alloy wheels (depending on engine choice), front fog lights with cornering lights, body-coloured door mirrors, handles and bumpers with chrome detailing on the upper grille and you'll discover the SE is as desirable as it is practical.

Starting from
£43,083†

Please click here for more details.



Model shown is Caravelle SE short wheelbase.



Control unit for the Caravelle's optional auxiliary heater with programmable parking function, remote control and second battery.



Optional good night pack with window blinds, bed covering, storage under the three-seat rear bench, mini flashlight and waste bin.

† Volkswagen Commercial Vehicles may change RRP's at any time (this includes where there are government changes in regulation and/or legislation). There may be a delay to any RRP displaying correctly on our materials. Always obtain prices from your chosen authorised Van Centre.

Caravelle SE standard equipment.

Audio & communications.

Bluetooth® phone connectivity with trip computer and multi-function display plus.

Composition Colour DAB+ radio system with 5" touch-screen, single MP3 compatible CD drive, SD card slot, AUX-IN socket and six speakers.

USB connection in glove compartment or storage shelf.

Interior.

Carpet floor covering.

Climatic semi-automatic air conditioning with second heater in rear passenger area.

Comfort dashboard with wide centre console and bottle compartment.

Dark Silver brushed decorative trim with metallic Anthracite decorative insert in dash.

Deluxe headlining in passenger compartment with two ventilation strips and integrated swivelling reading lights.

Driver Alert System.

Driver and passenger seats with armrests, height and lumbar adjustment.

Electric front windows.

Grab handle on 'A' pillars for driver and front passenger.

Illuminated interior entry steps.

Interior light and reading lamps.

Leather steering wheel, gearknob and gaiter.

Lockable glove compartment.

Luggage compartment cover for three-seat rear bench.

Multi-functional table.

'Pandu' cloth upholstery.

Rail system for numerous seat and table configurations.

Six securing points in passenger and luggage compartment.

Sunblinds for side windows in rear passenger area.

Three-seat rear bench with ISOFIX child seat mounting points on outer two seats and top tether anchorage.

Two longitudinally adjustable, swivelling and removable seats with ISOFIX child seat mounting points.

12V socket.

Exterior.

Body-coloured door mirrors and handles, rear bumper and front bumper with chrome detailing in upper grille.

Daytime running lights.

Door mirrors – electrically heated and adjustable.

Exterior (continued).

Front fog lights with cornering lights.

Green heat insulating glass.

Halogen twin headlights.

LED tail lights.

Side sliding doors on driver and passenger side with power latching.

Tailgate with heated rear window and wash-wipe.

Safety and security.

Airbags – driver, front passenger (with deactivation switch), front seats with head and side airbags.

Anti-lock Braking System (ABS).

Brake Assist.

Child lock for doors and tailgate in passenger's compartment.

Electronic Brakeforce Distribution (EBD).

Electronic Differential Lock (EDL).

Electronic Stabilisation Programme (ESP).

First aid kit and warning triangle.

Front Assist with City Emergency Braking.

Height and rake adjustable steering column.

Hill Hold Assist.

Regenerative braking.

Remote central locking with interior locking switch and two remote folding keys.

Start/Stop.

Thatcham Category 1 approved alarm and immobiliser with tow-away protection.

Traction Control System (TCS).

Wheels and tyres.

16" x 6.5J Clayton alloy wheels fitted with 215/65 R16 low rolling resistance tyres (150PS short wheelbase).

17" x 7J Devonport alloy wheels fitted with 235/55 R17 low rolling resistance tyres (150PS long wheelbase and 199PS engine).

Full size steel spare wheel.

Tool kit and jack.

Efficiency technology.

Low rolling resistance tyres.

Regenerative braking.

Start/Stop.



16" Clayton alloy wheels. Standard on SE 150PS short wheelbase.



17" Devonport alloy wheels. Standard on SE 150PS long wheelbase and 199PS.



Composition Colour DAB+ radio system.

Caravelle Executive.

When your emphasis is on luxury and style, the Caravelle Executive offers the answer. On top of the comprehensive features found in the SE, you'll find additions that transform the Executive into a highly desirable vehicle for the discerning. From the moment you enter through its twin electric side sliding doors and stainless steel door steps, the quality is evident with sumptuous leather and Alcantara® upholstery, heated front seats, Climatronic three-zone automatic air conditioning and a deluxe instrument panel. Add to this a power latching tailgate, privacy glass, chrome exterior detailing and stylish 17" Cascavel two-tone black/silver diamond-turned alloy wheels and the Executive's exterior becomes a perfect match for its opulent interior.

Starting from **£47,133†** [Please click here for more details.](#)



01 The Executive's interior featuring the multi-function table – standard on both Executive and SE.

02 Optional above-cab electric sliding sunroof with sunblind.

03 Optional Digital Voice Enhancement (DVE) provides voice amplification in the passenger compartment.

† Volkswagen Commercial Vehicles may change RRP's at any time (this includes where there are government changes in regulation and/or legislation). There may be a delay to any RRP displaying correctly on our materials. Always obtain prices from your chosen authorised Van Centre.

Design	Comfort & flexibility	Infotainment systems	Mobile online services	Assistance systems	4MOTION all-wheel drive	Caravelle SE	Caravelle Executive	Paint, upholstery & trim	Wheels	Technical information	Price list	Offers & finance	Service & warranties
--------	-----------------------	----------------------	------------------------	--------------------	-------------------------	--------------	----------------------------	--------------------------	--------	-----------------------	------------	------------------	----------------------

Caravelle Executive equipment in addition to SE.

Interior.

- Automatically dimming rear-view mirror and rain sensor.
- Climatronic three-zone automatic air conditioning for driver, front passenger and rear passenger area.
- Cruise control.
- Deluxe instrument panel with four-eye instrument cluster, including TFT colour display and premium multi-function display.
- Folding centre armrest in three-seat bench.
- Heated front seats.
- Leather and Alcantara® upholstery.
- Leather multi-function steering wheel.
- Servotronic (speed dependent) power steering.
- Structural X decorative trim with Piano Black decorative insert in dash.

Exterior.

- Automatic headlight activation with daytime running lights.
- Chrome pack – chrome detailing on the sides, tailgate, front fog lights and lower front grille.
- Electric side sliding doors.
- Heated windscreen.
- Heated windscreen-washer jets.
- Privacy glass in rear passenger area.
- Stainless steel door steps and tailgate load sill.
- Tailgate – power latching.
- Washer fluid level indicator.

Safety and security.

- Four remote control folding keys.

Wheels and tyres.

- 17" x 7J Cascavel alloy wheels with black/silver diamond-turned surface.
- 235/55 R17 optimised rolling resistance tyres.
- Full size alloy spare wheel.



Electrically operated side sliding doors.



17" Cascavel alloy wheels with black/silver diamond-turned surface.



Cruise control. Featured as part of the leather multi-function steering wheel.



Leather and Alcantara® upholstery.



Climatronic three-zone automatic air conditioning and heated seats.



Chrome pack. Includes front fog lights with cornering lights, grille with chrome mouldings and chrome clamp.

Paint, upholstery & trim.

Formulated to withstand the rigours of everyday life, the Caravelle's paint and upholstery are designed to stand the test of time. As you'd expect from any Volkswagen, exterior paints offer a smooth and tough finish, while the interior upholstery is made from high-quality materials that are both attractive and robust.

Solid paint.



Candy White solid paint



Cherry Red solid paint



Reflex Silver metallic paint



Indium Grey metallic paint



Chestnut Brown metallic paint



Bamboo Garden Green metallic paint

Metallic paint.¹



Acapulco Blue metallic paint



Starlight Blue metallic paint



Mojave Beige metallic paint



Oryx White pearl effect paint



Deep Black pearl effect paint

Pearl effect paint.¹

Two tone paint.¹



Indium Grey upper / Deep Black pearl lower



Candy White upper / Indium Grey lower



Candy White upper / Bamboo Garden Green lower



Candy White upper / Mojave Beige lower



Candy White upper / Starlight Blue lower



Candy White upper / Cherry Red lower

¹ Available at extra cost.

Please note: Not all paint and upholstery combinations can be ordered together and in some instances certain combinations may incur extra cost. Not all paint finishes may be available for every trimline. Please check details and availability with your Volkswagen Van Centre at the time of ordering. Screen representations do not allow exact reproduction of paint, upholstery and trim colours.

Paint, upholstery & trim (continued).

Seat upholstery.

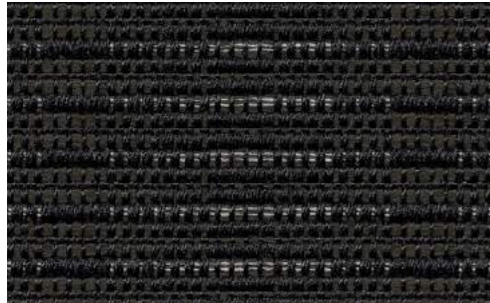

Pandu
Titanium Black Cloth **SE**



Pandu
Moonrock Grey Cloth **SE**



Alcantara¹
Titanium Black **EX**

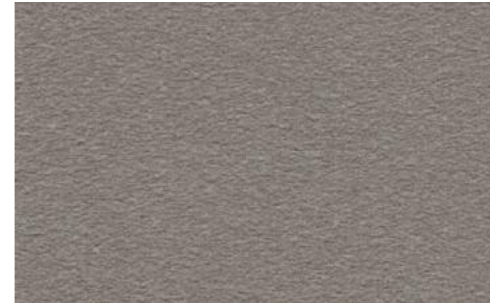

Alcantara¹
Moonrock Grey **EX**



Nappa leather²
Titanium Black **SE** **EX**



Nappa leather²
Moonrock Grey **SE** **EX**

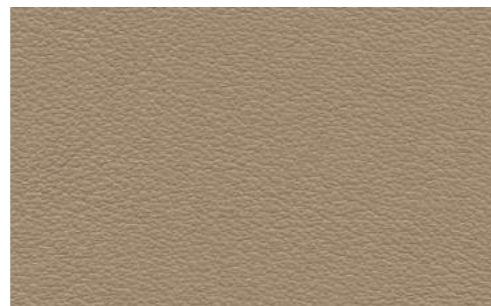

Nappa leather²
Desert Beige **EX**

Interior colours.

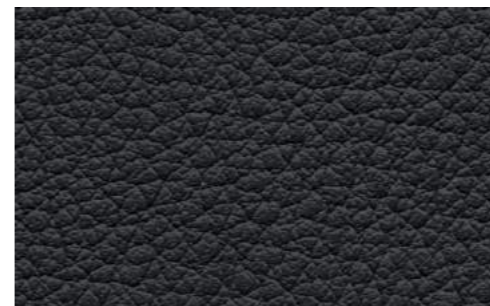

Titanium Black



Moonrock Grey

Decorative inserts and trim.



01 Interior colour 02 Decorative insert
03 Decorative trim



**Piano Black inserts/
Dark Silver brushed trim** **SE**

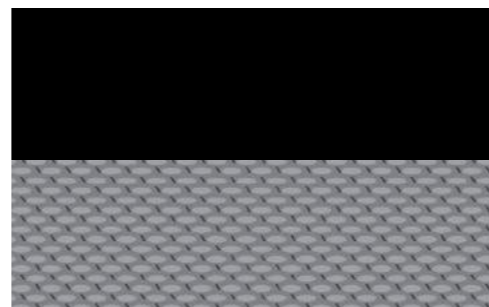

**Black Glossy inserts/
Structural X trim** **EX**



**Piano Black inserts/
Linearus trim** **EX**

1 Standard on Caravelle Executive, available at extra cost on Caravelle SE.
2 Available at extra cost.

Standard Optional
SE | Caravelle SE **EX | Caravelle Executive**

Wheels.

01 16" Clayton. 16 x 6.5J alloy wheels with 215/65 R16 or 205/65 R16 tyres. Standard on Caravelle SE 150PS short wheelbase.

02 17" Devonport. 17 x 7J alloy wheels with 235/55 R17 or 215/65 R17 tyres. Standard on SE 150PS long wheelbase and 199PS engine.

03 17" Cascavel. Black with diamond-turned surface. 17 x 7J alloy wheels with 235/55 R17 or 215/65 R17 tyres.

04 17" Cascavel. Anthracite with diamond-turned surface. 17 x 7J alloy wheels with 235/55 R17 or 215/65 R17 tyres.

05 18" Toluca. Black with diamond-turned surface. 18 x 8J alloy wheels with 255/45 R18 tyres.



SE



SE



EX



SE EX



EX

■ Standard □ Optional
SE | SE EX | Executive

Engine & gearbox data.

Engine specifications.	2.0TDI 150PS	2.0BiTDI 199PS
Engine type	Diesel, transverse, water-cooled, in-line, variable turbine geometry turbocharger with intercooler	Diesel, transverse, water-cooled, in-line, bi-turbo with intercooler
Mixture preparation/injection method	Common-rail, direct injection	Common-rail, direct injection
EU exhaust emission standard	EU6D Temp	EU6D Temp
Number of cylinders	4	4
Cubic capacity	1,968cc	1,968cc
Output, PS at rpm	150 at 3,250-3,750	199 at 3,800-4,000
Torque, max. Nm at rpm	340 at 1,500-3,000	450 at 1,400-2,400
Fuel tank capacity	70 litre	70 litre
AdBlue® capacity	13 litre	13 litre
Diesel Particulate Filter [DPF]	●	●
6-speed manual gearbox	●	-
7-speed dual clutch gearbox [DSG]	○	●
Front-wheel drive	●	●
4MOTION all-wheel drive	-	○
Alternator	180A	180A
Battery	75Ah (420A)	75Ah (420A)

● Standard ○ Available - Not available

Fuel consumption, performance and emissions.

Engine/transmission	CO ₂ emissions, g/km ¹		Combined fuel consumption mpg ¹		Combined fuel consumption (ltr/100km) ¹		Acceleration, seconds 0 - 62mph	Top speed, mph, (where law permits)
	Max.	Min.	Max.	Min.	Max.	Min.		
Caravelle SE short wheelbase.								
2.0TDI 150PS 6-speed manual	189	185	32.1	35.2	8.8	8.0	12.9	113
2.0TDI 150PS 7-speed DSG	177	175	30.4	32.9	9.3	8.6	13.0	112
Caravelle SE long wheelbase.								
2.0TDI 150PS 7-speed DSG	179	175	31.4	32.8	9.0	8.6	13.0	112
2.0BiTDI 199PS 7-speed DSG	189	186	32.8	33.7	8.6	8.4	9.9	124
Caravelle Executive short wheelbase.								
2.0TDI 150PS 6-speed manual	189	185	32.8	34.7	8.6	8.1	12.9	113
2.0TDI 150PS 7-speed DSG	177	171	31.0	33.0	9.1	8.6	13.0	112
2.0BiTDI 199PS 7-speed DSG	188	185	31.7	33.8	8.9	8.4	9.9	124
2.0BiTDI 199PS 4MOTION 7-speed DSG	225	217	28.5	29.6	9.9	9.5	10.1	122

¹ This brochure relates to vehicles tested according to WLTP technical procedures. Figures shown are for comparability purposes; only compare fuel consumption and CO₂ figures with other vehicles tested to the same technical procedures. These figures may not reflect real life driving results, which will depend upon a number of factors including the accessories fitted (post-registration), variations in weather, driving styles and vehicle load. There is a new test used for fuel consumption and CO₂ figures (known as WLTP). The CO₂ figures shown however, are based on a calculation designed to be equivalent to the outgoing (NEDC) test cycle and will be used to calculate vehicle tax on first registration. For more information please visit <https://www.volkswagen-vans.co.uk/en/about-us/wltp.html> or consult your authorised Volkswagen Van Centre.

Data correct at 11.12.2018. Figures quoted are for a range of configurations (including non-UK) and are subject to change due to ongoing approvals/changes.

Weights.

Engine/transmission	Gross vehicle weight, kg	Axle load limit, front/rear, kg	Trailer weight braked 12%/unbraked, kg	Gross train weight, kg	Unladen weight ¹ , kg	Payload ² , kg
Caravelle SE short wheelbase.						
2.0TDI 150PS 6-speed manual	3,000	1,610 / 1,575	2,500 / 750	5,300	2,324	676
2.0TDI 150PS 7-speed DSG	3,000	1,610 / 1,575	2,500 / 750	5,300	2,347	653
Caravelle SE long wheelbase.						
2.0TDI 150PS 7-speed DSG	3,080	1,620 / 1,600	2,500 / 750	5,300	2,414	666
2.0BiTDI 199PS 7-speed DSG	3,080	1,620 / 1,600	2,500 / 750	5,300	2,416	664
Caravelle Executive short wheelbase.						
2.0TDI 150PS 6-speed manual	3,000	1,610 / 1,515	2,500 / 750	5,200	2,370	630
2.0TDI 150PS 7-speed DSG	3,000	1,610 / 1,515	2,500 / 750	5,300	2,389	611
2.0BiTDI 199PS 7-speed DSG	3,080	1,620 / 1,515	2,500 / 750	5,300	2,405	675
2.0BiTDI 199PS 4MOTION 7-speed DSG	3,080	1,620 / 1,515	2,500 / 750	5,300	2,515	565

¹ Unladen weight includes approximately 90% fuel load and 75kg for driver.

² Payload = gross vehicle weight minus unladen weight. Quoted weights are for vehicles with standard specification. Unladen weight and payload may be influenced by trimline, factory options and Van Centre fitted accessories.

Roof load limit: 100kg (with two roof carriers) or 150kg (with at least four roof carriers). Trailer nose weight: 100kg.

Dimensions.

Caravelle SE short and long wheelbase.

		SWB	LWB
Wheelbase		3,000	3,400
Load compartment	length	2,532	2,932
	width	1,627	1,627
	width between wheel arches	1,220	1,220
	height	1,320	1,332
	floor area	4.3m ²	5.0m ²
	load volume	5.8m ³	6.7m ³
Side sliding door	width	1,011	1,011
	height	1,247	1,247
Tailgate	width	1,438	1,438
	height	1,262	1,262
Turning circle (wall to wall)		11.9m	13.2m

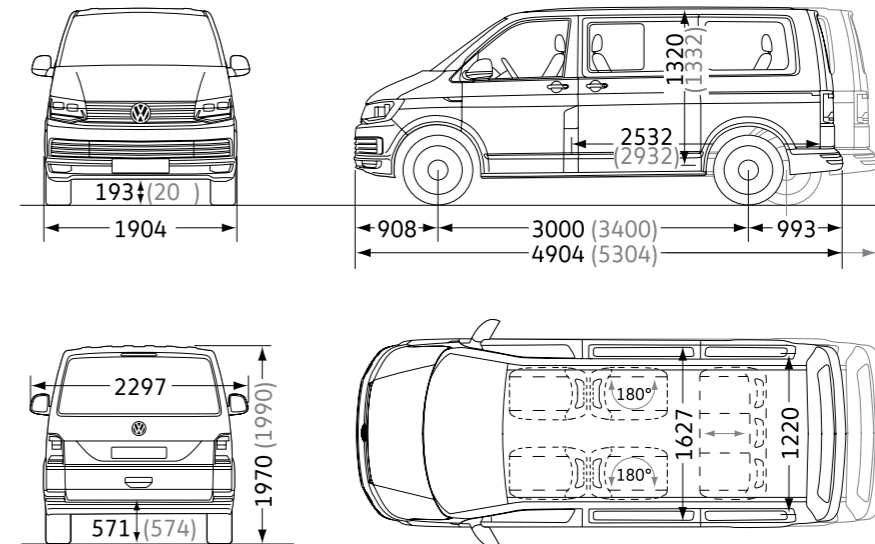

Caravelle Executive short wheelbase.

		SWB
Wheelbase		3,000
Load compartment	length	2,532
	width	1,691
	width between wheel arches	1,220
	height	1,320
	floor area	4.3m ²
	load volume	5.8m ³
Side sliding door	width	1,011
	height	1,247
Tailgate	width	1,438
	height	1,262
Turning circle (wall to wall)		11.9m

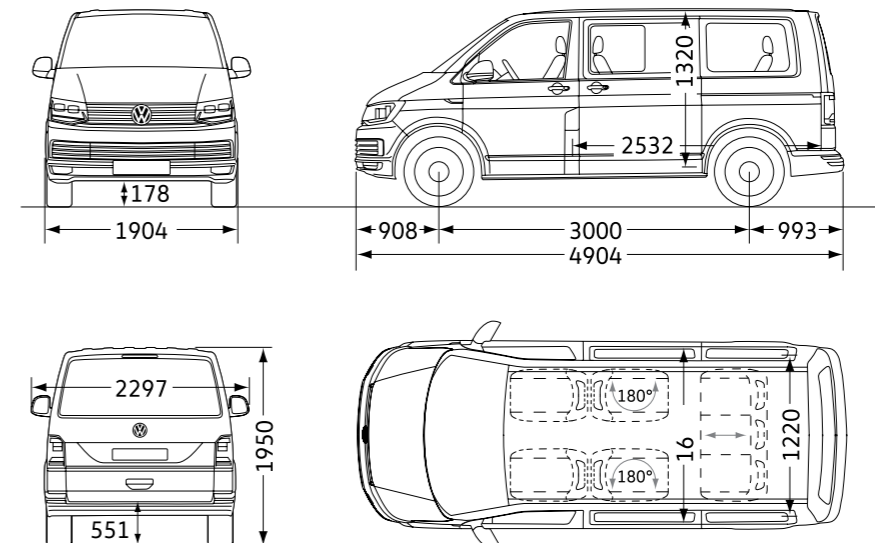

Dimension figures in brackets refer to Caravelle SE LWB.

Please note: Vehicle drawings are not to scale. All dimensions in millimetres (mm), unless otherwise stated. The height measurements listed may vary by ± 50mm depending on model and equipment fitted.

Price list.



***Manufacturer's on the road (OTR) package.**

CO ₂ emissions g/km	171-190	191-225
Delivery to Van Centre	£620.00	£620.00
Number plates	£20.00	£20.00
VAT	£128.00	£128.00
First registration fee	£55.00	£55.00
Vehicle excise duty (VED) 1st year	£1,280.00	£1,815.00
Basic OTR price (exc. VAT)	£1,975.00	£2,510.00
Total OTR price (inc. VAT)	£2,103.00	£2,638.00

Model prices – Caravelle.

Trimline	Engine/transmission	Fuel type	CO ₂ emissions g/km ¹	Basic exc. VAT	Total inc. VAT	Total RRP inc. OTR* exc. VAT	Total RRP inc. OTR* inc. VAT
SE short wheelbase	2.0TDI 150PS 6-speed manual	Diesel	185	£34,150.00	£40,980.00	£36,125.00	£43,083.00
	2.0TDI 150PS 7-speed DSG	Diesel	175	£35,940.00	£43,128.00	£37,915.00	£45,231.00
SE long wheelbase	2.0TDI 150PS 7-speed DSG	Diesel	175	£37,885.00	£45,462.00	£39,860.00	£47,565.00
	2.0TDI 199PS 7-speed DSG	Diesel	186	£40,240.00	£48,288.00	£42,215.00	£50,391.00
Executive short wheelbase	2.0TDI 150PS 6-speed manual	Diesel	185	£37,525.00	£45,030.00	£39,500.00	£47,133.00
	2.0TDI 150PS 7-speed DSG	Diesel	171	£39,315.00	£47,178.00	£41,290.00	£49,281.00
	2.0TDI 199PS 7-speed DSG	Diesel	185	£41,670.00	£50,004.00	£43,645.00	£52,107.00
	2.0TDI 199PS 4MOTION 7-speed DSG	Diesel	217	£44,205.00	£53,046.00	£46,715.00	£55,684.00

* Please click here for more details on manufacturer's on the road (OTR) package.

Volkswagen Commercial Vehicles may change RRP's at any time (this includes where there are government changes in regulation and/or legislation). There may be a delay to any RRP displaying correctly on our materials. Always obtain prices from your chosen authorised Van Centre.

1 This brochure relates to vehicles tested according to WLTP technical procedures. Figures shown are for comparability purposes; only compare fuel consumption and CO₂ figures with other vehicles tested to the same technical procedures. These figures may not reflect real life driving results, which will depend upon a number of factors including the accessories fitted (post-registration), variations in weather, driving styles and vehicle load. There is a new test used for fuel consumption and CO₂ figures (known as WLTP). The CO₂ figures shown however, are based on a calculation designed to be equivalent to the outgoing (NEDC) test cycle and will be used to calculate vehicle tax on first registration. For more information please visit <https://www.volkswagen-vans.co.uk/en/about-us/wltp.html> or consult your authorised Volkswagen Van Centre. The CO₂ figures are reflective of the standard specification. Adding options, such as different wheels or tyres may affect the final CO₂ figures. For further information please see page 20 to view the full range of CO₂ emissions, or consult your authorised Volkswagen Van Centre.

Data correct at 11.12.2018. Figures quoted are for a range of configurations (including non-UK) and are subject to change due to ongoing approvals/changes.

Options – Caravelle.

Paint.	PR Code.	SE.		Executive.	
		Basic exc. VAT	Total RRP inc. VAT	Basic exc. VAT	Total RRP inc. VAT
Solid. Candy White (B4B4), Cherry Red (4B4B).	As shown	○	○	○	○
Metallic. Acapulco Blue (2W2W), Bamboo Garden Green (3T3T), Chestnut Brown (H4H4), Indium Grey (X3X3), Mojave Beige (1B1B), Reflex Silver (8E8E), Starlight Blue (3S3S).	As shown	£590.00	£708.00	£590.00	£708.00
Pearl effect. Deep Black (2T2T).	As shown	£590.00	£708.00	£590.00	£708.00
Mother-of-pearl. Oryx White (0R0R).	As shown	£995.00	£1,194.00	£995.00	£1,194.00
Two-tone paint, upper/lower. Candy White/Bamboo Garden Green (9691), Candy White/Indium Grey (9916), Candy White/Mojave Beige (9198), Candy White/Starlight Blue (9915), Candy White/Cherry Red (9335), Indium Grey/Deep Black Pearl (9077).	As shown	£2,170.00	£2,604.00	£2,170.00	£2,604.00

Upholstery.

Seat trim covers in Alcantara®. Moonrock Grey. Dashboard upper in Titanium Black, dashboard lower in Moonrock Grey, floor covering in Moonrock Grey. Not available on long wheelbase or Executive models. Titanium Black. Dashboard upper in Titanium Black, dashboard lower in Titanium Black, floor covering in Titanium Black.	N7N	-	-	●	●
Seat trim covers in Nappa leather. Moonrock Grey. Dashboard upper in Titanium Black, dashboard lower in Moonrock Grey, floor covering in Moonrock Grey. Not available on long wheelbase or Executive models. Titanium Black. Dashboard upper in Titanium Black, dashboard lower in Titanium Black, floor covering in Titanium Black.	N1A	£2,090.00	£2,508.00	£1,080.00	£1,296.00
Seat trim covers in Nappa leather. Desert Beige. Dashboard upper in Titanium Black, dashboard lower in Titanium Black, floor covering in Titanium Black, headliner in Desert Beige.	N1A	-	-	£1,080.00	£1,296.00
Seat trim covers in Pandu fabric. Moonrock Grey. Dashboard upper in Titanium Black, dashboard lower in Moonrock Grey, floor covering in Moonrock Grey. Standard on short wheelbase models. Titanium Black. Dashboard upper in Titanium Black, dashboard lower in Titanium Black, floor covering in Titanium Black. Standard on long wheelbase models.	NOL	●	●	-	-

● Standard – Not available ○ At no extra cost Where additional equipment is required by chosen options, additional equipment will be charged at the prices shown.

Volkswagen Commercial Vehicles may change RRP's at any time (this includes where there are government changes in regulation and/or legislation). There may be a delay to any RRP displaying correctly on our materials. Always obtain prices from your chosen authorised Van Centre.

Options – Caravelle (continued).

Decorative inserts and trim.	PR Code.	SE.		Executive.	
		Basic exc. VAT	Total RRP inc. VAT	Basic exc. VAT	Total RRP inc. VAT
Dark Silver brushed decorative trim with metallic Anthracite decorative insert.	5MB	●	●	–	–
Linearus decorative trim with gloss Black decorative insert.	5MQ	–	–	£70.00	£84.00
Linearus decorative trim with metallic Anthracite decorative insert.	5ML	£70.00	£84.00	–	–
Structural X decorative trim with Piano Black decorative insert.	5MT	–	–	●	●
Seating.					
2 individual seats with longitudinal adjustment on rail system in 3rd row. SWB only.	ZJ7	○	○	○	○
2 integrated child seats for swivel seats in 2nd row.	QA6	£315.00	£378.00	£315.00	£378.00
2 swivel seat with longitudinal adjustment on rail system in 2nd row.	4C2	●	●	●	●
3-seater movable bench with reclining action and storage tray in 3rd row.	3VX	●	●	●	●
Armrest for driver and single front passenger seats.	4S1	●	●	●	●
Front seat pack. Includes heated driver and single front passenger seats, powered lumbar support for driver seat, manual lumbar support for single front driver seat, 12-way powered driver seat with memory function, manual height-adjustment for single front passenger seat.	ZNP	–	–	£595.00	£714.00
Heated driver and single front passenger seats.	4A3	£275.00	£330.00	●	●
Height adjustment for driver and single passenger seats (manual).	3L3	●	●	●	●
ISOFIX and top tether child seat anchorage in 2nd to 4th rows.	3B3	●	●	●	●
Lumbar support for driver and single front passenger seats, manual.	7P4	●	●	●	●
Premium front seat pack. Includes heated driver and single front passenger seats, powered lumbar support for driver and single front passenger seats, 12-way powered driver and single front passenger seats with driver seat memory function.	ZNN	£1,315.00	£1,578.00	£1,030.00	£1,236.00

● Standard – Not available ○ At no extra cost Where additional equipment is required by chosen options, additional equipment will be charged at the prices shown.

Volkswagen Commercial Vehicles may change RRP's at any time (this includes where there are government changes in regulation and/or legislation). There may be a delay to any RRP displaying correctly on our materials. Always obtain prices from your chosen authorised Van Centre.

Options – Caravelle (continued).

	PR Code.	SE.		Executive.	
		Basic exc. VAT	Total RRP inc. VAT	Basic exc. VAT	Total RRP inc. VAT
Wheels and tyres.					
16" Clayton alloy wheels. 6.5J x 16. Not available for SE 199PS.	V21	●	●	-	-
17" Cascavel alloy wheels, Anthracite diamond-turned surface. 7J x 17.	Z3N	£860.00	£1,032.00	£295.00	£354.00
	SE 199PS Z3N	£295.00	£354.00	-	-
17" Cascavel alloy wheels, Black diamond-turned surface. 7J x 17.	Z3Z	-	-	●	●
17" Devonport alloy wheels. 7J x 17. LWB only.	Z3F	●	●	-	-
18" Toluca alloy wheels. 8J x 18. Comes with tyre mobility kit in lieu of spare wheel, 12V compressor, tyre sealant and tool kit.	Z3B	-	-	£1,435.00	£1,722.00
All-weather tyres. Please contact your local Van Centre for availability.	Q31/33/34	From £130.00	From £156.00	From £130.00	From £156.00

Wheel and tyre accessories.

Alloy spare wheel with original equipment tyre.	1G3	-	-	●	●
Steel spare wheel with original equipment tyre.	1G2	●	●	-	-
Tool kit and jack.	1S1	●	●	●	●
Tyre mobility kit in lieu of spare wheel. Includes 12V compressor and tyre sealant.	1G8	○	○	○	○

● Standard – Not available ○ At no extra cost Where additional equipment is required by chosen options, additional equipment will be charged at the prices shown.

Volkswagen Commercial Vehicles may change RRP's at any time (this includes where there are government changes in regulation and/or legislation). There may be a delay to any RRP displaying correctly on our materials. Always obtain prices from your chosen authorised Van Centre.

Options – Caravelle (continued).

	PR Code.	SE.		Executive.	
		Basic exc. VAT	Total RRP inc. VAT	Basic exc. VAT	Total RRP inc. VAT
Audio and communications.					
App-Connect. Only in combination with Composition Media DAB+ radio system or Discover Media navigation system plus at an additional cost.	9WT	£145.00	£174.00	£145.00	£174.00
Bluetooth® hands-free set.	9ZX	●	●	●	●
Composition Colour DAB+ radio system with 5" touch-screen.	l6V	●	●	●	●
Composition Media DAB+ radio system with 6.33" touch-screen.	Zl6	£165.00	£198.00	£165.00	£198.00
Dynaudio Digital sound pack. Includes 4 tweeters, 3 mid-frequency speakers, 4 woofers, 11 channel amplifier.	9VE	–	–	£1,375.00	£1,650.00
Discover Media navigation system plus. Includes Digital Voice Enhancement (DVE), Volkswagen Media Control and App-Connect.	Zl8	£1,255.00	£1,506.00	£1,255.00	£1,506.00
Multi-function display plus.	9Q5	●	●	–	–
Multi-function display Premium with multi-colour display.	9Q4	–	–	●	●
Comfort and convenience.					
Electric sliding sunroof in cab with sunblind.	3JB	£580.00	£696.00	£580.00	£696.00
Headlight washer system with heated front washer nozzles and washer fluid level indicator.	8X1	£175.00	£210.00	£165.00	£198.00
Multi-function table with separate guide rails in the floor.	1U3	●	●	●	●
Driver assistance.					
Adaptive Cruise Control (ACC) including Front Assist with City Emergency Braking System (maximum speed 99mph where law permits). Only in combination with leather multi-function steering wheel at an additional cost.	PAD	£710.00	£852.00	£545.00	£654.00
Cruise control.	8T2	£210.00	£252.00	●	●
Front Assist with City Emergency Braking, without Adaptive Cruise Control (ACC).	6K2	●	●	●	●
High Beam Assist. On SE models only in combination with Lights & Vision pack at an additional cost.	8G1	£130.00	£156.00	£130.00	£156.00

● Standard – Not available ○ At no extra cost Where additional equipment is required by chosen options, additional equipment will be charged at the prices shown.

Volkswagen Commercial Vehicles may change RRP's at any time (this includes where there are government changes in regulation and/or legislation). There may be a delay to any RRP displaying correctly on our materials. Always obtain prices from your chosen authorised Van Centre.

Options – Caravelle (continued).

Driver assistance (continued).	PR Code.	SE.		Executive.	
		Basic exc. VAT	Total RRP inc. VAT	Basic exc. VAT	Total RRP inc. VAT
Leather multi-function steering wheel and gearknob with radio and telephone controls.	ZE7	£320.00	£384.00	●	●
Leather multi-function sports steering wheel and gearknob with radio, telephone and display controls. DSG only.	ZEA	£345.00	£414.00	£115.00	£138.00
Side scan with cruise control. SWB only.	Z1Y	£505.00	£606.00	£315.00	£378.00
Parking sensors, front and rear.	7X2	£425.00	£510.00	£425.00	£510.00
Parking sensors, front and rear with rear-view camera.	7X8	£595.00	£714.00	£595.00	£714.00

Packages.

Chrome pack. Includes front fog lights with cornering lights, grille with chrome mouldings and chrome clamp.	ZL6	-	-	●	●
Good night pack. Includes window blinds, bed covering, three shelves under 3-seater bench, mini flashlight and waste bin.	ZQ2	£335.00	£402.00	£335.00	£402.00
LED headlights with LED daytime running lights and LED tail lights. Only in combination with Headlight washer system with heated front washer nozzles and washer fluid level indicator at an additional cost.	PXE	£1,375.00	£1,650.00	£1,375.00	£1,650.00
Lights & Vision pack. Includes automatic headlights with separate daytime running lights, leaving home and manual coming home function, break-away auto-dimming rear-view interior mirror and windscreen wiper with intermittent control with rain sensors.	Z4A	£230.00	£276.00	●	●
Non-smoker's pack. 12V socket and cup holder in dashboard.	9JA	●	●	●	●

Body and chassis.

Electric tailgate without interior release. Only in combination with front and rear parking sensors or front and rear parking sensors with rear-view camera at an additional cost.	ZEH	£525.00	£630.00	£525.00	£630.00
Dynamic suspension. Body lowered by 20mm.	2MH	-	-	●	●
Electric sliding door driver and passenger side. Only in combination with 4 remote control folding keys at an additional cost.	PT4	£785.00	£942.00	●	●
Mounting rails on the roof. Preparation for movable roof rack.	3S4	£110.00	£132.00	£110.00	£132.00

● Standard – Not available ○ At no extra cost Where additional equipment is required by chosen options, additional equipment will be charged at the prices shown.

Volkswagen Commercial Vehicles may change RRP's at any time (this includes where there are government changes in regulation and/or legislation). There may be a delay to any RRP displaying correctly on our materials. Always obtain prices from your chosen authorised Van Centre.

Options – Caravelle (continued).

Body and chassis (continued).	PR Code.	SE.		Executive.	
		Basic exc. VAT	Total RRP inc. VAT	Basic exc. VAT	Total RRP inc. VAT
Mudflaps, front and rear.	6N2	£125.00	£150.00	£125.00	£150.00
Suspension and shock absorbers, heavy-duty. Vehicle height increases 20mm on short wheelbase.	1BJ	£210.00	£252.00	£210.00	£252.00
Towbar preparation. Includes trailer stabilisation.	1D7	£205.00	£246.00	£205.00	£246.00
Towbar, removable/lockable. Includes trailer stabilisation.	1D2	£560.00	£672.00	£560.00	£672.00
Wing mirrors, heated, power adjustable, power folding.	6XP	£120.00	£144.00	£120.00	£144.00
Cargo.					
Cooling/warming box, 32 litre. Including second battery with cut-off relay, maintenance-free.	ZK7	£420.00	£504.00	£420.00	£504.00
Electrical.					
Electrical interface and multi-function control module for external use.	IS2	£325.00	£390.00	£325.00	£390.00
Heating and ventilation.					
Climatic semi-automatic air conditioning for cab with 2nd heating system and ventilation in passenger compartment.	KH2	●	●	–	–
Climatronic 3-zone air conditioning with 2nd evaporator, auxiliary heater, air conditioned headliner and additional passenger control.	ZZ9	£895.00	£1,074.00	●	●
Dust and pollen filter.	2V1	●	●	●	●

● Standard – Not available ○ At no extra cost Where additional equipment is required by chosen options, additional equipment will be charged at the prices shown.

Volkswagen Commercial Vehicles may change RRP's at any time (this includes where there are government changes in regulation and/or legislation). There may be a delay to any RRP displaying correctly on our materials. Always obtain prices from your chosen authorised Van Centre.

Options – Caravelle (continued).

	PR Code.	SE.		Executive.	
		Basic exc. VAT	Total RRP inc. VAT	Basic exc. VAT	Total RRP inc. VAT
Heating and ventilation (continued).					
Programmable parking heater (air) with radio remote control, auxiliary heater (coolant-based) and second battery. Provides an auxiliary heater combined with a supplementary air heater. The two heaters heat the vehicle when parked and support the engine to heat the vehicle when cold. The supplementary heater is controlled via the remote control, or the operating unit in the roof, which has settings for switch-on time, day of the week and desired temperature. Includes second battery.	PW5	£1,915.00	£2,298.00	£1,915.00	£2,298.00
Safety and security.					
Airbags, side and curtain, for driver and front passenger.	4X3	●	●	●	●
Airbags, curtain airbags in rear passenger compartment.	4X7	£305.00	£366.00	£305.00	£366.00
First aid kit, warning triangle and hi-vis vest.	1T9	£50.00	£60.00	£50.00	£60.00
Four remote control folding keys.	8QM	£85.00	£102.00	●	●
Windows.					
Laminated glass pack with improved outside noise insulation. Only in combination with Lights & Vision pack on SE at an additional cost. Specifying this option removes the Laminated windscreen, heated on Executive.	Z2A	£585.00	£702.00	£385.00	£462.00
Laminated windscreen, heated. Only in combination with Lights & Vision pack on SE at an additional cost.	4GR	£375.00	£450.00	●	●
Privacy glass in passenger compartment with heat insulating glass (Green) in cab.	QL5	£260.00	£312.00	●	●
Side windows, sliding front and fixed rear in passenger compartment on driver side.	4JN	£180.00	£216.00	£180.00	£216.00
Side windows, sliding front and fixed rear in passenger compartment on passenger side.	4FN	£180.00	£216.00	£180.00	£216.00

● Standard – Not available ○ At no extra cost Where additional equipment is required by chosen options, additional equipment will be charged at the prices shown.

Volkswagen Commercial Vehicles may change RRP's at any time (this includes where there are government changes in regulation and/or legislation). There may be a delay to any RRP displaying correctly on our materials. Always obtain prices from your chosen authorised Van Centre.

Finance made simple.

As dedicated to finance as we are to your new Caravelle.

Learn more about our range of finance products to find a finance package that suits your budget.

Alternatively, 'Click on' the Offers & Finance button above to find out more about our latest offers to help your business thrive.

Cost of your vehicle

Deposit
As little as one monthly repayment

Monthly repayments
Spread across 18 to 49 months

Optional final payment
You have three choices at the end of your agreement



Own Hire

Cost of your vehicle

Deposit
As little as one monthly repayment

Repayments
Spread across 12 to 60 months



Own

Cost of your vehicle

Deposit
As little as one monthly repayment

Rental repayments
Spread across 12 to 48 months

Final 'balloon' repayment



Own

Solutions Personal Contract Plan

Not sure if you want to own or hire? Make the decision later.

Pay monthly payments for the length of your agreement. At the end you can decide to keep (once all payments have been made), upgrade or return the vehicle.

Hire Purchase

Make all the regular monthly payments. At the end the vehicles is yours.

Lease Purchase

Make lower monthly payments by deferring an amount until the end. Once paid the vehicle is yours.

Cost of your vehicle

Initial rental
As little as one rental repayment

Rental repayments
Spread across 12 to 60 months



Hire

Cost of your vehicle

Initial rental
As little as one rental repayment in advance

Rental repayments
Spread across 12 to 60 months



Hire

Cost of your vehicle

Initial rental
As little as one rental repayment in advance

Rental repayments
Spread across 12 to 48 months

Final 'balloon' repayment
You have two options at the end of your agreement



Hire

Contract Hire

Pay fixed monthly rentals to hire the vehicle. Look after it so at the end you can return it hassle free.

Finance Lease (full pay out)

Pay monthly rentals to hire the vehicle. At the end you have two options. Sell the vehicle and receive a percentage of the sale proceeds. Or retain the use of your vehicle by paying a reduced annual rental.

Finance Lease (balloon repayment)

Pay monthly rentals to hire the vehicle. At the end you have two options. Sell the vehicle to settle the outstanding amount and receive any excess sale proceeds. Or pay the 'balloon' payment and retain the use of your vehicle by paying a reduced annual rental.

Finance subject to status. Available to 18s and over in the UK only. Terms and Conditions apply. Volkswagen Commercial Vehicle Financial Services.

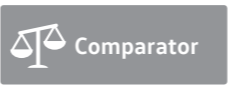
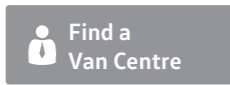
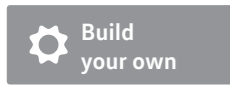

Service & warranties.

Finance and insurance.¹

When it comes to paying for your vehicle, we've got options including Contract Hire and Finance Lease, or Hire Purchase. We can also offer you competitive insurance.

A choice of packages.²

Whether you prefer to lease your vehicles, with none of the concerns of ownership and the freedom to change models easily, or purchase outright to own the vehicle that's perfect for your business, we're here to help you consider your options.

You can go flexible, by choosing a payment plan that suits your finances, with options to reduce your monthly costs and your repayment period. Or choose a fixed monthly price that allows you to budget confidently for the longer term.

You can even include your road tax and servicing costs to arrive at one simple, all-inclusive payment. For more information, pick up a finance brochure, or ask at your Van Centre.

Volkswagen insurance.

Volkswagen Commercial Vehicles Insurance³ provides cost-effective and comprehensive motor insurance³, as well as gap insurance⁴, which helps replace your vehicle and protect you from any financial shortfall if it's written off.

Insurance benefits include:

- Complimentary 5-day drive away insurance cover.
- All repairs performed by approved repairers.
- Volkswagen Genuine Parts[®] used on all repairs.
- Courtesy vehicle provided during repair following an accident (subject to availability).
- Cover for breakage and damage to glass.
- In-vehicle personal belongings cover (up to £250).
- Vehicle recovery.
- 90-day European Union cover.

For more information about our motor insurance call: **0345 877 6355** (lines open 9am-6pm Monday-Friday) or visit: insurewithvwcv.co.uk

Servicing and support.

We're here to keep your business moving, with our range of three award-winning⁵ servicing and maintenance options, as well as free Roadside Assistance. Some exclusions apply. For more detail, please visit www.volkswagen-vans.co.uk/aftersales.

Pay monthly.

This option is available for vehicles that are less than 12 months old and have covered less than 10,000 miles. It makes budgeting easier by splitting the cost of servicing into fixed monthly payments – whether you want Service only; Service and Maintenance; or Service, Maintenance and Tyres.

Pay upfront.⁶

If you can pay for more than one service upfront, we'll help by reducing your costs. Buy two upfront and you'll receive one interim and one full service at a discounted rate. Buy four and you'll receive two interim and two full services, with your next MOT also included.

Pay on demand.

If you're looking for freedom and flexibility with your servicing, it's good to know we're ready when you are. So with our third option, you can choose to pay for your services as and when you need them, with our National Service Pricing. Ask your Van Centre for an up-to-date pricing guide.

Roadside Assistance.

We understand the need to keep you mobile. That's why all new vans come with three-year, unlimited mileage roadside cover. Should the unexpected happen, one call gets you straight through to a team trained to help you through any breakdown or accident. Supporting you every day will be a team of vehicle technicians, fully-trained by Volkswagen and carrying the latest diagnostic equipment, specialist tools and parts.

Assistance benefits include:

- Assistance at home, by the roadside or place of work.
- Recovery to your preferred location.
- Onward travel, for you and your cargo.
- Cover 24 hours a day, 365 days a year.
- Free cover for three years (on new vehicles).
- Unlimited mileage.
- European cover.
- Option to extend cover beyond three years.

Warranties.

You can count on us long after you purchase your Caravelle, thanks to its comprehensive three-year, 100,000 mile warranty. You choose Volkswagen because your business depends on it, year in, year out. While your Caravelle is under warranty, we'll fix any defect in manufacture or workmanship free of charge, even if you purchase and service the vehicle at different Van Centres. Some exclusions apply and the vehicle must be cared for using the guidance in your owner's manual. For more detail, please visit www.volkswagen-vans.co.uk/aftersales.

Extended warranty.

You can also extend your warranty beyond the three-year, 100,000 mile period, choosing either Comprehensive or Major Component cover, as a one-off or monthly payment. For more detail of cover levels, along with terms and conditions, please visit volkswagencvwarranty.co.uk where you'll also be able to obtain a quote and purchase an extended warranty.

Paint and body warranty.

Your Caravelle's exterior paintwork is covered against manufacturing defects for a period of three years, while its body sections and panels are covered against rusting through from the inside for 12 years. Some exclusions apply and the vehicle must be cared for using the guidance in your owner's manual.

The Van Centre network.

Our **dedicated Van Centre network** is at the core of everything we do and is always there to help. As a separate brand within the Volkswagen Group, it makes sense to make use of your nearest Van Centre – it's full of experts who understand your vehicle better than anyone else and can help you to get the most out of it.

Over **70 Van Centres** and **24 Authorised Repairers**, means you're only around 45 minutes on average from our door.

1 Volkswagen Commercial Vehicles Insurance and Volkswagen Commercial Vehicle Financial Services are trading names of Volkswagen Financial Services (UK) Limited, Brunswick Court, Yeomans Drive, Blakelands, Milton Keynes MK14 5LR, which is authorised and regulated by the Financial Conduct Authority (FCA). Registered in England and Wales No. 2835230. Volkswagen Financial Services (UK) Limited financial services register number is 311988.

2 An offer of finance depends on certain conditions. Finance subject to status. Available to 18s and over. Terms and conditions apply. Volkswagen Commercial Vehicle Financial Services.

3 Volkswagen Commercial Vehicle Insurance is arranged by U K Insurance Business Solutions Limited and is underwritten by U K Insurance Limited. U K Insurance Business Solutions Limited is authorised and regulated by the Financial Conduct Authority and U K Insurance Limited is authorised by the Prudential Regulation Authority and regulated by the Financial Conduct Authority and the Prudential Regulation Authority. U K Insurance Business Solutions Limited. Registered office: Churchill Court, Westmoreland Road, Bromley, Kent BR1 1DP. Registered in England and Wales No. 05196274. Calls may be recorded.

4 Volkswagen Commercial Vehicle Insurance gap insurance is underwritten by MAPFRE Asistencia Compañía Internacional de Seguros y Reaseguros Sociedad Anonima authorised by Dirección General de Seguros y Fondos de Pensiones and subject to limited regulation by the Financial Conduct Authority and Prudential Regulation Authority, number 203041. Details about the extent of their regulation by the Financial Conduct Authority and Prudential Regulation Authority are available on request. MAPFRE Asistencia Compañía Internacional de Seguros y Reaseguros Sociedad Anonima is incorporated and registered in the Kingdom of Spain and registered as a foreign company in the United Kingdom with company number FC021974, acting through its UK branch with branch number BR008042 and whose principal office is at Alpha House, 5th Floor, 24A Lime Street, London EC3M 7HS. Volkswagen Commercial Vehicle Insurance gap insurance is administered by Abraxas Insurance Administration Services Limited, who is authorised and regulated by the Financial Conduct Authority with FCA number 308702 and who acts on behalf of the Insurer. Abraxas Insurance Administration Services Limited is registered in England and Wales with company number: 02928787 and whose registered office is at One Glass Wharf, Bristol BS2 0SX. Volkswagen Financial Services (UK) Limited is authorised and regulated by the Financial Conduct Authority (FCA). Authorisation details can be checked on the Financial Services register at www.fca.org.uk/firms/systems-reporting/register or call 0800 111 6768. Volkswagen Financial Services (UK) Limited is not part of the same corporate group as MAPFRE Asistencia Compañía Internacional de Seguros y Reaseguros Sociedad Anonima and Abraxas Insurance Administration Service Limited.

5 Business Vans Awards 2014 and 2015: Best Service Package for Van Owners.

6 Class 4 MOT only. This option is available to all new and used vehicles up to four years old or with less than 80,000 miles on the clock. Services must be used consecutively prior to vehicle reaching eight years old.

Design	Comfort & flexibility	Infotainment systems	Mobile online services	Assistance systems	4MOTION all-wheel drive	Caravelle SE	Caravelle Executive	Paint, upholstery & trim	Wheels	Technical information	Price list	Offers & finance	Service & warranties
--------	-----------------------	----------------------	------------------------	--------------------	-------------------------	--------------	---------------------	--------------------------	--------	-----------------------	------------	------------------	----------------------



Build
your own



Find a
Van Centre



Test drive



Offers &
Finance



Conversions



Comparator



The Caravelle

This brochure supersedes all previous publications.

Issue: 8 May 2019

www.volkswagen-vans.co.uk

Please note: Screen technology does not allow exact reproduction of the paint and upholstery colours. Some of the vehicles shown are European specification and may be fitted with optional equipment or accessories that are available at extra cost, or do not reflect current specification. All data and specifications are in accordance with information available at the time of publication and are subject to change without notice. Vehicles not currently in UK stock and customer order vehicles may take a number of weeks for delivery. Certain combinations of vehicle specifications and factory-fitted options are not compatible and therefore all orders received are subject to confirmation. Models, factory fitted-options and paint and upholstery options are subject to availability. Please check details and availability with an authorised Volkswagen Van Centre at the time of ordering.