

The Amarok Brochure



WHATCAR?
CAR
OF THE
YEAR
2019
Pick-up
Winner



Commercial
Vehicles

The Amarok

100% pickup. 100% premium

V6

Perfect for off-road.

Permanent 4MOTION all-wheel drive.

Optimised safety.

Automatic Post-Collision Braking System utilising 17 inch disc brakes in the front and 16 inch disc brakes at rear.

Load platform surface usage.

Widest load platform in its class and moving tailgate.

Towing capacity and payload.

Towing load of up to 3.1 tonnes and 1,146 kilogrammes payload.¹

Exterior design.

Styling bar plus² and up to 20 inch alloy wheels.

Interior design.

Intuitive controls and the only vehicle with 'ergoComfort' seats with 14-way adjustment.³

Modern infotainment systems.

Radio and navigation systems with Car-Net mobile online services.

V6 3.0 litre TDI engines.

With a power output of up to 258PS and torque of up to 580 Nm.

Improved transmission.

Permanent 4MOTION all-wheel drive with eight-speed automatic gearbox.

Fuel-saving technology.

Including start/stop system.



1 Amarok Trendline 3.0 litre V6 TDI 204PS engine, Permanent 4MOTION all-wheel drive with eight-speed automatic transmission.
2 Optional at extra cost.
3 Optional on Amarok Highline models.

Please contact your local Volkswagen Commercial Vehicles Van Centre for details of the standard equipment and optional extras available.

Contents

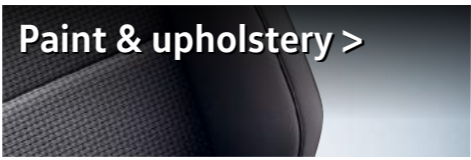
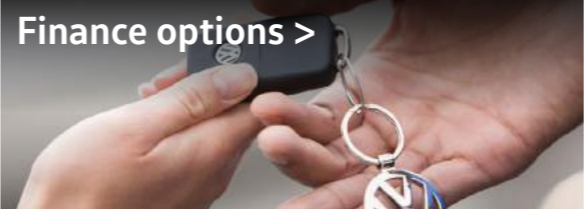
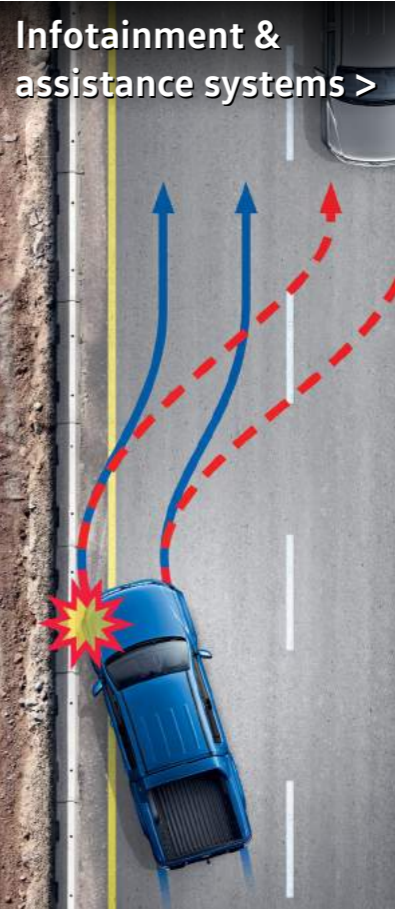
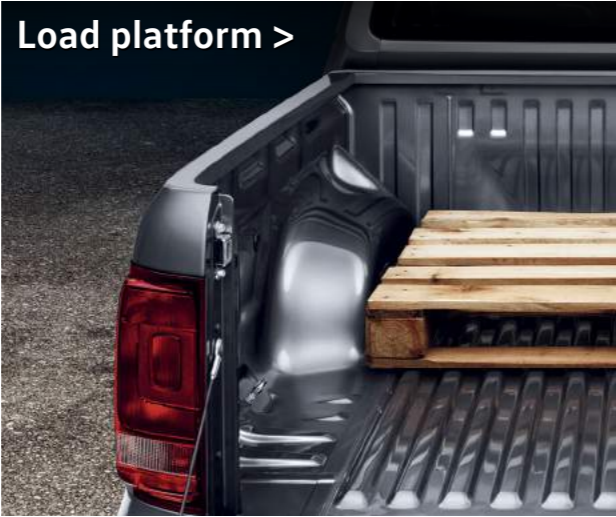

More dynamic

Clear lines and bi-xenon headlights

The Amarok is eye-catching from any angle, with its wide stance and rugged appearance combined with powerful engines, strong chassis and superb interior styling. The chiselled contours and styling highlights exude quality and style, beautifully complemented by the striking rear design, making it as much at home for the family as it is at work.



Please contact your local Volkswagen Commercial Vehicles Van Centre for details of the standard equipment and optional extras available.



More exclusive

Stylish cockpit with premium equipment, intuitive infotainment systems and Car-Net mobile online services

The interior provides a convincing combination of space, high comfort and numerous extras. All Amarok models feature as standard, a dash panel with decorative trim, A4 format storage compartment and a leather trimmed multifunction steering wheel. Depending on your choice of model, the Amarok also includes either the Composition Media DAB+ radio system or the Discover Media navigation system.



'App-Connect' is available in conjunction with the Composition Media radio system or the Discover Media navigation systems. 'App-Connect' comprises MirrorLink™, CarPlay™ and Android Auto™. The availability of these technologies may vary depending on the country in question. Please note that 'App-Connect' is not currently supported by every mobile telephone on the market. Volkswagen is working closely with major smartphone producers to promote broader compatibility for 'App-Connect'.



Please contact your local Volkswagen Commercial Vehicles Van Centre for details of the standard equipment and optional extras available.

More reassuring

Equipped with the Automatic Post-Collision Braking System and electronic trailer stabilisation system as standard

Safety on almost any terrain: The Amarok is the only pick-up in its class to come with an Automatic Post-Collision Braking System as standard. What's more, the Amarok also features 17 inch brake discs at the front and 16 inch brake discs in the rear. Add to that, the trailer stabilisation system which provides the best possible protection against snaking trailers, and it all provides even further peace of mind.

For more information please refer to the Infotainment & assistance systems section.



More powerful

4MOTION all-wheel drive, off-road ABS and Hill Descent Assist

The Amarok offers premium driving comfort, even under the toughest of conditions. This is due to the perfect harmony created between the running gear and drive train – combined with the proven and tested 4MOTION all-wheel drive which knows how to pack a punch when it needs to. The outstanding off-road ABS function also helps to reduce braking distances on loose terrain.

The Amarok is the only pickup in its class to offer drivers the luxury of combining the Permanent 4MOTION all-wheel drive with an eight-speed automatic gearbox. The automatic gear-change system increases driving comfort considerably, particularly on challenging terrain or in hilly regions.



Please contact your local Volkswagen Commercial Vehicles Van Centre for details of the standard equipment and optional extras available.

Off-road performance

Ready for the challenge

The Amarok's innovative Permanent 4MOTION all-wheel drive system enables sure-footed progress when you encounter rain, snow, sand, mud or gravel. It's designed to maintain traction while off-road, as well as offering improved road holding and increased safety in poor surface conditions.



01 Permanent 4MOTION all-wheel drive (not shown). This 4x4 drive system with a self-locking Torsen central differential is unique in the pickup segment and provides a balanced 40:60 distribution for all on-road and off-road tasks.¹ This vehicle also comes into its own on the road by significantly increasing traction when cornering.

Mechanical differential lock (not shown). The Amarok is also available with an optional mechanical differential lock which helps provide ideal traction on sandy and slippery terrain. Following activation, both of the rear wheels are powered with even power and even speed.

Hill Hold Assist (not shown). This prevents the vehicle from rolling back on inclines and simplifies hill starts.

¹ The distribution varies depending on the surface.

Please contact your local Volkswagen Commercial Vehicles Van Centre for details of the standard equipment and optional extras available.

01

| | | | | | | | | | | | | | | |
|----------|--------------------|----------------|-----------------------------|---------------------------|---------------|-----------------|--------------------|----------------------------------|-----------------------------------|------------------------|-----------------------|------------|-----------------|--|
| Exterior | Interior & comfort | Safety systems | Off-road performance | Towing capacity & payload | Load platform | Equipment lines | Paint & upholstery | Alloy wheels, interior & comfort | Infotainment & assistance systems | Mobile online services | Technical information | Price list | Finance options | Finance, insurance, servicing & warranties |
|----------|--------------------|----------------|-----------------------------|---------------------------|---------------|-----------------|--------------------|----------------------------------|-----------------------------------|------------------------|-----------------------|------------|-----------------|--|



Outstanding off-road ABS with Hill Descent Assist.

02 Brakeover angle. Thanks to increased ground clearance and depending on the loading condition, the Amarok can climb ramps with an angle from 15.6° up to 20.1°.¹

04 Ramp angle and wading depth. The maximum angles of approach and departure for the Amarok is 29.5° at the front and 18.0° at the rear. It also has a wading depth of 500mm.

03 Gradients. The Amarok handles inclines up to 45°.¹

05 Traverse gradient. The broad wheelbase of the Amarok provides enormous stability even when traversing slopes with a 50° incline.^{1,2}

06 Off-road ABS. Once activated, the wheels lock when braking on loose surfaces with a larger interval, essentially digging the tyres into the surface creating a wedge which significantly reduces the braking distance. This noticeably increases the driving safety.

06 Hill Descent Assist. Allows you to drive down slopes in a safe, controlled way, thanks to the engine management's ability to govern the engine speed, and apply the brakes when driving off-road if necessary. The vehicle's speed is maintained at a constant crawling pace.

1 The values vary depending on the equipment and engine. 2 The incline on the left side is 49.7° and 50.8° on the right side.

Please note: these figures result from static calculations. The illustrations on these pages can only be regarded as a general guide. Please contact your local Volkswagen Commercial Vehicles Van Centre for details of the standard equipment and optional extras available.

Navigation menu with categories: Exterior, Interior & comfort, Safety systems, Off-road performance (active), Towing capacity & payload, Load platform, Equipment lines, Paint & upholstery, Alloy wheels, interior & comfort, Infotainment & assistance systems, Mobile online services, Technical information, Price list, Finance options, Finance, insurance, servicing & warranties.

More robust

Sturdy ladder frame design and an impressive towing capacity of up to 3.1 tonnes

Exceptionally robust and with a premium finish, the Amarok is built to impress, even in heavy use. A warp-resistant ladder frame, which guarantees excellent body stability, and special leaf springs allow for a maximum payload of up to 1,146 kilogrammes¹ and a trailer load of up to 3.1 tonnes.



The fixed **tow bar** with a ball head design is exceptionally durable and manufactured to tow a trailer load of up to 3.1 tonne braked.¹ Optional on all models.

The standard **3+2 leaf springs** offer high driving comfort and the highest UK payload.

¹ Amarok Trendline 3.0 litre V6 TDI 204PS 4MOTION. Please contact your local Volkswagen Commercial Vehicles Van Centre for details of the standard equipment and optional extras available.

| | | | | | | | | | | | | | | |
|----------|--------------------|----------------|----------------------|--------------------------------------|---------------|-----------------|--------------------|----------------------------------|-----------------------------------|------------------------|-----------------------|------------|-----------------|--|
| Exterior | Interior & comfort | Safety systems | Off-road performance | Towing capacity & payload | Load platform | Equipment lines | Paint & upholstery | Alloy wheels, interior & comfort | Infotainment & assistance systems | Mobile online services | Technical information | Price list | Finance options | Finance, insurance, servicing & warranties |
|----------|--------------------|----------------|----------------------|--------------------------------------|---------------|-----------------|--------------------|----------------------------------|-----------------------------------|------------------------|-----------------------|------------|-----------------|--|



Larger

The widest load platform in its class, allowing Euro pallets to be loaded crosswise

No other pick-up provides so much space between the wheel housings. The loading width of 1,222mm even enables Euro pallets to be loaded crosswise. The spacious 2.52m² cargo area features some impressive dimensions – such as the 508mm high side panels and the low loading sill height of 780mm.

Please contact your local Volkswagen Commercial Vehicles Van Centre for details of the standard equipment and optional extras available.



01 Load platform. The load platform in the Amarok is precisely 1,222mm across between the wheel housings – this is unique in its vehicle class and allows Euro pallets to be loaded across the platform. If necessary, the tailgate with a 200kg payload can be used as an extension of the load platform. When loaded to capacity, the cargo area offers space for 1.28m³ of bulk goods on a surface of 2.52m².

TL HL BE AVBE

02 Load platform lighting. Integrated lights illuminate the load platform, allowing you to load your cargo in the dark. In addition, it also features the integrated third brake light.

TL HL



03 Load compartment protective coating. The UV-resistant special coating in anthracite provides excellent protection against mechanical and chemical wear.

TL HL BE AVBE

04 12V sockets (not shown). Four 12V sockets are available, including one in the cargo area.

HL BE AVBE

■ Standard □ Optional at extra cost
TL | Trendline HL | Highline BE | Black Edition AVBE | Aventura Black Edition

| | | | | | | | | | | | | | | |
|----------|--------------------|----------------|----------------------|---------------------------|----------------------|-----------------|--------------------|----------------------------------|-----------------------------------|------------------------|-----------------------|------------|-----------------|--|
| Exterior | Interior & comfort | Safety systems | Off-road performance | Towing capacity & payload | Load platform | Equipment lines | Paint & upholstery | Alloy wheels, interior & comfort | Infotainment & assistance systems | Mobile online services | Technical information | Price list | Finance options | Finance, insurance, servicing & warranties |
|----------|--------------------|----------------|----------------------|---------------------------|----------------------|-----------------|--------------------|----------------------------------|-----------------------------------|------------------------|-----------------------|------------|-----------------|--|

More individual

A range of models with exclusive equipment



Please contact your local Volkswagen Commercial Vehicles Van Centre for details of the standard equipment and optional extras available.

Exterior

Interior & comfort

Safety systems

Off-road performance

Towing capacity & payload

Load platform

Equipment lines



Paint & upholstery

Alloy wheels, interior & comfort

Infotainment & assistance systems

Mobile online services

Technical information

Price list

Finance options

Finance, insurance, servicing & warranties

The Amarok Trendline

For every purpose

Starting from **£28,600†** [Please click here for more details.](#)

17 inch 'Posadas' alloy wheels.

Eight-speed automatic with Permanent 4MOTION as standard.

Body-coloured front bumper.



Please contact your local Volkswagen Commercial Vehicles Van Centre for details of the standard equipment and optional extras available.

Volkswagen Commercial Vehicles may change RRP's at any time (this includes where there are government changes in regulation and/or legislation). There may be a delay to any RRP displaying correctly on our materials. Always obtain prices from your chosen authorised Van Centre.

† Basic RRP excluding VAT.

| | | | | | | | | | | | | | | |
|----------|--------------------|----------------|----------------------|---------------------------|---------------|------------------------|--------------------|----------------------------------|-----------------------------------|------------------------|-----------------------|------------|-----------------|--|
| Exterior | Interior & comfort | Safety systems | Off-road performance | Towing capacity & payload | Load platform | Equipment lines | Paint & upholstery | Alloy wheels, interior & comfort | Infotainment & assistance systems | Mobile online services | Technical information | Price list | Finance options | Finance, insurance, servicing & warranties |
|----------|--------------------|----------------|----------------------|---------------------------|---------------|------------------------|--------------------|----------------------------------|-----------------------------------|------------------------|-----------------------|------------|-----------------|--|

The Amarok Trendline

For every purpose



Standard equipment Trendline

Starting from **£28,600†** [Please click here for more details.](#)

Audio and communications

- App-Connect
- Bluetooth® mobile phone preparation
- Composition Media DAB+ radio system with 6.33" touch-screen, voice enhancer, single MP3 compatible CD drive, SD card slot, USB interface, AUX-IN socket and six speakers
- Multifunction display plus
- Voice Control

Interior

- Carpet floor covering in cab and rear passenger area
- Centre console with cover for storage compartment
- 'Climatronic' air conditioning
- Cruise control
- Cup holder in cab
- Decorative inserts in Deep Inox
- Driver and front passenger seats with height adjustment and armrests
- Dust and pollen filter
- Electric windows
- Heater air vents in cab and rear passenger area
- Kemisu fabric upholstery
- Leather multifunction steering wheel, gearknob, gaiter and handbrake handle
- Moulded headlining
- Servotronic speed-related variable steering
- Smoking pack with individually mountable ashtray
- Storage compartments under front seats
- Three rear headrests
- Twin sun visors with vanity mirrors and airbag label on passenger sun visor
- Windscreen wiper intermittent control, including manual dimming mirror
- 12V sockets x 3

Exterior

- Black rear bumper with integrated step
- Body-coloured door mirrors, handles and front bumper with double chrome strip in upper grille
- Centre high-mounted brake light
- Door mirrors - electrically heated and adjustable
- Four load-lashing rings
- Front and rear fog lights
- Halogen twin headlights
- Headlight range adjustment
- Heated rear window
- Heat insulating glass
- Licence plate lighting
- Lockable tailgate
- Rear side windows and rear window in privacy glass
- Separate daytime running lights
- Trailer hitch preparation
- Wide wheel arch extensions

Safety and Security

- Airbags - driver and front passenger (with passenger deactivation), side and front head protection
- Anti-lock Braking System (ABS)
- Automatic Post-Collision Braking System
- Electronic Stabilisation Programme (ESP)
- Hill Hold Assist
- Remote central locking with interior locking switch and two remote folding keys
- Seatbelt warning when not engaged
- Thatcham Category 1 approved alarm and immobiliser with back-up horn, tilt sensor, tow-away protection and single door unlocking
- Three-seat bench in rear row with ISOFIX mountings (x2 outer seats)
- 17" braking system to the front and 16" braking system at the rear (204PS models only)

Wheels and tyres

- 17" 'Posadas' alloy wheels 8J x 17
- 245/65 R17 111T tyres
- Full size steel spare wheel
- Lockable wheel bolts
- Tool kit and jack



'Climatronic' air conditioning.



Composition Media DAB+ radio system.



17 inch 'Posadas' alloy wheel.

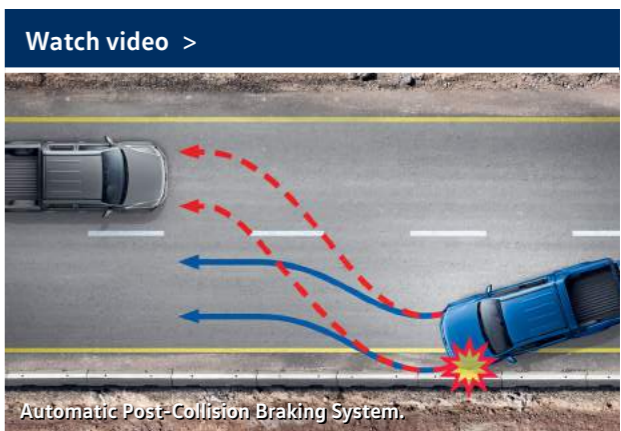

Automatic Post-Collision Braking System.

Please contact your local Volkswagen Commercial Vehicles Van Centre for details of the standard equipment and optional extras available

Volkswagen Commercial Vehicles may change RRP's at any time (this includes where there are government changes in regulation and/or legislation). There may be a delay to any RRP displaying correctly on our materials. Always obtain prices from your chosen authorised Van Centre.

† Basic RRP excluding VAT.

The Amarok Highline

For added refinement

Starting from **£32,680†** [Please click here for more details.](#)



- 18 inch 'Manaus' alloy wheel.
- Bi-xenon headlights.
- Chrome-plated rear bumper.
- Side bars in stainless steel.
- Two double chrome trims on the radiator grille.

Please contact your local Volkswagen Commercial Vehicles Van Centre for details of the standard equipment and optional extras available.

Volkswagen Commercial Vehicles may change RRP's at any time (this includes where there are government changes in regulation and/or legislation). There may be a delay to any RRP displaying correctly on our materials. Always obtain prices from your chosen authorised Van Centre.

† Basic RRP excluding VAT.

| | | | | | | | | | | | | | | |
|----------|--------------------|----------------|----------------------|---------------------------|---------------|------------------------|--------------------|----------------------------------|-----------------------------------|------------------------|-----------------------|------------|-----------------|--|
| Exterior | Interior & comfort | Safety systems | Off-road performance | Towing capacity & payload | Load platform | Equipment lines | Paint & upholstery | Alloy wheels, interior & comfort | Infotainment & assistance systems | Mobile online services | Technical information | Price list | Finance options | Finance, insurance, servicing & warranties |
|----------|--------------------|----------------|----------------------|---------------------------|---------------|------------------------|--------------------|----------------------------------|-----------------------------------|------------------------|-----------------------|------------|-----------------|--|

The Amarok Highline

For added refinement



Front and rear parking sensors and rear-view camera.

Heated driver and front passenger seats with individual settings.

'Vienna' leather seat upholstery.¹

¹ Centre seat panel and inner seat bolsters in 'Vienna' leather. The 'Vienna' upholstery is a leather seat upholstery with leatherette sections.

Please contact your local Volkswagen Commercial Vehicles Van Centre for details of the standard equipment and optional extras available.

Additional equipment

Highline

Starting from **£32,680†** [Please click here for more details.](#)

Interior

- Decorative inserts in Light Silver
- Heated driver and front passenger seats with individual control
- Vienna leather upholstery¹
- 12V sockets x 4, including x 1 in the cargo area

Exterior

- Additional exterior dust seals
- Bi-xenon headlights with separate LED daytime running lights
- Chrome rear bumper with integrated step
- Darkened rear tail light lenses
- Front and rear parking sensors with rear-view camera
- Front grille with two chrome detailing strips and six vertical chrome ribs
- Heated washer nozzles
- LED licence plate lighting
- Side bars in stainless steel
- Washer fluid level indicator

Wheels and tyres

- 18" 'Manaus' alloy wheels 7.5J x 18
- 255/60 R18 112T tyres



18 inch 'Manaus' alloy wheel.



Front and rear parking sensors.



Rear-view camera.



Bi-xenon headlights with separate LED daytime running lights.

¹ Centre seat panel and inner seat bolsters in 'Vienna' leather. The 'Vienna' upholstery is a leather seat upholstery with leatherette sections. Please contact your local Volkswagen Commercial Vehicles Van Centre for details of the standard equipment and optional extras available.

Volkswagen Commercial Vehicles may change RRP's at any time (this includes where there are government changes in regulation and/or legislation). There may be a delay to any RRP displaying correctly on our materials. Always obtain prices from your chosen authorised Van Centre.

† Basic RRP excluding VAT.

The Amarok Black Edition

For confident road presence

From **£34,835**†

Please click here for more details.

- 20 inch 'Talca' black alloy wheels.
- Black fog light surrounds.
- Black headlining.
- Black polish trim strip on grille.
- Black styling bar, rear bumper and side bars.
- Gloss black exterior mirror housings.
- Lights & Vision pack.



Exclusive Matt paint offer. **Save £780 + VAT.** >

Please contact your local Volkswagen Commercial Vehicles Van Centre for details of the standard equipment and optional extras available.

Volkswagen Commercial Vehicles may change RRP's at any time (this includes where there are government changes in regulation and/or legislation). There may be a delay to any RRP displaying correctly on our materials. Always obtain prices from your chosen authorised Van Centre.

† Basic RRP excluding VAT.

Additional equipment

Black Edition

From **£34,835** † [Please click here for more details.](#)

Audio and communications

Discover Media navigation system with Guide & Inform, SD card x 2 and Off-road information display

Interior

Black headlining
Gloss black decorative insert on dashboard

Exterior

Black fog light surrounds
Black rear bumper
Black side bars
Black styling bar
Black polish trim strip on grille
Gloss black exterior mirror housings
Lights & Vision pack

Wheels and tyres

20" 'Talca' black alloy wheels 8J x 20
255/50 R20 109H tyres



20 inch 'Talca' black alloy wheel.



Discover Media navigation system with Guide & Inform.

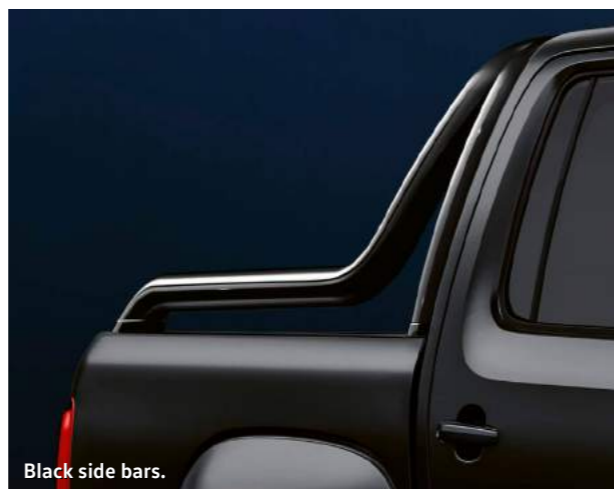

Black side bars.



Black fog light surrounds.

Please contact your local Volkswagen Commercial Vehicles Van Centre for details of the standard equipment and optional extras available

Volkswagen Commercial Vehicles may change RRP's at any time (this includes where there are government changes in regulation and/or legislation). There may be a delay to any RRP displaying correctly on our materials. Always obtain prices from your chosen authorised Van Centre.

† Basic RRP excluding VAT.

The Amarok Aventura Black Edition

More dynamic, more premium

From **£40,995** † [Please click here for more details.](#)



- 20 inch 'Talca' black alloy wheels.
- 'Aventura' sports bar painted in body colour.
- Black polish trim strip on grille.
- Black rear bumper and side bars.
- Front fog lights with cornering lights and black fog light surrounds.
- Gloss black exterior mirror housings. Power folding, heated and power adjustable.
- Lights & Vision pack.
- Load compartment protective coating.
- Underbody styling.

Exclusive Matt paint offer. Save £780 + VAT. >

Please contact your local Volkswagen Commercial Vehicles Van Centre for details of the standard equipment and optional extras available.

Volkswagen Commercial Vehicles may change RRP's at any time (this includes where there are government changes in regulation and/or legislation). There may be a delay to any RRP displaying correctly on our materials. Always obtain prices from your chosen authorised Van Centre.

† Basic RRP excluding VAT.

| | | | | | | | | | | | | | | |
|----------|--------------------|----------------|----------------------|---------------------------|---------------|------------------------|--------------------|----------------------------------|-----------------------------------|------------------------|-----------------------|------------|-----------------|--|
| Exterior | Interior & comfort | Safety systems | Off-road performance | Towing capacity & payload | Load platform | Equipment lines | Paint & upholstery | Alloy wheels, interior & comfort | Infotainment & assistance systems | Mobile online services | Technical information | Price list | Finance options | Finance, insurance, servicing & warranties |
|----------|--------------------|----------------|----------------------|---------------------------|---------------|------------------------|--------------------|----------------------------------|-----------------------------------|------------------------|-----------------------|------------|-----------------|--|

Additional equipment

Aventura Black Edition

From **£40,995†** [Please click here for more details.](#)

Audio and communications

Discover Media navigation system with Guide & Inform, SD card x 2 and Off-road information display

Interior

'Aventura' branded floor mats

Black headlining

'ErgoComfort' seats for driver and front passenger with 14-way adjustment (12 electrically, 2 manually)

Gloss black decorative insert on dashboard

Leather multifunction steering wheel with gear-shift paddles.

'Nappa' leather upholstery¹

'Premium' colour multifunction display

Exterior

Black fog light surrounds

Black polish trim strip on grille

Black rear bumper

Black side bars

Body coloured sports bar with stylish 'Aventura' emblem, attached on both sides

Front fog lights with cornering function

Gloss black exterior mirror housings

Lights & Vision pack

Load compartment protective coating

Underbody styling

Safety and Security

Exterior mirrors power adjustable, heated and folding

Wheels and tyres

20" 'Talca' black alloy wheels 8J x 20

255/50 R20 109H tyres

¹ Centre seat panel and inner seat bolsters in 'Nappa' leather. The 'Nappa' upholstery is a leather seat upholstery with leatherette sections.

Please contact your local Volkswagen Commercial Vehicles Van Centre for details of the standard equipment and optional extras available.



20 inch 'Talca' black alloy wheel.



Discover Media navigation system with Guide & Inform.



Body coloured sports bar with stylish 'Aventura' emblem, attached on both sides.



Underbody styling.

Volkswagen Commercial Vehicles may change RRP's at any time (this includes where there are government changes in regulation and/or legislation). There may be a delay to any RRP displaying correctly on our materials. Always obtain prices from your chosen authorised Van Centre.

† Basic RRP excluding VAT.

| | | | | | | | | | | | | | | |
|----------|--------------------|----------------|----------------------|---------------------------|---------------|-----------------|--------------------|----------------------------------|-----------------------------------|------------------------|-----------------------|------------|-----------------|--|
| Exterior | Interior & comfort | Safety systems | Off-road performance | Towing capacity & payload | Load platform | Equipment lines | Paint & upholstery | Alloy wheels, interior & comfort | Infotainment & assistance systems | Mobile online services | Technical information | Price list | Finance options | Finance, insurance, servicing & warranties |
|----------|--------------------|----------------|----------------------|---------------------------|---------------|-----------------|--------------------|----------------------------------|-----------------------------------|------------------------|-----------------------|------------|-----------------|--|

Paint



Candy White. Solid paint finish. TL HL BE AVBE



Tornado Red. Solid paint finish. TL HL BE



Reflex Silver. Metallic paint finish. TL HL BE AVBE



Mojave Beige. Metallic paint finish. TL HL



Indium Grey. Metallic paint finish. TL HL BE AVBE



Chestnut Brown. Metallic paint finish. TL HL



Starlight Blue. Metallic paint finish. TL HL BE AVBE



Ravenna Blue. Metallic paint finish. HL BE AVBE



Peacock Green. Metallic paint finish. BE AVBE



Deep Black. Pearl Effect paint finish. TL HL BE AVBE



Indium Grey. Matt paint finish. HL BE AVBE



Ravenna Blue. Matt paint finish. BE AVBE

Standard Optional at extra cost

TL | Trendline HL | Highline BE | Black Edition AVBE | Aventura Black Edition

The illustrations on these pages can only be regarded as a general guide. Screen technology cannot render the colours with absolute accuracy. Please contact your local Volkswagen Commercial Vehicles Van Centre for details of the standard equipment and optional extras available.

Upholstery

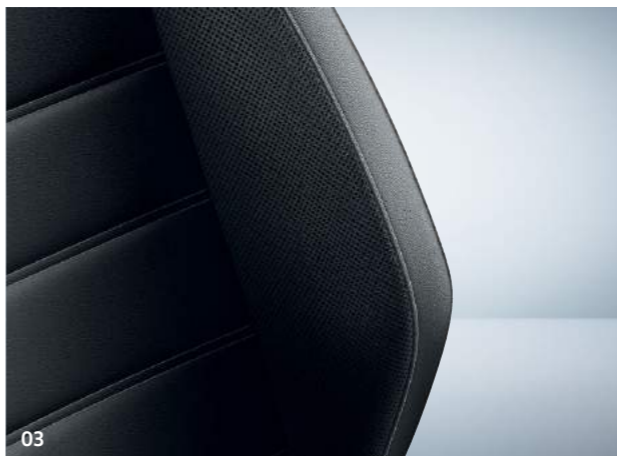
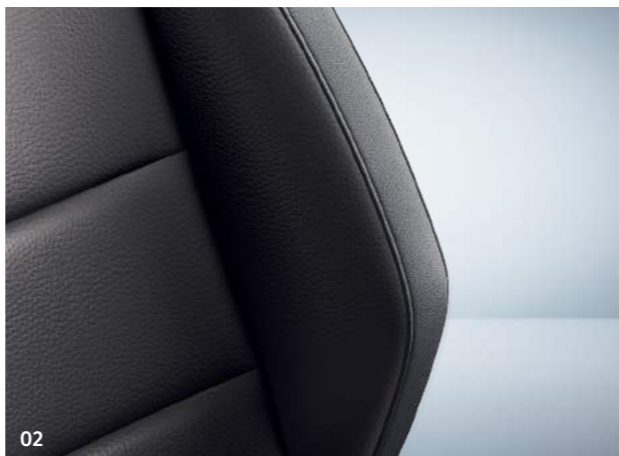
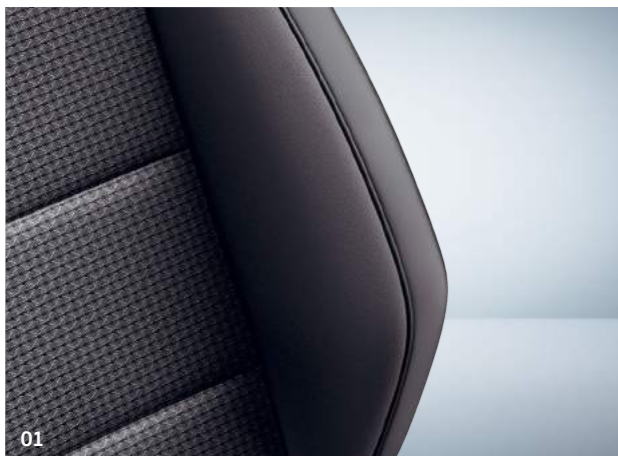

- 01 'Kemisu' cloth seat upholstery in Palladium Grey. **TL**
- 02 'Vienna'¹ leather seat upholstery in Palladium Grey and Titanium Black. Also available in Noisette Brown and Titanium Black. **HL BE**
- 03 'Nappa'² seat upholstery in Titanium Black. **AVBE**

1 Centre seat panel and inner seat bolsters in 'Vienna' leather. The 'Vienna' upholstery is a leather seat upholstery with leatherette sections.
 2 Centre seat panel and inner seat bolsters in 'Nappa' leather. The 'Nappa' upholstery is a leather seat upholstery with leatherette sections.
 The illustrations on these pages can only be regarded as a general guide. Screen technology cannot render the colours with absolute accuracy. Please contact your local Volkswagen Commercial Vehicles Van Centre for details of the standard equipment and optional extras available.

Standard Optional at extra cost
 TL | Trendline HL | Highline BE | Black Edition
 AVBE | Aventura Black Edition

Alloy wheels



- 01 17" 'Posadas' alloy wheel.** 8J x 17.
With 245/65 R17 111T tyres. TL
- 02 18" 'Manaus' alloy wheel.** 7.5J x 18.
With 255/60 R18 112T tyres. HL
- 03 19" 'Cantera' alloy wheel.** 8J x 19.
With 255/55 R19 111T tyres. HL
- 04 20" 'Talca' alloy wheel.** 8J x 20.
With 255/50 R20 109H tyres. HL
- 05 20" 'Talca' black alloy wheel.** 8J x 20.
With 255/50 R20 109H tyres. BE AVBE

Roll resistance-optimised tyres (not shown).
All Amarok models are equipped with fuel-conserving summer tyres as standard. These are manufactured from a special rubber compound which minimises deformation from driving. This can reduce fuel consumption depending on the speed and driving style.

Standard Optional at extra cost
TL | Trendline HL | Highline BE | Black Edition AVBE | Aventura Black Edition

Please contact your local Volkswagen Commercial Vehicles Van Centre for details of the standard equipment and optional extras available.

Interior and comfort



01 Leather-trimmed multifunction steering wheel with paddles. It gives you excellent grip and is extremely user-friendly. The radio or navigation system and even your mobile phone can be controlled using the buttons without taking your hands off the wheel for added safety. Ergonomic paddles allow you to change gears for a sportier driving style.

TL HL BE AVBE

02 'Climatronic' air conditioning. This system offers 2-zone temperature control for the driver and front passenger, manual air recirculation and an air quality sensor. Depending on the intensity of the sun's rays and the outside temperature, the air conditioning adds more or less cool air accordingly.

TL HL BE AVBE

Auxiliary water heater (not shown). It enables you to pre-heat the engine while also heating up the interior quicker, or pre-heating it before you get in. The control unit is built into the roof console. Of course, you can also activate and deactivate the auxiliary water heater using the handy remote control.

HL BE AVBE

03 'Premium' colour multifunction display. Positioned directly in front of you on the dashboard for your convenience and safety, it comes with a high-resolution 3D colour display and animated menu guidance. Optional as part of the Navigation Tech package on Amarok Highline models.

HL AVBE

Multifunction display plus (not shown). It displays up-to-date information, such as remaining range, outside temperature and average fuel consumption.

TL HL BE

Standard Optional at extra cost

TL | Trendline HL | Highline BE | Black Edition AVBE | Aventura Black Edition

Please contact your local Volkswagen Commercial Vehicles Van Centre for details of the standard equipment and optional extras available.

Infotainment



01



02 | 03



04

01 Voice control. Operate the telephone, navigation and audio functions without taking your hands off the steering wheel. This function allows you to call up virtually all of the menus and notifications on the radio or navigation system display using voice commands.

TL HL BE AVBE

Electronic voice enhancer (not shown).¹ This function makes sure that passengers in the rear seats can hear the driver. The voice input is recorded through a hands-free microphone, amplified, and then transmitted over the loudspeaker in the rear.

TL HL BE AVBE

02 Composition Media DAB+ radio system. The Composition Media DAB+ radio system features a 6.33 inch touch-screen with proximity sensor, USB port, Bluetooth®, SD card slot, AUX-IN interface, MP3 and WMA compatible CD drive, 4 x 20 watt output with six speakers and a dual tuner with PhaseDiversity for optimum radio reception. 'App-Connect' guarantees the best possible connection.²

TL HL

03 'App-Connect'.² With this software, selected apps from your smartphone can be used while driving. 'App-Connect' supports 'MirrorLink'™, Apple 'CarPlay' and 'Android Auto'.

TL HL BE AVBE

04 Discover Media navigation system. In addition to the Composition Media features, it also includes a second SD card slot and an SD card with map data for Europe. Volkswagen MapCare provides access to free updates for the installed maps. 'Guide & Inform' is an extension of the Discover Media navigation system and retrieves the latest information from the internet. If, for instance, a traffic jam is building, your chosen route will be changed in response to this. You can also choose to display the cheapest petrol station nearby, find car parks, get updates on the latest news and weather and much more. 'Guide & Inform' can be activated in just a few steps and used free-of-charge for three years.³

TL HL BE AVBE

■ Standard □ Optional at extra cost

TL | Trendline HL | Highline BE | Black Edition AVBE | Aventura Black Edition

¹ The electronic voice amplification is included in the Composition Media radio system and Discover Media navigation system.

² Compatible with 'MirrorLink'™, Apple 'CarPlay' and 'Android Auto'. Please ensure that your end device is compatible with 'App-Connect'. 'App-Connect' apps are operated exclusively through your mobile phone.

Please note the conditions of your contract with regard to the data and Internet connection. Further information is available at www.volkswagen-commercial-vehicles-carnet.com

³ Only available in conjunction with the Discover Media navigation system. From the fourth year, usage carries an extra charge. In order to establish an Internet connection, the customer will require their own mobile wireless router (e.g. a smartphone with Hotspot capability) or a suitable USB dongle that works with their own SIM card with an internet data tariff.

Please contact your local Volkswagen Commercial Vehicles Van Centre for details of the standard equipment and optional extras available.

| | | | | | | | | | | | | | | |
|----------|--------------------|----------------|----------------------|---------------------------|---------------|-----------------|--------------------|----------------------------------|-----------------------------------|------------------------|-----------------------|------------|-----------------|--|
| Exterior | Interior & comfort | Safety systems | Off-road performance | Towing capacity & payload | Load platform | Equipment lines | Paint & upholstery | Alloy wheels, interior & comfort | Infotainment & assistance systems | Mobile online services | Technical information | Price list | Finance options | Finance, insurance, servicing & warranties |
|----------|--------------------|----------------|----------------------|---------------------------|---------------|-----------------|--------------------|----------------------------------|-----------------------------------|------------------------|-----------------------|------------|-----------------|--|

Driver assistance systems

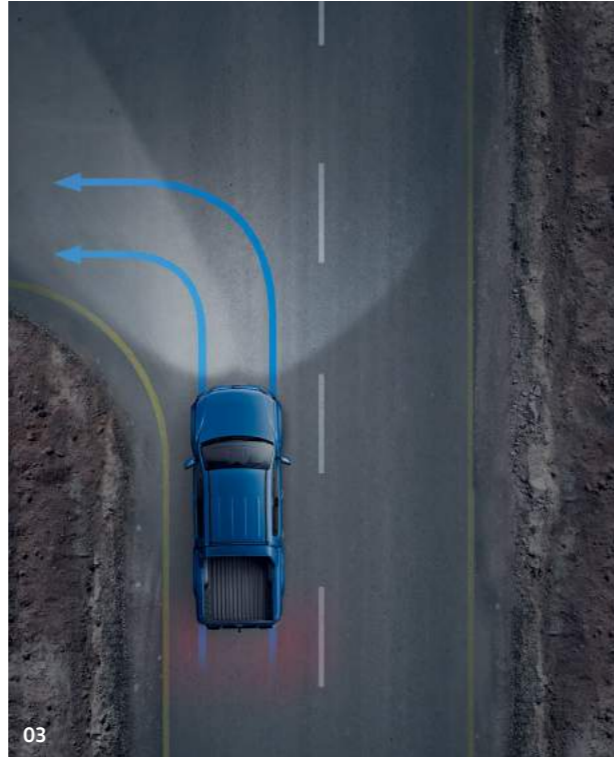

01 Parking sensors. Emits audible warnings when obstacles are detected in front of or behind the vehicle when parking, and also provides a visual display of the vehicle's distance from the obstacles. **TL HL BE AVBE**

02 Rear-view reversing camera. Simplifies parking by showing a limited view of the area behind the vehicle on the display of the radio or navigation system. Static guidelines facilitate the parking process. **HL BE AVBE**

Tyre pressure monitoring system (not shown). Measures the tyre pressure of each wheel on an ongoing basis and displays it on the multifunction display. The driver is warned if the pressure drops. **TL HL BE AVBE**

03 Fog lights with integrated static cornering lights. Ensures optimal visibility in poor weather conditions. The headlight nearest to the corner illuminates the roadside when turning. **TL HL BE AVBE**

Lights and Vision pack (not shown). The windscreen wipers are activated if it starts raining and the wiping interval is adapted to the intensity of the rainfall. Furthermore, the interior mirror is automatically tinted if the headlights in the vehicle behind are too bright. Also included in the package is an automatic headlight control for when light diminishes and the automatic 'coming home/leaving home' function. **TL HL BE AVBE**

■ Standard □ Optional at extra cost
TL | Trendline HL | Highline BE | Black Edition AVBE | Aventura Black Edition

Safety systems

01 Automatic Post-Collision Braking System. Triggers braking after a collision, with the aim of preventing secondary collisions. After a short delay, the vehicle begins a phased braking action down to 6mph, during which the driver can intervene at any time. **TL HL BE AVBE**

Electronic stabilisation programme (not shown). Helps to prevent under- or over-steering via targeted braking of individual wheels. **TL HL BE AVBE**

02 Trailer stabilisation. Should the trailer start to deviate heavily, the system slows it down by means of controlled braking and reduced engine torque. This helps the trailer and increases driving safety. **TL HL BE AVBE**

Anti-theft warning system (not shown). Triggers acoustic and visual warnings at signs of unauthorised entry. As well as interior monitoring, the system includes an electronic immobiliser, a safelock with deactivation and a tow-away warning. **TL HL BE AVBE**

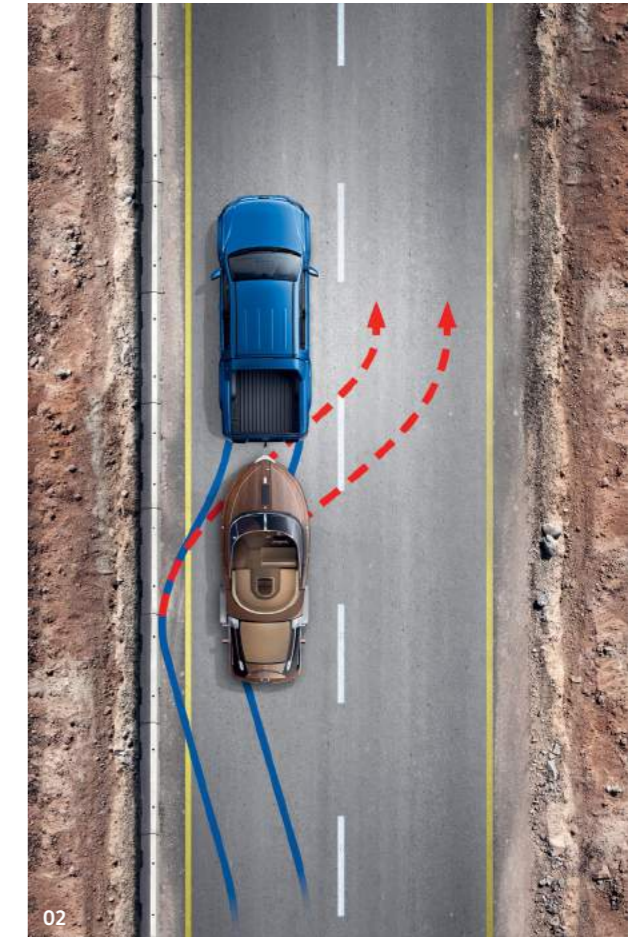
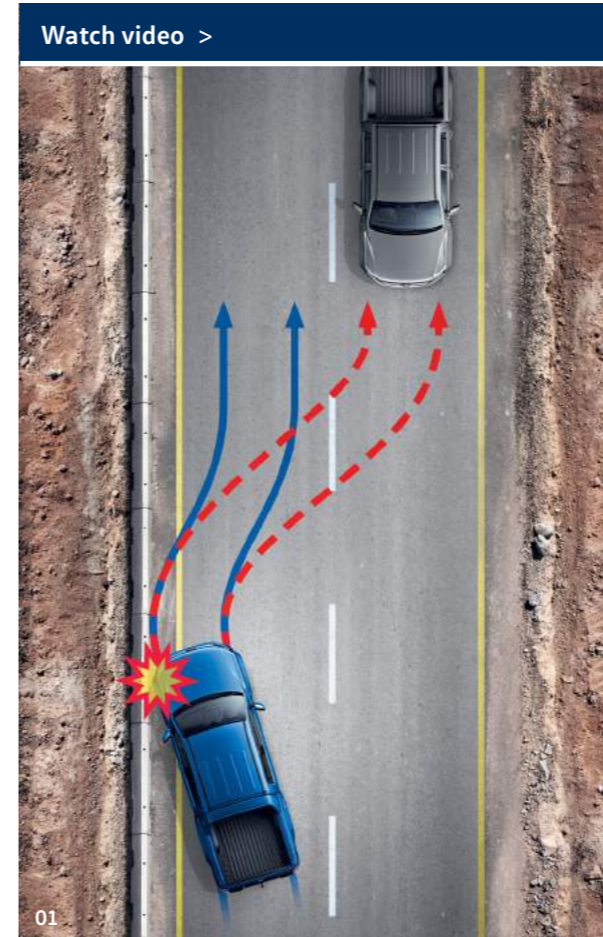

1 Within the system thresholds.

Please contact your local Volkswagen Commercial Vehicles Van Centre for details of the standard equipment and optional extras available.

Mobile online services – perfectly connected

The future of mobility is now the present – and available upon request in your Volkswagen commercial vehicle. The mobile online services enable you to enhance the Amarok, transforming it into an Internet-based information centre. 'App-Connect' enables you to conveniently use and control content on your smartphone even while driving.

TL HL BE AVBE

Using 'Guide & Inform', you expand the Discover Media navigation system to include numerous additional on-board information services.

TL HL BE AVBE



■ Standard □ Optional at extra cost
TL | Trendline HL | Highline
BE | Black Edition AVBE | Aventura Black Edition

| | | | | | | | | | | | | | | |
|----------|--------------------|----------------|----------------------|---------------------------|---------------|-----------------|--------------------|----------------------------------|-----------------------------------|-------------------------------|-----------------------|------------|-----------------|--|
| Exterior | Interior & comfort | Safety systems | Off-road performance | Towing capacity & payload | Load platform | Equipment lines | Paint & upholstery | Alloy wheels, interior & comfort | Infotainment & assistance systems | Mobile online services | Technical information | Price list | Finance options | Finance, insurance, servicing & warranties |
|----------|--------------------|----------------|----------------------|---------------------------|---------------|-----------------|--------------------|----------------------------------|-----------------------------------|-------------------------------|-----------------------|------------|-----------------|--|

Mobile online services (continued)

'App-Connect'.¹

Experience infotainment on the road and integrate your smartphone or tablet into your vehicle with 'App-Connect' via a USB port. 'App-Connect' mirrors compatible apps from your smartphone on the radio or navigation system's touchscreen display. Using 'Android Auto', Apple 'CarPlay' or 'MirrorLink™', you can comfortably control certain apps via the touchscreen display while driving.



You can use the following Volkswagen apps via 'MirrorLink™' while driving: 'Drive & Track', 'Shared Audio', 'Call & Remind' and 'My Guide'. More information is available at www.volkswagen-vans.co.uk/about-us/technology/car-net

'Guide & Inform'.²

If your vehicle is fitted with an optional navigation system, you can activate the online-based 'Guide & Inform' services. 'Guide & Inform' is available free of charge for the first three years after registration. You can utilise two types of services: services that support you directly in the vehicle and services you configure from home - either via the customer portal or via the Car-Net app. To use 'Guide & Inform' in the vehicle, simply generate a hotspot with your smartphone.

Well informed in your vehicle.

'Guide & Inform' keeps the driver up to date: with online-based traffic information, fuel station prices, available parking spaces nearby and a Google POI search in the navigation system.

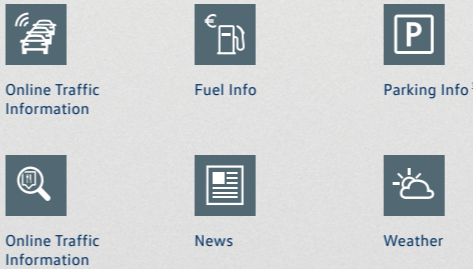

Well organised from home.

Using the customer portal, you can set-up online routes, destinations and POIs and then import them into the navigation system. The Car-Net app also synchronises calendar entries and driving destinations.

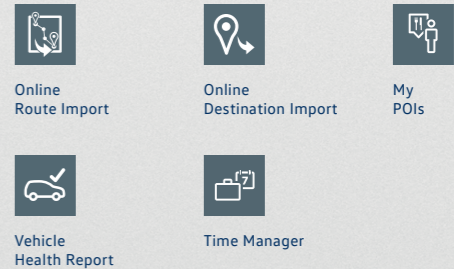

Registration - A few simple steps:

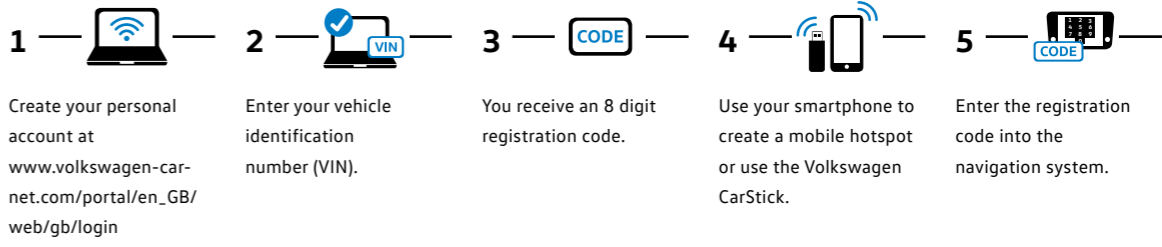

¹ 'App-Connect' is available in conjunction with the Composition Media radio system or the Discover Media systems. 'App-Connect' comprises MirrorLink™, CarPlay™ and Android Auto™. The availability of these technologies may vary depending on the country in question. Please note that 'App-Connect' is not currently supported by every mobile telephone on the market. Volkswagen is working closely with major smartphone producers to promote broader compatibility for 'App-Connect'. ² The use of 'Guide & Inform' mobile online services is only possible with the optional Discover Media system. You will also require a mobile device (e.g. smartphone) that is capable of acting as a mobile wireless hotspot, which must be paid for separately. The Guide & Inform services are only available with an existing mobile network contract or one to be concluded separately for this purpose between you and your mobile phone network provider, and only within the respective mobile phone network coverage. Depending on your mobile phone tariff, receiving data from the Internet may incur additional charges, particularly if you are using the phone abroad (e.g. roaming charges). Due to the amount of data needed when using Car-Net services, we strongly recommend signing up to a flat rate data plan with your mobile phone provider. Use of Car-Net is governed in a separate agreement concluded online with Volkswagen AG. After receiving possession of the vehicle, the customer has 90 days in which to register the vehicle at www.volkswagen-car-net.com/portal/en_GB/web/gb/login. Availability of Car-Net Services may vary depending on the country in question. These services are available for the duration of the contract term agreed, and may be subject to changes in terms of content during the contract period. More detailed information on Car-Net is available at www.volkswagen-vans.co.uk/about-us/technology/car-net and from your Volkswagen Partner; contact your mobile network provider for information on your mobile network tariff conditions. ³ Available for car parks with suitable technical infrastructure. There is currently no information available regarding entry heights for the car parks in question. Please contact your local Volkswagen Commercial Vehicles Van Centre for details of the standard equipment and optional extras available.

Engine & gearbox data

Engine specifications

| | 3.0 V6 TDI 204PS | 3.0 V6 TDI 258PS |
|--------------------------------------|--------------------------------------|--------------------------------------|
| Engine type | V6 cylinder diesel engine | V6 cylinder diesel engine |
| Mixture preparation/injection method | Common-rail/exhaust-gas turbocharger | Common-rail/exhaust-gas turbocharger |
| EU exhaust emission standard | EURO 6D Temp | EURO 6D Temp |
| Number of cylinders | 6 | 6 |
| Cubic capacity | 2,970cc | 2,970cc |
| Output, PS at rpm | 204 at 3,000-4,500 | 258 at 3,250-4,000 |
| Torque, max. Nm at rpm | 500 at 1,250-2,750 | 580 at 1,400-3,000 |
| Fuel tank capacity | 80 litre | 80 litre |
| AdBlue® tank capacity | 13 litre | 13 litre |
| Diesel Particulate Filter [DPF] | ● | ● |
| 8-speed automatic gearbox | ● | ● |
| Permanent 4MOTION all-wheel drive | ● | ● |
| Alternator | 120 A-180 A | 120 A-180 A |
| Battery | 92 Ah (520 A) | 92 Ah (520 A) |

● Standard ○ Available – Not available

Fuel consumption, performance & emissions

| | CO ₂ emissions, g/km ¹ , Max. | CO ₂ emissions, g/km ¹ , Min. | Combined fuel consumption mpg ¹ , Max. | Combined fuel consumption mpg ¹ , Min. | Combined fuel consumption (ltr/100km) ¹ , Max. | Combined fuel consumption (ltr/100km) ¹ , Min. | Acceleration, secs 0 - 62mph | Top speed, mph (where law permits) |
|---|---|---|---|---|---|---|------------------------------|------------------------------------|
| Trendline | | | | | | | | |
| 3.0 V6 TDI 204PS Permanent 4MOTION 8-speed automatic | 232 - 231 | | 25.9 - 28.2 | | 10.9 - 10.0 | | 9.1 | 118 |
| Highline | | | | | | | | |
| 3.0 V6 TDI 204PS Permanent 4MOTION 8-speed automatic | 232 - 231 | | 25.9 - 28.2 | | 10.9 - 10.0 | | 9.1 | 118 |
| 3.0 V6 TDI 258 PS Permanent 4MOTION 8-speed automatic | 232 - 231 | | 25.9 - 28.2 | | 10.9 - 10.0 | | 7.4 | 129 |
| Black Edition | | | | | | | | |
| 3.0 V6 TDI 204PS Permanent 4MOTION 8-speed automatic | 232 - 231 | | 25.9 - 28.2 | | 10.9 - 10.0 | | 9.1 | 118 |
| 3.0 V6 TDI 258 PS Permanent 4MOTION 8-speed automatic | 232 - 231 | | 25.9 - 28.2 | | 10.9 - 10.0 | | 7.4 | 129 |
| Aventura Black Edition | | | | | | | | |
| 3.0 V6 TDI 258 PS Permanent 4MOTION 8-speed automatic | 232 - 231 | | 25.9 - 27.7 | | 10.9 - 10.2 | | 7.4 | 129 |

¹ This brochure relates to vehicles tested according to WLTP technical procedures. Figures shown are for comparability purposes; only compare fuel consumption and CO₂ figures with other vehicles tested to the same technical procedures. These figures may not reflect real life driving results, which will depend upon a number of factors including the accessories fitted (post-registration), variations in weather, driving styles and vehicle load. There is a new test used for fuel consumption and CO₂ figures (known as WLTP). The CO₂ figures shown however, are based on a calculation designed to be equivalent to the outgoing (NEDC) test cycle and will be used to calculate vehicle tax on first registration. For more information please visit www.volkswagen-vans.co.uk/en/about-us/wltp.html or consult your authorised Volkswagen Van Centre.

Technical information (including fuel consumption, CO₂ emissions and range) is correct at 28.01.2020. We regularly update specifications so all technical information is subject to change (and this may include changes between order and delivery). There may be a delay in updates showing on our site – always consult your authorised Volkswagen Van Centre for the latest information.

Weights

| Engine/transmission | Gross vehicle weight ¹ , kg | Axle load limit, front/rear, kg | Trailer weight braked 12%/unbraked, kg | Gross train weight, kg | Unladen weight ² , kg | Payload ³ , kg |
|--|--|---------------------------------|--|------------------------|----------------------------------|---------------------------|
| Trendline | | | | | | |
| 3.0 V6 TDI 204PS Permanent 4MOTION 8-speed automatic | 3,290 | 1,445 / 1,930 | 3,100 / 750 | 6,000 | 2,143 | 1,147 |
| Highline | | | | | | |
| 3.0 V6 TDI 204PS Permanent 4MOTION 8-speed automatic | 3,290 | 1,445 / 1,930 | 3,100 / 750 | 6,000 | 2,180 | 1,110 |
| 3.0 V6 TDI 258PS Permanent 4MOTION 8-speed automatic | 3,290 | 1,445 / 1,930 | 3,100 / 750 | 6,000 | 2,180 | 1,110 |
| Black Edition | | | | | | |
| 3.0 V6 TDI 204PS Permanent 4MOTION 8-speed automatic | 3,290 | 1,445 / 1,930 | 3,100 / 750 | 6,000 | 2,220 | 1,070 |
| 3.0 V6 TDI 258PS Permanent 4MOTION 8-speed automatic | 3,290 | 1,445 / 1,930 | 3,100 / 750 | 6,000 | 2,220 | 1,070 |
| Aventura Black Edition | | | | | | |
| 3.0 V6 TDI 258PS Permanent 4MOTION 8-speed automatic | 3,290 | 1,445 / 1,930 | 3,100 / 750 | 6,000 | 2,260 | 1,030 |

1 These vehicles are WLTP (Worldwide Harmonised Light-Duty Vehicles Test Procedure) type approved vehicles. More information is available at www.volkswagen-vans.co.uk/about-us/wltp. However, to facilitate comparison between different models from different manufacturers and to accommodate the full transition to this new testing regime, we have displayed NEDC figures. These NEDC figures have been derived from WLTP testing, and may not be equivalent to NEDC figures from NEDC testing, so comparisons may be unreliable. Fuel consumption and efficiency figures are provided for comparative purposes only and may not reflect 'real world' driving results. Choice of wheels and other options may affect fuel consumption and emissions data.

2 Unladen weight includes approximately 90% fuel load.

3 Payload = gross vehicle weight minus unladen weight. Quoted weights are for vehicles with standard specification. Unladen weight and payload may be influenced by trimline, factory options and Van Centre fitted accessories. Roof load limit: 100kg. Trailer nose weight: 140kg.

Dimensions

| Amarok | | |
|-------------------------------|----------------------------|--------------------|
| Wheelbase | | 3,097 |
| Length | | 5,254 |
| Width | | 1,954 |
| Load area | length | 1,555 |
| | width | 1,620 |
| | width between wheel arches | 1,222 |
| | load area | 2.52m ² |
| Rear tailgate | width | 1,364 |
| | height | 508 |
| Ground clearance | | 192 |
| Wading depth | | 500 |
| Turning circle (wall to wall) | | 12.95m |

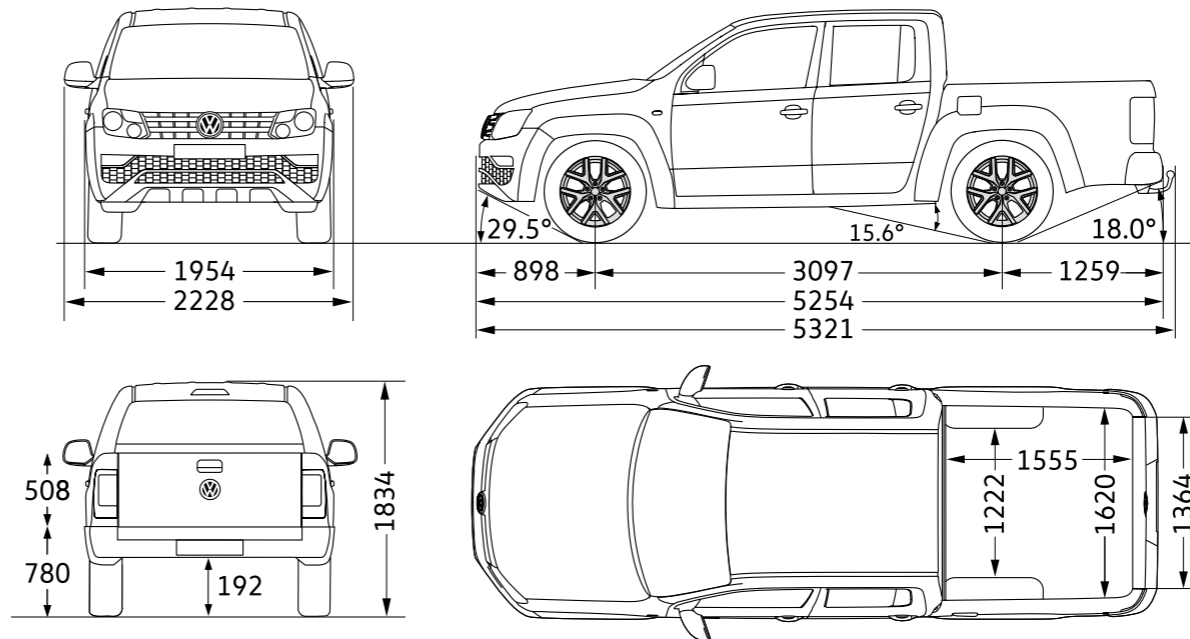

Please note: Vehicle drawings are not to scale. All dimensions in millimetres (mm), unless otherwise stated. The height measurements listed may vary by ± 50 mm depending on model and equipment fitted.

Model prices



Volkswagen Commercial Vehicles may change RRP's at any time (this includes where there are government changes in regulation and/or legislation). There may be a delay to any RRP displaying correctly on our materials. Always obtain prices from your chosen authorised Van Centre.

Please contact your local Volkswagen Commercial Vehicles Van Centre for details of the standard equipment and optional extras available.

*Manufacturer's on the road (OTR) package.

| | |
|------------------------------------|------------------|
| Delivery to Van Centre | £620.00 |
| Number plates | £20.00 |
| VAT | £128.00 |
| First registration fee | £55.00 |
| Vehicle excise duty (VED) 1st year | £265.00 |
| Basic OTR price (exc. VAT) | £960.00 |
| Total OTR price (inc. VAT) | £1,088.00 |

Model prices

| Trimline | Engine/transmission | Basic exc. VAT | Total inc. VAT | Total RRP inc. OTR* exc. VAT | Total RRP inc. OTR* inc. VAT |
|-------------------------------|---|-------------------|----------------|------------------------------|------------------------------|
| Trendline | | | | | |
| | 3.0 V6 TDI 204PS Permanent 4MOTION 8-speed automatic | £28,600.00 | £34,320.00 | £29,560.00 | £35,408.00 |
| Highline | | | | | |
| | 3.0 V6 TDI 204PS Permanent 4MOTION 8-speed automatic | £32,680.00 | £39,216.00 | £33,640.00 | £40,304.00 |
| | 3.0 V6 TDI 258 PS Permanent 4MOTION 8-speed automatic | £36,310.00 | £43,572.00 | £37,270.00 | £44,660.00 |
| Black Edition | | | | | |
| | 3.0 V6 TDI 204PS Permanent 4MOTION 8-speed automatic | £34,835.00 | £41,802.00 | £35,795.00 | £42,890.00 |
| | 3.0 V6 TDI 258 PS Permanent 4MOTION 8-speed automatic | £38,465.00 | £46,158.00 | £39,425.00 | £47,246.00 |
| Aventura Black Edition | | | | | |
| | 3.0 V6 TDI 258 PS Permanent 4MOTION 8-speed automatic | £40,995.00 | £49,194.00 | £41,955.00 | £50,282.00 |

* Please [click here](#) for more details on manufacturer's on the road (OTR) package.

Volkswagen Commercial Vehicles may change RRP's at any time (this includes where there are government changes in regulation and/or legislation). There may be a delay to any RRP displaying correctly on our materials. Always obtain prices from your chosen authorised Van Centre.

Options

| | PR Code | Trendline | | Highline | | Black Edition | | Aventura Blk Edition | |
|---|----------|----------------|--------------------|----------------|--------------------|----------------|--------------------|----------------------|--------------------|
| | | Basic exc. VAT | Total RRP inc. VAT | Basic exc. VAT | Total RRP inc. VAT | Basic exc. VAT | Total RRP inc. VAT | Basic exc. VAT | Total RRP inc. VAT |
| Paint | | | | | | | | | |
| Solid. Candy White (B4B4), Tornado Red (G2G2) ¹ . | As shown | ○ | ○ | ○ | ○ | ○ | ○ | ○ | ○ |
| Metallic. Peacock Green (8U8U). | As shown | - | - | - | - | £575.00 | £690.00 | £575.00 | £690.00 |
| Metallic. Chestnut Brown (H4H4) ^{1,2} , Indium Grey (X3X3), Mojave Beige (1B1B) ^{1,2} , Reflex Silver (8E8E), Ravenna Blue (5Z5Z) ³ or Starlight Blue (3S3S). | As shown | £575.00 | £690.00 | £575.00 | £690.00 | £575.00 | £690.00 | £575.00 | £690.00 |
| Pearl effect. Deep Black (2T2T). | As shown | £575.00 | £690.00 | £575.00 | £690.00 | £575.00 | £690.00 | £575.00 | £690.00 |
| Matt. Indium Grey (9709). Includes grained black door handles and wing mirror housings with lower chrome plating. | | - | - | £3,265.00 | £3,918.00 | £2,485.00 | £2,982.00 | £2,485.00 | £2,982.00 |
| Ravenna Blue (9547). Includes grained black door handles and wing mirror housings with lower chrome plating. | As shown | - | - | - | - | £2,485.00 | £2,982.00 | £2,485.00 | £2,982.00 |
| Upholstery | | | | | | | | | |
| Seat trim covers in Palladium Grey/Titanium Black Kemisu fabric. Dashboard in Titanium Black, floor covering in Black. | N0L | ● | ● | - | - | - | - | - | - |
| Seat trim covers in Palladium Grey/Titanium Black Vienna leather.⁴ Dashboard in Titanium Black, floor covering in Black. | N1D | - | - | ● | ● | ● | ● | - | - |
| Seat trim covers in Noisette Brown/Titanium Black Vienna leather.⁴ Dashboard in Titanium Black, floor covering in Black. | N1D | - | - | ● | ● | ● | ● | - | - |
| Seat trim covers in Titanium Black Nappa leather.⁴ Dashboard in Titanium Black, floor covering in Black. | N4L | - | - | - | - | - | - | ● | ● |
| Seating | | | | | | | | | |
| ErgoComfort driver and front passenger seats with 14-way adjustment. 12 electrically, 2 manually. | ZSB | - | - | £1,100.00 | £1,320.00 | £1,100.00 | £1,320.00 | ● | ● |
| Lumbar support (manual) for driver and front passenger seats. | 7P4 | £140.00 | £168.00 | £140.00 | £168.00 | £140.00 | £168.00 | - | - |

● Standard - Not available ○ At no extra cost Where additional equipment is required by chosen options, additional equipment will be charged at the prices shown.

1 Tornado Red solid paint, Chestnut Brown and Mojave Beige metallic paints are not available on Aventura.

2 Chestnut Brown and Mojave Beige metallic paints are not available on Black Edition.

3 Ravenna Blue metallic paint is not available on Trendline.

4 Seat material in contact with driver and passengers is leather, all other areas are leatherette.

Volkswagen Commercial Vehicles may change RRP's at any time (this includes where there are government changes in regulation and/or legislation). There may be a delay to any RRP displaying correctly on our materials. Always obtain prices from your chosen authorised Van Centre.

Options (continued)

| | | Trendline | | Highline | | Black Edition | | Aventura Blk Edition | | |
|---|---------|----------------|--------------------|----------------|--------------------|----------------|--------------------|----------------------|--------------------|--|
| | PR Code | Basic exc. VAT | Total RRP inc. VAT | Basic exc. VAT | Total RRP inc. VAT | Basic exc. VAT | Total RRP inc. VAT | Basic exc. VAT | Total RRP inc. VAT | |
| Wheels and tyres | | | | | | | | | | |
| 17" 'Posadas' alloy wheels. 8J x 17. | CA6 | ● | ● | - | - | - | - | - | - | |
| 18" 'Manaus' alloy wheels. 7.5J x 18. | CV1 | - | - | ● | ● | - | - | - | - | |
| 19" 'Cantera' alloy wheels. 8J x 19. With steel space saver spare wheel. | ZRQ | - | - | £495.00 | £594.00 | - | - | - | - | |
| 20" 'Talca' alloy wheels. 8J x 20. | ZRA | - | - | £1,295.00 | £1,554.00 | - | - | - | - | |
| 20" 'Talca' black alloy wheels. 8J x 20. | 48P | - | - | - | - | ● | ● | ● | ● | |
| Audio and communications | | | | | | | | | | |
| Composition Media DAB+ radio system with 6.33" touch-screen. Includes six speakers and App-Connect. | ZI4 | ● | ● | ● | ● | - | - | - | - | |
| Discover Media DAB+ navigation system. Includes Guide & Inform, SD card x2, European map data and Off-road information display. | RI7 | £600.00 | £720.00 | £600.00 | £720.00 | ● | ● | ● | ● | |
| Comfort and convenience | | | | | | | | | | |
| Carpet floor covering in cab – in lieu of rubber. | 5AD | ● | ● | ● | ● | ● | ● | ● | ● | |
| Rubber floor covering in cab. | ZB2 | £110.00 | £132.00 | £110.00 | £132.00 | £110.00 | £132.00 | £110.00 | £132.00 | |
| Storage compartment under front seats. | QN4 | ● | ● | ● | ● | ● | ● | ● | ● | |
| Driver assistance | | | | | | | | | | |
| Leather multi-function steering wheel. | 2ZH | ● | ● | ● | ● | ● | ● | - | - | |
| Leather multi-function steering wheel with gear-shift paddles – automatic only. | ZM1 | £130.00 | £156.00 | £130.00 | £156.00 | £130.00 | £156.00 | ● | ● | |
| Parking sensors, front and rear. | 7X2 | £445.00 | £534.00 | ● | ● | ● | ● | ● | ● | |

● Standard – Not available ○ At no extra cost Where additional equipment is required by chosen options, additional equipment will be charged at the prices shown.

Volkswagen Commercial Vehicles may change RRP's at any time (this includes where there are government changes in regulation and/or legislation). There may be a delay to any RRP displaying correctly on our materials. Always obtain prices from your chosen authorised Van Centre.

Options (continued)

| Packages | PR Code | Trendline | | Highline | | Black Edition | | Aventura Blk Edition | |
|--|---------|----------------|--------------------|----------------|--------------------|----------------|--------------------|----------------------|--------------------|
| | | Basic exc. VAT | Total RRP inc. VAT | Basic exc. VAT | Total RRP inc. VAT | Basic exc. VAT | Total RRP inc. VAT | Basic exc. VAT | Total RRP inc. VAT |
| Centre high-mounted LED brake light. | 8R4 | ● | ● | ● | ● | - | - | ● | ● |
| Centre high-mounted LED brake light with cargo area lighting. | 8R1 | £25.00 | £30.00 | £25.00 | £30.00 | - | - | - | - |
| Chrome style pack. ¹ Chrome-effect stainless steel styling bar and side bars without step. | YFE | £1,645.00 | £1,974.00 | £1,120.00 | £1,344.00 | - | - | - | - |
| Lights & Vision pack. Includes automatic headlights with separate daytime running lights, Coming Home feature, windscreen wiper intermittent control with rain sensor. | ZL2 | £200.00 | £240.00 | £200.00 | £240.00 | ● | ● | ● | ● |
| Load compartment protective coating. | YMB | £720.00 | £864.00 | £720.00 | £864.00 | £720.00 | £864.00 | ● | ● |
| Side bars. | YJB | - | - | ● | ● | ● | ● | ● | ● |
| Navigation Tech pack. Includes Discover Media navigation system, tyre pressure warning light, 'Premium' colour multi-function display, upgraded anti-theft alarm system (to include all door unlocking) and power folding wing mirrors. | ZBB | - | - | £1,000.00 | £1,200.00 | - | - | - | - |
| Without model and engine designation badges. | ONM | ○ | ○ | ○ | ○ | ○ | ○ | ○ | ○ |
| Without model designation badge, with engine designation badge. | ONA | ○ | ○ | ○ | ○ | ○ | ○ | ○ | ○ |

Body and chassis

| | | | | | | | | | |
|--|-----|---------|---------|---------|---------|----------|----------|---------|---------|
| Additional underbody protection to front. | 1SB | £25.00 | £30.00 | £25.00 | £30.00 | £25.00 | £30.00 | - | - |
| Differential lock. | 1Y4 | £270.00 | £324.00 | £270.00 | £324.00 | £270.00 | £324.00 | £270.00 | £324.00 |
| Lockable easy-opening tailgate. | 3RQ | ● | ● | ● | ● | ● | ● | ● | ● |
| Remove styling bar. | W42 | - | - | - | - | -£500.00 | -£600.00 | - | - |
| Towbar, fixed ball. ² With 13-pin socket and electrics. | 1D1 | £320.00 | £384.00 | £320.00 | £384.00 | £320.00 | £384.00 | £320.00 | £384.00 |
| Towbar, preparation. | 1D7 | ● | ● | ● | ● | ● | ● | ● | ● |
| Without mudflaps. | 6N0 | ● | ● | ● | ● | - | - | - | - |
| Wing mirrors. Heated and power adjustable. | 6XD | ● | ● | ● | ● | ● | ● | - | - |
| Wing mirrors. Heated, power adjustable and power folding. Highline still includes chrome housing. | 6XE | - | - | £140.00 | £168.00 | £140.00 | £168.00 | ● | ● |

● Standard - Not available ○ At no extra cost Where additional equipment is required by chosen options, additional equipment will be charged at the prices shown.

1 Not in conjunction with any hardtop or load compartment cover e.g. roll and lock. 2 Towbar. An adapter is available from Van Centres to allow connection to twin 7-pin sockets.

Volkswagen Commercial Vehicles may change RRP's at any time (this includes where there are government changes in regulation and/or legislation). There may be a delay to any RRP displaying correctly on our materials. Always obtain prices from your chosen authorised Van Centre.

Options (continued)

| | PR Code | Trendline | | Highline | | Black Edition | | Aventura Blk Edition | |
|--|---------|----------------|--------------------|----------------|--------------------|----------------|--------------------|----------------------|--------------------|
| | | Basic exc. VAT | Total RRP inc. VAT | Basic exc. VAT | Total RRP inc. VAT | Basic exc. VAT | Total RRP inc. VAT | Basic exc. VAT | Total RRP inc. VAT |
| Cargo area | | | | | | | | | |
| Load-lashing rings. | 6B1 | ● | ● | ● | ● | ● | ● | ● | ● |
| Load-lashing rings. Six folding load-lashing rings. | 6B7 | £40.00 | £48.00 | £40.00 | £48.00 | £40.00 | £48.00 | £40.00 | £48.00 |
| Electrical | | | | | | | | | |
| Body builder interface for external device. | IS1 | £65.00 | £78.00 | £65.00 | £78.00 | £65.00 | £78.00 | £65.00 | £78.00 |
| Tachograph preparation. | 9ND | £255.00 | £306.00 | £255.00 | £306.00 | £255.00 | £306.00 | £255.00 | £306.00 |
| Heating and ventilation | | | | | | | | | |
| Climatronic air-conditioning system. | KH4 | ● | ● | ● | ● | ● | ● | ● | ● |
| Water heater with programmable parking heater function and radio remote control. | 7VL | - | - | £1,220.00 | £1,464.00 | £1,220.00 | £1,464.00 | £1,220.00 | £1,464.00 |
| Safety and security | | | | | | | | | |
| First aid kit with warning triangle and hi-vis vest. | 1T9 | £35.00 | £42.00 | £35.00 | £42.00 | £35.00 | £42.00 | £35.00 | £42.00 |
| Front fog lights. | 8WB | ● | ● | ● | ● | ● | ● | - | - |
| Front fog lights with cornering lights. | 8WH | £85.00 | £102.00 | £85.00 | £102.00 | £85.00 | £102.00 | ● | ● |
| Tyre pressure warning light. | 7K3 | £170.00 | £204.00 | £170.00 | £204.00 | £170.00 | £204.00 | £170.00 | £204.00 |

● Standard - Not available ○ At no extra cost Where additional equipment is required by chosen options, additional equipment will be charged at the prices shown.

Volkswagen Commercial Vehicles may change RRP's at any time (this includes where there are government changes in regulation and/or legislation). There may be a delay to any RRP displaying correctly on our materials. Always obtain prices from your chosen authorised Van Centre.

Finance made simple

As dedicated to finance as we are to your new Amarok

Learn more about our range of finance products to find a finance package that suits your budget. Alternatively, 'Click on' the Offers & Finance button above to find out more about our latest offers to help your business thrive.

Cost of your vehicle

Deposit
As little as one monthly repayment

Monthly repayments
Spread across 18 to 49 months

Optional final payment
You have three choices at the end of your agreement

Solutions Personal Contract Plan

Not sure if you want to own or hire? Make the decision later. Pay monthly payments for the length of your agreement. At the end you can decide to keep (once all payments have been made), upgrade or return the vehicle.

Cost of your vehicle

Deposit
As little as one monthly repayment

Repayments
Spread across 12 to 60 months

Hire Purchase

Make all the regular monthly payments. At the end the vehicles is yours.

Cost of your vehicle

Deposit
As little as one monthly repayment

Rental repayments
Spread across 12 to 48 months

Final 'balloon' repayment

Lease Purchase

Make lower monthly payments by deferring an amount until the end. Once paid the vehicle is yours.

Cost of your vehicle

Initial rental
As little as one rental repayment

Rental repayments
Spread across 12 to 60 months

Contract Hire

Pay fixed monthly rentals to hire the vehicle. Look after it so at the end you can return it hassle free.

Cost of your vehicle

Initial rental
As little as one rental repayment in advance

Rental repayments
Spread across 12 to 60 months

Finance Lease (full pay out)

Pay monthly rentals to hire the vehicle. At the end you have two options. Sell the vehicle and receive a percentage of the sale proceeds. Or retain the use of your vehicle by paying a reduced annual rental.

Cost of your vehicle

Initial rental
As little as one rental repayment in advance

Rental repayments
Spread across 12 to 48 months

Final 'balloon' repayment
You have two options at the end of your agreement

Finance Lease (balloon repayment)

Pay monthly rentals to hire the vehicle. At the end you have two options. Sell the vehicle to settle the outstanding amount and receive any excess sale proceeds. Or pay the 'balloon' payment and retain the use of your vehicle by paying a reduced annual rental.

Finance subject to status. Available to 18s and over in the UK only. Terms and Conditions apply. Volkswagen Commercial Vehicle Financial Services.

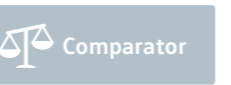

Finance, insurance, servicing and warranties

Finance and insurance.¹

When it comes to paying for your van, we've got options including Contract Hire and Finance Lease, or Hire Purchase. We can also offer you competitive insurance with lots of features and benefits as standard.

A choice of packages.²

Whether you prefer to lease your vehicles, with none of the concerns of ownership and the freedom to change models easily, or purchase outright to own the vehicle that's perfect for your business, we're here to help you consider your options.

You can go flexible, by choosing a payment plan that suits your finances, with options to reduce your monthly costs and your repayment period. Or choose a fixed monthly price that allows you to budget confidently for the longer term.

You can even include your road tax and servicing costs to arrive at one simple, all-inclusive payment. For more information, pick up a finance brochure, or ask at your Van Centre.

Volkswagen Commercial Vehicle Van Insurance.³

Complimentary Drive Away Insurance

Every new and used Volkswagen Commercial Vehicle comes with five days' complimentary Drive Away Insurance, so you can enjoy your new vehicle from day one. We will also provide you with a quote, giving you the option to purchase annual cover, so you can enjoy the same peace-of-mind for a further twelve months. Please speak to your local Volkswagen Van Centre for further details.

Subject to eligibility. Five days' Drive Away Insurance cannot be used in conjunction with any other insurance offer.

Annual Insurance

Comprehensive van insurance, designed specifically for Volkswagen Commercial Vehicles, to offer you maximum convenience with minimum hassle – just as you'd expect.

If you take out a new Volkswagen Commercial Vehicle Van Insurance policy you will receive the following benefits at no additional cost:

- All repairs are carried out by Volkswagen Commercial Vehicles' Trained Technicians in Volkswagen Commercial Vehicles' Authorised Repairers
- Genuine parts and accessories (excludes windscreen claims)
- Courtesy van while yours is being repaired
- Cover for the full cost of repairs to chips or other small damage to your windscreen
- Up to 90 days' foreign travel cover, when using your van abroad
- Up to £250 cover for personal belongings that are lost or damaged following an accident, fire or theft

For more information or to get a quote, call us on: **0345 877 6355**

We're available Monday to Friday 9am-6pm.

Alternatively, visit: www.insurewithvwcv.co.uk

Volkswagen Commercial Vehicle GAP Insurance.⁴

If your Volkswagen Commercial Vehicle is written off, your motor insurer will usually settle your claim based on the current market value of your vehicle. This could be substantially less than the original value of your vehicle.

Volkswagen Commercial Vehicle GAP (also known as 'Guaranteed Asset Protection') Insurance helps to bridge the payment gap to get you back in a new Volkswagen Commercial Vehicle. Whether you purchase, finance, lease or hire your vehicle, Volkswagen Commercial Vehicle GAP Insurance is available and can be arranged up to 60 days after you have collected your new or used vehicle.

For more information about Volkswagen Commercial Vehicle GAP Insurance, visit: www.insurewithvwcv.co.uk/gap-insurance

Servicing and support.

We're here to keep your business moving, with our range of three award-winning⁵ servicing and maintenance options, as well as free Roadside Assistance. Some exclusions apply. For more detail, please visit: www.volkswagen-vans.co.uk/aftersales

Fixed cost maintenance.

This option is available for vehicles that are less than twelve months old and have covered less than 10,000 miles. It makes budgeting easier by splitting the cost of servicing into fixed monthly payments – whether you want Service only; Service and Maintenance; or Service, Maintenance and Tyres.

Fixed price servicing.⁶

If you can pay for more than one service upfront, we'll help by reducing your costs. Buy two upfront and you'll receive one interim and one full service at a discounted rate. Buy four and you'll receive two interim and two full services, with your next MOT also included. You can also spread the cost with monthly payments, helping you budget⁷.

Pay on demand.

If you're looking for freedom and flexibility with your servicing, it's good to know we're ready when you are. So with our third option, you can choose to pay for your services as and when you need them, with our National Service Pricing. Ask your Van Centre for an up-to-date pricing guide.

Roadside Assistance.

We understand the need to keep you mobile. That's why all new vans come with three-year, unlimited mileage roadside cover. Should the unexpected happen, one call gets you straight through to a team trained to help you through any breakdown or accident. Supporting you every day will be a team of vehicle technicians, fully-trained by Volkswagen and carrying the latest diagnostic equipment, specialist tools and parts.

Assistance benefits include:

- Assistance at home, by the roadside or place of work.
- Recovery to your preferred location.
- Onward travel, for you and your cargo.
- Cover 24 hours a day, 365 days a year.
- Free cover for three years (on new vehicles).
- Unlimited mileage.
- European cover.
- Option to extend cover beyond three years.

Warranties.

You can count on us long after you purchase your Amarok, thanks to its comprehensive three-year, 100,000 mile warranty. You choose Volkswagen because your business depends on it, year in, year out. While your Amarok is under warranty, we'll fix any defect in manufacture or workmanship free of charge, even if you purchase and service the vehicle at different Van Centres. Some exclusions apply and the vehicle must be cared for using the guidance in your owner's manual.

For more detail, please visit: www.volkswagen-vans.co.uk/aftersales.

Extended warranty.

You can also extend your warranty beyond the three-year, 100,000 mile period, choosing either Comprehensive or Major Component cover, as a one-off or monthly payment.

For more detail of cover levels, along with terms and conditions, please visit: www.volkswagencvwarranty.co.uk where you'll also be able to obtain a quote and purchase an extended warranty.

Paint and body warranty.

Your Amarok's exterior paintwork is covered against manufacturing defects for a period of three years, while its body sections and panels are covered against rusting through from the inside for twelve years. Some exclusions apply and the vehicle must be cared for using the guidance in your owner's manual.

The Van Centre network.

Our **dedicated Van Centre network** is at the core of everything we do and is always there to help. As a separate brand within the Volkswagen Group, it makes sense to make use of your nearest Van Centre – it's full of experts who understand your vehicle better than anyone else and can help you to get the most out of it.

Over **65 Van Centres** and **30 Authorised Repairers**, means you're only around 45 minutes on average from our door.

1 Volkswagen Commercial Vehicles Insurance and Volkswagen Commercial Vehicle Financial Services are trading names of Volkswagen Financial Services (UK) Limited, Brunswick Court, Yeomans Drive, Blakelands, Milton Keynes MK14 5LR, which is authorised and regulated by the Financial Conduct Authority (FCA). Registered in England and Wales number: 2835230. Volkswagen Financial Services (UK) Limited financial services register number is 311988.

2 An offer of finance depends on certain conditions. Finance subject to status. Available to 18s and over. Terms and conditions apply. Volkswagen Commercial Vehicle Financial Services.

3 Volkswagen Commercial Vehicle Insurance is arranged by U K Insurance Business Solutions Limited and is underwritten by U K Insurance Limited. Calls may be recorded. Volkswagen Commercial Vehicle Financial Services is a trading name of Volkswagen Financial Services (UK) Limited ('VWFS UK'). Registered office: Brunswick Court, Yeomans Drive, Blakelands, Milton Keynes MK14 5LR. Volkswagen Insurance Service (Great Britain) Limited is an appointed representative of VWFS UK. VWFS UK is authorised and regulated by the Financial Conduct Authority. VWFS UK and U K Insurance Limited are not part of the same corporate group.

4 Volkswagen Commercial Vehicle GAP Insurance is administered by Abraxas Insurance Administration Services and underwritten by MAPFRE Asistencia Compañía Internacional de Seguros y Reaseguros, S.A. ('MAPFRE'). VWFS UK is not part of the same corporate group as MAPFRE and Abraxas Insurance Administration Services Limited.

5 Business Vans Awards 2014 and 2015: Best Service Package for Van Owners.

6 Class 4 MOT only. This option is available to all new and used vehicles up to seven years old with no mileage restrictions.

7 Pay monthly option eligible on vehicles with under 200,000 miles at point of activation.

| | | | | | | | | | | | | | | |
|----------|--------------------|----------------|----------------------|---------------------------|---------------|-----------------|--------------------|----------------------------------|-----------------------------------|------------------------|-----------------------|------------|-----------------|--|
| Exterior | Interior & comfort | Safety systems | Off-road performance | Towing capacity & payload | Load platform | Equipment lines | Paint & upholstery | Alloy wheels, interior & comfort | Infotainment & assistance systems | Mobile online services | Technical information | Price list | Finance options | Finance, insurance, servicing & warranties |
|----------|--------------------|----------------|----------------------|---------------------------|---------------|-----------------|--------------------|----------------------------------|-----------------------------------|------------------------|-----------------------|------------|-----------------|--|

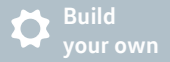

Build
your own



Find a
Van Centre



Test drive



Offers &
Finance



Conversions



Comparator



The Amarok

This brochure supersedes all previous publications.
Issue: 1 April 2020
www.volkswagen-vans.co.uk

Please note: Screen technology does not allow exact reproduction of the paint and upholstery colours. Some of the vehicles shown are European specification and may be fitted with optional equipment or accessories that are available at extra cost, or do not reflect current specification. All data and specifications are in accordance with information available at the time of publication and are subject to change without notice. Vehicles not currently in UK stock and customer order vehicles may take a number of weeks for delivery. Certain combinations of vehicle specifications and factory-fitted options are not compatible and therefore all orders received are subject to confirmation. Models, factory fitted-options and paint and upholstery options are subject to availability. Please check details and availability with an authorised Volkswagen Van Centre at the time of ordering.