



The G-Class

Effective from September 2021 Production.

Mercedes-Benz





Book a test drive



Buy your G-Class



Find a Retailer



Some of the model features, optional extras and colours shown may not be available, or may only be available in a different specification.



Design	Technology & Safety	Model lines	Model prices	Model line wheels, trim & upholstery	Mercedes-AMG	Mercedes-AMG prices	Mercedes-AMG wheels & upholstery	Personalisation	Standard equipment	Genuine accessories	Technical data	Additional information
--------	---------------------	-------------	--------------	--------------------------------------	--------------	---------------------	----------------------------------	-----------------	--------------------	---------------------	----------------	------------------------



Book a test drive



Buy your G-Class



Find a Retailer



Some of the model features, optional extras and colours shown may not be available, or may only be available in a different specification.

Design	Technology & Safety	Model lines	Model prices	Model line wheels, trim & upholstery	Mercedes-AMG	Mercedes-AMG prices	Mercedes-AMG wheels & upholstery	Personalisation	Standard equipment	Genuine accessories	Technical data	Additional information
--------	---------------------	-------------	--------------	--------------------------------------	--------------	---------------------	----------------------------------	-----------------	--------------------	---------------------	----------------	------------------------



Book a test drive



Buy your G-Class



Find a Retailer



G-Class

Technology

Design	Technology & Safety	Model lines	Model prices	Model line wheels, trim & upholstery	Mercedes-AMG	Mercedes-AMG prices	Mercedes-AMG wheels & upholstery	Personalisation	Standard equipment	Genuine accessories	Technical data	Additional information
------------------------	---	-----------------------------	------------------------------	--	------------------------------	-------------------------------------	--	---------------------------------	------------------------------------	-------------------------------------	--------------------------------	--



Book a test drive



Buy your G-Class



Find a Retailer

More is impossible

In off-road terrain the G-Class remains an unrivalled legend. It masters the key off-road disciplines effortlessly and with impressive results, e.g. gradeability, ground clearance, wading depth, angle of approach/departure and lateral slopes.



Front axle

It is executed as a double-wishbone axle with independent suspension and spring strut and ensures the necessary traction in even the most difficult off-road terrain. The new independent suspension enables more precise wheel location, thus in turn enabling better control of the G-Class.



Rear axle

Extremely robust rigid axle with high degree of axial twist supports the chassis and the body. The rigid axle is connected to the ladder frame by means of two lower and two upper trailing arms as well as a panhard rod, which prevents sideways movements in the suspension in terms of between the vehicle body and rigid rear axle, and ensures the necessary traction even in the most difficult terrain and based on the road surface.



Body

The ladder frame has formed the basis for the G-Class since the very beginning. The ladder frame consists of sheet steel of up to 3.4 mm in thickness with closed side members and cross members. This design is considerably more robust and better suited to off-road use than a self-supporting body.

Off-road performance

- Angle of approach/departure: 30.9°/29.9°
- Breakover angle: 25.7°
- Climbing ability: up to 100%
- Ground clearance: 24.1cm
- Maximum fording depth: 70 cm
- Side slope angle: up to 70%

Design	Technology & Safety	Model lines	Model prices	Model line wheels, trim & upholstery	Mercedes-AMG	Mercedes-AMG prices	Mercedes-AMG wheels & upholstery	Personalisation	Standard equipment	Genuine accessories	Technical data	Additional information
--------	---------------------	-------------	--------------	--------------------------------------	--------------	---------------------	----------------------------------	-----------------	--------------------	---------------------	----------------	------------------------



Book a test drive



Buy your G-Class



Find a Retailer

Inside, luxury meets adventure

The G-Class combines timeless design with cutting-edge technology to create an atmosphere that is as relaxing as it is revolutionary.



Smartphone integration¹

Smartphone integration¹ merges the mobile phone with the infotainment system via Apple CarPlay[®] and Android Auto[™]. This gives you convenient access to the most important applications on your smartphone. You can also use apps from third-party service providers such as Spotify quickly and easily.

¹Compatible mobile phone required.



THERMOTRONIC automatic climate control

The THERMOTRONIC automatic climate control system with three climate zones and three climate styles provide an individual feel-good atmosphere on board. The driver and front passenger are able to set the temperature, air distribution and climate style to suit their personal needs. The third climate zone is in the rear - with separately adjustable temperature and airflow.



COMAND Online

Get to your destination faster and in more relaxed style with COMAND Online, the navigation system which is perfectly integrated into the cockpit. Thanks to Live Traffic Information and Car-to-X Communication, you can avoid traffic jams and be made aware of possible sources of danger even earlier, for example.

Design	Technology & Safety	Model lines	Model prices	Model line wheels, trim & upholstery	Mercedes-AMG	Mercedes-AMG prices	Mercedes-AMG wheels & upholstery	Personalisation	Standard equipment	Genuine accessories	Technical data	Additional information
--------	---------------------	-------------	--------------	--------------------------------------	--------------	---------------------	----------------------------------	-----------------	--------------------	---------------------	----------------	------------------------

[Book a test drive](#)[Buy your G-Class](#)[Find a Retailer](#)

Driving Assistance package

The Driving Assistance package contains a range of highly intelligent features to help you stay safe on the road – by making the drive more effortless, by warning of danger, and by taking steps to protect you in an emergency.

Driving Assistance package (code 23P) – designed as a package, including items listed below.

Standard on all models

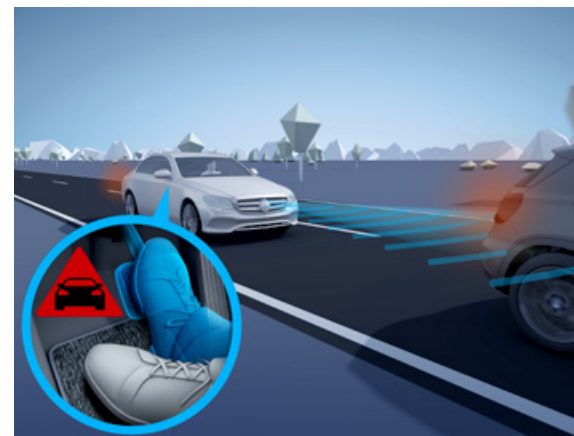
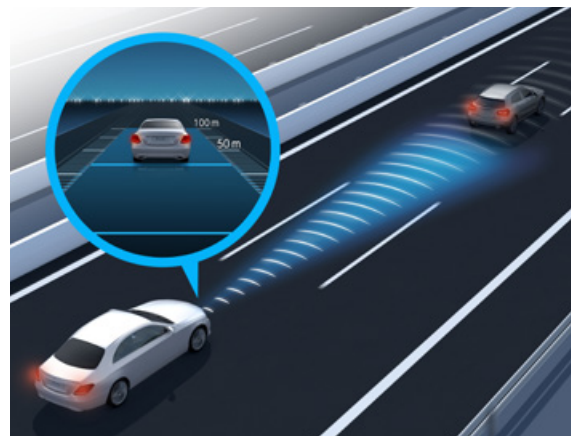

Active Blind Spot Assist can warn the driver of vehicles in the blind spot during a lane change and can help to avoid a collision by means of one-sided braking intervention

Active Braking Assist with cross-traffic function can help to avoid accidents with vehicles ahead, crossing traffic and also pedestrians, and/or mitigate their consequences

Active Distance Assist DISTRONIC helps maintain the desired distance from the vehicle in front

Active Emergency Stop Assist: immediate emergency braking if evasion is impossible

Active Speed Limit Assist ensures detected speed limits are automatically adopted as the set speed for Active Distance Assist DISTRONIC

Active Steering Assist: targeted steering intervention to prevent unintentional drifting out of lane

Evasive Steering Assist can support the driver in making evasive manoeuvres if, in a dangerous situation, he/she moves to avoid any pedestrian detected by the system

PRE-SAFE® PLUS: when a rear-end collision threatens, PRE-SAFE® PLUS can initiate preventive measures, including warning following traffic and locking the brakes on standstill

Route-based speed adjustment: adaption of speed before curves, roundabouts and junctions

Design	Technology & Safety	Model lines	Model prices	Model line wheels, trim & upholstery	Mercedes-AMG	Mercedes-AMG prices	Mercedes-AMG wheels & upholstery	Personalisation	Standard equipment	Genuine accessories	Technical data	Additional information
--------	---------------------	-------------	--------------	--------------------------------------	--------------	---------------------	----------------------------------	-----------------	--------------------	---------------------	----------------	------------------------



Book a test drive



Buy your G-Class



Find a Retailer

G-Class Model lines overview



Edition »



AMG Line Premium »



AMG Line Premium Plus »

Design	Technology & Safety	Model lines	Model prices	Model line wheels, trim & upholstery	Mercedes-AMG	Mercedes-AMG prices	Mercedes-AMG wheels & upholstery	Personalisation	Standard equipment	Genuine accessories	Technical data	Additional information
--------	---------------------	-------------	--------------	--------------------------------------	--------------	---------------------	----------------------------------	-----------------	--------------------	---------------------	----------------	------------------------

G-Class Edition Standard equipment highlights



Exterior

19" AMG alloy wheels – 5-twin-spoke design, painted black

Heat insulating dark tinted glass

MULTIBEAM LED headlamps

Metallic paint

Parking package with 360° camera

Privacy glass

Rear mud flaps

Side running boards

Trailer coupling with ball-type head

Underguard



OTR from **£101,565¹**

¹The recommended on-the-road price includes the Road Fund Licence applicable to the standard model plus delivery charge (£715.00 incl. VAT), new vehicle registration fee (£55.00) and number plates (£25.00 incl. VAT). VAT is calculated at the standard rate of 20%



Interior

Ambient lighting – choice of 8 colour settings

AMG floor mats with 'AMG' lettering

AMG Line leather interior

Heated front and rear seats

KEYLESS-GO starting function

Memory seats, front

Multifunction steering wheel in Nappa leather

THERMOTRONIC three-zone climate control

Velour floor mats

Communications, Safety and Assistance Systems

COMAND Online system with 12.3-inch media display

DAB digital radio tuner

Dual-bonded widescreen cockpit displays (12.3-inch)

Smartphone integration¹ including Apple CarPlay[®] and Android Auto[™]

¹Compatible mobile phone required



Trim and Upholstery

Trim – open pore walnut wood

Upholstery – leather, black

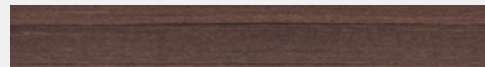

G-Class AMG Line Premium Standard equipment highlights



In addition to/replacement of G-Class Edition:

Exterior

20" AMG alloy wheels – multi-spoke design, painted black with a high-shine finish

AGILITY CONTROL suspension with damping

AMG Line exterior styling

Brake calipers with 'Mercedes-Benz' lettering

Electric sunroof – sliding, with one-touch opening

Heated windscreen



OTR from **£108,065¹**

¹The recommended on-the-road price includes the Road Fund Licence applicable to the standard model plus delivery charge (£715.00 incl. VAT), new vehicle registration fee (£55.00) and number plates (£25.00 incl. VAT). VAT is calculated at the standard rate of 20%

Design	Technology & Safety	Model lines	Model prices	Model line wheels, trim & upholstery	Mercedes-AMG	Mercedes-AMG prices	Mercedes-AMG wheels & upholstery	Personalisation	Standard equipment	Genuine accessories	Technical data	Additional information
--------	---------------------	-------------	--------------	--------------------------------------	--------------	---------------------	----------------------------------	-----------------	--------------------	---------------------	----------------	------------------------



Interior

AMG floor mats with 'AMG' lettering

AMG Line leather interior

Dashboard - leather-covered

Multifunction sports steering wheel in nappa leather
3-spoke design

Communications, Safety and Assistance Systems

Burmester® surround sound system



Trim and Upholstery

Trim - G manufaktur black flamed open-pore ash wood

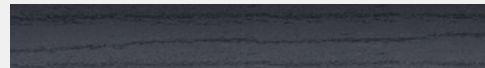

Upholstery - AMG Line leather, black



G-Class AMG Line Premium Plus Standard equipment highlights



In addition to/replacement of
G-Class AMG Line Premium:

Exterior

20" AMG alloy wheels – 5-twin-spoke design, painted high-gloss black with a high-sheen finish



OTR from **£116,065¹**

¹The recommended on-the-road price includes the Road Fund Licence applicable to the standard model plus delivery charge (£715.00 incl. VAT), new vehicle registration fee (£55.00) and number plates (£25.00 incl. VAT). VAT is calculated at the standard rate of 20%

Design	Technology & Safety	Model lines	Model prices	Model line wheels, trim & upholstery	Mercedes-AMG	Mercedes-AMG prices	Mercedes-AMG wheels & upholstery	Personalisation	Standard equipment	Genuine accessories	Technical data	Additional information
--------	---------------------	-------------	--------------	--------------------------------------	--------------	---------------------	----------------------------------	-----------------	--------------------	---------------------	----------------	------------------------



Interior

Ambient lighting – 64 colours

Dashboard in nappa leather

ENERGIZING comfort control

Ionisation of interior air including fine-particle activated charcoal filter system

Roof lining – designo black DINAMICA microfibre

Ventilated multicontour front seats

Trim and Upholstery

Trim – G manufaktur black flamed open-pore ash wood

Upholstery – AMG Line Nappa leather, black

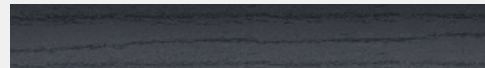

[Book a test drive](#)[Buy your G-Class](#)[Find a Retailer](#)

Model prices

Model line	Engine	Transmission	CO ₂ WLTP ^{1,*}	Basic RRP excl. VAT (£)	Total RRP incl. VAT (£)	Road Fund Licence (£) ² WLTP	Rec. OTR price (£) ³ WLTP	P11D value (£)	BiK tax rate 2021/22 (%) ²
Edition									
G 400 d	Diesel – 2,925 cc, 6-cylinder, 330 hp/243 kW	9G-TRONIC automatic	288	82,104.17	98,525.00	2,245.00	101,565.00	99,265.00	37
AMG Line Premium									
G 400 d	Diesel – 2,925 cc, 6-cylinder, 330 hp/243 kW	9G-TRONIC automatic	289	87,520.83	105,025.00	2,245.00	108,065.00	105,765.00	37
AMG Line Premium Plus									
G 400 d	Diesel – 2,925 cc, 6-cylinder, 330 hp/243 kW	9G-TRONIC automatic	290	94,187.50	113,025.00	2,245.00	116,065.00	113,765.00	37

¹The indicated values were determined according to the prescribed measurement method - Worldwide Harmonised Light Vehicle Test Procedure (WLTP). Figures shown may include options which are not available in the UK. ²Figures shown are for comparability purposes; only compare with other cars tested to the same technical procedures. Figures may not reflect real life driving results, which will depend upon a number of factors including factory-fitted options, accessories fitted (post registration), variations in weather, driving styles and vehicle load. Further information about the test used to establish fuel consumption and CO₂ figures can be found at <http://www.mercedes-benz.co.uk/WLTP> ³A different first year rate of Vehicle Excise Duty (Road Fund Licence) applies for new cars. Please refer to page 59 for the relevant rate for the second and subsequent years ⁴The recommended on-the-road price includes the Road Fund Licence applicable to the standard model plus delivery charge (£715.00 incl.VAT), new vehicle registration fee (£55.00) and number plates (£25.00 incl.VAT). VAT is calculated at the standard rate of 20%



Book a test drive



Buy your G-Class



Find a Retailer

Wheels

● Standard □ No-cost option - Not available



RJ4 19" alloy wheels - 5-twin-spoke design, painted black, 275/55 R19 tyres

Edition	●
AMG Line Premium	-
AMG Line Premium Plus	-



RG6 20" AMG alloy wheels - multi-spoke design, painted high-gloss black with a high-sheen finish, 275/50 R20 tyres

Edition	-
AMG Line Premium	●
AMG Line Premium Plus	-



R16 20" AMG alloy wheels - 5-twin-spoke design, painted high-gloss black with a high-sheen finish, 275/50 R20 tyres

Edition	-
AMG Line Premium	-
AMG Line Premium Plus	●



RK4 20" AMG alloy wheels - multi-spoke design, painted titanium grey with a high-sheen finish, 275/50 R20 tyres

Edition	-
AMG Line Premium	□
AMG Line Premium Plus	-



R17 20" AMG alloy wheels - 5-twin-spoke design, painted himalayas grey with a high-sheen finish, 275/50 R20 tyres

Edition	-
AMG Line Premium	-
AMG Line Premium Plus	□

Trim

Standard
 No-cost option
 Optional
 Not available



VA2 open pore walnut wood

Edition	<input checked="" type="checkbox"/>
AMG Line Premium	<input type="checkbox"/>
AMG Line Premium Plus	<input type="checkbox"/>
Total RRP incl. VAT	-



ZG2 designo black piano lacquer

Edition	<input type="checkbox"/>
AMG Line Premium	<input type="checkbox"/>
AMG Line Premium Plus	<input type="checkbox"/>
Total RRP incl. VAT	£640.00



VA1 G manufaktur black flamed open-pore ash wood

Edition	<input type="checkbox"/>
AMG Line Premium	<input checked="" type="checkbox"/>
AMG Line Premium Plus	<input checked="" type="checkbox"/>
Total RRP incl. VAT	-

Upholstery

● Standard □ No-cost option - Not available



201A black leather¹

Edition	●
AMG Line Premium	●
AMG Line Premium Plus	-
Total RRP incl. VAT	-



214A nut brown/black leather^{1,3}

Edition	□
AMG Line Premium	□
AMG Line Premium Plus	-
Total RRP incl. VAT	-



215A macchiato beige/black leather¹

Edition	□
AMG Line Premium	□
AMG Line Premium Plus	-
Total RRP incl. VAT	-



501A black nappa leather^{2,4}

Edition	-
AMG Line Premium	-
AMG Line Premium Plus	●
Total RRP incl. VAT	-

¹At least 80% of the seat upholstery is pure leather, while up to 20% may consist of man-made leather

²100% of upholstery is pure leather

³Not available with rubellite red paint (code 660)

⁴GM1/SR1 upholsterys available at no additional cost. Please see G-Manufaktur package for more details



Book a test drive



Buy your G-Class



Find a Retailer



AMG



G-Class

Mercedes-AMG

Design	Technology & Safety	Model lines	Model prices	Model line wheels, trim & upholstery	Mercedes-AMG	Mercedes-AMG prices	Mercedes-AMG wheels & upholstery	Personalisation	Standard equipment	Genuine accessories	Technical data	Additional information
--------	---------------------	-------------	--------------	--------------------------------------	--------------	---------------------	----------------------------------	-----------------	--------------------	---------------------	----------------	------------------------



Book a test drive



Buy your G-Class



Find a Retailer

Mercedes-AMG G-Class Model lines overview



Mercedes-AMG G 63 »



Mercedes-AMG G 63 Magno Edition »

Design	Technology & Safety	Model lines	Model prices	Model line wheels, trim & upholstery	Mercedes-AMG	Mercedes-AMG prices	Mercedes-AMG wheels & upholstery	Personalisation	Standard equipment	Genuine accessories	Technical data	Additional information
--------	---------------------	-------------	--------------	--------------------------------------	--------------	---------------------	----------------------------------	-----------------	--------------------	---------------------	----------------	------------------------

Mercedes-AMG G 63 Standard equipment highlights



Option shown: periclas green metallic (code 300)



Option shown: periclas green metallic (code 300)

Engine, Transmission and Suspension

AMG RIDE CONTROL suspension with DYNAMIC SELECT

Exterior

22" AMG forged wheels – cross-spoke design, painted matt black with a high-sheen rim flange

AMG red brake callipers

AMG-specific radiator grille

AMG sports exhaust system with chrome-trimmed twin tailpipes

Electric sunroof – sliding, with one-touch opening

Heated windscreen

Metallic paint

MULTIBEAM LED headlamps with Adaptive Highbeam Assist Plus

Privacy glass

Parking package with 360° camera

Side running boards

Stainless steel package

Stainless steel spare wheel cover

Trailer coupling with ball-type head

Underguard



OTR from **£154,065¹**

¹The recommended on-the-road price includes the Road Fund Licence applicable to the standard model plus delivery charge (£715.00 incl. VAT), new vehicle registration fee (£55.00) and number plates (£25.00 incl. VAT). VAT is calculated at the standard rate of 20%

Design	Technology & Safety	Model lines	Model prices	Model line wheels, trim & upholstery	Mercedes-AMG	Mercedes-AMG prices	Mercedes-AMG wheels & upholstery	Personalisation	Standard equipment	Genuine accessories	Technical data	Additional information
--------	---------------------	-------------	--------------	--------------------------------------	--------------	---------------------	----------------------------------	-----------------	--------------------	---------------------	----------------	------------------------



No-cost option shown: Exclusive Nappa leather platinum white/black (code 953A + GM1)

Interior

Active Multicontour Seat package	Dashboard – leather trimmed
Ambient lighting – choice of 64 colour settings	DINAMICA roof liner
AMG floor mats with 'AMG' lettering	ENERGIZING comfort control
AMG Performance steering wheel in Nappa leather	Illuminated AMG door sill panels with 'AMG' lettering at front and rear
AMG-specific IWC-design analogue clock	Ionisation of interior air
AMG sports seats in AMG Nappa leather	
AMG steering wheel buttons	

Communications, Safety and Assistance Systems

AMG dual bonded widescreen cockpit displays (12.3-inch)	Driving Assistance package
Burmester® surround sound system	Smartphone integration ¹ including Apple CarPlay® and Android Auto™
COMAND Online system with 12.3-inch media display	
DAB digital radio tuner	¹ Compatible mobile phone required



No-cost option shown: Exclusive Nappa leather platinum white/black (code 953A + GM1)

Trim and Upholstery

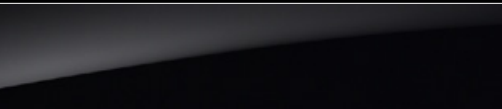
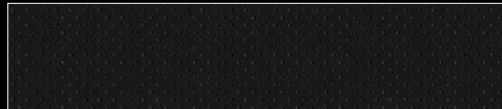
Trim – G manufaktur black piano lacquer	Upholstery – AMG Nappa leather, black
	

Mercedes-AMG G 63 Magno Edition Standard equipment highlights



OTR from **£171,715¹**

In addition to/replacement of Mercedes-AMG G 63:

Exterior

AMG Night package II, including typography & Mercedes star at front and rear, in high-gloss black

AMG Night package magno

Bumpers and wheel arch flaring in night black magno

Magno paint

¹The recommended on-the-road price includes the Road Fund Licence applicable to the standard model plus delivery charge (£715.00 incl. VAT), new vehicle registration fee (£55.00) and number plates (£25.00 incl. VAT). VAT is calculated at the standard rate of 20%

Design	Technology & Safety	Model lines	Model prices	Model line wheels, trim & upholstery	Mercedes-AMG	Mercedes-AMG prices	Mercedes-AMG wheels & upholstery	Personalisation	Standard equipment	Genuine accessories	Technical data	Additional information
--------	---------------------	-------------	--------------	--------------------------------------	--------------	---------------------	----------------------------------	-----------------	--------------------	---------------------	----------------	------------------------



No-cost option shown: G manufaktur titanium grey pearl/black (code 958A + GM2)

Interior

AMG performance steering wheel in carbon fibre/
DINAMICA microfibre

AMG Exclusive Nappa leather upholstery

Dashboard in nappa leather



Trim and Upholstery

Trim - AMG carbon fibre

Upholstery - AMG Exclusive Nappa leather, black

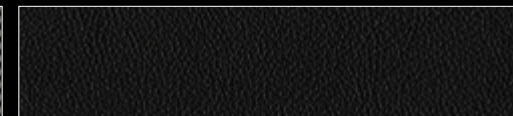



Book a test drive



Buy your G-Class



Find a Retailer

Become the AMG expert

Unleash a new level of performance.



Step into the world of performance and experience the AMG brand at Mercedes-Benz World – from the powerful sound of the engines to the smell of the leather to the unmistakable design of our vehicles.

Mercedes-Benz World invites all Mercedes-AMG customers to a complimentary adrenaline-packed driving experience. Feel the sensational AMG driving performance, develop your driving skills and even try your hand at power-sliding on the Wet Skid Circle. With expert one-to-one guidance from a Driving Specialist in the passenger seat, experience every inch of our Handling Circuits, Dynamic Straight and low friction surfaces.

[Click here for more information](#)



TERMS AND CONDITIONS

The following customers only are eligible: The first purchaser/registered keeper of a newly registered Mercedes-AMG. The complimentary Training must be booked and taken within 12 months of delivery of your Mercedes-AMG, the Training is offered on specific days only and subject to availability. Upgrades are available for an additional cost, details upon request. Transferable to individuals who reside at the same postal address only. Mercedes-Benz Cars UK Limited reserves the right to amend or withdraw this Training experience. Attendees must hold a full UK driving licence. Attendees will be required to sign the Mercedes-Benz World Driving Risk Acknowledgement prior to undertaking the Training experience. The Training experience is also subject to the Mercedes-Benz World Terms and Conditions, as applicable. Invitation is emailed to the customer post-delivery, permission via the customer contact preferences must be given to enable Mercedes-Benz World to contact. Retailer demonstrator vehicles are not eligible.

Design	Technology & Safety	Model lines	Model prices	Model line wheels, trim & upholstery	Mercedes-AMG	Mercedes-AMG prices	Mercedes-AMG wheels & upholstery	Personalisation	Standard equipment	Genuine accessories	Technical data	Additional information
--------	---------------------	-------------	--------------	--------------------------------------	--------------	---------------------	----------------------------------	-----------------	--------------------	---------------------	----------------	------------------------

[Book a test drive](#)[Buy your G-Class](#)[Find a Retailer](#)

Mercedes-AMG prices



Model line	Engine	Transmission	CO ₂ WLTP ^{1,*}	Basic RRP excl. VAT (£)	Total RRP incl. VAT (£)	Road Fund Licence (£) ² WLTP	Rec. OTR price (£) ³ WLTP	P11D value (£)	BiK tax rate 2020/21 (%) ²
Mercedes-AMG									
Mercedes-AMG G 63 4MATIC	Petrol – 3,982cc, 8-cylinder, 585 hp/430 kW	AMG SPEEDSHIFT PLUS 9G-TRONIC	373	125,854.17	151,025.00	2,245.00	154,065.00	151,765.00	37
Mercedes-AMG Magno Edition									
Mercedes-AMG G 63 4MATIC	Petrol – 3,982cc, 8-cylinder, 585 hp/430 kW	AMG SPEEDSHIFT PLUS 9G-TRONIC	373	140,562.50	168,675.00	2,245.00	171,715.00	169,415.00	37

¹The indicated values were determined according to the prescribed measurement method - Worldwide Harmonised Light Vehicle Test Procedure (WLTP). Figures shown may include options which are not available in the UK. ²Figures shown are for comparability purposes; only compare with other cars tested to the same technical procedures. Figures may not reflect real life driving results, which will depend upon a number of factors including factory-fitted options, accessories fitted (post registration), variations in weather, driving styles and vehicle load. Further information about the test used to establish fuel consumption and CO₂ figures can be found at <http://www.mercedes-benz.co.uk/WLTP> ³A different first year rate of Vehicle Excise Duty (Road Fund Licence) applies for new cars. Please refer to page 59 for the relevant rate for the second and subsequent years ⁴The recommended on-the-road price includes the Road Fund Licence applicable to the standard model plus delivery charge (£715.00 incl.VAT), new vehicle registration fee (£55.00) and number plates (£25.00 incl.VAT). VAT is calculated at the standard rate of 20%

Design	Technology & Safety	Model lines	Model prices	Model line wheels, trim & upholstery	Mercedes-AMG	Mercedes-AMG prices	Mercedes-AMG wheels & upholstery	Personalisation	Standard equipment	Genuine accessories	Technical data	Additional information
--------	---------------------	-------------	--------------	--------------------------------------	--------------	---------------------	----------------------------------	-----------------	--------------------	---------------------	----------------	------------------------



Book a test drive



Buy your G-Class



Find a Retailer

Mercedes-AMG wheels



- Standard
- No-cost option



RG4 22" AMG forged wheels – cross-spoke design, painted matt black with a high-shine rim flange, 295/40 R22 tyres

Mercedes-AMG G 63



Mercedes-AMG G 63 Magno Edition



RG5 22" AMG forged wheels – cross-spoke design, painted titanium grey with a high-shine finish, 295/40 R22 tyres

Mercedes-AMG G 63



Mercedes-AMG G 63 Magno Edition



Design	Technology & Safety	Model lines	Model prices	Model line wheels, trim & upholstery	Mercedes-AMG	Mercedes-AMG prices	Mercedes-AMG wheels & upholstery	Personalisation	Standard equipment	Genuine accessories	Technical data	Additional information
--------	---------------------	-------------	--------------	--------------------------------------	--------------	---------------------	----------------------------------	-----------------	--------------------	---------------------	----------------	------------------------

Mercedes-AMG upholstery



● Standard □ No-cost option - Not available



501A AMG nappa leather¹ - black

Mercedes-AMG G 63	●
Mercedes-AMG G 63 Magno Edition	□
Total RRP incl. VAT	-



507A AMG nappa leather¹ - classic red/black

Mercedes-AMG G 63	□
Mercedes-AMG G 63 Magno Edition	□
Total RRP incl. VAT	-



525A AMG nappa leather¹ - truffle brown/black

Mercedes-AMG G 63	□
Mercedes-AMG G 63 Magno Edition	□
Total RRP incl. VAT	-



535A AMG nappa leather¹ - macchiato beige/black

Mercedes-AMG G 63	□
Mercedes-AMG G 63 Magno Edition	□
Total RRP incl. VAT	-



801A AMG Exclusive Nappa leather¹ - black

Mercedes-AMG G 63 ²	□
Mercedes-AMG G 63 Magno Edition ³	●
Total RRP incl. VAT	-

¹100% of upholstery is pure leather ²Only in conjunction with optional G Manufaktur package ³All G-Manufaktur upholsterys available at no cost. Please see G-Manufaktur package for more details

Design	Technology & Safety	Model lines	Model prices	Model line wheels, trim & upholstery	Mercedes-AMG	Mercedes-AMG prices	Mercedes-AMG wheels & upholstery	Personalisation	Standard equipment	Genuine accessories	Technical data	Additional information
--------	---------------------	-------------	--------------	--------------------------------------	--------------	---------------------	----------------------------------	-----------------	--------------------	---------------------	----------------	------------------------

[Book a test drive](#)[Buy your G-Class](#)[Find a Retailer](#)

Colour options Non-metallic and metallic paint

● Standard □ No-cost option – Not available



149 polar white non-metallic	
Edition	●
AMG Line Premium	●
AMG Line Premium Plus	●
Mercedes-AMG G 63	●
Mercedes-AMG G 63 Magno Edition	–



660 rubellite red metallic ¹	
Edition	□
AMG Line Premium	□
AMG Line Premium Plus	□
Mercedes-AMG G 63	□
Mercedes-AMG G 63 Magno Edition	–



859 mojave silver metallic	
Edition	□
AMG Line Premium	□
AMG Line Premium Plus	□
Mercedes-AMG G 63	□
Mercedes-AMG G 63 Magno Edition	–



896 brilliant blue metallic	
Edition	□
AMG Line Premium	□
AMG Line Premium Plus	□
Mercedes-AMG G 63	□
Mercedes-AMG G 63 Magno Edition	–



992 selenite grey metallic	
Edition	□
AMG Line Premium	□
AMG Line Premium Plus	□
Mercedes-AMG G 63	□
Mercedes-AMG G 63 Magno Edition	–



197 obsidian black metallic	
Edition	□
AMG Line Premium	□
AMG Line Premium Plus	□
Mercedes-AMG G 63	□
Mercedes-AMG G 63 Magno Edition	–



775 iridium silver metallic	
Edition	□
AMG Line Premium	□
AMG Line Premium Plus	□
Mercedes-AMG G 63	□
Mercedes-AMG G 63 Magno Edition	–



890 cavansite blue metallic	
Edition	□
AMG Line Premium	□
AMG Line Premium Plus	□
Mercedes-AMG G 63	□
Mercedes-AMG G 63 Magno Edition	–



989 emerald green metallic	
Edition	□
AMG Line Premium	□
AMG Line Premium Plus	□
Mercedes-AMG G 63	□
Mercedes-AMG G 63 Magno Edition	–

¹Not available with leather nut brown/black (code 214A)



G manufaktur

G-Class

G Manufaktur package



Book a test drive



Buy your G-Class



Find a Retailer

G Manufaktur package

The G Manufaktur package offers a wealth of paint and upholstery combinations, enhancing the individualisation of the iconic G-Class.

G Manufaktur package (code DPM) – designed and priced as a package.

AMG Line Premium Plus and Mercedes-AMG G 63 only Total incl. VAT £7,995.00

Selecting Magno paint will replace Night package with Night package Magno.
Standard for Mercedes-AMG G63 Magno Edition.



026 sea blue metallic



923A+GM2 Nappa leather platinum white/black

Design	Technology & Safety	Model lines	Model prices	Model line wheels, trim & upholstery	Mercedes-AMG	Mercedes-AMG prices	Mercedes-AMG wheels & upholstery	Personalisation	Standard equipment	Genuine accessories	Technical data	Additional information
--------	---------------------	-------------	--------------	--------------------------------------	--------------	---------------------	----------------------------------	-----------------	--------------------	---------------------	----------------	------------------------

[Book a test drive](#)[Buy your G-Class](#)[Find a Retailer](#)

G Manufaktur package Colour options

No-cost option Not available



026 sea blue metallic	
Edition	–
AMG Line Premium	–
AMG Line Premium Plus	<input type="checkbox"/>
Mercedes-AMG G 63	<input type="checkbox"/>
Mercedes-AMG G 63 Magno Edition	–



041 graphite metallic	
Edition	–
AMG Line Premium	–
AMG Line Premium Plus	<input type="checkbox"/>
Mercedes-AMG G 63	<input type="checkbox"/>
Mercedes-AMG G 63 Magno Edition	–



124 classic grey solid	
Edition	–
AMG Line Premium	–
AMG Line Premium Plus	<input type="checkbox"/>
Mercedes-AMG G 63	<input type="checkbox"/>
Mercedes-AMG G 63 Magno Edition	–



255 olive metallic	
Edition	–
AMG Line Premium	–
AMG Line Premium Plus	<input type="checkbox"/>
Mercedes-AMG G 63	<input type="checkbox"/>
Mercedes-AMG G 63 Magno Edition	–



464 desert sand non-metallic	
Edition	–
AMG Line Premium	–
AMG Line Premium Plus	<input type="checkbox"/>
Mercedes-AMG G 63	<input type="checkbox"/>
Mercedes-AMG G 63 Magno Edition	–



032 mystic blue bright	
Edition	–
AMG Line Premium	–
AMG Line Premium Plus	<input type="checkbox"/>
Mercedes-AMG G 63	<input type="checkbox"/>
Mercedes-AMG G 63 Magno Edition	–



052 mystic brown bright	
Edition	–
AMG Line Premium	–
AMG Line Premium Plus	<input type="checkbox"/>
Mercedes-AMG G 63	<input type="checkbox"/>
Mercedes-AMG G 63 Magno Edition	–



162 south seas blue metallic	
Edition	–
AMG Line Premium	–
AMG Line Premium Plus	<input type="checkbox"/>
Mercedes-AMG G 63	<input type="checkbox"/>
Mercedes-AMG G 63 Magno Edition	–



300 periclae green metallic	
Edition	–
AMG Line Premium	–
AMG Line Premium Plus	<input type="checkbox"/>
Mercedes-AMG G 63	<input type="checkbox"/>
Mercedes-AMG G 63 Magno Edition	–



589 jupiter red non-metallic	
Edition	–
AMG Line Premium	–
AMG Line Premium Plus	<input type="checkbox"/>
Mercedes-AMG G 63	<input type="checkbox"/>
Mercedes-AMG G 63 Magno Edition	–

[Book a test drive](#)[Buy your G-Class](#)[Find a Retailer](#)

G Manufaktur package Colour options

No-cost option Not available



693 travertine beige metallic	
Edition	–
AMG Line Premium	–
AMG Line Premium Plus	<input type="checkbox"/>
Mercedes-AMG G 63	<input type="checkbox"/>
Mercedes-AMG G 63 Magno Edition	–



825 deep green solid	
Edition	–
AMG Line Premium	–
AMG Line Premium Plus	<input type="checkbox"/>
Mercedes-AMG G 63	<input type="checkbox"/>
Mercedes-AMG G 63 Magno Edition	–



904 dark blue non-metallic	
Edition	–
AMG Line Premium	–
AMG Line Premium Plus	<input type="checkbox"/>
Mercedes-AMG G 63	<input type="checkbox"/>
Mercedes-AMG G 63 Magno Edition	–



963 indium grey metallic	
Edition	–
AMG Line Premium	–
AMG Line Premium Plus	<input type="checkbox"/>
Mercedes-AMG G 63	<input type="checkbox"/>
Mercedes-AMG G 63 Magno Edition	–



796 citrine brown metallic	
Edition	–
AMG Line Premium	–
AMG Line Premium Plus	<input type="checkbox"/>
Mercedes-AMG G 63	<input type="checkbox"/>
Mercedes-AMG G 63 Magno Edition	–



885 opalite white bright	
Edition	–
AMG Line Premium	–
AMG Line Premium Plus	<input type="checkbox"/>
Mercedes-AMG G 63	<input type="checkbox"/>
Mercedes-AMG G 63 Magno Edition	–



934 china blue solid	
Edition	–
AMG Line Premium	–
AMG Line Premium Plus	<input type="checkbox"/>
Mercedes-AMG G 63	<input type="checkbox"/>
Mercedes-AMG G 63 Magno Edition	–



996 hyacinth red metallic	
Edition	–
AMG Line Premium	–
AMG Line Premium Plus	<input type="checkbox"/>
Mercedes-AMG G 63	<input type="checkbox"/>
Mercedes-AMG G 63 Magno Edition	–

[Book a test drive](#)[Buy your G-Class](#)[Find a Retailer](#)

G Manufaktur package Colour options

● Standard □ No-cost option – Not available



051 platinum magno	
Edition	–
AMG Line Premium	–
AMG Line Premium Plus	□
Mercedes-AMG G 63	□
Mercedes-AMG G 63 Magno Edition	□



056 night black magno	
Edition	–
AMG Line Premium	–
AMG Line Premium Plus	□
Mercedes-AMG G 63	□
Mercedes-AMG G 63 Magno Edition	□



271 citrine brown magno	
Edition	–
AMG Line Premium	–
AMG Line Premium Plus	□
Mercedes-AMG G 63	□
Mercedes-AMG G 63 Magno Edition	□



054 monza grey magno	
Edition	–
AMG Line Premium	–
AMG Line Premium Plus	□
Mercedes-AMG G 63	□
Mercedes-AMG G 63 Magno Edition	●



164 dark olive magno	
Edition	–
AMG Line Premium	–
AMG Line Premium Plus	□
Mercedes-AMG G 63	□
Mercedes-AMG G 63 Magno Edition	□



795 manganite grey magno	
Edition	–
AMG Line Premium	–
AMG Line Premium Plus	□
Mercedes-AMG G 63	□
Mercedes-AMG G 63 Magno Edition	□



Book a test drive



Buy your G-Class



Find a Retailer

G Manufaktur package Upholstery options (AMG Line Premium Plus)



907A+GM1 Nappa leather black with red topstitching



902A+GM1 Nappa leather black with yacht blue topstitching



903A+GM1 Nappa leather black with white topstitching



953A+GM1 Nappa leather platinum white/black



909A+GM1 Nappa leather black with gold topstitching



906A+GM1 Nappa leather black with lime green topstitching



952A+GM1 Nappa leather yacht blue/black

GM1 upholsteries available at no cost

Design	Technology & Safety	Model lines	Model prices	Model line wheels, trim & upholstery	Mercedes-AMG	Mercedes-AMG prices	Mercedes-AMG wheels & upholstery	Personalisation	Standard equipment	Genuine accessories	Technical data	Additional information
--------	---------------------	-------------	--------------	--------------------------------------	--------------	---------------------	----------------------------------	-----------------	--------------------	---------------------	----------------	------------------------



Book a test drive



Buy your G-Class



Find a Retailer

G Manufaktur package Upholstery options (AMG Line Premium Plus)



954A+GM1 Nappa leather espresso brown/black



958A+GM1 Nappa leather titanium grey/black



801A+SR2 Exclusive Nappa leather black



907A+GM2 Exclusive Nappa leather black with red topstitching



909A+GM2 Exclusive Nappa leather black with gold topstitching



957A+GM1 Nappa leather bengal red/black



964A+GM1 Nappa leather saddle brown/black



805A+SR2 Exclusive Nappa leather macchiato beige/espresso brown



902A+GM2 Exclusive Nappa leather black with yacht blue topstitching



903A+GM2 Exclusive Nappa leather black with white topstitching

GM1 upholsteries available at no cost

Design	Technology & Safety	Model lines	Model prices	Model line wheels, trim & upholstery	Mercedes-AMG	Mercedes-AMG prices	Mercedes-AMG wheels & upholstery	Personalisation	Standard equipment	Genuine accessories	Technical data	Additional information
--------	---------------------	-------------	--------------	--------------------------------------	--------------	---------------------	----------------------------------	-----------------	--------------------	---------------------	----------------	------------------------



Book a test drive



Buy your G-Class



Find a Retailer

G Manufaktur package Upholstery options (AMG Line Premium Plus)



906A+GM2 Exclusive Nappa leather black with lime green topstitching



922A+GM2 Exclusive Nappa leather yacht blue



924A+GM2 Exclusive Nappa leather espresso brown



934A+GM2 Exclusive Nappa leather saddle brown



912A+GM2 Exclusive Nappa leather black with yacht blue A-band



923A+GM2 Exclusive Nappa leather platinum white/black



927A+GM2 Exclusive Nappa leather bengal red



928A+GM2 Exclusive Nappa leather titanium grey pearl



913A+GM2 Exclusive Nappa leather platinum white with black A-band



916A+GM2 Exclusive Nappa leather black with lime green A-band



Book a test drive



Buy your G-Class



Find a Retailer

G Manufaktur package Upholstery options (AMG Line Premium Plus)



914A+GM2 Exclusive Nappa leather saddle brow with black A-band



953A+GM2 Exclusive Nappa leather platinum white/black



954A+GM2 Exclusive Nappa leather espresso brown/black



958A+GM2 Exclusive Nappa leather titanium grey/black



917A+GM2 Exclusive Nappa leather black with bengal red A-band



952A+GM2 Exclusive Nappa leather yacht blue/black



957A+GM2 Exclusive Nappa leather bengal red/black



964A+GM2 Exclusive Nappa leather saddle brown/black

Design	Technology & Safety	Model lines	Model prices	Model line wheels, trim & upholstery	Mercedes-AMG	Mercedes-AMG prices	Mercedes-AMG wheels & upholstery	Personalisation	Standard equipment	Genuine accessories	Technical data	Additional information
--------	---------------------	-------------	--------------	--------------------------------------	--------------	---------------------	----------------------------------	-----------------	--------------------	---------------------	----------------	------------------------



Book a test drive



Buy your G-Class



Find a Retailer

G Manufaktur package Upholstery options (Mercedes-AMG G 63)



907A+GM1 Nappa leather black with red topstitching



902A+GM1 Nappa leather black with yacht blue topstitching



903A+GM1 Nappa leather black with white topstitching



953A+GM1 Nappa leather platinum white/black



909A+GM1 Nappa leather black with gold topstitching



906A+GM1 Nappa leather black with lime green topstitching



952A+GM1 Nappa leather yacht blue/black

GM1 upholsteries available at no cost

Design	Technology & Safety	Model lines	Model prices	Model line wheels, trim & upholstery	Mercedes-AMG	Mercedes-AMG prices	Mercedes-AMG wheels & upholstery	Personalisation	Standard equipment	Genuine accessories	Technical data	Additional information
--------	---------------------	-------------	--------------	--------------------------------------	--------------	---------------------	----------------------------------	-----------------	--------------------	---------------------	----------------	------------------------



Book a test drive



Buy your G-Class



Find a Retailer

G Manufaktur package Upholstery options (Mercedes-AMG G 63)



954A+GM1 Nappa leather espresso brown/black



958A+GM1 Nappa leather titanium grey/black



922A+GM1 Nappa leather yacht blue/black



924A+GM1 Nappa leather espresso brown



928A+GM1 Nappa leather titanium grey pearl/black



957A+GM1 Nappa leather bengal red/black



964A+GM1 Nappa leather saddle brown/black



923A+GM1 Nappa leather platinum white/black



927A+GM1 Nappa leather bengal red



934A+GM1 Nappa leather saddle brown

GM1 upholsteries available at no cost

Design	Technology & Safety	Model lines	Model prices	Model line wheels, trim & upholstery	Mercedes-AMG	Mercedes-AMG prices	Mercedes-AMG wheels & upholstery	Personalisation	Standard equipment	Genuine accessories	Technical data	Additional information
--------	---------------------	-------------	--------------	--------------------------------------	--------------	---------------------	----------------------------------	-----------------	--------------------	---------------------	----------------	------------------------

G Manufaktur package Upholstery options (Mercedes-AMG G 63)



912A+GM1 Nappa leather black with yacht blue A-band



914A+GM1 Nappa leather saddle brown with black A-band



917A+GM1 Nappa leather black with bengal red A-band



805A+SR2 Exclusive Nappa leather macchiato beige/espresso brown¹



807A+SR2 Exclusive Nappa leather classic red/black¹



907A+GM2 Exclusive Nappa leather black with red topstitching



913A+GM1 Nappa leather platinum white with black A-band



916A+GM1 Nappa leather black with lime green A-band



801A+SR2 Exclusive Nappa leather black



902A+GM2 Exclusive Nappa leather black with yacht blue topstitching

GM1 upholsteries available at no cost ¹805A/807A not available on Mercedes-AMG G 63 Magno Edition

Design	Technology & Safety	Model lines	Model prices	Model line wheels, trim & upholstery	Mercedes-AMG	Mercedes-AMG prices	Mercedes-AMG wheels & upholstery	Personalisation	Standard equipment	Genuine accessories	Technical data	Additional information
--------	---------------------	-------------	--------------	--------------------------------------	--------------	---------------------	----------------------------------	-----------------	--------------------	---------------------	----------------	------------------------



Book a test drive



Buy your G-Class



Find a Retailer

G Manufaktur package Upholstery options (Mercedes-AMG G 63)



909A+GM2 Exclusive Nappa leather black with gold topstitching



906A+GM2 Exclusive Nappa leather black with lime green topstitching



922A+GM2 Exclusive Nappa leather yacht blue



924A+GM2 Exclusive Nappa leather espresso brown



934A+GM2 Exclusive Nappa leather saddle brown



912A+GM2 Exclusive Nappa leather black with yacht blue A-band



923A+GM2 Exclusive Nappa leather platinum white/black



927A+GM2 Exclusive Nappa leather bengal red



928A+GM2 Exclusive Nappa leather titanium grey pearl



913A+GM2 Exclusive Nappa leather platinum white with black A-band

Design	Technology & Safety	Model lines	Model prices	Model line wheels, trim & upholstery	Mercedes-AMG	Mercedes-AMG prices	Mercedes-AMG wheels & upholstery	Personalisation	Standard equipment	Genuine accessories	Technical data	Additional information
--------	---------------------	-------------	--------------	--------------------------------------	--------------	---------------------	----------------------------------	-----------------	--------------------	---------------------	----------------	------------------------



Book a test drive



Buy your G-Class



Find a Retailer

G Manufaktur package Upholstery options (Mercedes-AMG G 63)



916A+GM2 Exclusive Nappa leather black with lime green A-band



914A+GM2 Exclusive Nappa leather saddle brown with black A-band



953A+GM2 Exclusive Nappa leather platinum white/black



954A+GM2 Exclusive Nappa leather espresso brown/black



958A+GM2 Exclusive Nappa leather titanium grey/black



917A+GM2 Exclusive Nappa leather black with bengal red A-band



952A+GM2 Exclusive Nappa leather yacht blue/black



957A+GM2 Exclusive Nappa leather bengal red/black



964A+GM2 Exclusive Nappa leather saddle brown/black

Design	Technology & Safety	Model lines	Model prices	Model line wheels, trim & upholstery	Mercedes-AMG	Mercedes-AMG prices	Mercedes-AMG wheels & upholstery	Personalisation	Standard equipment	Genuine accessories	Technical data	Additional information
--------	---------------------	-------------	--------------	--------------------------------------	--------------	---------------------	----------------------------------	-----------------	--------------------	---------------------	----------------	------------------------

[Book a test drive](#)[Buy your G-Class](#)[Find a Retailer](#)

Rear Seat Entertainment package

Films, internet, video games or music: the Rear Seat Entertainment System, with a variety of interfaces for external media, ensures nobody gets bored. The two 10-inch touchscreens installed on the backrest boast brilliant picture quality. Pre-installation for the Rear Seat Entertainment system and well as a TV tuner form part of this package.

Rear Seat Entertainment package (code DP3) – designed and priced as a package.

AMG Line Premium, AMG Line Premium Plus and Mercedes-AMG G 63

Total incl. VAT £3,495.00

Not available for G400 d Edition

Consisting of:

Digital TV tuner (front screen only – does not display in rear)

Internet access via browser and email client possible

Integral media player for playback of a variety of media

Two touchscreen displays with 10-inch screen diagonal for brilliant picture quality

USB 2.0, AUX and HDMI interfaces for the integration of smartphone content, laptop content or games consoles (SD memory cards via adapter)

Please note headphones are not included in this package. Any Bluetooth® headphone will, however, work with this system.



Design	Technology & Safety	Model lines	Model prices	Model line wheels, trim & upholstery	Mercedes-AMG	Mercedes-AMG prices	Mercedes-AMG wheels & upholstery	Personalisation	Standard equipment	Genuine accessories	Technical data	Additional information
--------	---------------------	-------------	--------------	--------------------------------------	--------------	---------------------	----------------------------------	-----------------	--------------------	---------------------	----------------	------------------------

[Book a test drive](#)[Buy your G-Class](#)[Find a Retailer](#)

AMG Driver's package

The AMG Drive's package offers an even sportier driving experience by increasing the top speed to 150 mph.

AMG Driver's package (code Z10) – designed and priced as a package.
**Mercedes-AMG G 63 and
Mercedes-AMG G 63 Magno Edition only**

Total incl. VAT £1,995.00



Design	Technology & Safety	Model lines	Model prices	Model line wheels, trim & upholstery	Mercedes-AMG	Mercedes-AMG prices	Mercedes-AMG wheels & upholstery	Personalisation	Standard equipment	Genuine accessories	Technical data	Additional information
--------	---------------------	-------------	--------------	--------------------------------------	--------------	---------------------	----------------------------------	-----------------	--------------------	---------------------	----------------	------------------------

[Book a test drive](#)[Buy your G-Class](#)[Find a Retailer](#)

Night package

Add the Night package to your G 400 d to create an even bolder look. Heat-insulating dark-tinted glass in combination with the exterior mirrors and the spare wheel ring painted either obsidian black or Night black magno make for a striking appearance.

Night package (code NP1) – designed and priced as a package, including items listed below.

G 400 d AMG Line Premium/Premium Plus

Total incl. VAT £1,500.00

Consisting of:

- Darkened indicators, tail lights and headlights
- Exterior mirror housing painted obsidian black
- Exterior protective strip with trim insert in black pinstripe
- Spare wheel rim painted obsidian black
- Trim elements bumpers painted in obsidian black



Night package Magno (code NPM) – designed and priced as a package, including items listed below.

G 400 d AMG Line Premium Plus

Total incl. VAT £1,750.00

Consisting of:

- Darkened indicators, tail lights and headlights
- Exterior mirror housing Night black magno
- Exterior protective strip with trim insert in black pinstripe
- Spare wheel rim painted Night black magno
- Trim elements bumpers painted in Night black magno



Only available with magno paints



AMG Night package

Add the AMG Night package to your Mercedes-AMG G 63 to create an even bolder look. Heat-insulating dark-tinted glass in combination with the exterior mirrors and the spare wheel ring painted either obsidian black or Night black magno make for a striking appearance.

AMG Night package (code NP1) – designed and priced as a package, including items listed below.

Mercedes-AMG G 63

Total incl. VAT £2,250.00

Consisting of:

AMG-specific radiator grille, dark chrome-plated

Darkened indicators, tail lights as well as headlights

Exterior mirror housing painted obsidian black

Exterior protective strip with black trim insert in a pinstripe look

Spare wheel cover painted obsidian black

Trim elements in the bumper painted obsidian black



AMG Night package magno (code NPM) – designed and priced as a package, including items listed below.

Mercedes-AMG G 63

Total incl. VAT £2,500.00

Consisting of:

AMG-specific radiator grille, dark chrome-plated

Darkened indicators, tail lights as well as headlights

Exterior mirror housing painted Night black magno

Exterior protective strip with black trim insert in a pinstripe look

Simulated underguard in matt black

Spare wheel cover painted Night black magno

Trim elements in the bumper painted Night black magno



Only available with magno paints. Standard for Mercedes-AMG G 63 Magno Edition

Design	Technology & Safety	Model lines	Model prices	Model line wheels, trim & upholstery	Mercedes-AMG	Mercedes-AMG prices	Mercedes-AMG wheels & upholstery	Personalisation	Standard equipment	Genuine accessories	Technical data	Additional information
--------	---------------------	-------------	--------------	--------------------------------------	--------------	---------------------	----------------------------------	-----------------	--------------------	---------------------	----------------	------------------------

[Book a test drive](#)[Buy your G-Class](#)[Find a Retailer](#)

Standard equipment

● Standard – Not available

Transmission and Suspension

	AMG Line Premium Plus	AMG Line Premium	AMG Line
4MATIC Permanent four-wheel drive with three 100% differentials – complimentary differential oil change required after first 1,800 miles	●	●	●
9G-TRONIC transmission with cruise control and variable speed limiter	●	●	●
AGILITY CONTROL suspension with selective passive damping system	●	–	–
DYNAMIC SELECT with ECO start/stop function and four transmission modes: 'C' (Comfort), 'S' (Sport), 'I' (Individual) and 'M' (Manual)	●	●	●
Suspension with adaptive damping adjustment	–	●	●

Exterior

Adaptive Highbeam Assist Plus – the driver is free to concentrate on the traffic without constantly having to select between low and high beam	●	●	●
Ambient lighting with projection of brand logo	●	●	●
AMG bodystyling with flared wheel arches in vehicle colour	–	●	●
Brake calipers with 'Mercedes-Benz' lettering	–	●	●
Bumpers – painted in body colour, front and rear	●	●	●
Diesel particulate filter	●	●	●
Differential locks (transfer case, front and rear axle)	●	●	●
Door mirrors – electrically adjustable and heated Integrated indicators, front area lighting and automatically dimming driver's mirror	●	●	●
Electric sunroof – sliding, with one-touch opening	–	●	●
Exterior protective strip with trim insert in brushed aluminium	–	●	●
Heated windscreen	–	●	●
Low range gear reduction (electronically selectable while driving)	●	●	●

	AMG Line Premium Plus	AMG Line Premium	AMG Line
MULTIBEAM LED headlamps enable continuous main beam without dazzling other road users. Individually controlled LEDs precisely mask out other vehicles and at the same time illuminate the surroundings in light which is almost as bright as daylight.	●	●	●
Parking package with 360° camera	●	●	●
Privacy glass – dark grey-tinted glass for tailgate and rear side windows	●	●	●
Rain-sensing wipers	●	●	●
Rear mud flaps	●	–	–
Running boards	●	●	●
Spare wheel ring painted in obsidian black	●	●	●
Stainless-steel spare wheel cover	●	●	●
Tail lights featuring LED technology	●	●	●
Trailer coupling with ESP® trailer stabilisation	●	●	●
Underguard - reinforced underfloor panelling the full length of the vehicle	●	●	●

Interior

12V sockets in centre console, rear and load compartment	●	●	●
Ambient lighting – 8 colours	●	●	–
Ambient lighting – 64 colours	–	–	●
AMG floor mats with 'AMG' lettering	–	●	●
AMG steering wheel buttons	–	–	●
Automatically dimming rear-view mirror	●	●	●
Centre armrest between front seats with integrated stowage compartment	●	●	●
Cup holders – front (2) and rear (2)	●	●	●

[Book a test drive](#)[Buy your G-Class](#)[Find a Retailer](#)

Standard equipment

● Standard – Not available

Interior (continued)

	AMG Line Premium Plus	AMG Line Premium	AMG Line
Dashboard – ARTICO man-made leather	●	–	–
Dashboard – leather-covered	–	●	–
Dashboard – Nappa Leather	–	–	●
Electric windows (4)	●	●	●
Front seats – heated and electrically adjustable. Memory function for seats, head restraints, exterior mirrors and steering wheel	●	●	●
Ionisation of interior air including fine-particle activated charcoal filter system	–	–	●
KEYLESS-GO starting function	●	●	●
Luggage compartment cover	●	●	●
Luggage protection net	●	●	●
Rear bench seat – split folding 1/3:2/3	●	●	●
Rear seats – heated	●	●	●
Seat belts, 3-point design in black	●	●	●
Seat belt pre-tensioners (4)	●	●	●
Stainless steel door sill panels, set of four, illuminated, with 'Mercedes-Benz' lettering at the front	●	●	●
Stowage Space package – including removable double cup holder in centre console, bottle holders in door pockets, map pockets on back of front seats, and glasses compartment in overhead control panel	●	●	●
THERMOTRONIC automatic climate control with three climate zones and three climate styles:	●	●	●
Medium, Diffuse and Focused			
Velour floor mats	●	–	–
Ventilated multicontour front seats	–	–	●
Widescreen cockpit with dual bonded 12.3" widescreen displays	●	●	●

Steering

	AMG Line Premium Plus	AMG Line Premium	AMG Line
Multifunction sports steering wheel in nappa leather 3-spoke design, with flattened bottom section, steering wheel trim and shift paddles in silver chrome and Touch Control buttons	–	●	●
Multifunction steering wheel in nappa leather	●	–	–
Steering column – electrically adjustable, with automatic adjustment for entry/exit	●	●	●

Paint, Trim and Upholstery

	AMG Line Premium Plus	AMG Line Premium	AMG Line
Paint – metallic	●	●	●
Roof lining – black	●	●	–
Roof lining – designo black DINAMICA microfibre	–	–	●
Trim – open pore walnut wood	●	–	–
Trim – G manufaktur black flamed open-pore ash wood	–	●	●
Upholstery – leather, black	●	–	–
Upholstery – AMG Line leather, black	–	●	–
Upholstery – AMG Line nappa leather, black	–	–	●

Communications and In-Car Entertainment

	AMG Line Premium Plus	AMG Line Premium	AMG Line
Bluetooth® interface for hands-free telephony	●	●	●
COMAND Online – online-capable multimedia system with display (12.3 inches), touchpad with controller, Touch Control buttons on the steering wheel and LINGUATRONIC voice control system, hard-disk navigation with satellite map display, smartphone integration, communications module for Mercedes me services, 3 years of free online map updates, Live Traffic Information, Mercedes me connect Standard Services, Mercedes-Benz apps, Mercedes-Benz emergency call system, Car-to-X-Communication	●	●	●



Standard equipment

● Standard – Not available

Communications and In-Car Entertainment (continued)

Communications module (LTE) for the use of Mercedes me connect services – preparation for use of Mercedes me connect services with particularly rapid and dependable data transfer

DAB digital radio tuner

Smartphone integration¹ comprising Apple CarPlay® and Android Auto™ – see www.apple.com/uk/ios/carplay/ or www.android.com/intl/en_uk/auto for compatibility and approved apps. Certain features and apps require a 3G/4G data connection. Control of features available through voice control and controller on centre console

Surround sound system – Burmester® surround sound system

16 high-performance speakers as well as electronics and acoustic features tailored specifically to the interior make for the first-class Burmester sound

Touchpad with controller

Safety and Assistance Systems

Active Brake Assist – consisting of proximity and collision warning, situation-dependent braking assistance and also autonomous braking function for vehicles in front, crossing pedestrians and cyclists

Active Lane Keeping Assist

ADAPTIVE BRAKE with HOLD function, Hill-Start Assist, priming and dry braking in the wet

Airbags – driver and front passenger

Airbags – front side

Airbags – sidebags in rear

Airbags – windowbags

AMG Line Premium Plus
AMG Line Premium
AMG Line

AMG Line Premium Plus	AMG Line Premium	AMG Line
●	●	●
●	●	●
●	●	●
–	●	●
●	●	●

AMG Line Premium Plus
AMG Line Premium
AMG Line

AMG Line Premium Plus	AMG Line Premium	AMG Line
●	●	●
●	●	●
●	●	●
●	●	●
●	●	●
●	●	●
●	●	●
●	●	●
●	●	●
●	●	●
●	●	●
●	●	●
●	●	●
●	●	●
●	●	●
●	●	●

Anti-lock braking system (ABS) with Brake Assist (BAS)

Anti-theft alarm system with tow-away protection and interior motion sensor (Thatcham Category 1 compliant)

ATTENTION ASSIST – can detect typical symptoms of drowsiness on the basis of driver behaviour and alert the driver to increasing fatigue and inattention

Driving Assistance package

Electronic Stability Programme (ESP®) with Acceleration Skid Control (ASR)

Four-wheel Electronic Traction System (4ETS)

Headlight Assist – automatic headlamp activation

i-Size child seat attachment system for outer rear seats

PRE-SAFE® system For preventive occupant protection

Service indicator ASSYST

Traffic Sign Assist

Tyre pressure monitoring system

¹Compatible mobile phone required

Design	Technology & Safety	Model lines	Model prices	Model line wheels, trim & upholstery	Mercedes-AMG	Mercedes-AMG prices	Mercedes-AMG wheels & upholstery	Personalisation	Standard equipment	Genuine accessories	Technical data	Additional information
--------	---------------------	-------------	--------------	--------------------------------------	--------------	---------------------	----------------------------------	-----------------	--------------------	---------------------	----------------	------------------------

[Book a test drive](#)[Buy your G-Class](#)[Find a Retailer](#)

Standard equipment Mercedes-AMG

● Standard – Not available

Transmission and Suspension

	G 63	G 63 Magno Edition
4MATIC Permanent four-wheel drive with three 100% differentials – complimentary differential oil change required after first 1,800 miles	●	●
AMG DYNAMIC SELECT with ECO start/stop function and 5 transmission modes 'C' (Comfort), 'S' (Sport), S+ (Sport Plus) and 'M' (Manual)	●	●
AMG high-performance braking system with internally ventilated and perforated brake discs measuring 400×38 mm at the front, 370×22 mm at the rear	●	●
AMG RIDE CONTROL suspension with three settings 'C' (Comfort), 'S' (Sport), S+ (Sport Plus) accessible via DYNAMIC SELECT	●	●
AMG SPEEDSHIFT 9G-TRONIC sports transmission with cruise control and variable speed limiter	●	●

Exterior

Adaptive Highbeam Assist Plus – the driver is free to concentrate on the traffic without constantly having to select between low and high beam	●	●
Ambient lighting with projection of brand logo	●	●
AMG bodystyling with Mercedes-AMG G 63 front aprons with cooling air intakes and flared wheel arches in vehicle colour and bumpers painted in body colour, front and rear	●	–
AMG bodystyling with exclusive AMG flared wheel arches and bumpers in night black magno	–	●
AMG brake calipers, painted red	●	●
AMG Night package Magno	–	●
AMG Night package II – typography in high gloss black and Mercedes-Benz star in high gloss black front and rear	–	●
AMG performance exhaust system, selectable and two chrome-trimmed twin tailpipes, left and right	●	●
AMG-specific radiator grille with AMG logo	●	●
Differential locks (transfer case, front and rear axle)	●	●

	G 63	G 63 Magno Edition
Door mirrors – electrically adjustable and heated Integrated indicators, front area lighting and automatically dimming driver's mirror	●	●
Electric sunroof – sliding, with one-touch opening	●	●
Exterior mirror housings in black	–	●
Exterior protective strip with trim insert in black	●	●
Heated windscreen	●	●
Low range gear reduction (electronically selectable while driving)	●	●
MULTIBEAM LED headlamps enable continuous main beam without dazzling other road users. Individually controlled LEDs precisely mask out other vehicles and at the same time illuminate the surroundings in light which is almost as bright as daylight	●	●
Parking-assistance PARKTRONIC	●	●
Parking package with 360° camera	●	●
Petrol particulate filter	●	●
Privacy glass – dark grey-tinted glass for tailgate and rear side windows	●	●
Rain-sensing wipers	●	●
Running boards	●	●
Spare wheel ring painted in night black magno	–	●
Stainless-steel spare wheel cover	●	–
Tail lights featuring LED technology	●	●
Trailer coupling with ESP® trailer stabilisation	●	●

[Book a test drive](#)[Buy your G-Class](#)[Find a Retailer](#)

Standard equipment Mercedes-AMG

● Standard – Not available

Interior

	G 63	G 63 Magno Edition
12V sockets in centre console, rear and load compartment	●	●
Ambient lighting – 64 colours	●	●
AMG door sill panels in brushed stainless steel, illuminated	●	●
AMG floor mats with 'AMG' lettering	●	●
AMG instrument cluster with dual bonded 12.3" widescreen displays	●	●
AMG-specific IWC-design analogue clock	●	●
AMG steering wheel buttons	●	●
Automatically dimming rear-view mirror	●	●
Centre armrest between front seats with integrated stowage compartment	●	●
Cup holders – front (2) and rear (2)	●	●
Dashboard – Nappa Leather	●	●
Electric windows (4)	●	●
ENERGIZING comfort control	●	●
Front seats – heated and electrically adjustable. Memory function for seats, head restraints, exterior mirrors and steering wheel	●	●
Ionisation of interior air including fine-particle activated charcoal filter system	●	●
KEYLESS-GO starting function	●	●
Luggage compartment cover	●	●
Luggage protection net	●	●
Rear bench seat – split folding 1/3:2/3	●	●
Rear seats – heated	●	●
Seat belts, 3-point design in black	●	●
Seat belt pre-tensioners (4)	●	●

	G 63	G 63 Magno Edition
Stowage Space package – including removable double cup holder in centre console, bottle holders in door pockets, map pockets on back of front seats, and glasses compartment in overhead control panel	●	●
THERMOTRONIC automatic climate control with three climate zones and three climate styles: Medium, Diffuse and Focused	●	●
Ventilated multicontour front seats	●	●

Steering

	G 63	G 63 Magno Edition
AMG performance steering wheel in carbon fibre/DINAMICA microfibre 3-spoke design, with flattened bottom section, steering wheel trim in silver chrome with 'AMG' lettering and silver-coloured aluminium shift paddles, 12 o'clock marking and Touch Control buttons	–	●
AMG performance steering wheel in nappa leather 3-spoke design, with flattened bottom section, steering wheel trim in silver chrome with 'AMG' lettering and silver-coloured aluminium shift paddles, 12 o'clock marking and touch control buttons	●	–
Steering column – electrically adjustable, with automatic adjustment for entry/exit	●	●

Paint, Trim and Upholstery

	G 63	G 63 Magno Edition
Paint – magno	–	●
Paint – metallic	●	–
Roof lining – designo black DINAMICA microfibre	●	●
Trim – AMG carbon fibre	–	●
Trim – G manufaktur black piano lacquer	●	–
Upholstery – AMG G Manufaktur Exclusive nappa leather, black	–	●
Upholstery – AMG G Manufaktur nappa leather, black	●	–

[Book a test drive](#)[Buy your G-Class](#)[Find a Retailer](#)

Standard equipment Mercedes-AMG

● Standard – Not available

Communications and In-Car Entertainment

	G 63	G 63 Magno Edition
Bluetooth® interface for hands-free telephony	●	●
COMAND Online – online-capable multimedia system with display (12.3 inches), touchpad with controller, Touch Control buttons on the steering wheel and LINGUATRONIC voice control system, hard-disk navigation with satellite map display, smartphone integration, communications module for Mercedes me services, 3 years of free online map updates, Live Traffic Information, Mercedes me connect Standard Services, Mercedes-Benz apps, Mercedes-Benz emergency call system, Car-to-X-Communication	●	●
Communications module (LTE) for the use of Mercedes me connect services – preparation for use of Mercedes me connect services with particularly rapid and dependable data transfer	●	●
DAB digital radio tuner	●	●
Smartphone integration ¹ comprising Apple CarPlay® and Android Auto™ – see www.apple.com/uk/ios/carplay/ or www.android.com/intl/en_uk/auto for compatibility and approved apps. Certain features and apps require a 3G/4G data connection. Control of features available through voice control and controller on centre console	●	●
Surround sound system – Burmester® surround sound system 16 high-performance speakers as well as electronics and acoustic features tailored specifically to the interior make for the first-class Burmester sound	●	●
Touchpad with controller	●	●

Safety and Assistance Systems

	G 63	G 63 Magno Edition
Active Brake Assist – consisting of proximity and collision warning, situation-dependent braking assistance and also autonomous braking function for vehicles in front, crossing pedestrians and cyclists	●	●
Active Lane Keeping Assist	●	●
ADAPTIVE BRAKE with HOLD function, Hill-Start Assist, priming and dry braking in the wet	●	●
Airbags – driver and front passenger	●	●
Airbags – front side	●	●
Airbags – sidebags in rear	●	●
Airbags – windowbags	●	●
Anti-lock braking system (ABS) with Brake Assist (BAS)	●	●
Anti-theft alarm system with tow-away protection and interior motion sensor (Thatcham Category 1 compliant)	●	●
ATTENTION ASSIST – can detect typical symptoms of drowsiness on the basis of driver behaviour and alert the driver to increasing fatigue and inattention	●	●
Driving Assistance package	●	●
Electronic Stability Programme (ESP®) with Acceleration Skid Control (ASR)	●	●
Four-wheel Electronic Traction System (4ETS)	●	●
Headlight Assist – automatic headlamp activation	●	●
i-Size child seat attachment system for outer rear seats	●	●
PRE-SAFE® system For preventive occupant protection	●	●
Service indicator ASSYST	●	●
Traffic Sign Assist	●	●
Tyre pressure monitoring system	●	●

¹Compatible mobile phone required

Genuine accessories

We've developed a range of Accessories you can add to help personalise and enhance your G-Class.



Mercedes-Benz roof box 450

Impact-resistant, sturdy, durable, recyclable, spray-protected. Opens on both sides. Single lock system with three locking mechanisms on each side. Gas-filled struts for easy opening and closing of lid. Straps to hold contents in place. Maximum load capacity of 75 kg. (A0008401200)



Bicycle rack

Easy to use, convenient and lightweight. Bicycles can be attached at ground level before the rack is fitted. Up to three bicycle carriers can be fitted at one time. The alustyle cycle carrier is designed for the alustyle basic carrier bars, making your life easier, with know-how from Mercedes-Benz. (A0008900293)

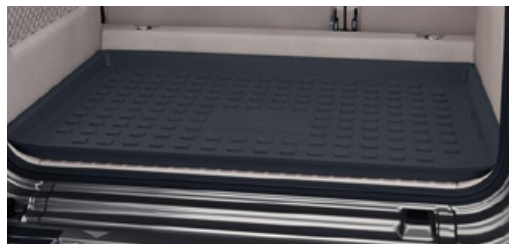

Boot tub, shallow

For your everyday requirements the easy-clean boot tub suits all of your needs. The shape of the tub, with its slightly raised edge, is tailored to the boot with the honeycomb structure preventing slipping. (A4638140000)



Concertina load sill protector

The concertina load sill protector not only protects the boot, but also protects the bumper and boot sill from becoming scratched. As the mat can be folded out, even your clothes stay clean when loading. The load sill guard can be attached via hooks to the lifting eyes or can be attached via a velcro strip to the reversible mat or roof box. (A2536932000)



Basic carrier bars, three crossbars

Aluminium carrier bars, precision-tailored to the body of your Mercedes-Benz – the perfect basis for a range of Mercedes-Benz transport accessories: ski and snowboard rack, bicycle rack or roof boxes. Fitted in next to no time without the use of tools, thanks to new, innovative quick-release fasteners. (A4638902900)



AMG indoor car cover

Silver-coloured, with black AMG lettering. The breathable outer layer in tearproof synthetic fibre and the antistatic inner layer in flannel protect the vehicle against dust and scratches. Elasticated edging at the front and rear ensures that the cover stays in place and provides an ideal fit, particularly for AMG models. (A4638990500)

All the above accessories are subject to availability and compatibility. Please ask your Mercedes-Benz Retailer for more information

Design	Technology & Safety	Model lines	Model prices	Model line wheels, trim & upholstery	Mercedes-AMG	Mercedes-AMG prices	Mercedes-AMG wheels & upholstery	Personalisation	Standard equipment	Genuine accessories	Technical data	Additional information
--------	---------------------	-------------	--------------	--------------------------------------	--------------	---------------------	----------------------------------	-----------------	--------------------	---------------------	----------------	------------------------

[Book a test drive](#)[Buy your G-Class](#)[Find a Retailer](#)

Technical data

● Standard – Not available

Model	G 400 d		Mercedes-AMG G 63	
Engine				
Fuel delivery	Diesel		Petrol	
Total displacement	cc	2,925	3,892	
Arrangement/cylinders/valves	in-line/6/24		V/8/32	
Power ¹	hp (kW) at rpm	326 (243)/3,600–4,200	577 (430)/6,000	
Torque ¹	Nm at rpm	700/1,200–3,200	850/2,500–3,500	
Compression ratio	15.5:1		8.6:1	
Emissions standard	EURO 6D-ISC-FCM		EURO 6D-ISC-FCM	
Transmission				
9G-TRONIC automatic	●		–	
AMG SPEEDSHIFT PLUS 9G-TRONIC	–		●	
Performance				
Acceleration 0–62 mph	sec	6.4	4.5	
Top speed (electric mode) ²	mph	130	137	
Weights and capacities				
Kerb weight ³	kg	2,489	2,560	
Perm. Gross Vehicle Weight	kg	3,150	3,200	
Boot capacity – seats up		667	667	
seats down	l	1,941	1,941	
Towing capacity – unbraked		750	750	
braked	kg	3,500	3,500	

¹Figures according to Directive 80/1269/EEC in the currently applicable version ²Electronically limited ³Mass of the vehicle in running order with at least 90% full fuel tank, plus the mass of the driver (estimated by law at 75 kg), fuel and fluids, equipped with the standard equipment as specified by the manufacturer as well as, where applicable, the mass of the body, cab, trailer coupling and spare wheel(s) as well as tools. Optional extras, additional equipment and accessories can influence the weight, residual payload, rolling resistance, aerodynamics, etc., and therefore also affect the consumption/CO₂ values

[Book a test drive](#)[Buy your G-Class](#)[Find a Retailer](#)

Technical data

Model		G 400 d		Mercedes-AMG G 63
Weights and capacities (cont.)				
Fuel tank capacity/of which reserve	l	100/12		100/12
Turning circle	m	13.60		13.51

Fuel consumption^{4,5,6}				
Combined (consumption dependent on chosen optional equipment)	l/100 km	11.0		16.4
	mpg	25.7		17.2

Insurance				
Group rating		50E		50E

Insurance ratings may vary depending on model line and specification. Please refer to <http://www.thatcham.org/abigrouprating/> for further details

⁴All figures are based on a standard specification with the smallest tyre size available in the UK

⁵The choice of wheels and transmission may affect CO₂ emissions and corresponding Road Fund Licence

⁶The indicated values were determined according to the prescribed measurement method - Worldwide Harmonised Light Vehicle Test Procedure (WLTP). Figures shown may include options which are not available in the UK



Book a test drive



Buy your G-Class



Find a Retailer

Edition/Premium/Premium Plus

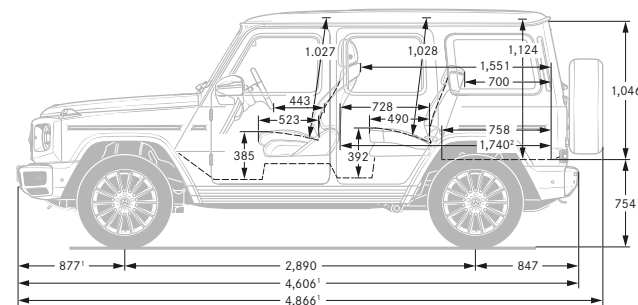
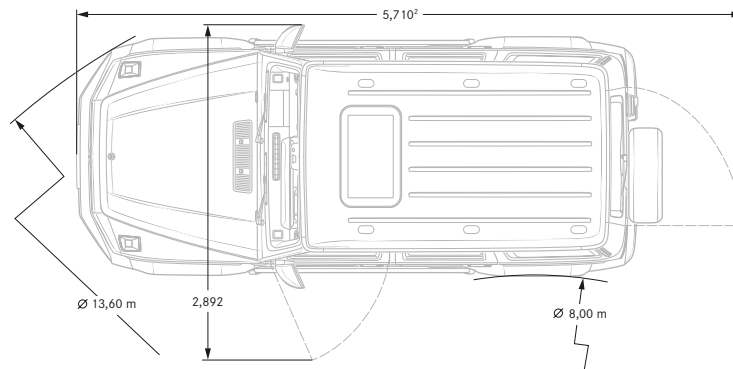
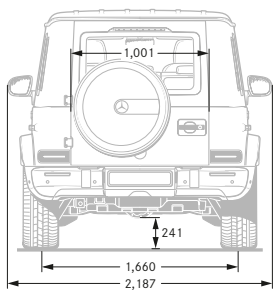
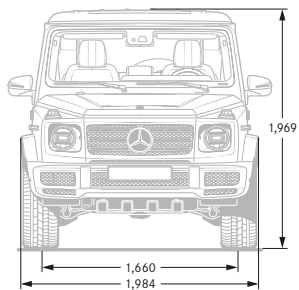

Mercedes-AMG G 63

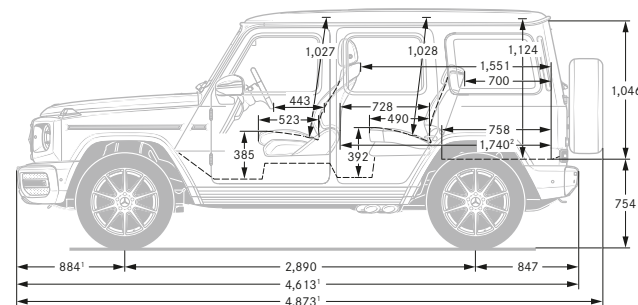
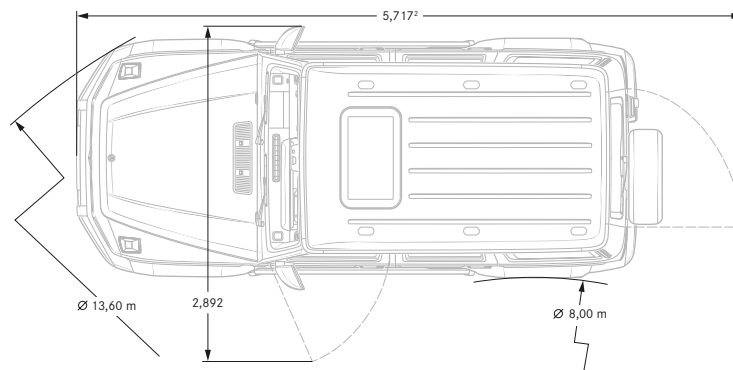
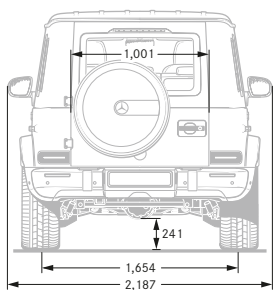
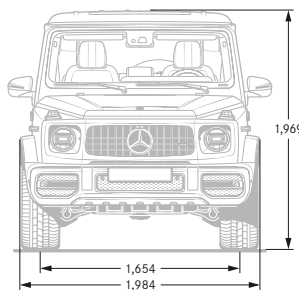

Design	Technology & Safety	Model lines	Model prices	Model line wheels, trim & upholstery	Mercedes-AMG	Mercedes-AMG prices	Mercedes-AMG wheels & upholstery	Personalisation	Standard equipment	Genuine accessories	Technical data	Additional information
--------	---------------------	-------------	--------------	--------------------------------------	--------------	---------------------	----------------------------------	-----------------	--------------------	---------------------	----------------	------------------------



Book a test drive



Buy your G-Class



Find a Retailer

Edition/Premium/Premium Plus – Boot capacity

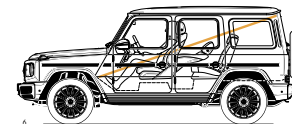
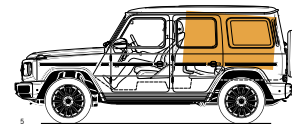
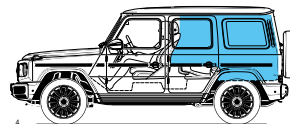
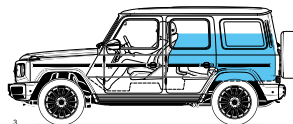
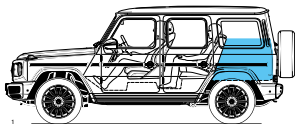

Open luggage compartment behind rear seat, loaded to upper edge of rear seat backrest, volume 621 litres, with backrest in cargo position: volume 667 litres

Open luggage compartment behind rear seat, loaded to roof, volume 1,031 litres, with backrest in cargo position: volume 1,080 litres

Open luggage compartment behind driver's seat, rear seat backrest folded, loaded to upper edge of driver's backrest, volume 1,246 litres

Open luggage compartment behind driver's seat, rear seat backrest folded, loaded to roof, volume 1,941 litres

Largest cuboid: Dimensions 1,420 × 960 × 50 mm, volume 1,150 litres

Longest board: Dimensions 2,700 × 400 × 30 mm

Mercedes-AMG G 63 – Boot capacity

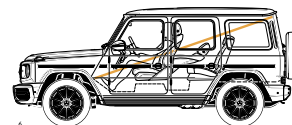
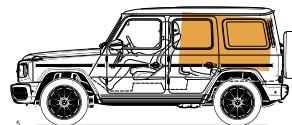
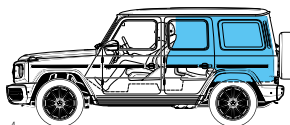
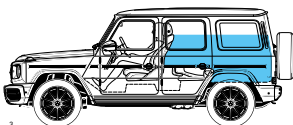
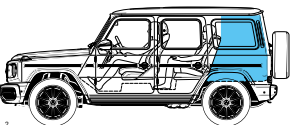
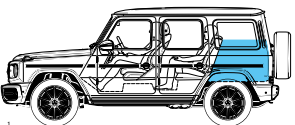

Open luggage compartment behind rear seat, loaded to upper edge of rear seat backrest, volume 621 litres, with backrest in cargo position: volume 667 litres

Open luggage compartment behind rear seat, loaded to roof, volume 1,031 litres, with backrest in cargo position: volume 1,080 litres

Open luggage compartment behind driver's seat, rear seat backrest folded, loaded to upper edge of driver's backrest, volume 1,246 litres

Open luggage compartment behind driver's seat, rear seat backrest folded, loaded to roof, volume 1,941 litres

Largest cuboid: Dimensions 1,420 × 960 × 850 mm, volume 1,150 litres

Longest board: Dimensions 2,700 × 400 × 30 mm

Design	Technology & Safety	Model lines	Model prices	Model line wheels, trim & upholstery	Mercedes-AMG	Mercedes-AMG prices	Mercedes-AMG wheels & upholstery	Personalisation	Standard equipment	Genuine accessories	Technical data	Additional information
--------	---------------------	-------------	--------------	--------------------------------------	--------------	---------------------	----------------------------------	-----------------	--------------------	---------------------	----------------	------------------------



Road Fund Licence

All road vehicle registrations are subject to Vehicle Excise Duty (Road Fund Licence), which varies in accordance with the vehicle's CO₂ emissions. A first year rate for each taxation band will apply. The table below shows the bands (A-M) created by the DVLA and the corresponding Road Fund Licence. CO₂ emissions and the relevant Excise Duty are shown on the model pricing pages.

Band	CO ₂ emissions (g/km)	First year rate petrol and RDE2 diesel (£)	First year rate all other diesel (£) ¹	First year rate alternative fuel (£)	Electric vehicles		Alternative fuel vehicles		Petrol/diesel vehicles	
					Standard rate (£)	Premium rate (£) ²	Standard rate (£)	Premium rate (£) ²	Standard rate (£)	Premium rate (£) ²
A	0	0.00	0.00	0.00	0.00	0.00	0.00	0.00	0.00	0.00
B	1 to 50	10.00	25.00	0.00	0.00	0.00	145.00	480.00	155.00	490.00
C	51 to 75	25.00	115.00	15.00	0.00	0.00	145.00	480.00	155.00	490.00
D	76 to 90	115.00	140.00	105.00	0.00	0.00	145.00	480.00	155.00	490.00
E	91 to 100	140.00	160.00	130.00	0.00	0.00	145.00	480.00	155.00	490.00
F	101 to 110	160.00	180.00	150.00	0.00	0.00	145.00	480.00	155.00	490.00
G	111 to 130	180.00	220.00	170.00	0.00	0.00	145.00	480.00	155.00	490.00
H	131 to 150	220.00	555.00	210.00	0.00	0.00	145.00	480.00	155.00	490.00
I	151 to 170	555.00	895.00	545.00	0.00	0.00	145.00	480.00	155.00	490.00
J	171 to 190	895.00	1,345.00	885.00	0.00	0.00	145.00	480.00	155.00	490.00
K	191 to 225	1,345.00	1,910.00	1,335.00	0.00	0.00	145.00	480.00	155.00	490.00
L	226 to 255	1,910.00	2,245.00	1,900.00	0.00	0.00	145.00	480.00	155.00	490.00
M	over 255	2,245.00	2,245.00	2,235.00	0.00	0.00	145.00	480.00	155.00	490.00



Some of the model features, optional extras and colours shown may not be available, or may only be available in a different specification

¹Applies to all Mercedes-Benz diesel models which do not comply with RDE (Real Driving Emissions) Step 2 Certified (Euro 6d)

²Premium rate only applicable to vehicles where the list price is over £40,000 including any factory-fitted options, standard UK delivery charge, number plates, fuel and VAT



Services and insurance

Mercedes-Benz ServiceCare

We believe that servicing costs should be as flexible and affordable as possible for your G-Class, which is why we offer ServiceCare, an easy way to budget for all your servicing costs. It spreads your bills into manageable payments based on whether you have a new or used Mercedes-Benz. With ServiceCare we guarantee the price of parts and labour for up to four services and safeguard against any further inflation. It also covers the cost of all recommended service items including brake fluid, spark plugs, air filters, fuel filters and screen wash. You can choose either to add your servicing costs into your monthly spend or pay the full amount in a one-off payment, giving you peace of mind that they are taken care of for the period of the plan.

[› Click here for more information](#)

Warranty and breakdown cover

Every Mercedes-Benz comes with a three-year unlimited mileage warranty against manufacturing or material defects¹ and up to 30 years warranty against perforation due to corrosion from the inside out.² What's more, it's also covered by Mercedes-Benz Roadside Assistance – a unique package comprising up to 30 years pan-European breakdown assistance.²

Motor Insurance

We know that once you have chosen your Mercedes-Benz you can't wait to drive it – that's why we created First Cover³. It gives you 7 days' free comprehensive Motor Insurance when you buy a new or used vehicle from a Mercedes-Benz Retailer. We will also send you a quote for annual cover, so you can enjoy the same peace of mind all year round.

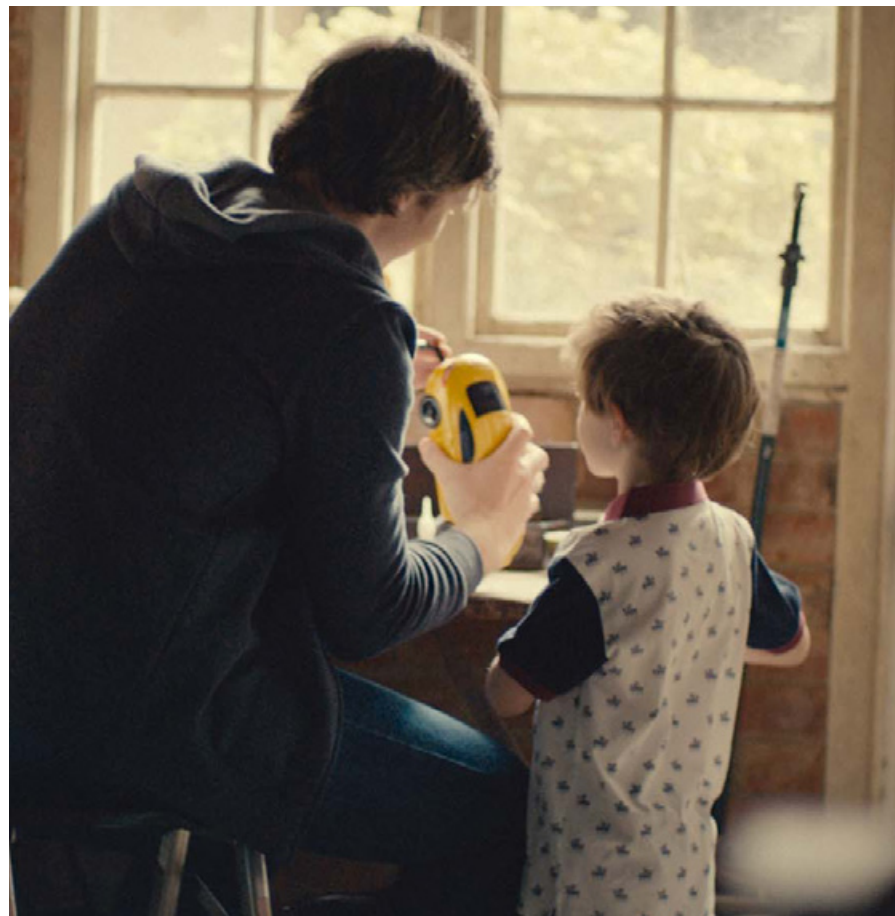
[› Apply for First Cover](#)

¹Applies to vehicles sold by Mercedes-Benz in the UK to its franchised Retailers ²Subject to full Terms and Conditions, dependent on date of registration, available upon request
³Terms and Conditions apply. We are an independent intermediary dealing with selected insurers in respect of annual insurance

Design	Technology & Safety	Model lines	Model prices	Model line wheels, trim & upholstery	Mercedes-AMG	Mercedes-AMG prices	Mercedes-AMG wheels & upholstery	Personalisation	Standard equipment	Genuine accessories	Technical data	Additional information
--------	---------------------	-------------	--------------	--------------------------------------	--------------	---------------------	----------------------------------	-----------------	--------------------	---------------------	----------------	------------------------



Effective from September 2021 Production. Information correct at time of publication 26.07.2021.
Prices and specifications are subject to change without prior notice.
MBW463PL/0721 MY X20+ZX9

