



The new EQB

Effective from February 2022 Production.

MERCEDES-EQ





Book a test drive



Buy your EQB



Find a Retailer



Design	Sustainability	Technology	Mercedes-EQ	EQB AMG Line	EQB AMG Line Premium	EQB AMG Line Launch Edition	Model prices	Personalisation	Standard equipment	Genuine accessories	Technical data	Additional information
--------	----------------	------------	-------------	--------------	----------------------	-----------------------------	--------------	-----------------	--------------------	---------------------	----------------	------------------------



Book a test drive



Buy your EQB



Find a Retailer



Some of the model features, optional extras and colours shown may not be available, or may only be available in a different specification, or at a different price.

Design	Sustainability	Technology	Mercedes-EQ	EQB AMG Line	EQB AMG Line Premium	EQB AMG Line Launch Edition	Model prices	Personalisation	Standard equipment	Genuine accessories	Technical data	Additional information
------------------------	--------------------------------	----------------------------	-----------------------------	------------------------------	--------------------------------------	---	------------------------------	---------------------------------	------------------------------------	-------------------------------------	--------------------------------	--



Book a test drive



Buy your EQB



Find a Retailer



Some of the model features, optional extras and colours shown may not be available, or may only be available in a different specification, or at a different price.

Design	Sustainability	Technology	Mercedes-EQ	EQB AMG Line	EQB AMG Line Premium	EQB AMG Line Launch Edition	Model prices	Personalisation	Standard equipment	Genuine accessories	Technical data	Additional information
--------	----------------	------------	-------------	--------------	----------------------	-----------------------------	--------------	-----------------	--------------------	---------------------	----------------	------------------------

[Book a test drive](#)[Buy your EQB](#)[Find a Retailer](#)

Some of the model features, optional extras and colours shown may not be available, or may only be available in a different specification, or at a different price.

Design	Sustainability	Technology	Mercedes-EQ	EQB AMG Line	EQB AMG Line Premium	EQB AMG Line Launch Edition	Model prices	Personalisation	Standard equipment	Genuine accessories	Technical data	Additional information
------------------------	--------------------------------	----------------------------	-----------------------------	------------------------------	--------------------------------------	---	------------------------------	---------------------------------	------------------------------------	-------------------------------------	--------------------------------	--



Book a test drive



Buy your EQB



Find a Retailer



EQB

Sustainability

Design

Sustainability

Technology

Mercedes-EQ

EQB AMG Line

EQB AMG Line
Premium

EQB AMG Line
Launch Edition

Model prices

Personalisation

Standard
equipment

Genuine
accessories

Technical data

Additional
information



Book a test drive



Buy your EQB



Find a Retailer

Sustainable production.

All of our Mercedes-Benz cars and vans factories around the world plan to be CO₂ neutral by 2022. The EQB is built at the Mercedes-Benz Kecskemet plant in Hungary.



Rastatt factory shown



Sustainable materials.

To ensure the responsible mining of cobalt, lithium and other battery raw materials, Mercedes-Benz has already made the IRMA Standard for Responsible Mining a contractual component for all future vehicle projects.

Sustainable mobility.

Locally emission-free driving pleasure, virtually silent with full access to inner city zones. All our vehicles come as standard with an external acoustic warning to alert pedestrians or cyclists at speeds under 19 mph.

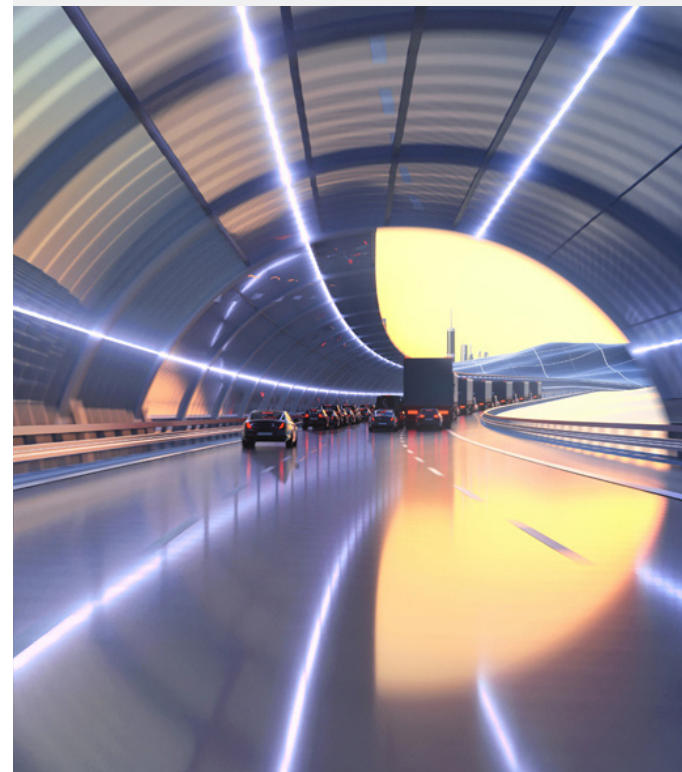

[Book a test drive](#)[Buy your EQB](#)[Find a Retailer](#)

Mercedes me Charge - Green charging



To promote the use of electricity from renewable energies, Mercedes-Benz uses guarantees of origin to 'green' the charging process, whose quality is defined by an eco power label.

This ensures that an equivalent amount of electricity from renewable resources is fed into the grid to compensate for the charging of your EQB.

All new EQBs have three years of Mercedes me Charge as standard and the Green Charging guarantee is included with this.

Design	Sustainability	Technology	Mercedes-EQ	EQB AMG Line	EQB AMG Line Premium	EQB AMG Line Launch Edition	Model prices	Personalisation	Standard equipment	Genuine accessories	Technical data	Additional information
------------------------	--------------------------------	----------------------------	-----------------------------	------------------------------	--------------------------------------	---	------------------------------	---------------------------------	------------------------------------	-------------------------------------	--------------------------------	--



EQB

Technology



Book a test drive



Buy your EQB



Find a Retailer

Mercedes-Benz User Experience (MBUX)

Transforming the in-car user experience, thanks to MBUX: Controlled via voice, touch or optional gesture input, the innovative infotainment system can over time even predict personal habits thanks to artificial intelligence.



Multi-gesture touchpad control



Voice control

- Activated by the keywords “Hey Mercedes”, the new intelligent voice control LINGUATRONIC¹ lets you control many of the infotainment functions, including destination input, phone calls or music selection
- MBUX is able to understand different accents and will adjust to you over time
- MBUX even understands indirect commands. Feeling chilly? Just say “I feel cold” and MBUX will adjust the temperature for you

Touch inputs

- Beside voice control you can operate MBUX via touchscreen, the touchpad on the centre console, as well as touch control buttons on the steering wheel
- The touchpad recognises your handwriting should you wish to enter addresses or phone numbers silently

Personalisation

- Turn the new EQB into your very own Mercedes-Benz by personalising driving modes, radio stations, ambient lighting and much more
- Your personal settings can be saved in up to seven different profiles, making your driving experience the best one possible
- Thanks to artificial intelligence, MBUX is able to learn and adapt over time. It will be able to predict your personal habits, such as navigation for frequently-driven routes, or the radio station you like to listen to on your way home from work

Maintenance and service

- Wondering when the next service is due? Or how much further you can drive until you need to stop at a charging station? Just ask your MBUX – it will tell you the answer

¹LINGUATRONIC off-board functions are currently only available for three years

Design	Sustainability	Technology	Mercedes-EQ	EQB AMG Line	EQB AMG Line Premium	EQB AMG Line Launch Edition	Model prices	Personalisation	Standard equipment	Genuine accessories	Technical data	Additional information
--------	----------------	------------	-------------	--------------	----------------------	-----------------------------	--------------	-----------------	--------------------	---------------------	----------------	------------------------

Mercedes me connect

Stay connected any time, anywhere.

Mercedes me

Mercedes me is a range of innovative online services designed to enhance your Mercedes-Benz experience. Accessible via mobile, tablet or PC, Mercedes me lets you enjoy the highest standards of care and support, in a way that integrates seamlessly with your busy lifestyle.

Safety and Service – Mercedes me connect helps to keep you and your car safe

Check your car's washer fluid level, tyre pressure and battery level from your phone so you'll be ready for every journey.

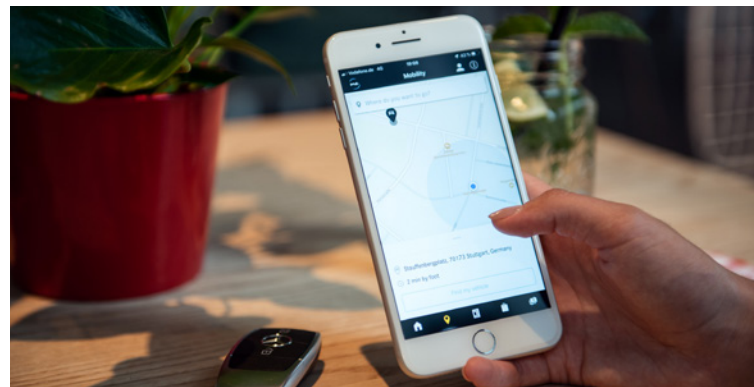

Infotainment – Online and Entertainment services from Mercedes me connect

Love music? Get a 3-month free subscription to Tidal when you connect your car.

Live Traffic Information, Parked Vehicle Locator and much more with Mercedes me connect

Forgot where you've parked? Parked Vehicle Locator¹ will show you exactly where your car is as long as you're in a 1-mile radius of where you parked. Real-time traffic data and dynamic route with shorter journey times.

For more information speak to your local Retailer or visit the Mercedes me connect store at shop.mercedes-benz.com/en-gb/connect

Comfort – connect to your car anytime, anywhere

Forgot to lock your car? With Remote Car Lock² you will receive a notification on your smartphone to let you know. With one tap, you can lock and unlock your vehicle so you never have to worry.

Mercedes-EQ specific services

Check your charging status on the go and programme your pre-entry climate control and charging settings remotely. The Mercedes-EQ specific navigation considers electrical range, topography and charging stations.



¹Available on all models with the Vehicle Monitoring package. This option may vary between standard and additional cost dependent on the model

²Part of the Vehicle Status package. This option may vary between standard and additional cost dependent on the model

Images shown are for illustration purposes only



Book a test drive



Buy your EQB



Find a Retailer

EQB

Mercedes-EQ



Design	Sustainability	Technology	Mercedes-EQ	EQB AMG Line	EQB AMG Line Premium	EQB AMG Line Launch Edition	Model prices	Personalisation	Standard equipment	Genuine accessories	Technical data	Additional information
------------------------	--------------------------------	----------------------------	-----------------------------	------------------------------	--------------------------------------	---	------------------------------	---------------------------------	------------------------------------	-------------------------------------	--------------------------------	--



Book a test drive



Buy your EQB



Find a Retailer

Benefits of driving Mercedes-EQ

Mercedes-EQ couple the locally emission free, refined drive and effortless powertrain of an electric vehicle with the luxury, elegance and high-quality craftsmanship of a Mercedes-Benz.

[Click here for more information](#)

Lower running costs

We've partnered with Go Ultra Low, a joint Government and car industry campaign, to give you unbiased advice on making the switch to an electric car. Use Go Ultra Low's cost saving calculator to see how much you can save. Click [here](#) to discover more.

Performance

Instant torque provides effortless driving pleasure.

No road fund licence

Mercedes-EQ vehicles have no local emissions – this means you pay no road tax.

¹100% first-year capital allowances only apply to vehicles less than 50 g CO₂/km



Cleaner vehicle discount

Mercedes-EQ battery electric vehicles are congestion charge and ultra low emission zone charge exempt in London.

Business benefits

With 100% first-year capital allowances¹ and 2% BIK tax, electric cars offer significant benefits to businesses and employees.

Refinement

Acoustically optimised and a near-silent powertrain means that driving Mercedes-EQ provides a sensory experience of luxurious refinement. All our vehicles come as standard with an external acoustic warning to alert pedestrians or cyclists at speeds under 19 mph.

Design	Sustainability	Technology	Mercedes-EQ	EQB AMG Line	EQB AMG Line Premium	EQB AMG Line Launch Edition	Model prices	Personalisation	Standard equipment	Genuine accessories	Technical data	Additional information
--------	----------------	------------	-------------	--------------	----------------------	-----------------------------	--------------	-----------------	--------------------	---------------------	----------------	------------------------

[Book a test drive](#)[Buy your EQB](#)[Find a Retailer](#)

EQB

MERCEDES-EQ

The compact car family from Mercedes-Benz becomes increasingly electric with the new EQB. Offering locally emission-free, efficient driving combining driving pleasure and performance with dynamic design.

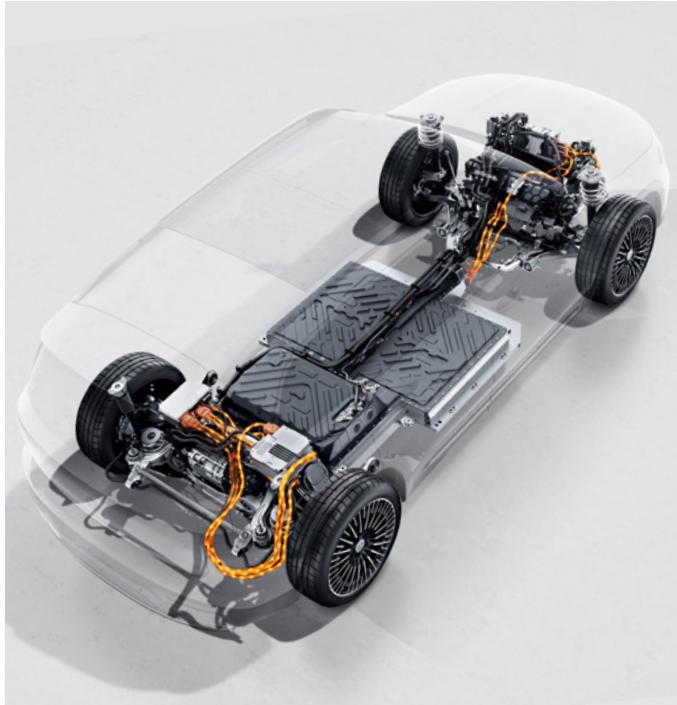

EQB 300 4MATIC

Battery electric vehicle, 228 hp/168 kW
Electric range 250–257 miles – WLTP

EQB 350 4MATIC

Battery electric vehicle, 292 hp/215 kW
Electric range 250–257 miles – WLTP

Standard equipment

Acoustic ambient protection – the tone pitch changes depending on the driving conditions. You can therefore also differentiate whether you are braking or accelerating. Above 19 mph, the system is deactivated since wind and tyre noise tend to dominate at higher speeds

Charging cable – Type 2, Mode 3 cable (5 metres), enables you to charge the vehicle battery via the wallbox or at public charging stations at up to 11kW

Charging socket

Charging system – AC charging system rated at 11kW; DC charging system rated at 100 kW

Pre-entry climate control

Radar-based recuperation

Technical details

Electric range ¹	250–257 miles
Charging time:	
AC outlet (230 V/13 A) 10–100% ^{2,3}	30 hrs
Wallbox (400 V/16 A) 10–100% ²	5 hrs 45 min
Public rapid charging (100 kW) 10–80% ⁴	32 min
Range power consumption, combined ^{3,4}	184–191 Wh/km
Battery type (capacity)	lithium-ion (66.5–66.7 kWh)
Capacity on-board charger	11 kW AC/100 kW DC

Attention



Please be aware that external factors such as weather, gradient and ambient temperature amongst others can significantly impact range.



Please also note that internal factors such as driving style and climate control settings etc. can also significantly impact range.



Using the pre-entry climate control when plugged into a charge point will ensure the perfect ambience and ensure that your car is just how you like it, as well as making sure that your battery isn't used unnecessarily to heat/cool the vehicle (maximising range).

¹Figures shown are for comparability purposes; only compare with other cars tested to the same technical procedures. Figures may not reflect real life driving results, which will depend upon a number of factors including the starting charge of the battery, factory-fitted options, accessories fitted (post registration), variations in weather, driving styles and vehicle load. Further information about the test used to establish range, power consumption and CO₂ figures can be found at <http://www.mercedes-benz.co.uk/WLTP> ²Specified voltage and current values refer to network infrastructure and can be limited by the vehicle. Times are from 10–100% charge using a wallbox (three-phase) or standard socket (single-phase) ³If you are planning to charge your Mercedes-Benz plug-in electric vehicle using a 3-pin domestic plug socket you must get a qualified electrician to inspect and sign off the socket to confirm it is safe and suitable to charge your vehicle. Do not use an electric vehicle 3-pin charge cable with an extension cord) ⁴Specified voltage and current values refer to network infrastructure and can be limited by the vehicle. Times are from 10–80% charge using public rapid charging at 100kW

Mercedes me Charge

One registration, one contract, one billing.

Mercedes *me*

Mercedes me Charge provides access to a multitude of public charging stations located in shopping centers, hotels or at motorway services. A smartphone app as well as the vehicle's navigation system show the precise location, current availability and price at the selected charging station.

Tens of thousands charging stations in the UK

Growing network of charging providers includes bp pulse the largest charging network in the UK. Customers also get six months free bp pulse+ membership which reduces the electricity price when charging.



Access to fast-charging stations

Enables customers to get access to charging stations of different providers with:

- Mercedes me app
- RFID card
- Mercedes-EQ Vehicle Head unit

Green charging

All charging using Mercedes me Charge, will be retrospectively 'greened' by Mercedes-Benz. Please click [here](#) for more info.

Transparent and easy billing

One invoice charging processes for payment.

Easy access

Charging stations are displayed in Mercedes me app and in MBUX multimedia system.

No fees

Mercedes me Charge is standard for three years with discounted IONITY rapid-charging for one year.



Home charging Simple, convenient, fast charging.



Mercedes-Benz plug-in vehicle customers with off-street parking can benefit from the convenience and speed of charging at home by installing a home charger. The 7 kW home chargers deliver a full charge overnight in around 11 hours¹ – that’s up to three times faster than using a 13A three-pin domestic plug.²

Home charger 7 kW: **£875*** incl. VAT & standard installation

Key benefits of the 7 kW home charger:

Robust and weatherproof, for indoor or outdoor use, and comes with a three year warranty. Keep track of your charging using your chosen providers’ app – available on both the App Store and the Google Play Store.

OZEV Grant:

You may be entitled to claim for an OZEV grant towards the cost of your home charger.³ To find out whether you are entitled please contact your chosen charging partner.

Questions? Please contact your local Retailer to submit an enquiry to your chosen charging partner on your behalf. To find your local Retailer, please click the button at the top right hand corner.

Warning! If you are planning to charge your Mercedes-Benz plug-in electric vehicle using a 3-pin domestic plug socket you must get a qualified electrician to inspect and sign off the socket to confirm it is safe and suitable to charge your vehicle. Do not use an electric vehicle 3-pin charge cable with an extension cord.



*Price excludes £350 OZEV EVHS Grant. Price correct at time of publication, subject to change

¹Specified voltage and current values refer to network infrastructure and can be limited by the vehicle. Times are from 10-100% charge using a wallbox (three-phase) or standard socket (single-phase)

²Based on 7kW power output ³The home charger £350 Grant (including VAT) is only available to customers who meet the criteria of the Office for Zero Emission Vehicles (OZEV). For full details and eligibility criteria for the OZEV EVHS Grant, see <https://www.gov.uk/government/publications/electric-vehicle-homecharge-scheme-guidance-for-customers-version-21>.

Design	Sustainability	Technology	Mercedes-EQ	EQB AMG Line	EQB AMG Line Premium	EQB AMG Line Launch Edition	Model prices	Personalisation	Standard equipment	Genuine accessories	Technical data	Additional information
--------	----------------	------------	-------------	--------------	----------------------	-----------------------------	--------------	-----------------	--------------------	---------------------	----------------	------------------------

EQB AMG Line



Option shown: cosmos black metallic (code 191)

High specification as standard.

The EQB AMG Line includes strong specification as standard inside and outside. The interior features two 10-inch displays creating the widescreen cockpit, heated front seats as well as ARTICO man-made leather/DINAMICA microfibre upholstery in black with red topstitching.

On the exterior, AMG bodystyling as well as the iconic radiator grille with twin-blade design ensure for a sporty styling.

EQB AMG Line

OTR from £53,610¹

¹The recommended on-the-road price includes the Road Fund Licence applicable to the standard model plus delivery charge (£780.00 incl.VAT), new vehicle registration fee (£55.00) and number plates (£25.00 incl.VAT). VAT is calculated at the standard rate of 20%. Some of the model features, optional extras and colours shown may not be available, or may only be available in a different specification, or at a different price

Design	Sustainability	Technology	Mercedes-EQ	EQB AMG Line	EQB AMG Line Premium	EQB AMG Line Launch Edition	Model prices	Personalisation	Standard equipment	Genuine accessories	Technical data	Additional information
--------	----------------	------------	-------------	--------------	----------------------	-----------------------------	--------------	-----------------	--------------------	---------------------	----------------	------------------------

EQB AMG Line Standard equipment highlights



Option shown: cosmos black metallic (code 191)

Option shown: cosmos black metallic (code 191)

Exterior

18" AMG alloy wheels – 5-spoke design, aerodynamically optimised, painted high-gloss black with a high-sheen finish (code RQQ)

AMG bodystyling including AMG front apron with integrated air curtain and AMG rear apron with diffusor optics

Badge on the wing in high-gloss black with blue 'EQB' lettering

Black panel radiator grille with twin-blade design in chrome

EASY-PACK tailgate

Front and rear LED light band

Illuminated door sills with 'EQB' lettering

Mirror package – electrically folding mirrors and automatically-dimming exterior driver's mirror and rear-view mirror

Parking package with reversing camera

Polished aluminium roof rails

Privacy glass

Summer tyres

Surround lighting with projection of brand logo





Interior

Ambient lighting – 64-colours

Aluminium with rubber studs

AMG floor mats

Heated front seats

Multifunction sports steering wheel in nappa leather with galvanised shift paddles and flattened bottom section

Seat Comfort package – including manual front passenger seat height adjustment, manual seat cushion angle adjustment for the driver and front passenger and driver manual seat cushion depth adjustment for improved seating comfort thanks to a 60 mm greater supporting surface for the thighs

Sports seats

THERMOTRONIC automatic climate control

Communications, Safety and Assistance Systems

Active Lane Keeping Assist

Active Speed Limit Assist

MBUX multimedia system with widescreen cockpit (two 10-inch displays with touchpad)

Mercedes-Benz sound system with one centre speaker, two Frontbass speakers, two tweeters, four mid-range speakers and 225W amplifier output

Smartphone integration¹ including Apple CarPlay® and Android Auto™

URBAN GUARD vehicle protection

¹Compatible mobile phone required



Trim and Upholstery

Black open-pore linden wood

ARTICO man-made leather/DINAMICA microfibre in black with red topstitching

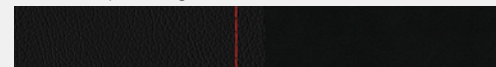

EQB AMG Line Premium



Option shown: MANUFAKTUR patagonia red metallic (code 993)

Take your EQB to the next level.

The AMG Line Premium elevates the EQB through the addition of the electrically operated panoramic glass sunroof and the 19" AMG 5-twin spoke alloy wheels. Besides, the KEYLESS-GO Comfort package, the Advanced Sound System with 10 speakers and wireless charging for mobile devices form part of the standard specification.

EQB AMG Line Premium
Upgrade price from EQB AMG Line

OTR from £56,610¹
£3,000

¹The recommended on-the-road price includes the Road Fund Licence applicable to the standard model plus delivery charge (£780.00 incl.VAT), new vehicle registration fee (£55.00) and number plates (£25.00 incl.VAT). VAT is calculated at the standard rate of 20%. Some of the model features, optional extras and colours shown may not be available, or may only be available in a different specification, or at a different price

Design	Sustainability	Technology	Mercedes-EQ	EQB AMG Line	EQB AMG Line Premium	EQB AMG Line Launch Edition	Model prices	Personalisation	Standard equipment	Genuine accessories	Technical data	Additional information
--------	----------------	------------	-------------	--------------	----------------------	-----------------------------	--------------	-----------------	--------------------	---------------------	----------------	------------------------

EQB AMG Line Premium Standard equipment highlights



Option shown: MANUFAKTUR patagonia red metallic (code 993)

Option shown: MANUFAKTUR patagonia red metallic (code 993)

In addition to/replacement of AMG Line:

Exterior

19" AMG alloy wheels – 5-twin spoke design, aerodynamically optimised, painted high-gloss black with a high-sheen finish (code RTF)

KEYLESS-GO Comfort package

Electrically operated panoramic glass sunroof

Summer tyres



Panoramic glass sunroof



Design	Sustainability	Technology	Mercedes-EQ	EQB AMG Line	EQB AMG Line Premium	EQB AMG Line Launch Edition	Model prices	Personalisation	Standard equipment	Genuine accessories	Technical data	Additional information
------------------------	--------------------------------	----------------------------	-----------------------------	------------------------------	--------------------------------------	---	------------------------------	---------------------------------	------------------------------------	-------------------------------------	--------------------------------	--



Wireless charging¹ for mobile devices

Communications, Safety and Assistance Systems

Advanced Sound System with 10 speakers and a total system output of 225 watts. One central mid-range speaker, one mid-range speaker in each of the front doors, one tweeter each A-Pillar and one subwoofer bass box in the rear including separate booster amplifier

Wireless charging¹ for mobile devices

¹Compatible mobile phone required



Advanced Sound System

Trim and Upholstery

Black open-pore linden wood

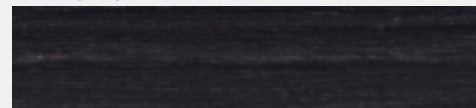

ARTICO man-made leather/DINAMICA microfibre in black with red topstitching

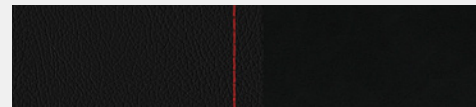

EQB AMG Line Launch Edition



Option shown: mountain grey metallic metallic (code 787)

Top of the range.

The AMG Line Launch Edition includes additional comfort features, such as the Parking package with a 360° camera, the head-up display, MBUX Interior Assistant and the Driving Assistance package. Also part of the standard specification is the adjustable damping suspension with speed-sensitive power steering.

EQB AMG Line Launch Edition
Upgrade price from EQB AMG Line Premium

OTR from £61,210¹
£4,600

¹The recommended on-the-road price includes the Road Fund Licence applicable to the standard model plus delivery charge (£780.00 incl. VAT), new vehicle registration fee (£55.00) and number plates (£25.00 incl. VAT). VAT is calculated at the standard rate of 20%. Some of the model features, optional extras and colours shown may not be available, or may only be available in a different specification, or at a different price

Design	Sustainability	Technology	Mercedes-EQ	EQB AMG Line	EQB AMG Line Premium	EQB AMG Line Launch Edition	Model prices	Personalisation	Standard equipment	Genuine accessories	Technical data	Additional information
--------	----------------	------------	-------------	--------------	----------------------	-----------------------------	--------------	-----------------	--------------------	---------------------	----------------	------------------------

EQB AMG Line Launch Edition Standard equipment highlights



Option shown: mountain grey metallic metallic (code 787)

Option shown: mountain grey metallic metallic (code 787)

In addition to/replacement of AMG Line Premium:

Engine, Transmission and Suspension

Electrically adjustable damping suspension with speed sensitive power steering

Exterior

20" AMG alloy wheels – multi-spoke design, aerodynamically optimised, painted high-gloss black with a high-shine finish (code RVU)

Parking package with 360° camera

Summer tyres

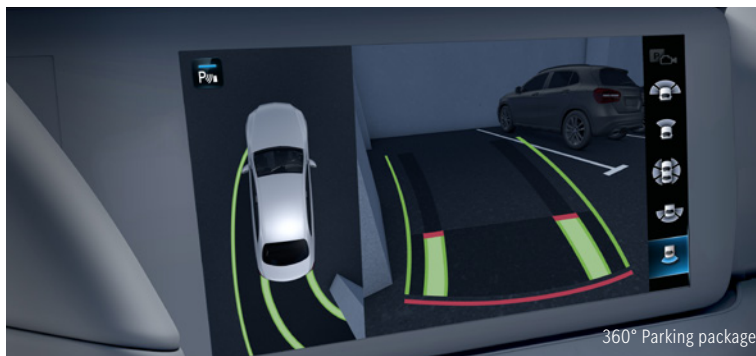

360° Parking package



Design	Sustainability	Technology	Mercedes-EQ	EQB AMG Line	EQB AMG Line Premium	EQB AMG Line Launch Edition	Model prices	Personalisation	Standard equipment	Genuine accessories	Technical data	Additional information
--------	----------------	------------	-------------	--------------	----------------------	-----------------------------	--------------	-----------------	--------------------	---------------------	----------------	------------------------



Interior

Memory Seats package

Communications, Safety and Assistance Systems

Head-up display

Driving Assistance package

MBUX Interior Assistant (gesture control)

Memory Seats package



Trim and Upholstery

Black open-pore linden wood

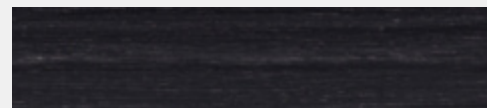

ARTICO man-made leather/DINAMICA microfibre in black with red topstitching

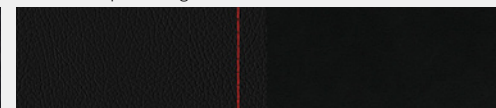

[Book a test drive](#)[Buy your EQB](#)[Find a Retailer](#)

Model prices

Model line	Powertrain	CO ₂ *	Basic RRP excl. VAT (£)	Total RRP incl. VAT (£)	Road Fund Licence (£) ²	Rec. OTR price (£) ³	P11D value (£)	BiK tax rate 2022/23 (%) ²
AMG Line								
EQB 300 4MATIC	Battery electric vehicle, 228 hp/168 kW Electric range 250-257 miles - WLTP ¹	0	43,958.33	52,750.00	0.00	53,610.00	53,555.00	2
EQB 350 4MATIC	Battery electric vehicle, 292 hp/215 kW Electric range 250-257 miles - WLTP ¹	0	45,208.33	54,250.00	0.00	55,110.00	55,055.00	2
AMG Line Premium								
EQB 300 4MATIC	Battery electric vehicle, 228 hp/168 kW Electric range 250-257 miles - WLTP ¹	0	46,458.33	55,750.00	0.00	56,610.00	56,555.00	2
EQB 350 4MATIC	Battery electric vehicle, 292 hp/215 kW Electric range 250-257 miles - WLTP ¹	0	47,708.33	57,250.00	0.00	58,110.00	58,055.00	2
AMG Line Launch Edition								
EQB 300 4MATIC	Battery electric vehicle, 228 hp/168 kW Electric range 250-257 miles - WLTP ¹	0	50,291.67	60,350.00	0.00	61,210.00	61,155.00	2
EQB 350 4MATIC	Battery electric vehicle, 292 hp/215 kW Electric range 250-257 miles - WLTP ¹	0	51,541.67	61,850.00	0.00	62,710.00	62,655.00	2

¹The indicated values were determined according to the prescribed measurement method - Worldwide Harmonised Light Vehicle Test Procedure (WLTP). Figures shown may include options which are not available in the UK. Battery Electric Vehicles (BEV) require mains electricity for charging, range figures determined with the battery fully charged. ²Figures shown are for comparability purposes; only compare with other cars tested to the same technical procedures. Figures may not reflect real life driving results, which will depend upon a number of factors including the starting charge of the battery, factory-fitted options, accessories fitted (post registration), variations in weather, driving styles and vehicle load. Further information about the test used to establish range, power consumption and CO₂ figures can be found at <http://www.mercedes-benz.co.uk/WLTP> ³A different first year rate of Vehicle Excise Duty (Road Fund Licence) applies for new cars. Please refer to page 40 for the relevant rate for the second and subsequent years ⁴The recommended on-the-road price includes the Road Fund Licence applicable to the standard model plus delivery charge (£780.00 incl. VAT), new vehicle registration fee (£55.00) and number plates (£25.00 incl. VAT). VAT is calculated at the standard rate of 20%. Some of the model features, optional extras and colours shown may not be available, or may only be available in a different specification, or at a different price

[Book a test drive](#)[Buy your EQB](#)[Find a Retailer](#)

Colour options Non-metallic and metallic paints

Standard
 No-cost option
 Optional
 Not available

**696 night black non-metallic**

AMG Line	<input checked="" type="checkbox"/>
AMG Line Premium	<input checked="" type="checkbox"/>
AMG Line Launch Edition	<input checked="" type="checkbox"/>
Total RRP incl. VAT	–

**144 digital white metallic**

AMG Line	<input type="checkbox"/>
AMG Line Premium	<input type="checkbox"/>
AMG Line Launch Edition	<input type="checkbox"/>
Total RRP incl. VAT	£895.00

**667 denim blue metallic**

AMG Line	<input type="checkbox"/>
AMG Line Premium	<input type="checkbox"/>
AMG Line Launch Edition	<input type="checkbox"/>
Total RRP incl. VAT	£895.00

**149 polar white non-metallic**

AMG Line	<input type="checkbox"/>
AMG Line Premium	<input type="checkbox"/>
AMG Line Launch Edition	<input type="checkbox"/>
Total RRP incl. VAT	–

**191 cosmos black metallic**

AMG Line	<input type="checkbox"/>
AMG Line Premium	<input type="checkbox"/>
AMG Line Launch Edition	<input type="checkbox"/>
Total RRP incl. VAT	£895.00

**775 iridium silver metallic**

AMG Line	<input type="checkbox"/>
AMG Line Premium	<input type="checkbox"/>
AMG Line Launch Edition	<input type="checkbox"/>
Total RRP incl. VAT	£895.00

Please note that, owing to limitations of on-screen representation, paint colours may differ from those shown

Colour options Metallic and MANUFAKTUR paints

○ Optional – Not available



787 mountain grey metallic

AMG Line	<input type="radio"/>
AMG Line Premium	<input type="radio"/>
AMG Line Launch Edition	<input type="radio"/>
Total RRP incl. VAT	£895.00



993 MANUFAKTUR patagonia red metallic

AMG Line	<input type="radio"/>
AMG Line Premium	<input type="radio"/>
AMG Line Launch Edition	<input type="radio"/>
Total RRP incl. VAT	£1,195.00



817 rosé gold metallic

AMG Line	<input type="radio"/>
AMG Line Premium	<input type="radio"/>
AMG Line Launch Edition	<input type="radio"/>
Total RRP incl. VAT	£895.00

Please note that, owing to limitations of on-screen representation, paint colours may differ from those shown



Book a test drive



Buy your EQB



Find a Retailer

Driving Assistance package

The Driving Assistance package contains a range of highly intelligent features to help you stay safe on the road – by making the drive more effortless, by warning of danger, and by taking steps to protect you in an emergency.

Driving Assistance package (code PAY) – designed and priced as a package

Available on AMG Line and AMG Line Premium only
Total incl. VAT £1,495.00

Standard on AMG Line Launch Edition

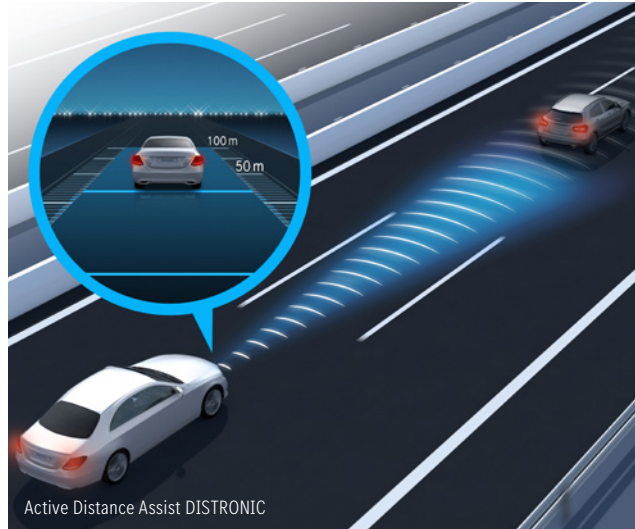

Active Distance Assist DISTRONIC

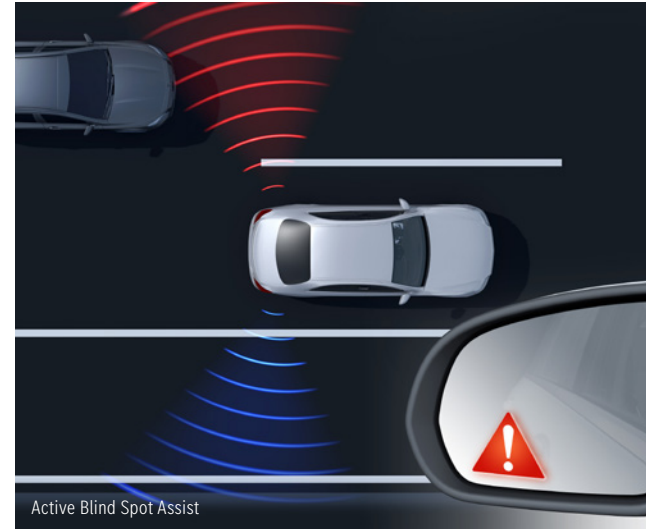

Active Blind Spot Assist

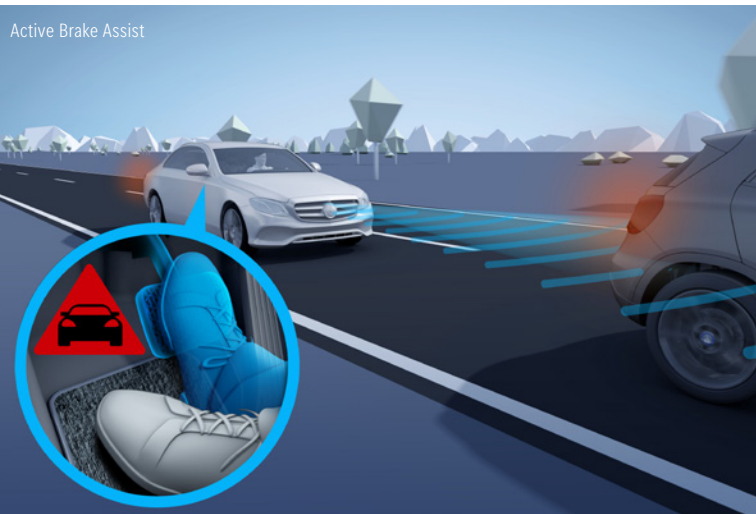

Active Brake Assist

Active Distance Assist DISTRONIC

- Active Speed Limit Assist
- Extended automatic re-start on motorways
- Route-based speed adaptation with end of traffic jam function

Active Blind Spot Assist with Exit warning function can warn the driver of vehicles in the blind spot when driving or when opening the door to exit the vehicle

Active Steering Assist

- Active Emergency Stop Assist with SOS function – immediate emergency braking if evasion is impossible
- Active Steering Assist prevents unintentional drifting out of lane through targeted steering intervention

Active Brake Assist with turning manoeuvre function, cross-traffic function and congestion emergency braking function

Evasive Steering Assist can support the driver in making evasive manoeuvres if, in a dangerous situation, he/she moves to avoid any pedestrian detected by the system

Active Lane Keeping Assist

Pedestrian warning function near pedestrian crossings

Design

Sustainability

Technology

Mercedes-EQ

EQB AMG Line

EQB AMG Line Premium

EQB AMG Line Launch Edition

Model prices

Personalisation

Standard equipment

Genuine accessories

Technical data

Additional information

[Book a test drive](#)[Buy your EQB](#)[Find a Retailer](#)

Standard equipment

● Standard – Not available

Battery and Charging

	AMG Line	AMG Line Premium	AMG Line Launch Edition
11kW AC on-board charger	●	●	●
66.5 kWh battery	●	●	●
100 kW DC on-board charger	●	●	●
CCS-2 connector (DC charging with Combined Charging System, compatible with AC and DC)	●	●	●
Charging cable – Type 2, Mode 3 cable (5 metres), enables you to charge the vehicle battery via the wallbox or at public charging stations at up to 11kW	●	●	●
IONITY – one year, Rapid charging with IONITY	●	●	●
Mercedes me Charge – three year subscription – fully integrated access to a host of public charging stations. A single contract covers all billing. One-time registration and activation as part of Mercedes me connect. Use via app, MBUX multimedia system or RFID card	●	●	●

Steering and Suspension

	AMG Line	AMG Line Premium	AMG Line Launch Edition
Active Steering Assist	–	–	●
Comfort suspension	●	●	–
Cruise control	●	●	●
DYNAMIC SELECT – four different drive programs: MAX RANGE, ECO, COMFORT and SPORT. Five recuperation levels: D Auto (ECO Assist, standard setting); D + (coasting); D (low recuperation); D - (medium recuperation); D - - (high recuperation)	●	●	●
Electrically adjustable damping suspension with speed sensitive power steering	–	–	●

Exterior

	AMG Line	AMG Line Premium	AMG Line Launch Edition
Adaptive Highbeam Assist	●	●	●
AMG Line bodystyling – AMG front apron with integrated air curtain and AMG rear apron with diffuser optics	●	●	●
EASY-PACK tailgate	●	●	●
Electrically operated panoramic glass sunroof	–	●	●
Heat-insulating dark-tinted glass	●	●	●
LED high-performance headlamps	●	●	●
Mirror package – automatically-dimming interior and exterior driver's mirrors; heated electrically-folding exterior mirrors	●	●	●
Parking package with 360° camera	–	–	●
Parking package with reversing camera	●	●	–
Polished aluminium roof rails	●	●	●
Surround lighting with projection of brand logo	●	●	●
Windscreen wipers with rain sensor	●	●	●

Wheels

	AMG Line	AMG Line Premium	AMG Line Launch Edition
18" AMG alloy wheels – 5-spoke design, aerodynamically optimised, painted high-gloss black with a high-sheen finish, with 235/55 R18 tyres (code RQQ)	●	–	–
19" AMG alloy wheels – 5-twin spoke design, aerodynamically optimised, painted high-gloss black with a high-sheen finish, with 235/50 R19 tyres (code RTF)	–	●	–
20" AMG alloy wheels – multi-spoke design, aerodynamically optimised, painted high-gloss black with a high-sheen finish, with 235/45 R20 tyres (code RVU)	–	–	●
Summer tyres	●	●	●

[Book a test drive](#)[Buy your EQB](#)[Find a Retailer](#)

Standard equipment

● Standard – Not available △ Part of an optional package

Interior

	AMG Line	AMG Line Premium	AMG Line Launch Edition
Ambient lighting – 64 colours, Colour changing based on temperature setting. Dynamic mode: atmospheric colour changes thanks to slow, stepless transition between different colours. When plugging in the charging cable, each state of charge is visualised for approx. 30 seconds, similar to the LED in the charging socket: establishing connection (pulsating yellow), ready to charge (continuous yellow), battery is being charged (pulsating green), battery full (continuous green)	●	●	●
Auto-dimming interior mirror	●	●	●
Door sills – illuminated with 'EQB' lettering	●	●	●
Double cupholder	●	●	●
Floor mats – velour floor mats with AMG lettering	●	●	●
Interior Light package	●	●	●
Multifunction sports steering wheel in nappa leather	●	●	●
Pedals – aluminium with rubber studs	●	●	●
Rear armrest with through-load feature	●	●	●
Seats – heated front seats	●	●	●
Seats – Memory Seats package	–	–	●
Seats – Seat Comfort package including manual front passenger seat height adjustment, manual seat cushion angle adjustment for the driver and front passenger and driver manual seat cushion depth adjustment for improved seating comfort thanks to a 60 mm greater supporting surface for the thighs	●	●	●
Seats – sports seats	●	●	●
Shift paddles – galvanised	●	●	●
Stowage compartment with retractable cover	●	●	●

	AMG Line	AMG Line Premium	AMG Line Launch Edition
Stowage package – 12V socket left of the luggage compartment; collapsible crate under load compartment floor; map pockets on backs of the front seats; stowage compartment under load compartment floor (lockable); twin USB charging ports in the rear (type C)	●	●	●

	AMG Line	AMG Line Premium	AMG Line Launch Edition
THERMOTRONIC automatic climate control	●	●	●

	AMG Line	AMG Line Premium	AMG Line Launch Edition
Third seat row with folding single seats with ISOFIX	●	●	●

Paint, Trim and Upholstery

	AMG Line	AMG Line Premium	AMG Line Launch Edition
Paint – non-metallic	●	●	●
Roof lining – black fabric	●	●	●
Trim – black open-pore linden wood	●	●	●
Upholstery – ARTICO man-made leather/DINAMICA microfibre in black with red topstitching	●	●	●

Safety and Assistance Systems

	AMG Line	AMG Line Premium	AMG Line Launch Edition
Active Brake Assist	●	●	●
Active Lane Keeping Assist	●	●	●
Active Speed Limit Assist	●	●	●
Driving Assistance package	△	△	●
KEYLESS-GO Comfort package	–	●	●
Kneebag	●	●	●
Mercedes-Benz emergency call system	●	●	●
Tirefit	●	●	●
URBAN GUARD vehicle protection	●	●	●

[Book a test drive](#)[Buy your EQB](#)[Find a Retailer](#)

Standard equipment

● Standard – Not available

Communications and In-Car Entertainment

	AMG Line	AMG Line Premium	AMG Line Launch Edition
Digital radio	●	●	●
Hard disk navigation	●	●	●
Head-up display	–	–	●
Live Traffic Information (free for first three years)	●	●	●
Mercedes-EQ navigation services – navigation optimised for Mercedes EQ; Display of charging stations (info on availability); Range on map (range display); Programming of charging settings and pre-entry climate control, including remote retrieval of charging status and range	●	●	●
MBUX Interior Assistant (gesture control)	–	–	●
MBUX multimedia system with widescreen cockpit (two 10-inch displays with touchpad)	●	●	●
Smartphone integration ¹	●	●	●
Sound system – Advanced Sound System with 10 speakers and a total system output of 225 watts. One central mid-range speaker, one mid-range speaker in each of the front doors, one tweeter each A-Pillar and one subwoofer bass box in the rear including separate booster amplifier	–	●	●
Sound system – Mercedes-Benz sound system with one centre speaker, two Frontbass speakers, two tweeters, four mid-range speakers and 225W amplifier output	●	–	–
Wireless charging ¹ for mobile devices	–	●	●

Services

Vehicle Set-up and Vehicle Monitoring – three years; remote retrieval of vehicle status; programming of auxiliary heating/ventilation; remote door locking and unlocking; parking damage and theft notification; notification when exceeding the road speed; Send2Car; parked vehicle locator; geofencing; remote vehicle finder

AMG Line	AMG Line Premium	AMG Line Launch Edition
●	●	●

¹Compatible mobile phone required

Genuine accessories

We've developed a range of accessories you can add to help personalise and enhance your EQB.



DUO plus child seat, with ISOFIX

Safe and secure: children between the ages of 9 months and 4 years (weight 9 to 18 kg) will enjoy travelling in the 'DUO plus' child seat from Mercedes-Benz. The seat offers optimum protection in the event of an accident. A quick change of position: sitting, reclining and sleeping positions are adjustable with one simple manoeuvre. (A0009704302)



KIDFIX XP child seat, with ISOFIX

Support and safety for older children too: The KIDFIX XP child seat is suitable for children between the ages of 3.5 to 12 years (body weight of 15–36 kg). It is securely attached to the vehicle using ISOFIX. The front-facing seat can also be secured in place using the 3-point seat belt. (A0009704902)



Reversible mat

This anti-slip mat by Mercedes-Benz protects the boot floor during loading and unloading. Made from 100% polyester. Double-sided: with rubberised, non-slip side and high-quality velour side. Prevents cargo from sliding around. Protects the load compartment floor from dirt and damp. Easy to clean with warm water. (A2476841600)



Basic carrier bars roof rails

Aluminium carrier bars, precision-tailored to the body of your Mercedes-Benz. They provide the perfect basis for a range of Mercedes-Benz transport accessories: ski and snowboard rack, bicycle rack or roof boxes. Aerodynamic Mercedes-Benz design with optimised noise level. Crash-tested and lockable. (A2478903100)

All the above accessories are subject to availability and compatibility. Please ask your Mercedes-Benz Retailer for more information. Images shown are for illustration purposes only.

Design	Sustainability	Technology	Mercedes-EQ	EQB AMG Line	EQB AMG Line Premium	EQB AMG Line Launch Edition	Model prices	Personalisation	Standard equipment	Genuine accessories	Technical data	Additional information
--------	----------------	------------	-------------	--------------	----------------------	-----------------------------	--------------	-----------------	--------------------	---------------------	----------------	------------------------



Bicycle rack

This extremely lightweight bicycle rack is designed to allow you to attach a bicycle to the basic carrier bars. Bicycles can either be attached to the rack once it has been fitted to the roof or, conveniently, before it is fitted. The support frame can also be folded down when not in use to reduce drag when travelling. Suitable for cycles with a max. frame diameter of 98 mm (circular frame tubes) or 110 x 70 mm (oval frame tubes). Please bear in mind your vehicle's permissible roof load. (A0008900293)



Mercedes-Benz roof box 400, opens on both sides

Mercedes-Benz roof box. Capacity approx. 400 litres. Maximum load 75 kg. With handle strip for easier opening and closing. Please bear in mind your vehicle's permissible roof load. (A0008401100)

All the above accessories are subject to availability and compatibility. Please ask your Mercedes-Benz Retailer for more information. Images shown are for illustration purposes only.

Design	Sustainability	Technology	Mercedes-EQ	EQB AMG Line	EQB AMG Line Premium	EQB AMG Line Launch Edition	Model prices	Personalisation	Standard equipment	Genuine accessories	Technical data	Additional information
--------	----------------	------------	-------------	--------------	----------------------	-----------------------------	--------------	-----------------	--------------------	---------------------	----------------	------------------------

[Book a test drive](#)[Buy your EQB](#)[Find a Retailer](#)

Technical data

- Standard

Model	EQB 300 4MATIC		EQB 350 4MATIC	
Motor				
Battery type	lithium-ion high-voltage		lithium-ion high-voltage	
Electric motor type	asynchronous		asynchronous	
Battery capacity	kWh	66.5	66.5	
Power ¹	hp (kW)	228 (168)	292 (215)	
Torque ¹	Nm	370	370	
On-board charger	kW	11 AC 100 DC	11 AC 100 DC	
Emissions standard	EU6		EU6	
Transmission				
Single-speed automatic	●		●	
Performance				
Acceleration 0–62 mph	sec	7.7	6.0	
Top speed	mph	99	99	
Charging time – AC outlet (230 V/13 A) 10–100% ^{2,3} Wallbox (400 V/16 A) 10–100% ² Public rapid charging (100 kW) 10–80% ⁴	30 hrs		30 hrs	
	5 hrs 45 min		5 hrs 45 min	
	32 min		32 min	
Range power consumption combined ^{4,5}	Wh/km	184–187	189–191	
Electric range – WLTP ⁴	miles	250–257	250–257	
		Please see page 37 for more details	Please see page 37 for more details	

¹Figures according to Regulation (EC) No. 595/2009 in the currently applicable version ²Specified voltage and current values refer to network infrastructure and can be limited by the vehicle. Times are from 10–100% charge using a wallbox (three-phase) or standard socket (single-phase) ³If you are planning to charge your Mercedes-Benz plug-in electric vehicle using a 3-pin domestic plug socket you must get a qualified electrician to inspect and sign off the socket to confirm it is safe and suitable to charge your vehicle. Do not use an electric vehicle 3-pin charge cable with an extension cord) ⁴Figures shown are for comparability purposes; only compare with other cars tested to the same technical procedures. Figures may not reflect real life driving results, which will depend upon a number of factors including the starting charge of the battery, factory-fitted options, accessories fitted (post registration), variations in weather, driving styles and vehicle load. Further information about the test used to establish range, power consumption and CO₂ figures can be found at <http://www.mercedes-benz.co.uk/WLTP> ⁵Specified voltage and current values refer to network infrastructure and can be limited by the vehicle. Times are from 10–80% charge using public rapid charging at 100 kW

[Book a test drive](#)[Buy your EQB](#)[Find a Retailer](#)

Technical data

Model	EQB 300 4MATIC		EQB 350 4MATIC	
Weights and capacities				
Kerb weight ⁶	kg	2,105		2,105
Perm. Gross Vehicle Weight	kg	2,535		2,535
Boot capacity – seats up/seats down	kg	495/1,710		495/1,710
Turning circle	m	11.4		11.4
Insurance				
All variants		tba		tba

Insurance ratings may vary depending on model line and specification. Please refer to <http://www.thatcham.org/abigrouprating/> for further details

⁶Mass of the vehicle in running order with at least 90% full fuel tank, plus the mass of the driver (estimated by law at 75 kg), fuel and fluids, equipped with the standard equipment as specified by the manufacturer as well as, where applicable, the mass of the body, cab, trailer coupling and spare wheel(s) as well as tools. Optional extras, additional equipment and accessories can influence the weight, residual payload, rolling resistance, aerodynamics, etc., and therefore also affect the consumption/CO₂ values

[Book a test drive](#)[Buy your EQB](#)[Find a Retailer](#)

Electric range and consumption

Model	Energy Consumption – combined (Wh/km) ^{1,2}	All Electric Range (km)	All Electric Range (miles) ²
EQB 300 4MATIC AMG Line	184	414	257
EQB 300 4MATIC AMG Line Premium	187	403	250
EQB 300 4MATIC AMG Line Launch Edition	183	414	257
EQB 350 4MATIC AMG Line	184	414	257
EQB 350 4MATIC AMG Line Premium	187	403	250
EQB 350 4MATIC AMG Line Launch Edition	183	414	257

Driving Assistance package (code PAY) has no impact on range

¹Specified voltage and current values refer to network infrastructure and can be limited by the vehicle. Times are from 10-80% charge using public rapid charging at 100 kW ²Figures shown are for comparability purposes; only compare with other cars tested to the same technical procedures. Figures may not reflect real life driving results, which will depend upon a number of factors including the starting charge of the battery, factory-fitted options, accessories fitted (post registration), variations in weather, driving styles and vehicle load. Further information about the test used to establish range, power consumption and CO₂ figures can be found at <http://www.mercedes-benz.co.uk/WLTP>



Book a test drive



Buy your EQB



Find a Retailer

EQB AMG Line/AMG Line Premium/AMG Line Launch Edition

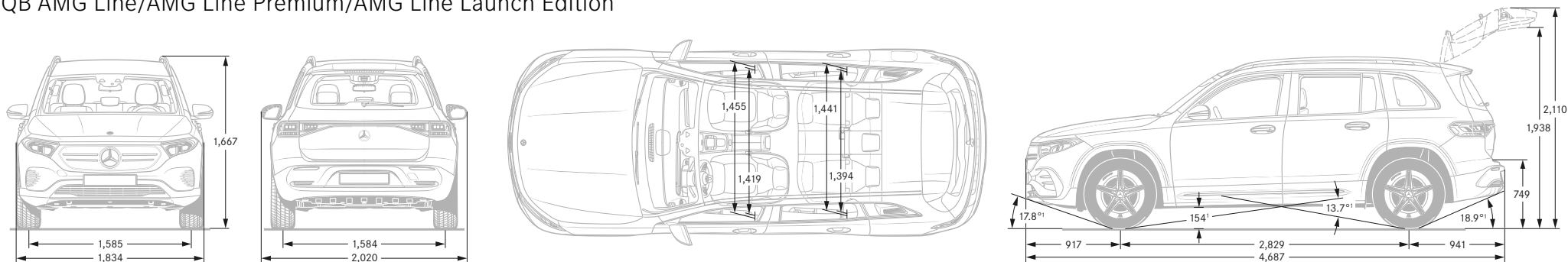

All measurements in millimetres. The dimensions shown are mean values and apply to standard-specification, unladen vehicles

Design	Sustainability	Technology	Mercedes-EQ	EQB AMG Line	EQB AMG Line Premium	EQB AMG Line Launch Edition	Model prices	Personalisation	Standard equipment	Genuine accessories	Technical data	Additional information
--------	----------------	------------	-------------	--------------	----------------------	-----------------------------	--------------	-----------------	--------------------	---------------------	----------------	------------------------



Book a test drive



Buy your EQB



Find a Retailer

Boot dimensions

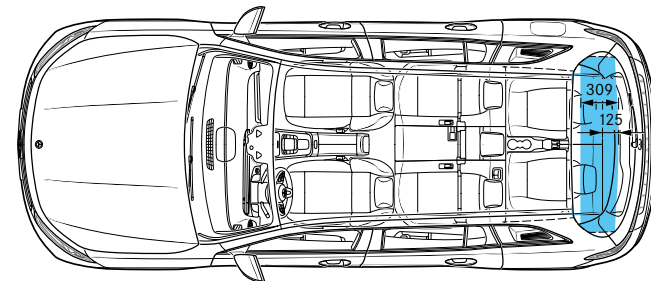
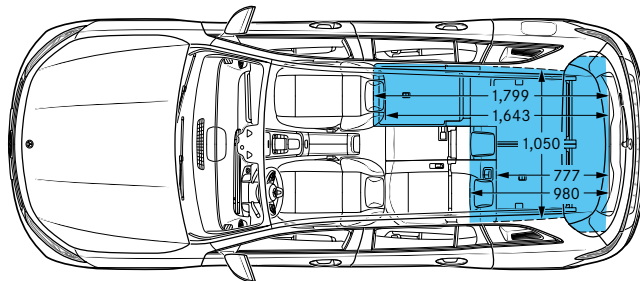
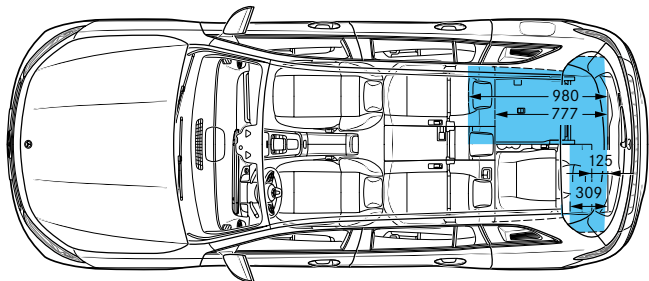
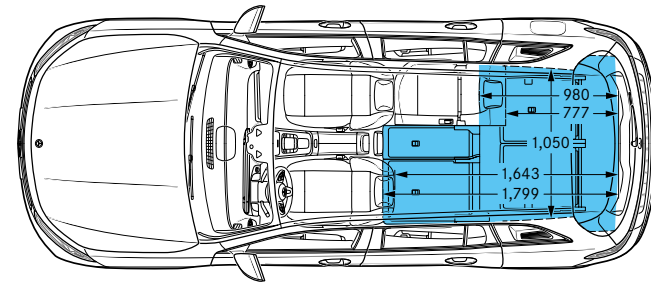
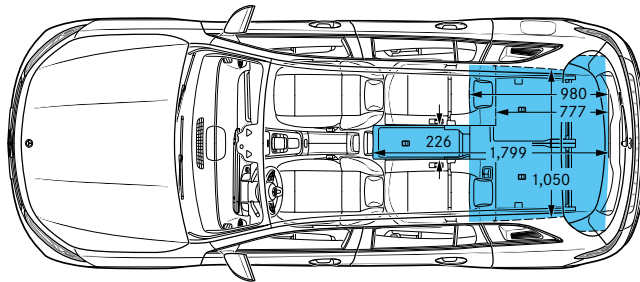
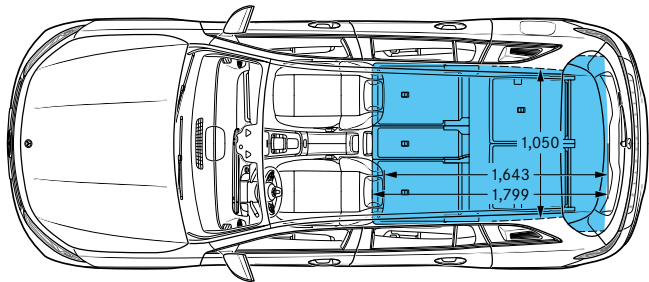

All measurements in millimetres.

Design	Sustainability	Technology	Mercedes-EQ	EQB AMG Line	EQB AMG Line Premium	EQB AMG Line Launch Edition	Model prices	Personalisation	Standard equipment	Genuine accessories	Technical data	Additional information
--------	----------------	------------	-------------	--------------	----------------------	-----------------------------	--------------	-----------------	--------------------	---------------------	----------------	------------------------



Road Fund Licence

All road vehicle registrations are subject to Vehicle Excise Duty (Road Fund Licence), which varies in accordance with the vehicle's CO₂ emissions. A first year rate for each taxation band will apply. The table below shows the bands (A–M) created by the DVLA and the corresponding Road Fund Licence. CO₂ emissions and the relevant Excise Duty are shown on the model pricing page.

Band	CO ₂ emissions (g/km)	First year rate petrol and RDE2 diesel (£)	First year rate all other diesel (£) ¹	First year rate alternative fuel (£)	Electric vehicles		Alternative fuel vehicles		Petrol/diesel vehicles	
					Standard rate (£)	Premium rate (£) ²	Standard rate (£)	Premium rate (£) ²	Standard rate (£)	Premium rate (£) ²
A	0	0.00	0.00	0.00	0.00	0.00	0.00	0.00	0.00	0.00
B	1 to 50	10.00	25.00	0.00	0.00	0.00	155.00	510.00	165.00	520.00
C	51 to 75	25.00	120.00	15.00	0.00	0.00	155.00	510.00	165.00	520.00
D	76 to 90	120.00	150.00	110.00	0.00	0.00	155.00	510.00	165.00	520.00
E	91 to 100	150.00	170.00	140.00	0.00	0.00	155.00	510.00	165.00	520.00
F	101 to 110	170.00	190.00	160.00	0.00	0.00	155.00	510.00	165.00	520.00
G	111 to 130	190.00	230.00	180.00	0.00	0.00	155.00	510.00	165.00	520.00
H	131 to 150	230.00	585.00	220.00	0.00	0.00	155.00	510.00	165.00	520.00
I	151 to 170	585.00	945.00	575.00	0.00	0.00	155.00	510.00	165.00	520.00
J	171 to 190	945.00	1,420.00	935.00	0.00	0.00	155.00	510.00	165.00	520.00
K	191 to 225	1,420.00	2,015.00	1,410.00	0.00	0.00	155.00	510.00	165.00	520.00
L	226 to 255	2,015.00	2,365.00	2,005.00	0.00	0.00	155.00	510.00	165.00	520.00
M	over 255	2,365.00	2,365.00	2,355.00	0.00	0.00	155.00	510.00	165.00	520.00

Some of the model features, optional extras and colours shown may not be available, or may only be available in a different specification, or at a different price

¹Applies to all Mercedes-Benz diesel models which do not comply with RDE (Real Driving Emissions) Step 2 Certified (Euro 6d)

²Premium rate only applicable to vehicles where the list price is over £40,000 including any factory-fitted options, standard UK delivery charge and VAT

Design	Sustainability	Technology	Mercedes-EQ	EQB AMG Line	EQB AMG Line Premium	EQB AMG Line Launch Edition	Model prices	Personalisation	Standard equipment	Genuine accessories	Technical data	Additional information
--------	----------------	------------	-------------	--------------	----------------------	-----------------------------	--------------	-----------------	--------------------	---------------------	----------------	------------------------

Services and insurance

Mercedes-Benz ServiceCare

We believe that servicing costs should be as flexible and affordable as possible for your EQB, which is why we offer ServiceCare, an easy way to budget for all your servicing costs. It spreads your bills into manageable payments based on whether you have a new or used Mercedes-Benz.

With ServiceCare we guarantee the price of parts and labour for up to four services and safeguard against any further inflation.

You can choose either to add your servicing costs into your monthly spend or pay the full amount in a one-off payment, giving you peace of mind that they are taken care of for the period of the plan.

[Click here for more information](#)

Warranty and breakdown cover

Every Mercedes-Benz comes with a three-year unlimited mileage warranty against manufacturing or material defects¹ and up to 30 years warranty against perforation due to corrosion from the inside out.² What's more, it's also covered by Mercedes-Benz Roadside Assistance – a unique package comprising up to 30 years pan-European breakdown assistance.²

Battery Warranty

The battery comes with an eight-year 100,000-mile warranty.

Motor Insurance

We know that once you have chosen your Mercedes-Benz you can't wait to drive it – that's why we created First Cover³. It gives you 7 days' free comprehensive Motor Insurance when you buy a new or used vehicle from a Mercedes-Benz Retailer. We will also send you a quote for annual cover, so you can enjoy the same peace of mind all year round.

[Apply for First Cover](#)



¹Applies to vehicles sold by Mercedes-Benz in the UK to its franchised Retailers

²Subject to full Terms and Conditions, dependent on date of registration, available upon request

³Terms and Conditions apply. We are an independent intermediary dealing with selected insurers in respect of annual insurance



Effective from February 2022 Production. Information correct at time of publication 01.04.2022.
Prices and specifications are subject to change without prior notice.
MBX243PL/0422

