

# RENAULT ZOE E-TECH

100% electric



4th October 2022

# **new perspectives**

Everything makes you want to follow Renault Zoe E-Tech 100% electric: its new refined design, its driving range of up to 239 mile WLTP\* and its fast charging capabilities with combined charging system (CCS) facilitates your mobility. The easy link multimedia system and the My Renault application provides you with a connected experience. Zoe E-Tech 100% electric takes on a new course.



**up to 239 miles  
WLTP\* driving  
range**



**fast charging  
(CCS) available**

**connected  
system**

**elegant  
design**

**12 advanced  
driving  
assistance  
systems**

\* WLTP (Worldwide Harmonised Light Vehicle Test Procedures): this new protocol provides results much closer to those found in daily use compared with the NEDC protocol.



ZOE

## elegant design

Read about all the reasons why Zoe E-Tech 100% electric is a success, with its assertive character, fluid lines and C-shaped LED headlights. And discover its new, more premium identity with its warm titanium grille and front fog light surrounds. The warm titanium motifs adorning its door sticker and the 17" dark diamond-cut alloy wheels give it a modern fashionable urban chic style.\* Its LED lights at the rear and its new shark antenna confirm its sense of detail.

\*Only available on iconic boost charge version



# driving pleasure reinvented

The Renault Zoe E-Tech 100% electric passenger compartment has been redesigned: warm titanium touches on the dashboard and upholstery. An enjoyable experience in the cabin, with elegant design while maintaining environmental responsibility thanks to the embossed recycled upholstery. Drive it with ease thanks to its 10" digital cluster that displays essential information right before your eyes and on the 9.3" central screen that provides real-time updated navigation information with Tomtom. With Android Auto™ and Apple CarPlay™ replication, listen to your playlists and browse your favourite applications. Go even further with the My Renault application: plan your trips, send your destination to the vehicle remotely, and locate available charging stations around you. Make your life easier with 100% reinvented mobility.

Android Auto™ is a Google Inc. brand.  
Apple CarPlay™ is an Apple Inc. brand.





Mises à jour automatiques offertes en Portugal.  
Confirmez-vous ce choix de pays ?

Oui Plus tard Non



Fréq. Téléphone

ANTENA 1  
O Futuro Virgula - Efeito Borboleta 2/2

Sources Med DM Connecter

88 21.6 21.6 21.6

eco A/C

Three circular climate control buttons with digital displays showing temperature and fan speed.

USB 1 2

Two USB ports for charging devices.

**up to 239 mile range**

With Renault Zoe E-Tech 100% electric, the emphasis is on next-generation performance. Committed to pushing the boundaries of electromobility, the design takes things even further: improved air turbulence management, energy recovery, efficient driving mode. Its new platform houses a 52 kWh battery for a range of up to 239 mile. <sup>(1)</sup>







#### **aerodynamic design**

Renault Zoe's front end panel has two air inlets which channel flow to reduce turbulence. This technology, combined with a redesigned body under-structure, makes the vehicle as aerodynamic as possible.

#### **regenerative braking**

With Renault Zoe, the energy produced when decelerating or every time the brake is used recharges your battery. This can add up to 10% more range in urban environments.

#### **eco mode**

In urban environments, switching to eco-mode further optimises the battery's performance. Less sudden braking thanks to increased deceleration. That means more effective energy recovery and maximum range.

#### **driving ranges<sup>(1)</sup>**

**52 kWh battery:**  
– up to 239 mile

(1) WLTP (Worldwide Harmonised Light Vehicle Test Procedures): this new protocol provides results much closer to those found in daily use compared with the NEDC protocol.

1. charging on home charging
2. charging on public charging



**charging  
made easy**

You have continuous access to a broad range of customised solutions for charging at home, at work, on the road or elsewhere. Renault Zoe is delivered with a mode-3 type cable that can be used with a domestic<sup>(1)</sup> or a public charging station. With the **My Renault application**, check your battery's charge level from your mobile.





#### charging at home, at work or elsewhere

Charge Renault Zoe easily on the domestic grid using a domestic charging station<sup>(1)</sup>, a reinforced domestic socket or a standard domestic socket<sup>(2)</sup>. With the **My Renault application**, check your driving range at any time, start your charging remotely or schedule it to start at off-peak times.

At home, **Mobilize Power Solutions** offers you a personalised range of charging stations and sockets, helping with installation and maintenance.

#### on-street charging

An evening at the cinema? Going to the supermarket? With the **My Renault application**, locate the public charging points closest to your destination. For longer journeys, get up to 90 mile of range in 30 minutes at a rapid (CCS) charging point.

type of facility	charge power <sup>(3)</sup>	cable to be used	charging time <sup>(3)</sup> 52 kWh battery			
			30 mile	150 mile	239 mile	
domestic charging point <sup>(1)</sup>	7.4 kW	mode 3 cable included in the purchase		1 hr 15 min	5 hrs 30 min	9 hrs 30 min
reinforced domestic socket	3.7 kW	standard mode 2 cable optional (3-pin charger, accessory available)		2 hrs 45 min	12 hrs	19 hrs
standard domestic socket <sup>(2)</sup>	2.3 kW	standard mode 2 cable optional (3-pin charger, accessory available)		5 hrs	23 hrs	32 hrs
public fast charging point	50 kW	cable attached to the station		15 min	0 hrs 55 min	1 hr 30 min
public charging point	22 kW	mode 3 cable included in the purchase		30 min	1 hr 50 min	3 hrs

<sup>(1)</sup> Mobilize Power Solutions offers. For more information about Mobilize services, go to the Mobilize services page. For more information about recharging, call 0 800 12 34 56 (to be localised by countries). <sup>(2)</sup> 3-pin charging should only be used occasionally. <sup>(3)</sup> maximum power and charging times are based on moderate weather conditions (20 °C).

# 12 advanced driving assistance systems

Renault Zoe E-Tech 100% electric is equipped with twelve innovative advanced driving assistance systems, including the selection below. Benefiting from these proven technologies, drivers can take to the road with complete peace of mind.



## regenerative braking

Regenerative braking allows the battery to charge by recovering energy as soon as you take your foot off the accelerator. In mode B, this braking is more intense and allows you to drive in a more economical way that requires less use of the brake pedal.

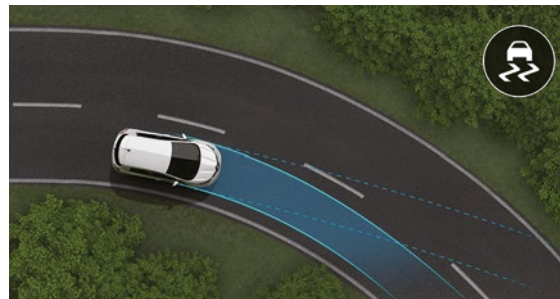

## electronic stability control

The system allows you to maintain control of the vehicle in critical driving situations: obstacles or loss of grip on a bend.

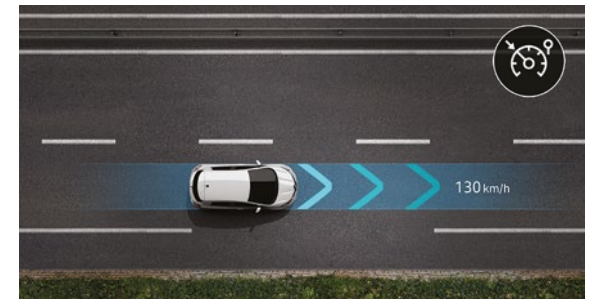

## cruise control/speed limiter

Control your speed with the buttons on the steering wheel and set a maximum speed to comply with traffic regulations and avoid any infractions.

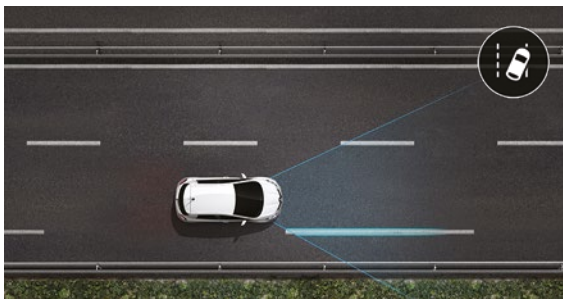

## lane departure warning

The system informs the driver of unintended crossings of a solid or broken line, using a camera located on the windscreen, behind the rear-view mirror.

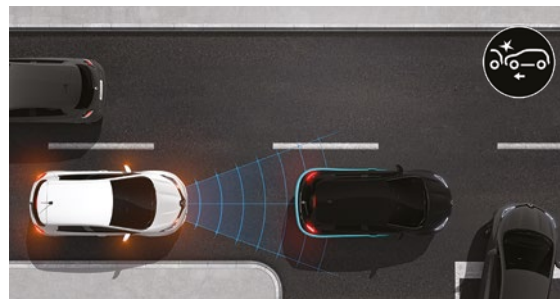

## automatic emergency braking

Active up to 80 km/h, it detects vehicles approaching head-on and stops yours in the event of danger. Driving in the city has never been so safe, day or night.



## hill start assist

Combined with ESC, hill start assist maintains brake pressure automatically for 2 seconds to give you time to lift your foot from the brake pedal and press the accelerator. The system activates when the slope exceeds 3%.

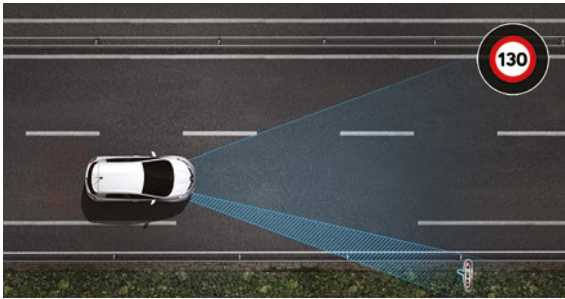

#### traffic signal recognition

Be alerted if the speed limit is exceeded. The camera-equipped system gathers, compares and analyses signalling data with information provided by mapping and keeps you informed via the instrument panel. You can also record the maximum speed detected to adjust your speed limiter.

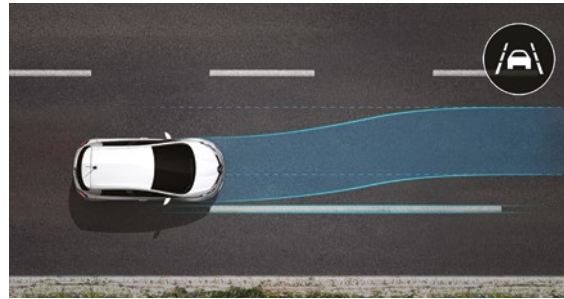

#### lane keeping assist

Active between 40 m/h and 80 m/h, this system corrects the steering wheel to bring the vehicle back into lane if you ever cross a continuous or broken line without activating your indicator.

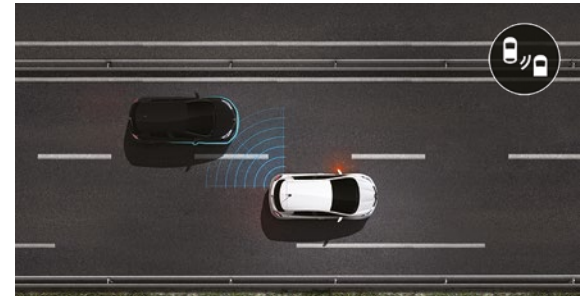

#### blind spot warning

Active above 10 m/h, this system uses warning lights to alert you to the presence of vehicles that are not visible in your field of vision.

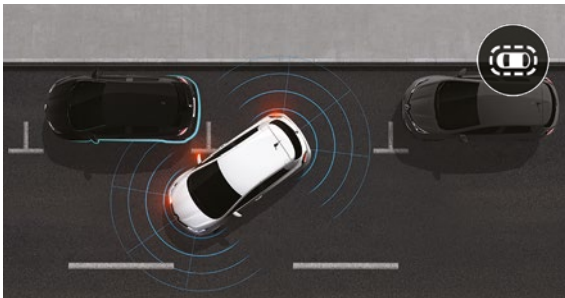

#### front and rear parking sensors

Radar sensors facilitate your manoeuvres by warning you with sound and visual signals of the proximity of obstacles in front of and behind you.



#### side parking sensors

Radar sensors facilitate your manoeuvres by warning you with sound and visual signals of the proximity of obstacles in front of and behind you.

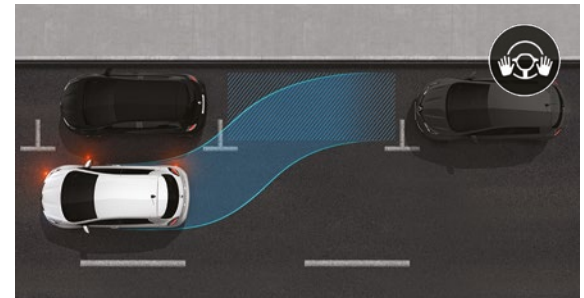

#### hands-free parking

This system makes it easier to park. Your vehicle handles both finding a parking spot and steering. All you need to manage is the speed.







wireless phone charger not included.

## techno

### driving and advanced assistance systems driving assistance

- cruise control/ speed limiter, with steering wheel controls
- customisable 10" colour driver's display
- easy park assist, front and rear parking sensors, with rear view camera
- lane departure warning with lane keep assist
- lane keep assist

### comfort + storage

- automatic climate control with eco function
- heated steering wheel
- heated driver and front passenger seats
- heated, electrically adjustable folding door mirrors
- renault hands-free card
- glovebox with slow-opening flap
- 1.5l bottle holders in front doors

### technology

- easylink 9.3" with Navigation - compatible with Android Auto™ and Apple CarPlay™
- 2 usb ports for rear seats
- 12v outlet under the dashboard

### renault connect, connected services

- 4G connected vehicle with data pack included for 3 years
- connected navigation services
- connected services on the MY Renault app: battery charging status, passenger compartment preconditioning

### exterior design

- 16" diamond-cut Seidon alloy wheel
- full LED headlights with c-shape daytime running lights
- tinted rear windows and rear screen

- shark antenna
- hot stamped grille with warm titanium detailing
- fog light surrounds with warm titanium detailing
- ZOE badging with golden E

### interior design

- leather gear lever with b mode
- recytex recycled textile dashboard and doorpanel
- soft armrests in door panel
- heated front seats, in dark grey recycled material (PET) with embossing
- driver seat with longitudinal adjustment and backrest inclination
- sunvisor and mirror (no light)
- 3 full rear head rests

### ev specific equipment

- eco mode can be activated via specific button
- odometer, eco-meter and battery gauges integrated into the instrument panel
- scheduled charging and heating/ air conditioning using the easylink multimedia system
- regenerative braking indicator
- chameleon single- or three-phase charged, adaptive from 2kW to 22kW
- mode 3 charging cable, 6.5m, black

## techno boost charge (in addition to techno)

### ev specific equipment

- Combo CCS DC charger (50kW)

## iconic boost charge (in addition to techno boost charge)

### exterior design

- warm titanium door stripping
- 17" diamond-cut alloy wheel Elington with black and gold detailing with 17" Michelin Primary 4-E tyres



## upholstery

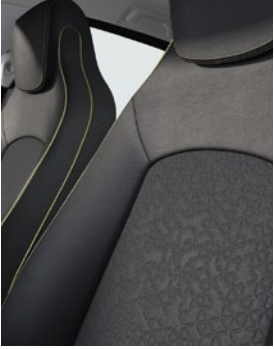

dark grey recycled/  
imitation leather textile  
seats with motif (techno  
& iconic)

## hubcap and rims



16" seidon diamond-cut  
alloy wheels (techno)



17" Elington black &  
warm titanium varnish  
alloy wheels (iconic)

# color palette



glacier white (standard)



shadow grey (mp)



celadon blue\* (mp)



diamond black (mp)



midnight blue (mp)



flame red\* (mp)



aconite (mp)

mp: metallic paint.  
Photos not contractually binding.  
\*colour only available on techno trim.

# engines

	<b>R135</b>
Battery type (kWh)	52
Number of seats	5
<b>Driving range and consumption</b>	
Certified driving range in WLTP cycle (mile) <sup>(1)(2)</sup>	239 (Techno) / 223 (Iconic)
Certified consumption in combined cycle (kWh/mile)	280
Wheel size of certified version <sup>(3)</sup>	16"
Actual average summer/winter driving range (mile)	230/150
<b>Engine</b>	
Electric engine technology	synchronous with coiled rotor
Peak power kW EEC (hp)/at rated power (rpm)	100 (135) / 4,200 to 11,163
Maximum torque Nm EEC (Nm) / at maximum rated power (rpm)	245/1,500 to 3,600
<b>Battery</b>	
Usable capacity (kWh)	52
Technology	lithium-ion
Total voltage (V)	400
Number of modules/cells	12/192
Battery weight (kg)	
<b>Charging time<sup>(4)</sup></b>	
Charger	AC single- or three-phase adaptive from 2 kW to 22 kW and DC up to 50 kW
2.3 kW home socket (single-phase 10A) (0-100%)	32 hrs
3.7 kW Green'Up / Wallbox socket (single-phase 16A) (0-100%)	19 hrs
7.4 kW Wallbox (single-phase 32 A) (0-100%)	9 hrs 30 min
11 kW charging point (three-phase 16 A) (0-100%)	6 hrs
22 kW charging point (three-phase 32 A) (0-100%)	3 hrs
50 kW DC rapid charging point (0-80%)	1 hr 10 min
<b>Gearbox</b>	
Gearbox type	gearbox with a single gear ratio speed reducer
Number of forward gears	1
<b>Performance</b>	
Maximum speed (m/h)	90
0-30 m/h – 0-62 m/h – 50-75 m/h (s)	3.6 - 9.5 - 7.1
SCx	0.75
<b>Steering</b>	
Assisted	yes (electric)
Turning circle between kerbs (m)	10.56
Number of turns lock to lock	2.73
<b>Wheels and tyres</b>	
Standard wheel rims (")	16" (techno) 17" (iconic)
Tyre Dimensions 16" – Michelin Primacy 4	195/55 R16 91T
Tyre Dimensions 17" – Michelin Primacy 4	215/45 R17 91V (front) 205/45 R17 88V (rear)
<b>Braking</b>	
Front: plain disc (PD), ventilated disc (VD) diam. (mm)	VD Ø280
Rear: drum (D), plain disc (PD), ventilated disc (VD) diam. (mm)	VD Ø260
<b>Weight (kg)</b>	
Unladen kerb weight	1,502
Gross train weight (GTW)	1,988
Max. gross vehicle weight (MGVW)	1,988
Within the limit of the allowable MGVW on the front/rear	1,048 / 940
Payload (techno and iconic versions, all options)	486
Max. braked/unbraked trailer weight	not authorised / not authorised

(1) WLTP (Worldwide Harmonized Light Vehicle Test Procedures): this new protocol provides results much closer to those found in daily use compared to the NEDC protocol. (2) in WLTP certification, the value corresponds to the vehicle version that has obtained the most optimal value. (3) the size of the wheel rims may affect the vehicle's driving range. (4) the charging time and driving range recovered depend on the temperature, wear of the battery, power delivered by the charging point, your driving style and your charge level.

# dimensions & volumes

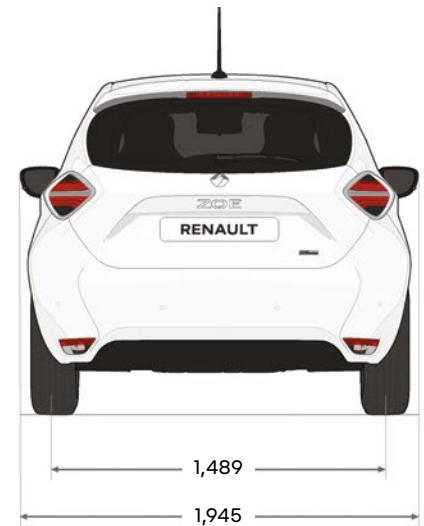
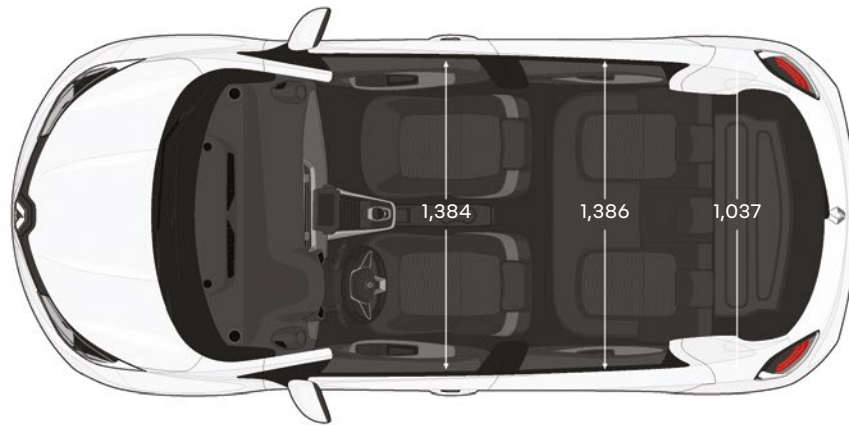
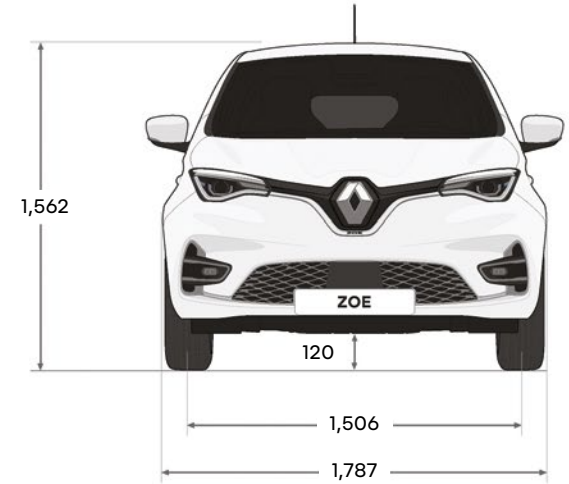
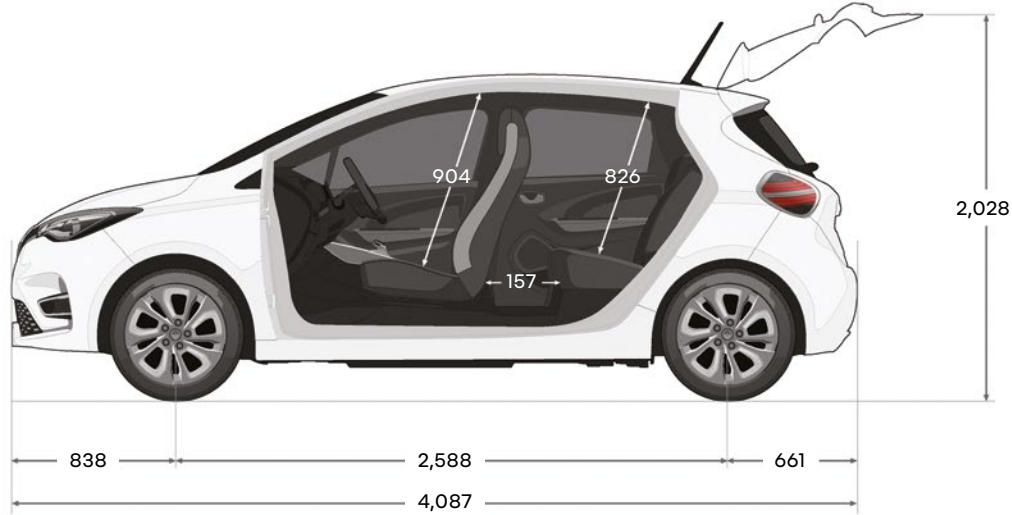

## Boot volume - VDA standard (dm<sup>3</sup>)

Boot capacity under parcel shelf	338
Boot volume, rear bench seat folded down	1,225

dimensions in (mm).

## accessories

### 1. False floor for cable storage and stainless steel boot sill.

Fully integrated into the boot shape, the false floor offers several compartments designed to hold two charging cables. No more cables lying around or dirt on the

bottom of the boot: the false floor raises the bottom of your boot, making it easier to access the objects inside it. The removable floor is hinged and features a handle to make accessing the contents easier.



**2. Front armrest.** This feature improves driving comfort and offers additional storage space. Room for storing coins (e.g. tokens and change). Available in three finishes: black fabric, Recytex fabric, black leatherette.

**3. 3-pin (domestic) charging cable.** Ensure you can charge on the go with the 3-pin domestic charging cable. This allows you to charge your Zoe on the move without access to a wall box.

**4. Premium textile floor mats.** Premium mat with elegant finish. They provide full protection for the floor in the passenger compartment. Custom-made and specially designed for the vehicle, they are easily attached using two securing clips and don't interfere with the pedals. Easy to clean.

**5. Illuminated door sills.** Elegance and modernity whenever a door is opened. White time-delayed lighting on your sills turns heads day or night. Their aluminium-look finish, featuring a Renault logo, also protects the entrances to your vehicle. Sold in pairs.



# equipment and options

	techno	techno boost charge	iconic boost charge
<b>safety</b>			
2 driver airbags + 2 passenger airbags (single-volume front, chest side)	▪	▪	▪
hill start assist	▪	▪	▪
anti-lock braking system (ABS) with emergency brake assist (EBA)	▪	▪	▪
electronic stability programme (ESP) with anti-slip regulation (ASR) and understeer control logic (UCL)	▪	▪	▪
front fog lights	▪	▪	▪
automatic headlights and windscreen wipers	▪	▪	▪
automatic activation of hazard lights upon emergency braking	▪	▪	▪
rear side height-adjustable curved headrests	▪	▪	▪
central rear headrest	▪	▪	▪
radio frequency central locking	▪	▪	▪
automatic full central locking when driving	▪	▪	▪
2 seats with isofix attachments (marking and guidance)	▪	▪	▪
tyre pressure monitoring system	▪	▪	▪
tyre inflation and repair kit	▪	▪	▪
Zoe voice' pedestrian warning beep: 3 sounds with button on the dashboard	▪	▪	▪
front and rear seat belt reminder	▪	▪	▪
centre rear seatbelt	▪	▪	▪
electric parking brake	▪	▪	▪
<b>driving and advance driving assistance</b>			
cruise control/ speed limiter, with steering wheel controls	▪	▪	▪
customisable 10" colour driver's display	▪	▪	▪
front and rear parking sensors	▪	▪	▪
rear view camera	▪	▪	▪
hands free parking/ park assist	▪	▪	▪
lane departure warning	▪	▪	▪
lane keep assist	▪	▪	▪
blind spot warning	▪	▪	▪
automatic high-beam/ dipped-beam headlight activation	▪	▪	▪
traffic sign recognition	▪	▪	▪
over speed prevention	▪	▪	▪
electrochrome door mirror (day/night dipping) with light and rain sensors	▪	▪	▪
auto dimming rear view mirror with rain sensor	▪	▪	▪
<b>comfort</b>			
automatic climate control with eco function	▪	▪	▪
heated steering wheel	▪	▪	▪
electric front windows with one touch and electric rear windows	▪	▪	▪
renault hands-free card	▪	▪	▪
air quality sensor (AQS)	▪	▪	▪
heated driver and front passenger seats	▪	▪	▪
heated, electrically adjustable folding door mirrors	▪	▪	▪
<b>storage</b>			
height and reach adjustable steering wheel	▪	▪	▪
glovebox with slow-opening flap	▪	▪	▪
1.5l bottle holders in front doors	▪	▪	▪
split-folding rear bench	▪	▪	▪

	techno	techno boost charge	iconic boost charge
<b>technology</b>			
easylink 9.3" with Navigation - Radio and Navigation with 9.3" high resolution touch screen - Compatible with Android Auto™ and Apple CarPlay™ - 6 speakers, Bluetooth® 2 USB, 1 AUX port - Connected navigation services - Auto-Update Service	▪	▪	▪
Bose® sound system, Android Auto™ compatibility, DAB, 2 neodymium bass speakers, 2 rear wide-band speakers, 2 neodymium tweeter speakers and an Nd™ Richbass™ bass speaker in a 6.2 litre individual Waveguide box behind the boot bar	▪	▪	▪
digital radio reception (DAB + traditional FM/AM)	▪	▪	▪
2 usb ports for rear seats	▪	▪	▪
12v outlet under the dashboard	▪	▪	▪
<b>Renault connect, connected services</b>			
4G connected vehicle with data pack included for 3 years	▪	▪	▪
connected navigation services - 3 years included: google search for places of interest, live traffic info, weather (depending on country)	▪	▪	▪
connected services on the MY Renault app: battery charging status, passenger compartment preconditioning	▪	▪	▪
auto-update - 3 years included (for compatible easylink systems): automatic wireless updating of the multimedia system, for automatic system improvements. For easylink systems with navigation: map also updated automatically	▪	▪	▪
<b>ev specific equipment</b>			
eco mode can be activated via specific button	▪	▪	▪
odometer, eco-meter and battery gauges integrated into the instrument panel	▪	▪	▪
scheduled charging and heating/ air conditioning using the easylink multimedia system	▪	▪	▪
regenerative braking indicator	▪	▪	▪
chameleon single- or three-phase charged, adaptive from 2kW to 22kW	▪	▪	▪
Combo CCS DC charger (50kW)	-	▪	▪
mode 3 charging cable, 6.5m, black	▪	▪	▪
mode 2, 3-pin (domestic) charging cable	accessory option	accessory option	accessory option
<b>exterior design</b>			
full LED headlights with c-shape daytime running lights	▪	▪	▪
body-coloured door handles	▪	▪	▪
body-coloured door mirrors	▪	▪	▪
tinted rear windows and rear screen	▪	▪	▪
shark antenna	▪	▪	▪
hot stamped grille with warm titanium detailing	▪	▪	▪
fog light surrounds with warm titanium detailing	▪	▪	▪
ZOE badging with golden E	▪	▪	▪
warm titanium door stripping	-	-	▪
16" diamond-cut alloy wheel Seidon with 16" Michelin Primary 4-E tyres	▪	▪	-
17" diamond-cut alloy wheel Elington with black and gold detailing with 17" Michelin Primary 4-E tyres	-	-	▪
<b>interior design</b>			
sunvisor and mirror (no light)	▪	▪	▪
leather gear lever with b mode	▪	▪	▪
recytex recycled textile dashboard and doorpanel	▪	▪	▪
soft armrests in door panel	▪	▪	▪
heated front seats, in dark grey recycled material (PET) with embossing	▪	▪	▪
driver seat with longitudinal adjustment and backrest inclination	▪	▪	▪
3 full rear head rests	▪	▪	▪
<b>options</b>			
non-metallic paint	▪	▪	▪
metallic paint	o	o	o
metallic paint i.d. paint	o	o	o

▪ = standard. o = optional. - = unavailable. \* please contact your sales advisor for more details on the materials used. All seats mentioned as being leather in this document are composed of real leather and coated textile. Android Auto™ is a Google Inc. brand. Apple CarPlay™ is an Apple Inc. brand. Google is a brand of Google LLC.



# lexicon

## **E-Tech**

100% electric, hybrid or rechargeable hybrid technology developed by Renault.

## **regenerative braking**

Energy recovery system during braking, which increases the vehicle's driving range: whenever the vehicle slows down, part of its kinetic energy is converted into electricity. The battery recharges when the driver lifts their foot off the accelerator pedal or presses slightly on the brake pedal.

## **reinforced domestic socket**

A home charging solution that is more efficient than a simple domestic socket. Allows for more powerful (3.2kW for a reinforced socket vs 2.3kW for a standard socket) and more secure charging (fitted with a differential circuit breaker).

## **domestic charging point**

Delivers a much higher intensity than a standard domestic socket, for more efficient and faster charging. It enables safer home charging thanks to its systems for controlling charging and protecting against overvoltage.

## **flexi-charger**

Charging cable that can be used to plug a car into a domestic power socket. Designed for occasional home charging, the flexi-charger should preferably be plugged into an electrical socket connected to a specific earth connection.

## **mode 2**

For domestic use, this cable is needed to charge an electric vehicle using conventional sockets.

## **mode 3**

This cable is needed to recharge electric vehicles via a Wallbox or at public charging points.

## **useful capacity**

Amount of energy contained in the battery that can be used by the vehicle. Value expressed in kilowatt hours (kWh).

## **kWh**

Abbreviation for kilowatt hours. Unit of energy which corresponds to 1 kW of power consumed over one hour.

## **kW**

Abbreviation for kilowatts. Unit used to measure the power of a vehicle's engine, whether it is electric or powered by an internal combustion engine. The kilowatt can also measure the direct current (DC) or alternative current (AC) charging power.

## **AC charge**

Low to medium power AC charging (max. 22kW). This is the charging method most commonly found in homes or at most public charging points.

## **DC charge (CCS)**

Rapid direct current charging (50kW minimum). Requires a specific fast charging station, available only on the public network. Boost charge versions have DC charge capability.

## **My Renault**

Renault application connected to your vehicle that may be downloaded to your phone from Google Play or the App Store. You can use it to locate nearby charging stations, find your vehicle, schedule charging and plan your journey in advance, as well as displaying remaining driving range and pre-setting the temperature of the passenger compartment.

# recycling for a sustainable future

By choosing Renault Zoe E-Tech 100% electric, you are taking action with Renault for a sustainable future. The entire life cycle of the vehicle is optimised to reduce our footprint. This goes from the inclusion in the design of 33% of recyclable materials, to the recycling of batteries to give them several lives.

## responsible batteries

The low-carbon batteries that equip Renault Zoe E-Tech 100% electric are aimed at reducing the CO2 footprint of manufacturing, in partnership with suppliers. These batteries can be recycled in the middle of the life cycle as mobile solutions for boats, refrigeration systems or airport equipment.

In 2018, Renault Group also launched Advanced Battery Storage (ABS), a stationary storage solution for electricity. This enables solar or wind energy to be stored in batteries that no longer meet the requirements of an electric car. While extending its life from 10 to 15 years, the Renault Zoe battery thus becomes the best ally of green energies.

Recycling at the end of life is the final stage. The aim is to recover as many reusable resources as possible by consuming a minimum of energy, to manufacture new batteries that your Renault Zoe will benefit from.



## recycled materials

When you sit inside, the upholstery you sit on is completely made of woven recycled material. Up to 8 m<sup>2</sup> of recycled textiles are distributed throughout the passenger compartment over the seats, the door panels and the dashboard panel. For the entire vehicle, recycled materials represent 22.5 kg. 100% of them come from plastic bottle fibres. With over 90% recyclable materials, Renault Zoe E-Tech 100% electric contributes to the ecological transition.



# Mobilize: services designed to make your electric life easier

Enjoy a completely practical and fully efficient electrical experience: installation of a charging station in your home as soon as you purchase the vehicle, support services delivered via your mobile, card for accessing and paying for the use of European charging stations.

## **Mobilize power solutions, installation of home charging solutions**

Order your home charging solution when you purchase your vehicle. Whether you are a tenant or a home-owner, whether you live in an apartment block or in a house, we have a solution that will meet your needs – with or without financing. Installed even before your car is delivered to you, this is the best way to start your electric life.

## **simplified purchasing process**

Using an innovative tool, you enjoy a fixed price – with no additional costs – for the purchase and installation of your charging point. Thanks to geolocation, there's no need to make an on-site appointment – we can schedule a simple virtual visit with you so we can check that your electrical installation is in compliance. The order is made online, with signature and payment of the instalment by SMS.

## **peace of mind**

Before, during and after installation, our experts are available to help.

## **With Mobilize Charge pass, easier location of charging points and payment**

Charge your electric vehicle easily on the largest European network of public charging points. When you're on the go, immediately find out where the nearest available charging station is via the My Renault application, follow the route indicated and start charging with your pass.

## **pay with complete peace of mind**

When your vehicle has finished charging, the amount to be paid is debited directly from the bank account associated with the Mobilize Charge Pass. With Mobilize Charge pass, you always have a convenient charging solution.



# Renault care service

We are always at your side to make life easier and save you time with the maintenance of your Renault: online quotes and appointments, fixed price packages, maintenance contracts, insurance and assistance, personalised My Renault programme... Take advantage of our simple and fast solutions tailored to your needs.

## **your first steps**

All the information you need can be found:

- on our websites: our ranges of products/services/finance, book a test, etc.
- in our dealership network: meet our sales and technical teams.

## **Renault care service, 100% cover**

Guard against the unexpected with Renault extended warranties, insurance policies and assistance, which are always there for you.

## **My Renault: your vehicle's connected application**

View a record or reminder of maintenance dates, book an appointment at the dealership, view the e-guide and numerous video tutorials on the functions of your vehicle. Launch your vehicle's charging and air conditioning remotely and make your day-to-day mobility easier with five years of connected services included! And after each service at the Renault workshop, view your battery's capacity directly in the application.

## **Renault care service, worry-free maintenance**

Our Renault care service maintenance contracts and fixed price packages offer you the benefits of a bespoke all-inclusive package.

## **maintained performance**

Your Renault's electric battery is guaranteed for 8 years or 100,000 mile with a minimum capacity of 70%. You will receive free assistance in the event of battery failure during its warranty period.

## **resale made easy**

Resale is made easy: full sale of the vehicle, including battery. Beyond 8 years, Renault offers a battery warranty extension package for even more peace of mind.

## **accessories, your customised Renault**

Our range of accessories contains everything you need to make your vehicle even more attractive, practical, comfortable and customised.

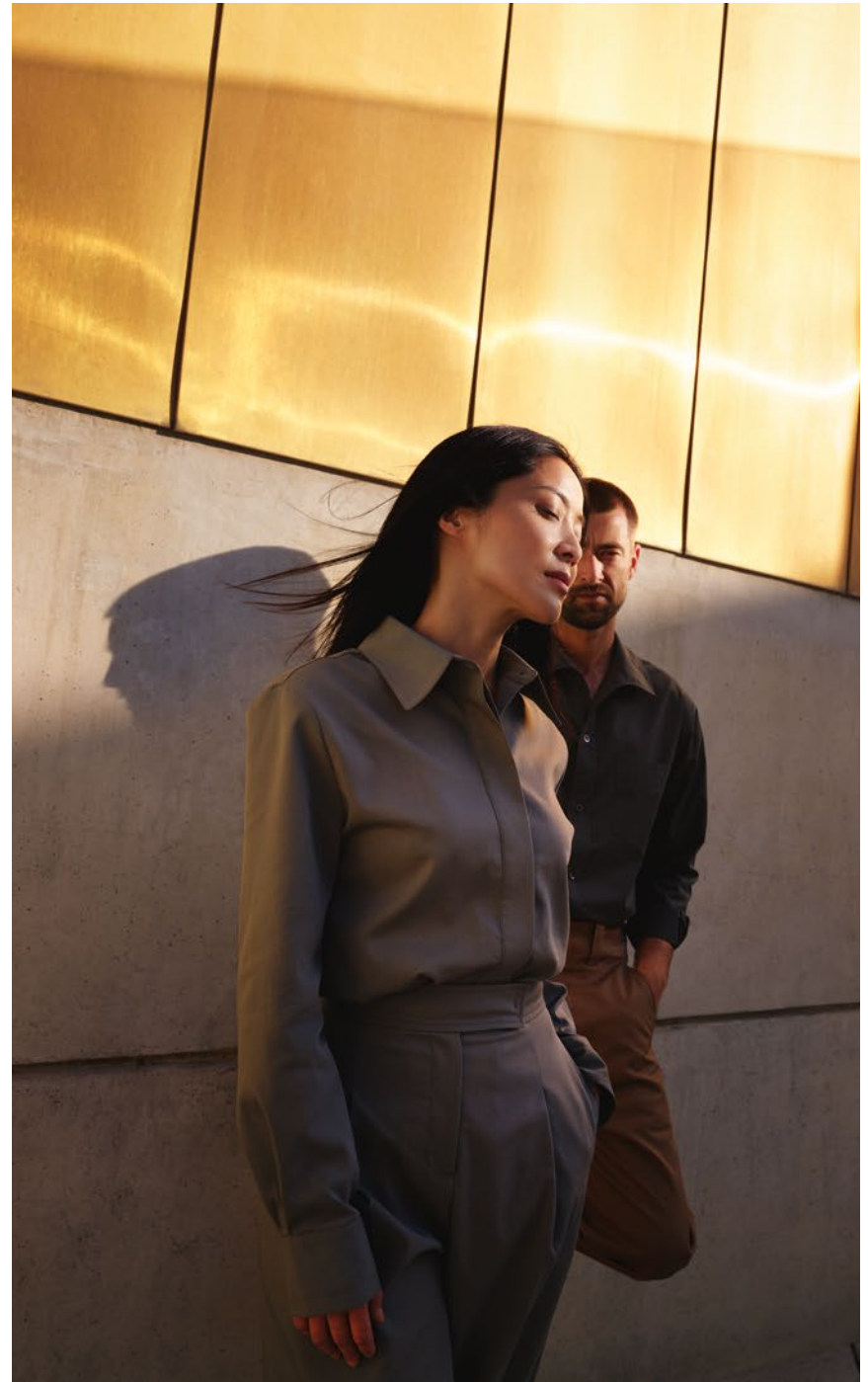

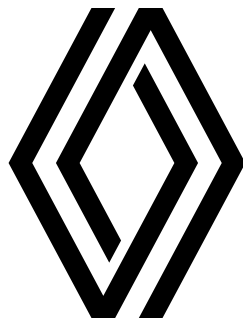

## configure and order Renault Zoe on [www.renault.co.uk](http://www.renault.co.uk)

Every precaution has been taken to ensure that the contents of this publication were accurate and up-to-date at the time of printing. This document was created using pre-production models and prototypes. In line with its policy of continuous product improvement, Renault reserves the right to modify the specifications, vehicles and accessories described and featured at any time. Any such modifications are communicated to Renault dealers as quickly as possible. Depending on the country of sale, versions may differ and some equipment may be unavailable (standard, optional or accessories). Please contact your nearest dealer for the latest information. For technical printing reasons, the colours featured in this document may differ slightly from those of the actual paintwork or interior trim. All rights reserved. Reproduction in any format and by any means of all or part of this publication is prohibited without prior written authorisation from Renault.

Publicis - photo credits: he & me, Cream, ©Renault Marketing 3D-Commerce, RCD, Pagécran - Online only - October 2022.

Renault s.a.s., a société par actions simplifiée (French simplified joint-stock company) with share capital of €533,941,113/122-122 bis avenue du Général Leclerc 92100 Boulogne-Billancourt cedex - Nanterre Trade & Companies Register B 780 129 987/Tel.: 0806 00 20 20.