

TRITON



SWEAR BY IT



GLS DOUBLE CAB

THE KEENLY AWAITED TRITON 4WD TURBO DIESEL HAS ARRIVED WITH ALL THE POWER, SPACE AND COMFORT YOU COULD HOPE FOR IN A GRUNTY WORK UTE OR OFF ROAD RECREATIONAL WAGON. THE 2.8 LITRE, INTERCOOLED TURBO DIESEL DEVELOPS 92KW @ 4000 RPM AND 294NM OF TORQUE AT 2000 RPM. THE GLS IS ALSO AVAILABLE IN A POWERFUL 3.0 LITRE V6 PETROL ENGINE. VERSATILE STYLING, INTERNAL STORAGE OPTIONS, PLENTY OF SAFETY AND SECURITY FEATURES MAKE IT THE PERFECT ALL ROUND PEOPLE AND CARGO MOVER.



GLX CLUB CAB

CLUB CAB HAS EXTRA ROOM TO STORE TOOLS AND OTHER VALUABLES, EITHER BEHIND THE SEATS OR IN THE HIDDEN STORAGE COMPARTMENT. YOU CHOOSE THE TRITON TO SUIT ALL YOUR PERSONAL AND WORK NEEDS. CHOOSE YOUR PREFERRED ENGINE TYPE AND CAPACITY, TRANSMISSION, CAB AND SEATING CONFIGURATION AND TRAY TYPE. OTHER OUTSTANDING FEATURES OF THE 4WD RANGE INCLUDE MECHANICAL RELIABILITY AND DURABILITY, OVERALL QUALITY AND PERFORMANCE, VALUE FOR MONEY, DRIVING COMFORT AND FUEL EFFICIENCY.





POWER UNDER THE BONNET

The new Triton turbo diesel engine is a 2.8 litre fuel injected intercooled turbocharged unit. It has all the power and torque you need to get the tough jobs done.

2835 cc 8-valve SOHC I/C T/C diesel engine

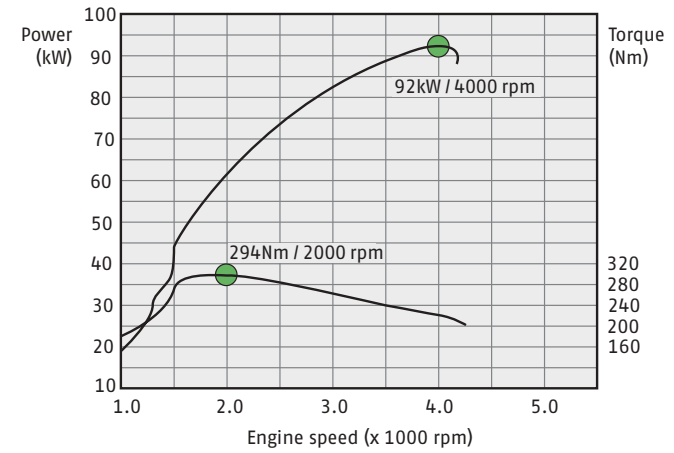

TALK ABOUT TORQUE

The 2.8 litre turbo diesel engine delivers powerful low end torque, excellent fuel efficiency with low emissions, long lasting low maintenance durability and smooth performance. This intercooled turbocharged powerhouse delivers the superior low end torque needed for on road acceleration or demanding off road situations like climbing steep hills.

COMFORT WHERE IT COUNTS

Cloth trim, reclining front sports seats and optional air conditioning in the GLS Double Cab mean maximum driver comfort on the longest runs. Other features include AM/FM radio with in-dash CD 4 speaker audio unit, sports instrumentation pod, power windows, electric mirrors, floor carpet and central locking with remote keyless entry.





CHOOSE YOUR GEAR

5 speed manual transmission is standard on all 4WD models while a 4 speed automatic transmission is optional on the GLS Double Cab petrol.



STORAGE AND SAFETY

The GLX Club Cab features bucket seats with plenty of storage space behind the seats as well as floor carpet, an AM/FM radio cassette with 2 speaker audio system. Safety is also not forgotten with optional driver and passenger SRS airbags on all 4WD models.



THE PETROL OPTION

The Triton 4WD range is also available in a powerful 3.0 litre, V6 petrol engine. The 24 valve multipoint fuel injected engine develops 133kW at 5250 rpm and 255Nm of torque at 4500 rpm. Petrol engines are LPG compatible.

2972 cc 24 valve V6 SOHC ECI-MULTI engine

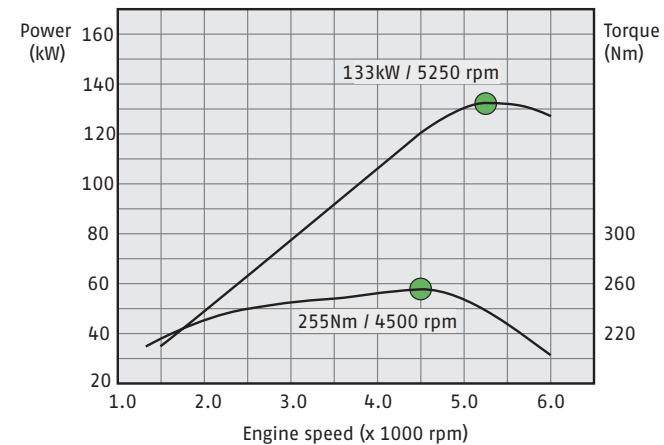

The 3.0 litre V6 petrol engine provides excellent fuel economy and solid all round performance, from leisurely long distance travel to 4WD adventure.



GLS DOUBLE CAB INTERIOR

BEHIND THE TINTED GLASS, INSIDE THE ROOMY GLS DOUBLE CAB, THERE IS AN ADVANCED WORLD OF DRIVER CONVENIENCE AT YOUR FINGERTIPS. THE CABIN SEATS FIVE AND OFFERS CHILDPROOF REAR DOOR LOCKS AND REAR HEADRESTS. THE SPORTS INSTRUMENT POD INCLUDES INCLINOMETER, DIGITAL OUTSIDE TEMPERATURE DISPLAY AND VOLTMETER. THE RECLINING SPORTS BUCKET SEATS ARE TRIMMED IN SPORTS CLOTH. AN AM/FM RADIO WITH IN-DASH CD AND 4 SPEAKER AUDIO SYSTEM, POWER WINDOWS, ELECTRIC MIRRORS, HANDY CUPHOLDERS AND OPTIONAL AIR CONDITIONING AND DUAL AIRBAGS COMPLETE THE PICTURE.



4WD GLX CAB CHASSIS

Count on the GLX Cab Chassis for reliability, available in a 2.8 litre intercooled turbo diesel or a 3.0 litre V6 petrol. 5 speed manual transmission, limited slip differential, power steering and engine immobiliser (petrol only) are standard. The cab has split bench reclining front seats to fit three people, a tinted rear window and an AM/FM radio cassette player. A pickup body option increases versatility.

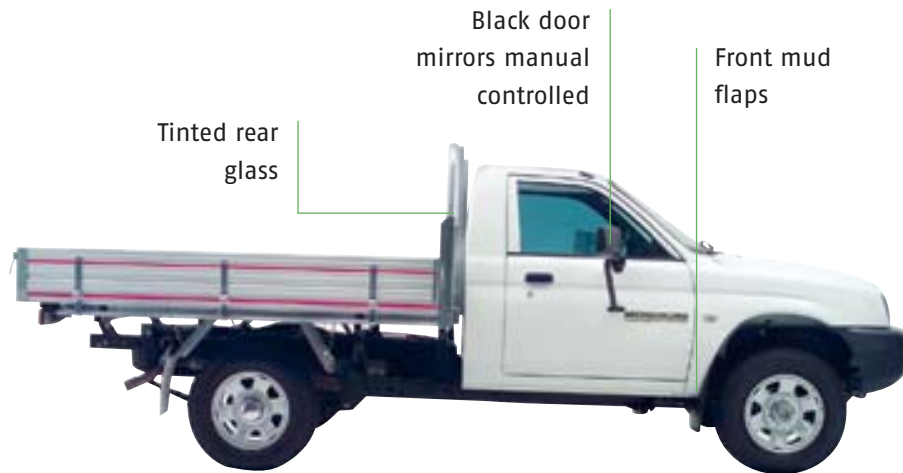

(shown with optional tray)

4WD GLX CLUB CAB

Storage is the key to the GLX Club Cab with a large storage area behind the cloth trimmed, reclining bucket seats and a hidden storage compartment. Other features include analogue instrumentation, fixed intermittent wipers, floor carpet and side door impact beams. Available in a 2.8 litre intercooled turbo diesel or 3.0 litre V6 petrol 5 speed manual, the Club Cab also boasts limited slip differential, power steering and engine immobiliser (petrol only).

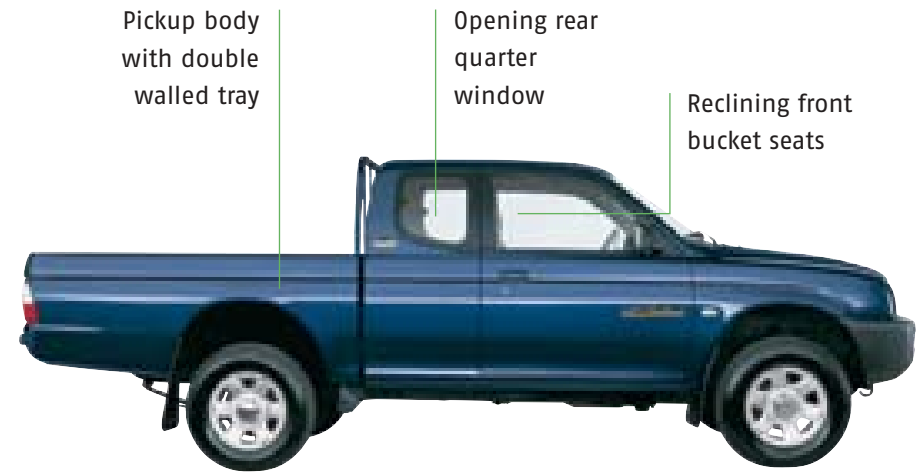

AM/FM Radio cassette with 2 speaker audio unit



16" styled steel wheels



Analogue instrumentation



Hidden storage compartment

4WD GLX DOUBLE CAB

The big, 5 seater GLX Double Cab has space for the whole crew with front bucket seats and rear headrests along with childproof door locks and durable vinyl flooring. The analogue instruments include a tripmeter, speedometer, tachometer, fuel and water temperature gauges. It is available in a 2.8 litre intercooled turbo diesel or 3.0 litre V6 petrol 5 speed manual with power steering and an engine immobiliser (petrol only). A delete pickup body option completes the GLX Double Cab's versatility.



4WD GLS DOUBLE CAB

No detail has been overlooked on the GLS Double Cab. From the two tone paint to electrically controlled chrome door mirrors, 16" alloy wheels and standard fender flares, the GLS is simply not your standard ute. Central locking, remote keyless entry, power steering, engine immobiliser (petrol only) and power windows are standard as are sports seats and floor carpet. The GLS is available in a 2.8 litre intercooled turbo diesel 5 speed manual or a 3.0 litre V6 petrol with either 5 speed manual or 4 speed automatic transmission.



Rear seats make room for 5



AM/FM radio with in dash CD and 2 speaker audio unit



Central locking with remote keyless entry



Sports instrumentation pod

CARRYING STRENGTH

A strong reinforced ladder frame chassis reinforces Triton's tough and dependable heritage. It is perfect for load carrying strength and offers the reassurance of special front inner side members that allow the vehicle's body to deform in a controlled, energy absorbing fashion in event of a frontal collision. This gives increased passive safety with the strength and dependability of a proven workhorse.

DOUBLE WISHBONE FRONT SUSPENSION

2WD

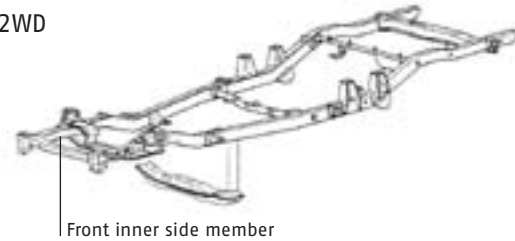

4WD

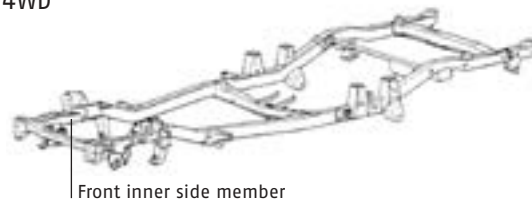

TOUGH STUFF

Triton is made to last with high tensile and galvanised steel panels used throughout the vehicle. More than 60% of Triton is composed of galvanised steel, ensuring that your trusted Triton will be there to serve you for many years to come. Your confidence is assured because every Triton is backed by a 5 year perforation corrosion warranty.

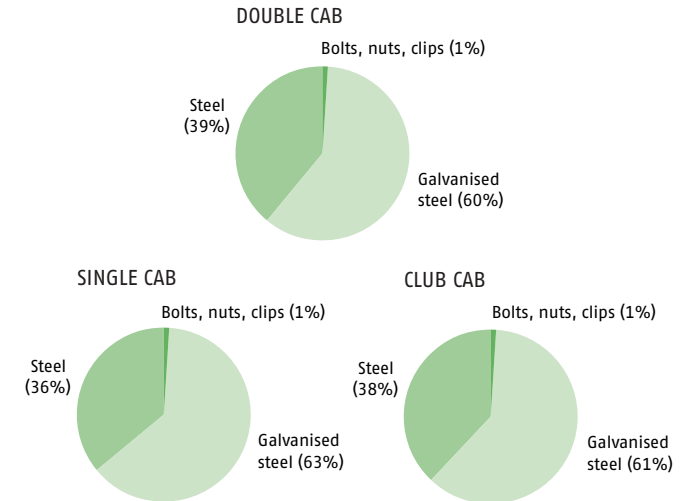

SLIP INTO 4WD INSTANTLY

With 'Easy Select' Part Time 4WD (on GLS), Triton offers you the convenience of switching between 2WD and 4WD without having to leave the vehicle. All you have to do is stop and shift the transfer lever into 4H. This automatically locks the front free wheeling differential. You can then move between 2H and 4H at any speed up to 100kph as long as the ignition remains in the 'on' position. GLX models feature manual locking hubs. Once the lock is engaged, the 'Easy Select' system takes over and you can shift between 2H and 4H on the move up to 100kph.

Transfer position	2H → 4H → 4L → 4H → 2H → 2H						
Ignition key	ON			OFF			
4WD indicator lamp	OFF	ON	ON	ON	OFF	OFF	ON
Free-wheel lock lamp	OFF	ON	WHEEL LOCK	WHEEL LOCK	WHEEL LOCK	OFF	WHEEL LOCK

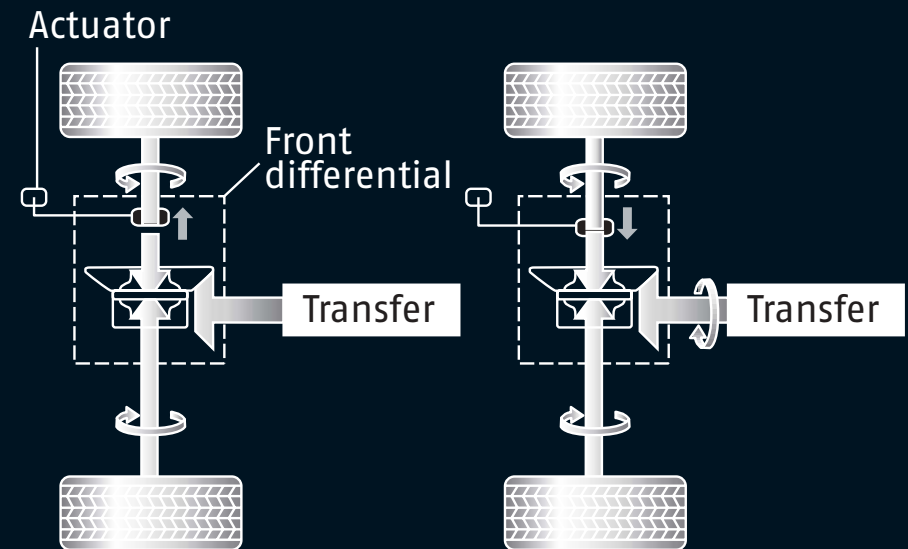

TOUGH OUTBACK

The Triton pickup body features double walled construction, fabricated from single sheet inner and outer panels. Side wall reinforcements provide outstanding cargo holding strength. The double wall design delivers high structural integrity with superior corrosion resistance.

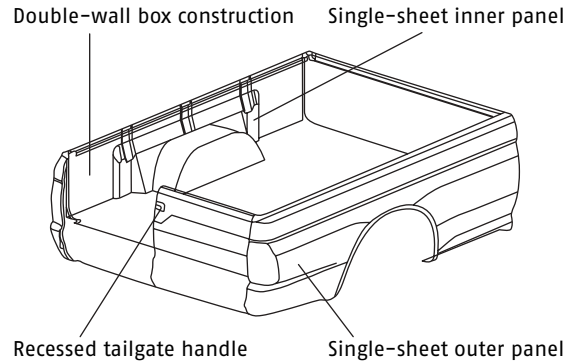

CONFIDENT BRAKING

All Tritons have refined front ventilated discs with outstanding rigidity in the front brake assembly. Triton GLS features the extra performance of dual piston calipers that you would expect from a vehicle that is a high performer. The rear brakes are tried and proven large drums with leading and trailing shoes. On 4WD models, the braking system is fitted with larger discs and drums as well as a more powerful tandem booster to give you more confidence both on and off the road. All models feature a load sensing proportioning valve that regulates rear brake pressure to ensure consistent braking performance regardless of the load you are carrying out back.



THE LONG RUN

Triton's suspension design firmly and flexibly supports the vehicle while delivering sedan like strength that is arguably the best in its field. Triton's stability is assured with a wide front track. Surefooted handling is the result of the proven double wishbone front suspension on 2WD models. On 4WD models the tough torsion bar springs ensure stability with a smooth ride. A long wheel stroke improves ride and handling on rough terrain and 'Alignment Optimisation' ensures handling stability. Triton's rear suspension utilises proven leaf springs and a rigid rear axle to handle the tasks that would be expected of a tough load carrier like Triton.

DOUBLE WISHBONE FRONT SUSPENSION

2WD

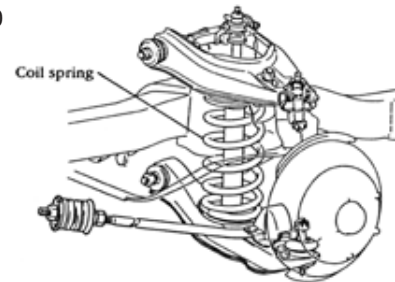

4WD

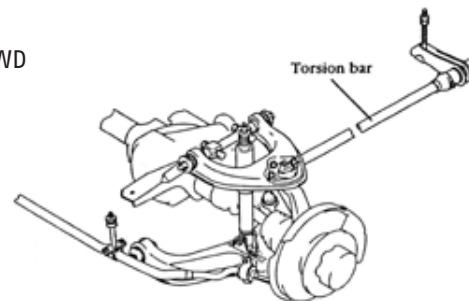

RIGID LEAF REAR SUSPENSION

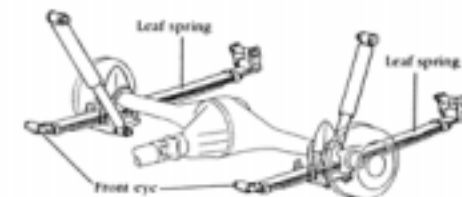
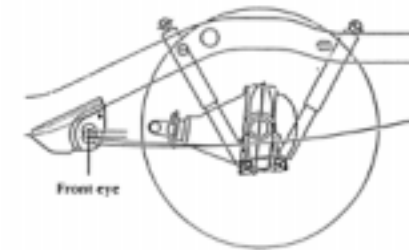



2WD

(SHOWN WITH OPTIONAL TRAY)



CAB CHASSIS

THE POPULAR PETROL POWERED 2WD RANGE IS AVAILABLE IN TWO ENGINE OPTIONS WHICH COMBINE POWER WITH AROUND TOWN VERSATILITY. THE GLX CAB CHASSIS BOASTS A BIG 3.0 LITRE, V6 24 VALVE MULTIPOINT FUEL INJECTED ENGINE DEVELOPING 133KW AT 5250 RPM AND 255NM OF TORQUE AT 4500 RPM. ALL OTHER 2WD MODELS HAVE A 2.4 LITRE, 16 VALVE MULTIPOINT FUEL INJECTED ENGINE WHICH DEVELOPS 97KW AT 5250 RPM AND 192NM OF TORQUE AT 4000 RPM. THE GLX DOUBLE CAB ALSO OFFERS THE CHOICE OF THE BIG 3.0 LITRE V6 WITH EITHER 5 SPEED MANUAL OR 4 SPEED AUTOMATIC. ALL 2WD ENGINES ARE LPG COMPATIBLE.

UNDER THE BONNET

Triton 2WD models offer two high performance petrol engine options. These are a big 3.0 litre, V6, 24 valve multipoint, fuel injected motor that develops 133kW of power at 5250 rpm and 255Nm of torque at 4500 rpm. Or, a 2.4 litre, 16 valve, multipoint fuel injected 4 cylinder that develops 97kW of power at 5250 rpm and 192Nm of torque at 4000 rpm.



2351 cc 16 valve ECI-MULTI

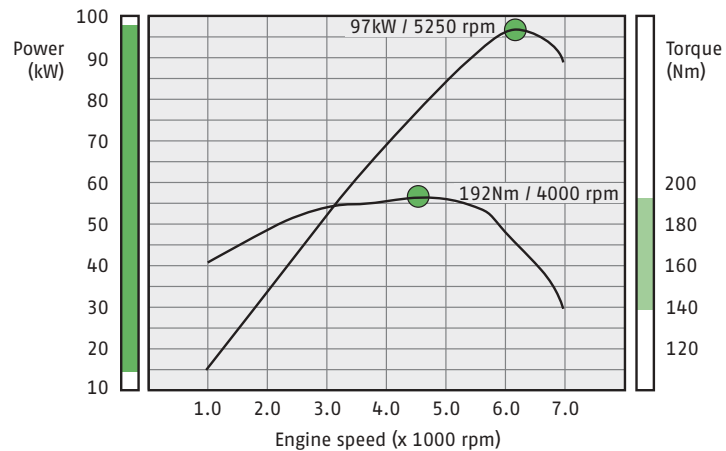

LOOKING AFTER THE BOTTOM LINE

The 2.4 litre 4 cylinder engine develops its maximum torque at a low 4000 rpm, resulting in a blend of inspired performance with outstanding fuel economy.

2972 cc 24 valve V6 SOHC ECI-MULTI engine

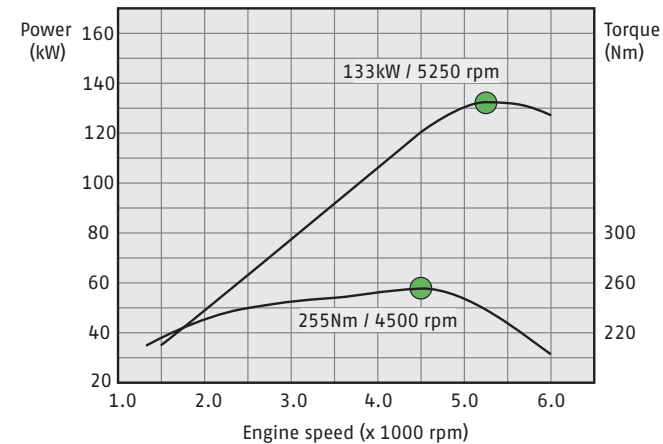

THE V6 TORQUE

The 3.0 litre V6 petrol engine delivers excellent low to mid range torque needed for the stop and go of urban traffic and the power to easily deal with your payload needs.



ON THE SEAT

All models feature cloth trim seats for maximum driver comfort. The GLX 2WD Club Cab boasts reclining front bucket seats and a hidden storage area while the Cab Chassis models have a reclining split bench seat for three passengers. The big, 5 seater Double Cab includes front reclining bucket seats and rear seat headrests.



CARRYING THE LOAD

One tonne payload capacity pickup body features special double wall construction, fabricated from corrosion resistant single sheet inner and outer panels.



TAILOR MADE

Choose from the extensive accessories to tailor make your ute to suit your needs. Accessories available include tow bars, roll bars, alloy wheels, side steps, fender flares, tonneau covers, nudge bars and front protection bars.

2WD GL CAB CHASSIS

The 2WD GL Cab Chassis has a 2.4 litre 4 cylinder petrol 5 speed manual engine with power steering and engine immobiliser. It is fitted with 14" styled steel wheels and inside the cab there is an AM/FM radio cassette player standard.

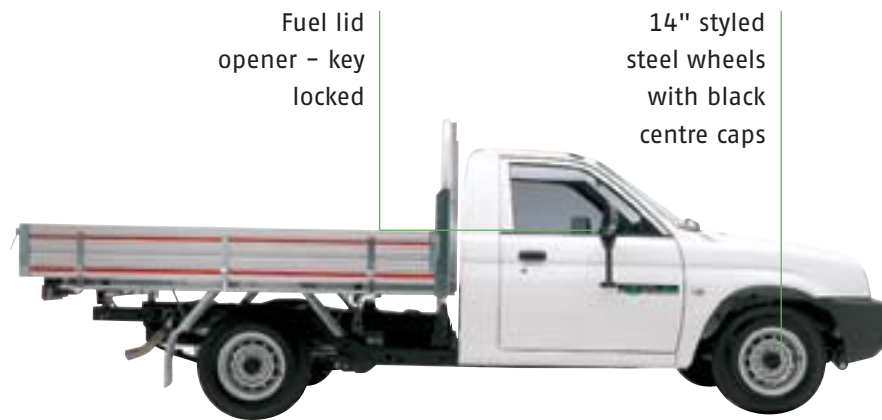

(Shown with optional tray)

2WD GLX CAB CHASSIS

The 2WD GLX Cab Chassis offers power and choice, with a 3.0 litre V6 petrol engine and the option of 5 speed manual or 4 speed automatic transmission. Protect yourself with dual SRS airbags available as an option.



(Shown with optional tray)



Split bench front seat with recline function



2.4 litre petrol. 5 speed manual



16" styled steel (V6 only)



Ergonomical dashboard

2WD GLX CLUB CAB

Inside the cab is where you see the difference with additional storage space behind the cloth trimmed reclining bucket seats, along with the hidden storage compartment. The GLX Club Cab has a 2.4 litre 4 cylinder petrol engine with 5 speed manual transmission.

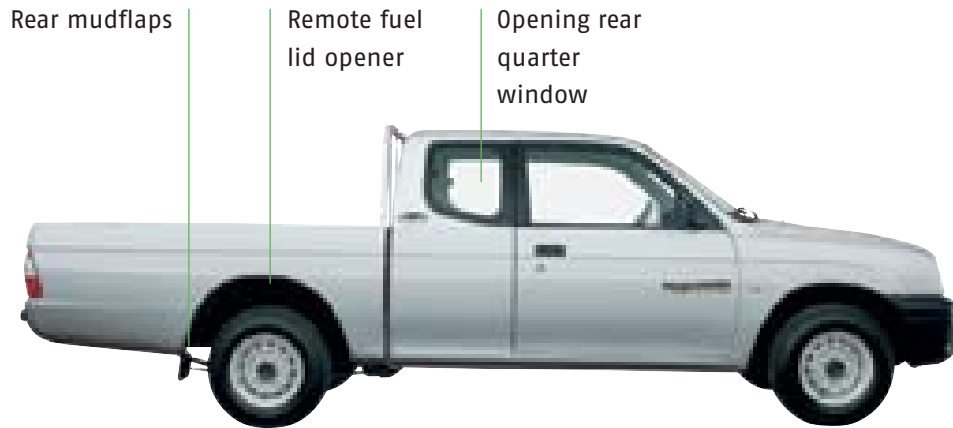

2WD GLX DOUBLE CAB

Flexibility is the key to the GLX Double Cab, with a choice of a 2.4 litre 4 cylinder petrol 5 speed manual engine or a 3.0 litre V6 engine with 5 speed manual or 4 speed automatic transmission. Other features include reclining bucket seats, low fuel warning lamp, durable vinyl flooring, rear seat headrests and childproof rear door locks. For added safety dual SRS airbags are available as an option on V6 models.

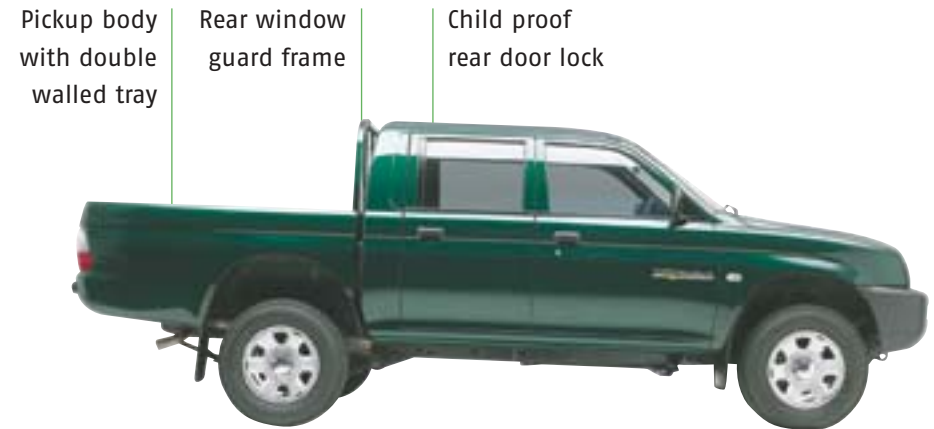

AM/FM radio cassette player

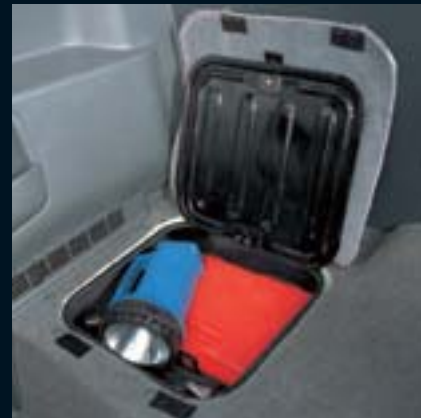

Hidden storage compartment



AM/FM radio with in dash CD and 2 speaker audio unit



Extra room with rear seating for 3

TRITON COLOUR RANGE

GL/GLX MODELS



Marble White



Pyrenees Black

GLX MODELS ONLY



Chromatic Silver



Palma Red



Timber Green



Nares Blue

GLS MODELS ONLY



Pyrenees Black / Chromatic Silver



Bordeaux Maroon / Chromatic Silver



Timber Green / Chromatic Silver



Nares Blue / Chromatic Silver

TRITON SPECIFICATIONS

ENGINE	2.4L 4 CYL., SOHC, 16 VALVE PETROL WITH 'BALANCE SHAFT'	2.8L 4 CYL., SOHC DIESEL WITH INTERCOOLED TURBOCHARGER	3.0L V6, SOHC 24 VALVE PETROL
Bore x stroke	86.5mm x 100mm	95mm x 100mm	91.1mm x 76mm
Capacity	2351cm ³	2835cm ³	2972cm ³
Compression ratio	9.5:1	21.0:1	9.0:1
Fuel system	ECl multi fuel inject	Fuel injection	ECl multi fuel inject
Maximum power (DIN)	97kW @ 5250 rpm	92kW @ 4000 rpm	133kW @ 5250 rpm
Maximum torque (DIN)	192Nm @ 4000 rpm	294Nm @ 2000 rpm	255Nm @ 4500 rpm
ELECTRICAL SYSTEM			
Battery	12V-36 AH	12V-64 AH	12V-52 AH
Alternator	12V-55A	12V-90A	12V-85A
CLUTCH			
Manual	Single dry plate with diaphragm spring		
Automatic	3 element torque converter with lock-up		
DRIVE TRANSFER SYSTEM (4WD MODELS ONLY)			
Type	"Easy Select" part time 4WD		
	Auto front free-wheel differential on GLS		
BRAKES			
Front	Ventilated discs, single piston calipers (GLS: twin-piston calipers)		
Rear	Drums, leading and trailing shoes with load sensing proportioning valve		
SUSPENSION			
Front (4 cylinder)	Independent - wishbone, coil springs		
Front (V6 and diesel)	Independent - wishbone, torsion bar		
Rear	Rigid - elliptic leaf spring		
STEERING			
Power assisted recirculating ball and nut			
WHEELS			
Type	GL/GLX 2.4L 4 CYL.	GLX 3.0L V6 AND 2.8L TURBO DIESEL	GLS
	Pressed steel - 14" x 6"	Pressed steel - 16" x 6"	Alloy 16" x 7"
TYRES			
Size	14" 185R14C-8PR	16" 205/80R16-104S	16" 265/70R16-112S

TRITON SPECIFICATIONS

4WD TRANSMISSION

RATIOS	V6 MANUAL	V6 AUTO	TURBO DIESEL MANUAL
First	3.918	2.842	3.952
Second	2.261	1.495	2.238
Third	1.395	1.000	1.398
Fourth	1.000	0.731	1.000
Fifth	0.829	-	0.760
Reverse	3.952	2.720	3.553
TRANSFER RATIO			
High	1.000	1.000	1.000
Low	1.925	1.925	1.900
FINAL DRIVE			
Final gear ratio	4.900	4.900	4.900

2WD TRANSMISSION

RATIOS	4 CYL. MANUAL	V6 MANUAL	V6 AUTO
First	3.967	3.952	2.842
Second	2.136	2.238	1.495
Third	1.360	1.398	1.000
Fourth	1.000	1.000	0.731
Fifth	0.856	0.819	-
Reverse	3.578	3.553	2.720
FINAL DRIVE			
Final gear ratio	4.222	4.900	4.900

4WD SPECIFICATIONS

	CAB CHASSIS GLX 5 SPEED MANUAL V6	CAB CHASSIS GLX 5 SPEED MANUAL TURBO DIESEL	CLUB CAB GLX 5 SPEED MANUAL V6	CLUB CAB GLX 5 SPEED MANUAL TURBO DIESEL	DOUBLE CAB GLX 5 SPEED MANUAL V6	DOUBLE CAB GLX 5 SPEED MANUAL TURBO DIESEL	DOUBLE CAB GLS 5 SPEED MANUAL V6	DOUBLE CAB GLS 4 SPEED AUTO V6	DOUBLE CAB GLS 5 SPEED MANUAL TURBO DIESEL
DIMENSIONS (MM)									
Overall height	1745	1745	1775	1775	1780	1780	1800	1800	1800
Overall length – with pickup body fitted	4995	4995	5110	5110	4995	4995	4995	4995	4995
Overall width	1695	1695	1695	1695	1695	1695	1775	1775	1775
Ground clearance	215	215	215	215	215	215	235	235	235
Track – front	1420	1420	1420	1420	1420	1420	1465	1465	1465
Track – rear	1435	1435	1435	1435	1435	1435	1480	1480	1480
Pickup body – between arches (where fitted)	1035	1035	1035	1035	1035	1035	1035	1035	1035
Pickup body – floor height (where fitted)	860	860	875	875	860	860	880	880	880
Pickup body – height (where fitted)	400	400	400	400	400	400	400	400	400
Pickup body – length (where fitted)	2245	2245	1830	1830	1500	1500	1500	1500	1500
Pickup body – width (where fitted)	1470	1470	1470	1470	1470	1470	1470	1470	1470
Wheelbase	2960	2960	2960	2960	2960	2960	2960	2960	2960
CAPACITIES									
Gross vehicle mass (kg)	2810	2830	2740	2830	2810	2830	2705	2715	2830
Kerb mass (kg)	1595	1685	1655	1745	1690	1780	1705	1710	1795
Payload (kg)*	1215	1145	1085	1085	1120	1050	1000	1005	1035
Maximum front axle load (kg)	1200	1200	1200	1200	1200	1200	1200	1200	1200
Maximum rear axle load (kg)	1800	1800	1800	1800	1800	1800	1650	1650	1650
Seating capacity	3	3	2	2	5	5	5	5	5
MAXIMUM TOWING CAPACITY**									
Kg – with trailer brakes	1500	2200	1500	2200	1500	2200	1500	2200	2200
Kg – without trailer brakes	500	500	500	500	500	500	500	500	500
TURNING CIRCLE									
Metres (kerb to kerb)	12.8	12.8	12.8	12.8	12.8	12.8	12.8	12.8	12.8
FUEL TANK CAPACITY									
Litres	75	75	75	75	75	75	75	75	75

* PAYLOAD INCLUDES OCCUPANTS, FUEL AND FITTED OPTIONS (IF ANY). THE WEIGHT OF THESE MUST BE DEDUCTED FROM PAYLOAD TO DETERMINE ACTUAL LOAD CARRYING CAPACITY. FRONT AND/OR REAR AXLE LOADS MUST NOT BE EXCEEDED.

** SUBJECT TO STATE REGULATIONS AND TOWBAR DESIGN

4WD SPECIFICATIONS

MECHANICAL	CAB CHASSIS GLX	CLUB CAB GLX	DOUBLE CAB GLX	DOUBLE CAB GLS
3.0 litre V6 petrol 24 valve	•	•	•	•
2.8 litre intercooled turbo diesel	◦	◦	◦	◦
5 speed manual transmission	•	•	•	•
4 speed auto transmission (petrol only)	–	–	–	◦
Engine immobiliser (petrol only)	•	•	•	•
Manual free wheeling hubs	•	•	•	–
Auto free wheeling hubs	–	–	–	•
Limited slip differential (rear)	•	•	•	•
Power steering	•	•	•	•
Hand throttle (diesel only)	•	•	•	•
EXTERIOR				
Pickup body with double walled tray	◦	•	•	•
Rear window guard frame (when pickup body fitted)	•	•	•	–
Black door mirrors – manually controlled	•	•	•	–
Chrome door mirrors – electrically controlled	–	–	–	•
Wheels – 16" styled steel	•	•	•	–
Wheels – 16" alloy	–	–	–	•
Mudflaps (front)	•	•	•	•
Mudflaps (rear) (when pickup body fitted)	•	•	•	•
Two tone paint	–	–	–	•
Fender flares	–	◆	◆	•
Side steps	◆	◆	◆	◆
Bullbar	◆	◆	◆	◆
Driving lights	◆	◆	◆	◆
Opening rear quarter window	–	•	–	–
Tinted rear glass	•	•	•	•
Heated rear window	–	–	–	•
Fuel lid opener – key locked	•	–	•	–
Fuel lid opener – remote	–	•	–	•
Engine under cover	•	•	•	•
Front skid plate	•	•	•	•
Transfer case protection	•	•	•	•

• standard ◦ optional – not available ◆ available as part of an option pack only ◆ dealer fitted accessory

4WD SPECIFICATIONS

INTERIOR	CAB CHASSIS GLX	CLUB CAB GLX	DOUBLE CAB GLX	DOUBLE CAB GLS
Floor covering – vinyl	•	–	•	–
Floor covering – carpet	–	•	–	•
Fabric door trim insert	•	•	•	•
Air conditioner	◆	◆	◆	◆
Central locking with remote keyless entry	–	–	–	•
Power windows – front and rear	–	–	–	•
Front wipers with 2 speeds and fixed intermittent	•	•	•	–
Front wipers with 2 speeds and variable intermittent	–	–	–	•
Steering column – tilt adjustable	•	•	•	•
Analogue instrumentation includes – speedometer with tripmeter; tachometer, fuel and water temperature gauges	•	•	•	•
Sports instrumentation pod includes – inclinometer, outside temperature, voltmeter	–	–	–	•
Warning lamps include – 4WD indicator, auto trans position (auto only), door ajar, low fuel, water separator (diesel only)	•	•	•	•
Headlamps “ON” audible warning buzzer	•	•	•	•
Ignition key in lock – audible warning	–	–	–	•
Instrument lamp variable dimming control	•	•	•	•
Cupholders – 2	•	•	•	•
Passenger side vanity mirror	–	–	–	•
Map reading lamps	–	–	–	•
Digital clock	•	•	•	•
Lockable glove compartment	•	•	•	•
Centre console storage box	–	•	•	•
Centre console armrest	–	–	–	•
In-dash storage box	•	•	•	•
Rear seat centre armrest	–	–	–	•
Storage box behind rear seat centre armrest	–	–	–	•
Hidden storage compartment	–	•	–	–
Door storage pockets	•	•	•	•
Load restraint strap	–	•	–	–
Overhead assist grip handles	•1	•1	•3	•3
Passenger side grab handle	–	–	–	•

4WD SPECIFICATIONS

SEATING	CAB CHASSIS GLX	CLUB CAB GLX	DOUBLE CAB GLX	DOUBLE CAB GLS
Front seat split bench with recline function	•	–	–	–
Front seat buckets with recline function	–	•	•	•
Front sports seats	–	–	–	•
Rear seat headrests x 2	–	–	•	•
Seat trim – cloth	•	•	•	–
Seat trim – sports cloth	–	–	–	•
AUDIO SYSTEMS				
AM/FM radio cassette – 2 speakers	•	•	–	–
AM/FM radio CD – 2 speakers	–	–	•	–
AM/FM radio CD – 4 speakers	–	–	–	•
SAFETY				
Driver and passenger SRS airbags	◦	◦	◦	◊
Side door impact beams	•	•	•	•
Child proof rear door locks	–	–	•	•
Child restraint anchorage	•1	•1	•2	•2
OPTIONS				
Delete pickup body with double walled tray	–	◦	◦	–
Leather covered steering wheel	–	–	–	◊
Leather covered gear shift and 4WD transfer-shift levers (manual only)	–	–	–	◊
Chrome exterior door handles and tailgate handle	–	–	–	◊
Chrome interior door handles	–	–	–	◊
Chrome grille surround	–	–	–	◊

• standard ◦ optional – not available ◊ available as part of an option pack only ◆ dealer fitted accessory

2WD SPECIFICATIONS

	CAB CHASSIS GL 5 SPEED MANUAL 4 CYL.	CAB CHASSIS GLX 5 SPEED MANUAL V6	CAB CHASSIS GLX 4 SPEED AUTO V6	CLUB CAB GLX 5 SPEED MANUAL 4 CYL.	DOUBLE CAB GLX 5 SPEED MANUAL 4 CYL.	DOUBLE CAB GLX 5 SPEED MANUAL V6	DOUBLE CAB GLX 4 SPEED AUTO V6
DIMENSIONS (MM)							
Overall height	1585	1755	1755	1605	1610	1780	1780
Overall length - where pickup body fitted	4770	4995	4995	5110	4995	4995	4995
Overall width	1695	1695	1695	1695	1695	1695	1695
Ground clearance	190	215	215	190	190	215	215
Track - front	1450	1420	1420	1450	1450	1420	1420
Track - rear	1435	1435	1435	1435	1435	1435	1435
Pickup body - between arches (where fitted)	-	1035	1035	1035	1035	1035	1035
Pickup body - floor height (where fitted)	-	880	880	695	680	880	880
Pickup body - height (where fitted)	-	400	400	400	400	400	400
Pickup body - length (where fitted)	-	2245	2245	1830	1500	1500	1500
Pickup body - width (where fitted)	-	1470	1470	1470	1470	1470	1470
Wheelbase	2960	2960	2960	2960	2960	2960	2960
CAPACITIES							
Gross vehicle mass (kg)	2530	2810	2810	2440	2510	2770	2770
Kerb mass (kg)	1310	1560	1535	1380	1415	1630	1625
Payload (kg)*	1220	1250	1275	1060	1095	1140	1145
Maximum front axle load (kg)	1000	1200	1200	1000	1000	1200	1200
Maximum rear axle load (kg)	1700	1800	1800	1700	1700	1800	1800
Seating capacity	3	3	3	2	5	5	5
MAXIMUM TOWING CAPACITY**							
Kg - with trailer brakes	1500	1500	1800	1500	1500	1500	1800
Kg - without trailer brakes	500	500	500	500	500	500	500
TURNING CIRCLE							
Metres (kerb to kerb)	11.6	12.8	12.8	11.6	11.6	12.8	12.8
FUEL TANK CAPACITY							
Litres	69	75	75	69	69	75	75

* PAYLOAD INCLUDES OCCUPANTS, FUEL AND FITTED OPTIONS (IF ANY). THE WEIGHT OF THESE MUST BE DEDUCTED FROM PAYLOAD TO DETERMINE ACTUAL LOAD CARRYING CAPACITY. FRONT AND/OR REAR AXLE LOADS MUST NOT BE EXCEEDED.

** SUBJECT TO STATE REGULATIONS AND TOWBAR DESIGN

2WD SPECIFICATIONS

	CAB CHASSIS GL	CAB CHASSIS GLX	CLUB CAB GLX	DOUBLE CAB GLX
MECHANICAL				
2.4 litre petrol 16 valve	•	–	•	•
3.0 litre V6 petrol	–	•	–	◦
5 speed manual transmission	•	•	•	•
4 speed automatic transmission (V6 only)	–	◦	–	◦
Engine immobiliser	•	•	•	•
Power steering	•	•	•	•
EXTERIOR				
Pickup body with double walled tray	–	◦	•	•
Delete pickup body with double walled tray	•	•	–	–
Rear window guard frame (when pickup body fitted)	–	•	•	•
Black door mirrors – manually controlled	•	•	•	•
Wheels – 14" styled steel with black centre caps	•	–	•	•
Wheels – 16" styled steel (V6 only)	–	•	–	◦
Wheels – 16" alloy (Strada)	–	◆	◆	◆
Mudflaps (front)	–	•	•	•
Mudflaps (rear) (when pickup body fitted)	◆	•	•	•
Fender flares	–	–	◆	◆
Bullbar	◆	◆	◆	◆
Driving lights	◆	◆	◆	◆
Opening rear quarter window	–	–	•	–
Fuel lid opener – key locked	–	•	–	•
Fuel lid opener – remote	–	–	•	–
INTERIOR				
Floor covering – vinyl	•	•	–	•
Floor covering – carpet	–	–	•	–
Fabric door trim insert	–	•	•	•
Air conditioner	◆	◆	◆	◆
Front wipers with 2 speeds and fixed intermittent	•	•	•	•
Steering column – tilt adjustable	•	•	•	•
Analogue instrumentation includes – speedometer with tripmeter; tachometer, fuel and water temperature gauges	•	•	•	•
Warning lamps include – auto transmission position (auto only); door ajar; low fuel	•	•	•	•
Headlamps "ON" audible warning buzzer	•	•	•	•
Instrument lamp variable dimming control	•	•	•	•
Cupholders – 2	•	•	•	•

• standard ◦ optional – not available ◆ available as part of an option pack only ♦ dealer fitted accessory

2WD SPECIFICATIONS

	CAB CHASSIS GL	CAB CHASSIS GLX	CLUB CAB GLX	DOUBLE CAB GLX
INTERIOR CONTINUED				
Digital clock	•	•	•	•
Lockable glove compartment	•	•	•	•
Centre console storage box	–	–	•	•
In-dash storage box	•	•	•	•
Door storage pockets	•	•	•	•
Hidden storage compartment	–	–	•	–
Load restraint strap	–	–	•	–
Overhead assist grip handles	•1	•1	•1	•3
SEATING				
Front seat split bench with recline function	•	•	–	–
Front seat buckets with recline function	–	–	•	•
Rear seat headrests x 2	–	–	–	•
Seat trim – cloth	•	•	•	•
SAFETY				
Driver and passenger SRS airbags (V6 only)	–	○	–	○
Side door impact beams	•	•	•	•
Child proof rear door locks	–	–	–	•
Child restraint anchorage	•1	•1	•1	•2
AUDIO SYSTEMS				
AM/FM radio cassette – 2 speakers	•	•	•	–
AM/FM radio CD – 2 speakers	–	–	–	•

GENUINE ACCESSORIES

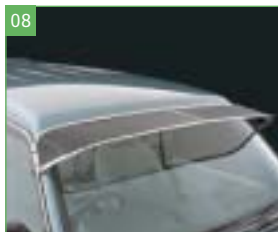

GENUINE ACCESSORIES
Genuine Mitsubishi accessories add value and flair to your new Triton. They are styled to perfectly complement Triton's lines and like Triton, they're tough enough to withstand anything nature can dish out. All Genuine Mitsubishi accessories are covered by Mitsubishi's New Car Warranty when fitted at point of sale of the new vehicle. A 12 month/20,000km warranty applies to accessories when fitted later.

01 AIR CONDITIONING
Mitsubishi's recirculating air conditioning system delivers clean filtered air allowing you to enjoy a comfortable environment all year round. Mitsubishi use only environmentally friendly R134A refrigerant.

02 ALLOY NUDGE BAR
Manufactured from highly polished alloy, it prevents minor damage from occurring to the body work whilst maintaining the original appearance of the front bumper bar. Not suitable for vehicles fitted with SRS airbags.

03 ALLOY WHEELS – STRADA
Add style and personality to your Triton with these 6.00JJ x 16" alloy wheels. Package includes four wheels, nuts, centres and retaining rings. Available for Triton GLX only.

04 BONNET PROTECTOR
Deflect flying stones and prevent chipping of the bonnet paintwork.

05 HEADLAMP GUARDS
Prevent damage to lights caused by flying stones. These clip on guards are easily removed for cleaning.

06 FENDER FLARE PACKAGE
Available for Club Cab and Double Cab GLX models, they protect the body paintwork from stone damage. Easy to install they are manufactured from durable UV protected material.

07 FRONT PROTECTION BAR – ALLOY
Available in bright alloy they are designed to provide protection in the event of a low speed front impact. Not airbag compatible. Also available in high grade steel for GL and GLX models.

08 MESH SUNSHADE
Manufactured from extruded aluminium, and painted black to reduce glare.

09 MUD FLAPS
Manufactured from high quality, durable rubber.

10 ROLL BAR
Available in polished alloy, they add style and offer additional roll crush protection in the unfortunate event of a rollover. Only available on 4 x 4 and 4 x 2 V6 Double Cab.

11 SIDE STEPS
Greatly assist in entering and leaving your Triton, whilst also protecting the panels from stone damage. Constructed from heavy-duty aluminium they provide the perfect finishing touch to all Triton models.

12 TONNEAU COVER
Provide all weather protection and privacy to the cargo area. Manufactured from hi-grade materials to withstand the rigours of the harsh Australian climate.

13 TOWBAR
Engineered to suit your Triton with a choice of towing capacity of either 1500kg or 2200kg. For detailed towing instructions, please contact your local dealer.

14 TRAY BED LINER – DOUBLE CAB
Manufactured from hard-wearing black corrugated plastic, this tray bed liner offers full tray coverage and tailgate and a 'no-drill' fitment.

15 WEATHERSHIELDS
Available for both driver and passenger side windows, prevents wind, rain and run-off water from entering the cabin when driving with a partly open window. A Slimline Weathershield is also available.

16 WEST COAST MIRRORS
Mounting on the driver and passenger doors, enabling greater rear view vision.

17 TRAY BODY
Full range of trays available in General Purpose Aluminium, Heavy Duty Aluminium and Galvanised Steel. Consult your local Mitsubishi Dealer.

18 DRIVING LIGHTS – COMET 550 (DIAMOND SPECTRUM)
Designed to be installed onto either the Bull Bar or Nudge Bar, the Comet 550 series include a pair of 100W lamps complete with protective covers brandishing the Mitsubishi three diamond logo.

19 DRIVING LIGHT – RALLYE 1000 (DIAMOND SPECTRUM)
Designed to be installed onto either the Bull Bar or Nudge Bar, the Rallye 1000 series are available as individual lights for both 100W Pencil Beam and 100W Spread Beam. The lights come complete with a protective cover brandishing the Mitsubishi three diamond logo.

20 CARPET MATS
Made from superior quality materials, features a retaining eyelet on the driver's mat to prevent it slipping under the pedals.

MITSUBISHI RANGE



VERADA

The flagship of the range, this sophisticated sedan or wagon is built in Australia and boasts luxury inclusions. Features a smooth, quiet ride; superior space; state of the art safety and a power enhanced 3.5 litre V6 24 valve fuel injected engine. Verada is also available in All Wheel Drive.



MAGNA

The Australian built 3.5 litre V6 Magna is a powerful, versatile sedan available in two variants Executive and Advance. Both models incorporate the latest technology, luxury and safety. Magna All Wheel Drive boasts Mitsubishi's QuadTec™ system for superior roadholding and traction, resulting in outstanding stability, grip and cornering control for safer driving.



MAGNA VRX & SPORTS

For a more street smart look, Magna VRX & Sports sedan both feature aerodynamic body kits, a finely tuned high performance engine and a range of exclusive sports style features. Sporty styling is carried through to the inside with racing style monogrammed upholstery and white sports instrument dials.



LANCER

With a proud rally heritage, Lancer sedan boasts a range of impressive features, including INVECS II 'Smart Logic' 4 speed automatic transmission. The VRX also features 4 speed 'SPORTS MODE' sequential gear shifting. Lancer sedan is powered by a 2.0 litre SOHC 16 valve multipoint fuel injected engine. The wagon features a 1.8 litre SOHC 16 valve engine.



MIRAGE

Compact, 3 door hatch featuring a zippy 1.5 litre 12 valve, multipoint fuel injected engine. Available as a 5 speed manual or with INVECS II 'Smart Logic' 4 speed automatic transmission. Features include SRS driver's airbag, power steering, ample room and plenty of style.



PAJERO

The leader in its class, Pajero delivers a powerful performance, renowned reliability, generous interior space and superior safety. Powered by a 3.5 litre V6 24 valve fuel injected engine, with the option of a 3.2 litre intercooled turbo direct injection diesel (Di-D).



CHALLENGER

A luxurious and sporty all terrain 4WD with advanced aerodynamic styling and superior ride comfort. Features a 3.0 litre V6, LPG compatible 24 valve multipoint fuel injected engine with an impressive maximum towing capacity of 2270kg.



NIMBUS

A stylish, award winning people mover. Nimbus comfortably seats seven adults with a variety of different seating and storage configurations. Powered by a 2.4 litre SOHC 16 valve, electronic multipoint fuel injected engine.



OUTLANDER

A compact, all wheel drive offering a unique combination of sports styling, flexible interior space, ride comfort and unprecedented safety. Seats five people in comfort and features a range of cargo carrying options, while the automatic transmission boasts 'SPORTS MODE' sequential gear shifting.



EXPRESS

One of Australia's favourite light commercial vans, Express features petrol, LPG compatible and diesel engines in a choice of capacities. The range of body types includes Short Wheel Base (SWB), Medium Wheel Base (MWB), Window Van and Walk Thru model.

Diamond Finance

Take the burden out of financing your new Mitsubishi vehicle with our competitive, reassuring and completely flexible range of finance products developed by Mitsubishi Motors Australia Ltd and St.George Motor Finance Limited.

Diamond Leasing

Our tailored fleet leasing services offer innovative, highly competitive features such as card purchasing, roadside assistance, specialist maintenance services, accident and claims management, optional insurance and more.

Diamond Road Side Assist

Peace of mind is guaranteed anywhere in Australia, 24 hours a day, 365 days a year with our fast, comprehensive, flexible roadside service offering assistance, repairs, towing and storage. Our Premium Roadside Assist clients also enjoy the added benefits of accommodation, medical and transport facilities.

Diamond Insurance

With the sound backing of Swann Insurance and Mitsubishi Motors Australia Ltd, Mitsubishi owners can choose between vehicle and personal protection solutions including motor vehicle, gapcover and loan protection insurance as well as a range of tailored warranty policies.

For more information on Diamond Products and Services contact your Mitsubishi Dealer.

Mitsubishi Motors Australia Ltd. offers a 3 year/ 100,000 kilometre New Vehicle Warranty and a 5 year Perforation Corrosion Warranty on Mitsubishi Triton. Always consult your authorised Mitsubishi Dealer for the latest details on specifications, options, prices, availability and conditions on New Vehicle Warranty. All product illustrations and specifications referred to herein are correct at the time of publication approval. Subject to any applicable Federal, State or Territory laws or ordinances which may apply from time to time. Mitsubishi Motors Australia Ltd. reserves the right, without notice or obligation, to discontinue or make changes to designs, specifications, colours and materials of the options and products referred to herein at any time without incurring any liability to any purchaser thereof. ©Mitsubishi Motors Australia Limited ABN 95 007 870 395 APR 03 MMAL1326



