

Tucson



Drive your way

Your way is our way.

Whatever your dreams. Wherever you're going. Whoever you want to be. The discoveries, the adventures, the challenges await. It's your journey and we'll take you there.

Hyundai. Drive your way.

It's your turn behind the wheel. Live your life and shape your future as you see fit. Our promise is to deliver first-class value through innovative technology, advanced safety features and a determination to build the highest quality cars. Our guarantee to you is your satisfaction with cars that perfectly fit your needs and lifestyle. An extensive dealer network and full warranty support means your confidence in your Hyundai need never be compromised.



City Elite model shown
in Warm Silver



SX V6 AWD model shown
in Warm Silver

Energy and good looks – the Tucson range offers you the freedom to go where you want, how you want. Choose the Tucson City's poise and economical driving for city life or the Tucson V6 AWD's power to go hard in the hills. Your choice, your Tucson.



In recognition of quality

The key to life in the city...

Tucson was named NRMA Motoring & Services' 'Most Affordable SUV to own and run' (Tucson City) 2007.

This practical SUV was also awarded a trophy for the highest ranked compact multi-activity vehicle (MAV) in the 2006 Initial Quality StudySM (IQS) by US consumer researcher J.D. Power and Associates.

Designed to impress

The Tucson range has been engineered with a focus on delivering true driving freedom. Tucson offers full comfort and performance balanced with an eye for economy. Attention to the smallest of details has resulted in a choice of vehicles as relaxed and unwavering on the highway as they are at home in the city. The Tucson V6 AWD is tough when the going gets rough, while the Tucson City makes driving a breeze through the city streets and on the open road. Designed for ever-changing lifestyles, there's a Tucson to suit you.







City Elite interior shown



Looking good

Designed for ever-changing lifestyles, there's a Tucson to suit you. Whether it's the adventurous V6 AWD or the sexy City, Tucson has an exciting look and feel distinctly its own. The detailed interiors are dressed in high quality fabrics and trims (including leather wrapped steering wheel and gear knob) that make every trip supremely comfortable.

There are additional features to further enhance your driving experience such as:

- Polished 5-spoke 16" alloy wheels (V6 AWD)
- Dual 5-Spoke 16" alloy wheels (City)
- Air conditioning with pollen filter
- Sturdy Roof Rails
- Auto Dusk Sensing Headlights – automatically switch on/off according to ambient light level
- Trip computer measuring average fuel consumption, distance to empty, average speed and time taken.

Listen to your music, your way...

Tucson's Bluetooth® enabled audio system allows you to play your favourite MP3 music through the convenience of a USB port. You can even connect your phone wirelessly and use the unit as a hands free device through the system's speakers.



* Only suitable for Bluetooth® compatible phones. The Bluetooth® word mark and logos are owned by Bluetooth SIG, Inc. and used by Hyundai under license.

V6: Goes the distance

The V6 AWD combines exhilarating performance and superior safety with stylish individuality. Compact and manoeuvrable around town, tough and determined off-road – with features that complement the adventurous driver. Body-coloured cladding enhances the muscular appearance, while twin chrome oval tailpipes and 5-spoke 16 inch alloy wheels add a dynamic sporty dimension. Whichever way you look at it, once you're behind the wheel, the visible promise of performance is fulfilled by a 2.7L V6 quad cam engine and All Wheel Drive.

This is the power you need... in a vehicle you'll want to show off.

City: Extra sensory perfection

We've designed the Tucson City to accommodate for your ever-changing lifestyle. The Tucson City easily transforms the powerful good looks of a SUV into a lively city car. The spacious interior has been designed for the fashion-conscious and includes contoured seating, a leather wrapped steering wheel rim and transmission gear knob adding a tactile dimension to the journey. While the Bluetooth® MP3/WMA/CD player with AM/FM tuner keeps you entertained wherever you're headed. The City Elite also features leather seats and an electric tilt or slide glass sunroof to let the fresh outside air in.





Overseas model shown



Tucson City shown with optional Hyundai Genuine Accessories*

Room to move

Tucson's spacious, ergonomically-designed interiors are as practical as they are supremely comfortable. We've put everything in place so that you have space for all your items. Packing your Tucson is made easy, because our unique seat folding system enables each seat to be folded in a variety of ways, creating room for the most awkward of loads.

The clever use of space has created generous storage areas to accommodate just about anything you could possibly need on your journey. The flat cargo floor makes loading and unloading the boot easy. Other useful features include four cup holders, four bottle holders and a storage shelf under the steering column ideal for CDs and your mobile phone. The small details make a big difference such as the sunglass holder and shopping bag hooks.

Tucson's interior provides maximum convenience for your daily lifestyle needs.



*Hyundai Tucson City SX in New Mid Silver is accessorised with Genuine Hyundai Roof Racks (2 Bar Set), Surfboard Carrier, Style Visors, Side Steps, Rear Spoiler, Reverse Park Assist, Towbar, Towball, Trailer Wiring Harness, Fridge and Cargo Liner (sold separately). Luggage, surfboard and bike not included. All sold separately at additional cost.

Engineered for your safety

Your safety is our priority. We've applied advanced technology to create a vehicle that provides you and your passengers with maximum protection whatever the driving conditions.

The Tucson range comes with active safety features including ESP Stability Control and Traction Control System (TCS) standard on all models, delivering the ultimate in vehicle control and road handling.

Occupant protection is assured with passive safety features throughout the cabin including side impact bars, driver and front passenger SRS airbags, front seatbelt pretensioners with force limiters and height adjustable upper mounts, along with front and rear fog lamps for improved visibility in adverse weather conditions. Tucson City Elite goes further with six airbags, including front side thorax SRS airbags and cabin length side curtain SRS airbags for front and rear passenger impact protection.

For even more protection, the Tucson SX City and SX V6 are available with an optional Protectz Pack which includes front side (thorax) and curtain airbags.

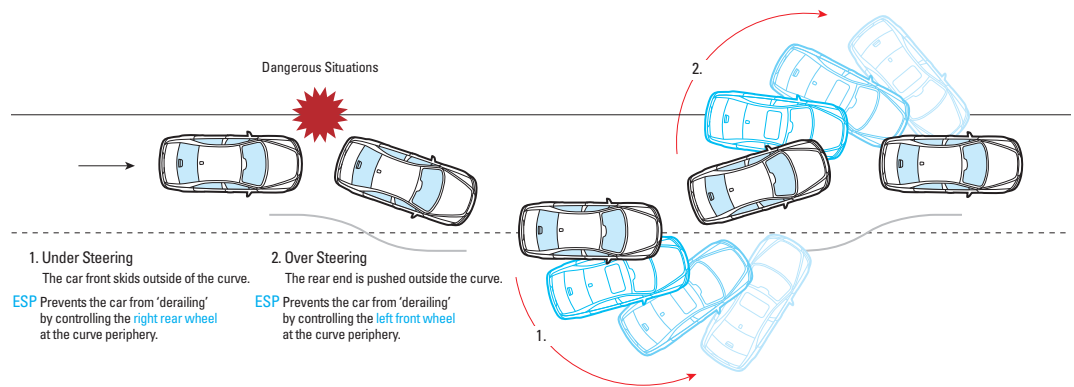

Airbags

The six airbag system standard on Tucson City Elite shields the cabin in the event of an impact, minimising any possible damage. It consists of driver and front SRS passenger airbags, front side (thorax) SRS airbags, and front and rear passenger side curtain SRS airbags.

Anti-skid Braking System (ABS)

Anti-Skid brakes (ABS) prevent the front wheels 'locking up' under heavy brake loads. This enables the driver to maintain steering control and avoid potentially dangerous situations while also minimising the total braking distance.

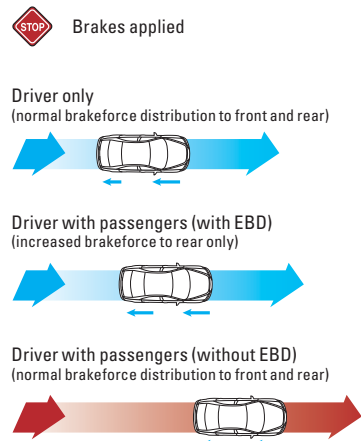

ESP Stability Control

ESP Stability Control works together with Traction Control System (TCS) to maintain vehicle control via computer electronics that use sensors to detect whether the car is travelling on its intended course. The moment it detects sliding or movement against the intended steering course, ESP automatically intervenes by reducing engine output, applies the brakes to individual wheels and even changes gear to bring the vehicle back on course.

Traction Control System (TCS)

Traction Control System (TCS) enables the driving wheels to maintain their grip on slippery or loose surfaces to provide driving force (acceleration) and steering control.

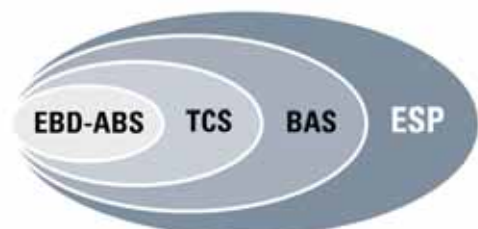

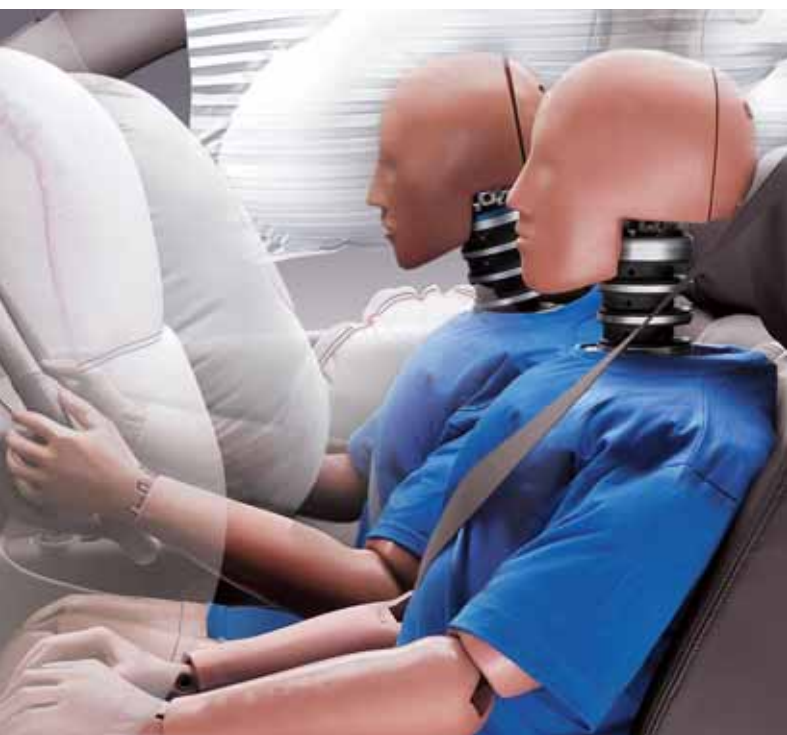

Perfect for your lifestyle





Born to perform



V6 AWD

Tucson V6 AWD is the all wheel drive that's tough when it counts. The all alloy 2.7L V6 quad cam engine boasts a maximum power output of 129kW and maximum torque of 241Nm. This power-pack has been matched to Hyundai's automatic transmission with Selectronic manual mode allowing you to change from automatic to manual with ease and precision. This transmission also features HiVec (Hyundai Intelligent Vehicle Electronic Control) which adapts to your driving style. Tucson V6 AWD delivers a braked towing capacity of 1500kg with fuel economy of 10.9 litres per 100kms¹.

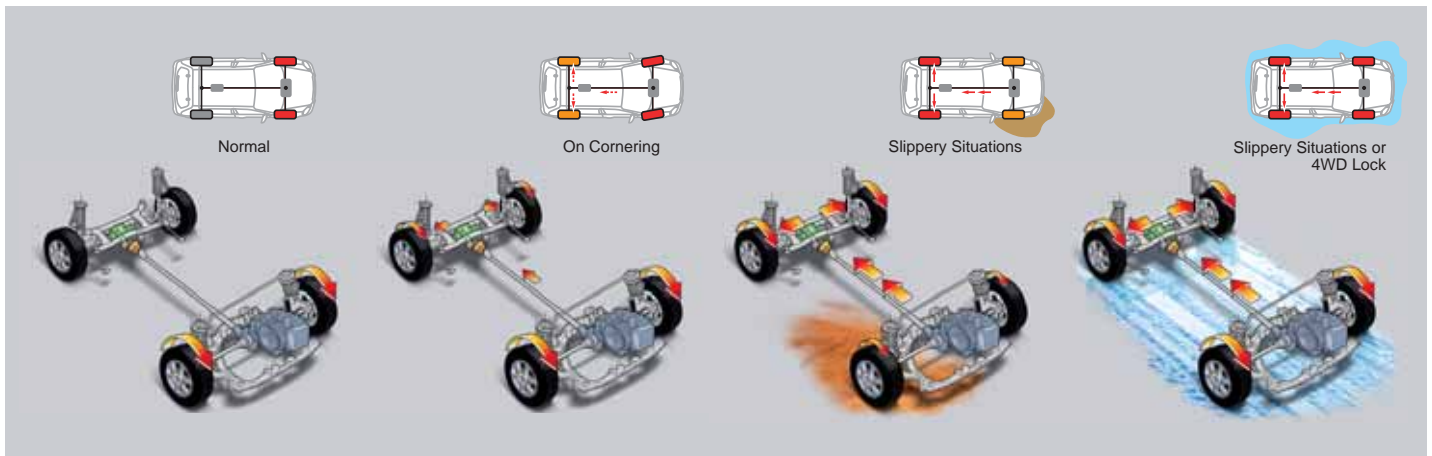

All-Wheel Drive (AWD) V6 Model

Test drive Tucson's interactive torque management All-Wheel Drive system and you'll be impressed by the level of control it delivers as road conditions or torque demand changes. Tucson senses the differences and directs the power according to the best combination for all four wheels. Future focused, smart thinking.



2.0L City

The spirited City makes city driving a breeze. Choose from the 5-speed manual or the 4-speed automatic transmission with Selectronic manual mode and HiVec. The 2.0 litre Continuously Variable Valve Timed (CVVT) twin cam engine delivers 104kW of power and 184Nm of torque to enable easy manoeuvring and economic cruising. An athletic power to weight ratio delivers an excellent fuel economy of just 8.0 litres per 100kms².

¹ Source: Australian Design Rule 81 /02. Tucson SX V6 Automatic; Combined 10.9L/100km, Urban 14.6L/100km; Extra 8.7L/100km. Fuel consumption will vary depending on a combination of driving habits, road conditions and the condition of the vehicle.

² Source: Australian Design Rule 81 /02. Tucson City SX Manual; Combined 8.0L/100km, Urban 10.4L/100km; Extra 6.6L/100km. Fuel consumption will vary depending on a combination of driving habits, road conditions and the condition of the vehicle.



Fully Featured



Dual 5-spoke, 16" alloy wheels (City)

The elegant 5-spoke, 16 inch alloy wheels with 215 section tyres are standard on the Tucson City range.



Flip up rear window

Forgotten to load something or need to access the luggage compartment without opening the whole tailgate? With Tucson's flip-up rear window nothing's a problem.



Air conditioning with pollen filter

With easy-to-use dials and buttons, the air conditioning features pollen filtration which allows you to breathe easily.



Centre console

Completely convenient, just where you need it, the front armrest opens to reveal organised space for your CDs and mobile phone.



5-spoke, 16" alloy wheels (SX V6)

The distinctive design of the 5-spoke, 16 inch alloy wheels with 235 series tyres provides better traction for on and off road conditions.



Bluetooth® Audio System

Listen to your favourite MP3 CDs with amazing clarity or talk on the phone using Bluetooth® wireless connectivity through the vehicle's audio system.



Cruise control

It's easy to maintain any speed limit and be fuel efficient thanks to cruise control.



Shopping bag hooks

Set exactly where you need them in the rear seat back, the shopping bag hooks keep your purchases upright and stop them from moving around.



2.0L engine (City)

Tucson City's 2.0 litre engine features Continuously Variable Valve Timing (CVVT) and the twin overhead cam has 104kW of power and 184Nm of torque to easily manoeuvre you in and out of the traffic.



Electric tilt or slide sunroof (City Elite)

Sunny days or navigation by the stars? The sunroof adds more sunlight and fresh air at the touch of a button.



Auto dusk sensing headlights

The Auto light "on/off" system senses when to turn the headlights on and off according to outside light levels, so you don't have to.



Luggage net and shelf

Securing awkwardly shaped or mobile loads isn't a problem. The luggage net keeps them simply and safely in place.

The full-width removable luggage shelf cover keeps outside eyes off your belongings.



2.7L V6 engine (SX V6)

The transverse mounted all alloy 2.7 litre quad cam V6 gives 129kW of power and 241Nm of torque in the Tucson V6 AWD models.



Trip computer

The trip computer provides drivers with information, including average litres per 100km, distance to empty, trip km, average speed and time taken.



Front seat and rear centre console cup holders

You and your rear seat passengers are never far away from your favourite beverage thanks to the conveniently located cup holders.



Luggage side tray

Clever side pockets hold your smaller items where you can see them.

All Genuine Hyundai Accessories are covered by Hyundai's Australian First 5 Year/Unlimited Kilometre Accessories Warranty*

Personalise your new Tucson with an exciting range of Genuine Hyundai Accessories designed and tested in accordance with Hyundai's strict safety standards to perfectly complement the vehicle's style and sophistication.

There is a range of Genuine Hyundai Accessories to suit everyone's needs, either to assist in the protection of the vehicle, enhance the look or personalise it to suit your lifestyle.

Personalise it, protect it and stylise it with Genuine Hyundai Accessories. Whoever you are, make it yours!



Hyundai Tucson City SX in New Mid Silver featured above is accessorised with Genuine Hyundai Roof Racks (2 bar set), Surfboard Carrier, Style Visors (Front pair only), Side Steps, Rear Spoiler, Reverse Park Assist, Towbar, Towball, Trailer Wiring Harness, Fridge and Cargo Liner. All sold separately at additional cost. Luggage, surfboard and bike not included.



Headlight Protectors (Set of 2) & Bonnet Protector (Sold separately)



Style Visors (Front pair only)



Rear Spoiler



Towbar, Towball & Trailer Wiring Harness¹ (Sold separately)



Reverse Park Assist² (4 head)



Ski & Snowboard Carrier



Side Steps

Other Genuine Hyundai Accessories available include:

Dash Mat

Roof Mounted Bike Rack

Surfboard Carrier

Carpet Floor Mats (Set of 4)

Fabric Rear Bumper Protector

Fridge – 12 volt 15 litre (Only suitable for use with retractable seatbelt)

Roof Racks³

Fold Down Cargo Box

Cargo Liner













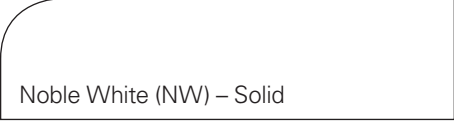

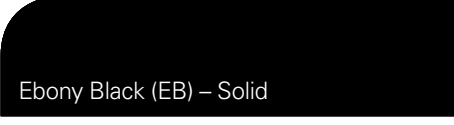
* All Accessories are subject to warranty conditions. Warranty only applies to purchases from 1 September 2008. See your nearest Hyundai Dealer or visit our website at hyundai.com.au for full warranty terms and usage recommendations. Accessories pictured are all sold separately at additional cost.

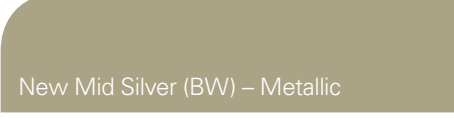
¹ Maximum ball download 120 kg (2.0L) or 150 kg (2.7L). Towbar 500 kg braked & 500 kg unbraked (2.0L Manual) 600 kg braked & 600 kg unbraked (2.0L Auto), 1500 kg braked & 750 kg unbraked (2.7L V6, Auto). Towbar capacity subject to regulatory requirements, Towbar design, vehicle design and towing equipment limitations.

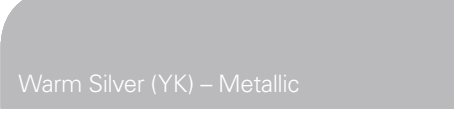
² Park Assist Sensors are designed as driver assist function only and should not be used as a substitute for skilled driving and safe parking practices. The area into which the vehicle is heading must be visually monitored by the driver while parking.

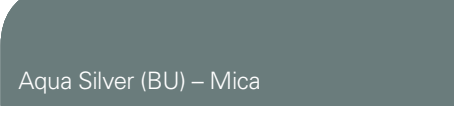
³ Roof Rack load capacity = 75 kg evenly distributed over 2 bars.

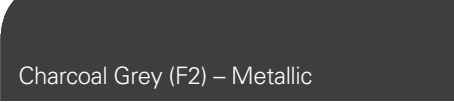
Stylish Finishes

City SX	City Elite	SX V6
 Charcoal Black Woven Cloth	 Charcoal Black Leather	 Charcoal Black Woven Cloth
 Noble White (NW) – Solid	 Noble White (NW) – Solid	 Noble White (NW) – Solid
 Ebony Black (EB) – Solid	 Ebony Black (EB) – Solid	 Ebony Black (EB) – Solid
 New Mid Silver (BW) – Metallic	 New Mid Silver (BW) – Metallic	 New Mid Silver (BW) – Metallic
 Warm Silver (YK) – Metallic	 Warm Silver (YK) – Metallic	 Warm Silver (YK) – Metallic
 Aqua Silver (BU) – Mica	 Aqua Silver (BU) – Mica	 Aqua Silver (BU) – Mica
 Charcoal Grey (F2) – Metallic	 Charcoal Grey (F2) – Metallic	 Charcoal Grey (F2) – Metallic

Car colours are indicative only and may vary due to the printing process.

Tucson confidence



Hyundai builds each and every vehicle using state-of-the-art technology to meet the world's highest quality standards. This confidence is supported by the fact that the company now offers Australia's First 5 Year/Unlimited Kilometre Factory Warranty¹ on all new Tucson vehicles as a standard promise of excellence. It is only because of our belief in the research and development behind every vehicle's design, the exceptional quality of materials and workmanship used in manufacturing, pre-delivery testing and an outstanding dealer network that Hyundai can back its product without any qualms, offering you complete confidence and peace of mind.

¹ The warranty extension to Unlimited Kilometres is only applicable to vehicles used for private and domestic uses and is not applicable to vehicles used for certain high mileage commercial purposes, i.e. courier, security and rental cars.

Hyundai's Australian First 5 Year Accessory Warranty



All Genuine Hyundai Accessories are covered by Hyundai's Australian First 5 Year/Unlimited Kilometre Accessories Warranty. All accessories are subject to warranty conditions. Warranty only applies to purchases from 1 September 2008. See your nearest Hyundai Dealer or visit our website at hyundai.com.au for full warranty terms and usage recommendations..



HYUNDAI

Tucson

◆ = Optional SX Protectz enhanced safety pack comprising driver and front passenger side (thorax) and curtain SRS airbags available to factory order

● = Standard ○ = Optional

Configuration	City	V6 AWD
Engine	Cast iron block and aluminium head	Aluminium alloy block and heads
Cylinder capacity	2.0 litres (1975 cc)	2.7 litres (2686 cc)
Number of cylinders	4 in-line DOHC	6 in "V"
Valve system	Twin overhead cam, 4 valves per cylinder (Twin cam, 16 Valves)	Twin overhead cam shaft per bank, 4 valves per cylinder (Quad cam, 24 Valves)
Maximum power	104 kW @ 6000 rpm	129 kW @ 6000 rpm
Maximum torque	184 Nm @ 4500 rpm	241 Nm @ 4000 rpm
Fuel System	Multi-point electronic fuel injection: tuned for 91-92 RON ULP	Multi-point electronic fuel injection: tuned for 91-92 RON ULP
Bore x stroke	82.0 mm x 93.5 mm	86.7 mm x 75.0 mm
Compression ratio	10:1:1	10:0:1
Transmission	City	V6 AWD
Drive train arrangement	Transverse front mounted driving front wheels	Transverse front mounted driving front and rear wheels. Electronically controlled on-demand Allwheel drive including driver selectable centre differential lock for 50/50 front/rear drive
Manual Automatic	5 speed	N/A
Manual Automatic	4 speed electronic automatic with HiVec (Hyundai intelligent vehicle electronic control) – adaptive to driver style, with overdrive lockout and lock up converter	4 speed electronic automatic with HiVec (Hyundai intelligent vehicle electronic control) – adaptive to driver style, with overdrive lockout and lock up torque converter
Gear ratio	Manual/Automatic	Automatic
1st	3.636/2.942	2.842
2nd	2.066/1.529	1.529
3rd	1.296/1.000	1.000
4th	0.943/0.712	0.712
5th	0.698/-	-
Reverse	3.455/2.480	2.480
Final drive ratio	4.333/4.626	4.042
Steering	City	V6 AWD
Type	Power assisted rack and pinion with steering wheel tilt adjustment	Power assisted rack and pinion with steering wheel tilt adjustment
Column	Energy absorbing dual collapsible steering column	Energy absorbing dual collapsible steering column
Minimum turning circle diameter between kerbs	10.8 metres	10.8 metres
Number of steering wheel turns lock-to-lock	3.06	3.06
Brakes	City	V6 AWD
General	Dual-diagonal, split circuit, power assisted with Electronic Brakeforce Distribution (EBD)	Dual-diagonal, split circuit, power assisted with Electronic Brakeforce Distribution (EBD)
Front	280 mm vented discs	280 mm vented discs
Rear	262 mm solid discs (284 mm solid disc on V6 AWD)	262 mm solid discs (284 mm solid disc on V6 AWD)
Dimensions	City	V6 AWD
Exterior	City	V6 AWD
Length/W/dth/Height	4325/1795/1730 mm	4325/1830/1730 mm
Wheelbase/Wheel track – front/rear	2630/1640 mm	2630/1550 mm
Minimum ground clearance (based on kerb weight)	186 mm	186 mm
Approach/departure/ramp break over angle	28.2/31.9/19 degrees	28.2/31.9/19 degrees
Interior	City	V6 AWD
Head room front/rear	1023/986 mm	1023/986 mm
Leg room front/rear	1070/945 mm	1070/945 mm
Shoulder room front/rear	1437/1430 mm	1437/1430 mm
Hip room front/rear	1330/1300 mm	1330/1300 mm
Cargo overall length/height	1320/918 mm	1320/918 mm
Cargo overall width (between wheel arches)	1000 mm	1000 mm
Cargo volume: seats up/down	644/1856 SAE litres; 325/805 litres (VDA 213/214)	644/1856 SAE litres; 325/805 litres (VDA 213/214)
Weight	City	V6 AWD
Kerb/GVM Manual	1539/2200 kg	1666/2220 kg
Kerb/GVM Automatic	1554/2200 kg	1666/2220 kg
Towing Capacity	City	V6 AWD
Unbraked trailer	500 kg (Manual/600 kg (Automatic)	750 kg
Braked trailer	500 kg (Manual/600 kg (Automatic)	1500 kg
Maximum towball weight	120 kg	150 kg
Roof cross bars load limit	75 kg	75 kg
Fuel Figures ADR81/02¹	Manual	Automatic
Combined (L/100km)	8.0	9.2
Urban (L/100km)	10.4	12.1
Extra (L/100km)	6.6	7.6
CO ₂ (Combined) (g/km)	190	220
Fuel tank capacity (L)	58	58

Suspension	City SX	City Elite	SX V6
Independent McPherson struts with coil springs and anti-roll stabiliser bar	●	●	●
Telescopic, gas, double acting shock absorbers (front and rear)	●	●	●
Wheels & Tyres	City SX	City Elite	SX V6
Dual 5-spoke 16" x 6.5J alloy wheels	●	●	—
215/65 R16 tyres	●	●	—
5-spoke 16" x 6.5J alloy wheels	—	—	●
235/60 R16 tyres	—	—	●
Spare full size tyre on standard alloy wheel rim	●	●	●
Active Safety	City SX	City Elite	SX V6
Anti-skid Braking System (ABS)	●	●	●
4 channel	●	●	●
Electronic Brakeforce Distribution (EBD)	●	●	●
Brake Assist System (BAS)	●	●	●
ESP Stability Control	●	●	●
Traction Control System (TCS)	●	●	●
Front fog lamps	●	●	●
Rear fog lamps	●	●	●
Rear high mount centre stop lamp	●	●	●
Warning lights (seatbelt, door ajar, check engine)	●	●	●
Day/night rear-view mirror	●	●	●
Auto dusk-sensing with override switch	●	●	●
Passive Safety	City SX	City Elite	SX V6
Airbags	City SX	City Elite	SX V6
Driver and front passenger SRS airbags	●	●	●
Driver and front passenger side (thorax) SRS airbags	◆	◆	◆
Front and rear passenger side curtain SRS airbags	◆	◆	◆
Body	City SX	City Elite	SX V6
Side impact intrusion bars in all doors	●	●	●
Impact absorbing bumpers	●	●	●
Child safety rear door locks	●	●	●
Anti-submarining front seat pans	●	●	●
Seatbelts	City SX	City Elite	SX V6
Pretensioners, load limiters and height-adjustable upper mounts on front seatbelts	●	●	●
3 point retractable seatbelts for all occupants	●	●	●
Seating	City SX	City Elite	SX V6
3 child seat anchor point brackets in rear	●	●	●
Height-adjustable head restraints	●	●	●
Exterior Styling	City SX	City Elite	SX V6
Body-colour door mirror shells/door handles	●	●	●
Electric tilt or slide glass sunroof (with interior sliding blind)	—	—	—
Twin chrome oval exhaust outlets	●	●	●
Body coloured protective cladding on lower door and wheel arches matching front and rear bumper	●	●	●
Roof rails	●	●	●
Front and rear mud flaps	●	●	●
Rear roof mounted 'bee-sting' aerial	●	●	●

Sound System	City SX	City Elite	SX V6
MP3/WMA/CD player with AM/FM tuner with security PIN code	●	●	●
4 speakers	●	—	●
6 speakers including tweeters	—	●	—
Auxiliary input jack	●	●	●
USB audio input	●	●	●
Bluetooth® media connectivity	●	●	●
Bluetooth® handsfree mobile connectivity with phonebook capabilities	●	●	●
3 shopping bag hang hooks (front passenger console, 2 on rear seat backs)	●	●	●
Lockable, illuminated glove box with divider	●	●	●
Centre fascia ticket holder/card slot	●	●	●
Storage compartments under door pull handles and in centre dash	●	●	●
Retractable cargo area security blind with forward flaps	●	●	●
Rear elasticised storage net with flat or hammock mounting	●	●	●
Storage compartments with elastic net in side wall of cargo area	●	●	●
Storage shelf under steering column	●	●	●
Storage compartments under cargo area floor cover	●	●	●
Genuine Hyundai Accessories²	City SX	City Elite	SX V6
Interior	City SX	City Elite	SX V6
Universal Carpet Floor Mats (Set of 4)	●	●	●
Tailored Carpet Floor Mats (Set of 4)	●	●	●
Rubber Floor Mats (Set of 4)	●	●	●
Dash Mat	●	●	●
Cargo Liner	●	●	●
Fabric Rear Bumper Protector	●	●	●
Fold Down Cargo Box	●	●	●
Fridge – 12 V 15 L (Only suitable for use with retractable seatbelt)	●	●	●
Exterior	City SX	City Elite	SX V6
Headlight Protectors (Set of 2)	●	●	●
Bonnet Protector	●	●	●
Style Visors (Front pair only)	●	●	●
Side Steps	●	●	●
Towbar ³	●	●	●
Towball – 50 mm chrome	●	●	●
Trailer Wiring Harness (Includes flat pin)	●	●	●
7 Pin Large Round Adaptor	●	●	●
7 Pin Small Round Adaptor	●	●	●
Chrome Wheel Nuts	●	●	●
Universal Lock Nuts (Set of 4)	●	●	●
Styling	City SX	City Elite	SX V6
Rear Spoiler	●	●	●
Roof Racks and Lifestyle	City SX	City Elite	SX V6
Roof Racks ⁴ (2 bar set)	●	●	●
Roof Rack Locks (Set of 4)	●	●	●
Roof Mounted Bike Rack	●	●	●
Snow Pro Ski Carrier	●	●	●
Surfboard Carrier	●	●	●
Safety	City SX	City Elite	SX V6
First Aid Kit (4 Pocket)	●	●	●
Reverse Park Assist ⁵ (4 head)	●	●	●

Storage Solutions	City SX	City Elite	SX V6
Front seat back pocket	●	●	●
Centre floor console with twin storage bins and height-adjustable padded arm rest	●	●	●
2 cup holders in front centre floor console	●	●	●
Fold down rear armrest with twin cup holders	●	●	●
Map pockets with bottle bulges in all door trims	●	●	●
3 shopping bag hang hooks (front passenger console, 2 on rear seat backs)	●	●	●
Lockable, illuminated glove box with divider	●	●	●
Centre fascia ticket holder/card slot	●	●	●
Storage compartments under door pull handles and in centre dash	●	●	●
Retractable cargo area security blind with forward flaps	●	●	●
Rear elasticised storage net with flat or hammock mounting	●	●	●
Storage compartments with elastic net in side wall of cargo area	●	●	●
Storage shelf under steering column	●	●	●
Storage compartments under cargo area floor cover	●	●	●
Genuine Hyundai Accessories²	City SX	City Elite	SX V6
Interior	City SX	City Elite	SX V6
Universal Carpet Floor Mats (Set of 4)	●	●	●
Tailored Carpet Floor Mats (Set of 4)	●	●	●
Rubber Floor Mats (Set of 4)	●	●	●
Dash Mat	●	●	●
Cargo Liner	●	●	●
Fabric Rear Bumper Protector	●	●	●
Fold Down Cargo Box	●	●	●
Fridge – 12 V 15 L (Only suitable for use with retractable seatbelt)	●	●	●
Exterior	City SX	City Elite	SX V6
Headlight Protectors (Set of 2)	●	●	●
Bonnet Protector	●	●	●
Style Visors (Front pair only)	●	●	●
Side Steps	●	●	●
Towbar ³	●	●	●
Towball – 50 mm chrome	●	●	●
Trailer Wiring Harness (Includes flat pin)	●	●	●
7 Pin Large Round Adaptor	●	●	●
7 Pin Small Round Adaptor	●	●	●
Chrome Wheel Nuts	●	●	●
Universal Lock Nuts (Set of 4)	●	●	●
Styling	City SX	City Elite	SX V6
Rear Spoiler	●	●	●
Roof Racks and Lifestyle	City SX	City Elite	SX V6
Roof Racks ⁴ (2 bar set)	●	●	●
Roof Rack Locks (Set of 4)	●	●	●
Roof Mounted Bike Rack	●	●	●
Snow Pro Ski Carrier	●	●	●
Surfboard Carrier	●	●	●
Safety	City SX	City Elite	SX V6
First Aid Kit (4 Pocket)	●	●	●
Reverse Park Assist ⁵ (4 head)	●	●	●

¹ Sources: Australian Design Rule 81/02 static laboratory combined average city & highway cycle test. Fuel consumption will vary depending on a combination of driving habits and the condition of the vehicle. ² All Genuine Hyundai Accessories are covered by Hyundai's Australian First 5 Year/Unlimited Kilometre Warranty. All Accessories are subject to warranty conditions. Warranty only applies to purchases from 1 September 2008. See your nearest Hyundai Dealer or visit our website at www.hyundai.com.au for full warranty terms and usage recommendations. Accessories are all sold separately at additional cost. ³ Maximum ball download 120kg (2.0L) or 150kg (2.7L). Towbar 500kg braked & 500kg unbraked (2.0L Manual) or 600kg braked & 600kg unbraked (2.0L Auto) or 1500kg braked & 750kg unbraked (2.7L Auto). Towbar capacity subject to regulatory requirements. ⁴ Roof Racks load capacity = 75kg evenly distributed across 2 bars. ⁵ Park Assist Sensors are designed as driver assist function only and should not be used as a substitute for skilled driving and safe parking practices. The area into which the vehicle is heading must be visually monitored by the driver while parking.



HYUNDAI
Drive your way™

Hyundai Motor Company Australia Pty Ltd Corner of 394 Lane Cove Road & Hyundai Drive, Macquarie Park NSW 2113 T.02 8873 6000 F.02 8873 6005

Hyundai Motor Company (HMC) and the Hyundai Motor Company Australia (HMCA) each reserve the right to alter vehicle specifications and equipment levels without notice. Some equipment featured on the cars in this brochure may not be available in Australia or may be optional. To the extent permitted by the law, neither HMC nor HMCA shall be liable to any person as a result of reliance on the content of this brochure. Please consult your Hyundai dealer for the latest specifications, equipment levels, options, prices, colours and vehicle availability. Metallic and mica paint are optional extras.

Note: Information in this brochure is current as at 20/04/2009. **Part No. TUC0409B**



HYUNDAI
A-LEAGUE