

ALL 4
THE RUNNING AROUND
THE FAMILY FUN
THE WEEKENDS
THE GETAWAY
THE FORESTER DRIVER



FORESTER | 2011

ALL 4 THE DRIVER™



SUBARU

ALL 4
THE
WEEKEND





IMAGE: FORESTER XS PREMIUM



ALL 4 THE DRIVER™

All 4 the Driver™ is far more than a simple phrase for those of us that work for Subaru. It's a philosophy that ensures a culture that's united in its passion for putting you, our customer, first.

Basically, it's about creating an extraordinary experience for you, each and every time. It means we have an uncompromising commitment to quality, especially in our dealings with you and how we make you feel. At Subaru we are all accountable for making All 4 the Driver a real experience for you. And we're all motivated by that challenge.

To find the Subaru that is right for you - don't take our word for it, Drive It Your Way®. After all, there's only one way to find out how a Subaru feels, and that's by getting behind the wheel. Put your favourite Subaru to the test on the kind of roads where you need it to perform most - from a quick, local dash around the block, to a longer freeway cruise, there's a test drive route to suit you. Ask your local Subaru Retailer for details.



Symmetrical All-Wheel Drive
Horizontally-opposed Boxer engine
Five-star ANCAP occupant safety

ALL 4 THE PERFORMANCE, THE SAFETY, THE RETAINED VALUE

Performance

Our Symmetrical All-Wheel Drive and horizontally-opposed Boxer engine technology have been developed to work together to provide superior handling, performance and balance - which gives our Drivers greater confidence. Confidence that makes for pure driving pleasure.

Safety

Thanks to its uniquely balanced design, every Subaru is made to grip the road in just about any condition. A ring-shaped passenger safety cell and advanced crumple zone technology help protect Subaru Drivers and passengers from serious injuries. It's part of the reason every Subaru is awarded a five-star ANCAP occupant safety rating – the highest occupant safety rating available in Australia – ensuring a worry-free trip, wherever you're heading.

Retained Value

Excellent retained value is no accident. Subaru starts with outstanding cars, adds world famous advanced driving technologies and provides every owner with maximum five-star occupant safety. But it doesn't end there. Our highly skilled service technicians at over 100 Subaru service centres around Australia ensure your Subaru is kept in peak condition at all times. Subaru has had an active focus on the retained value of all our models for many years. This is the result of delivering exceptional performance, safety technologies and DataDot™ theft protection to ensure that owning a Subaru is a good investment.

ALL OF THIS ADDS UP TO A BETTER EXPERIENCE FOR THE DRIVER.



THE
DIFFERENCE
IS OUR
DNA



ALL 4 THE MUD THE SWEAT THE CHEERS THE SUBARU DRIVER



Rallying has always been a brutally tough motorsport. With uncompromising terrain, wildly fluctuating conditions, and constant demands on the cars, it's one of the most challenging sports in the world – and a perfect testing ground for Subaru. We were part of the World Rally Championship for 19 years – and while we were fine-tuning our unique technologies, we were also winning championships. We won the World Rally Championship Manufacturers' title three times, and the driver's title three times as well.

And our decade of dominance in the Australian Rally Championship – from 1996 to 2005 – is a testament not only to our ongoing passion for innovative design and engineering, but our unique understanding of Australian driving conditions. It's a passion that flows through our earliest designs and drawings, into our race-bred testing regime, and into the car you drive.

Pioneering performance since 1958

From the introduction of the Subaru 360 in 1958 to Subaru's three consecutive World Rally Championship (WRC) Manufacturers' titles from 1995 to 1997, Subaru has a long history of engineering and motor sports achievement. Here's a quick look at the Subaru journey...



AUSTRALIAN
MANUFACTURERS'
CHAMPION



AUSTRALIAN RALLY DRIVER'S
CHAMPIONSHIP

ALL 4 THE SUBARU HERITAGE

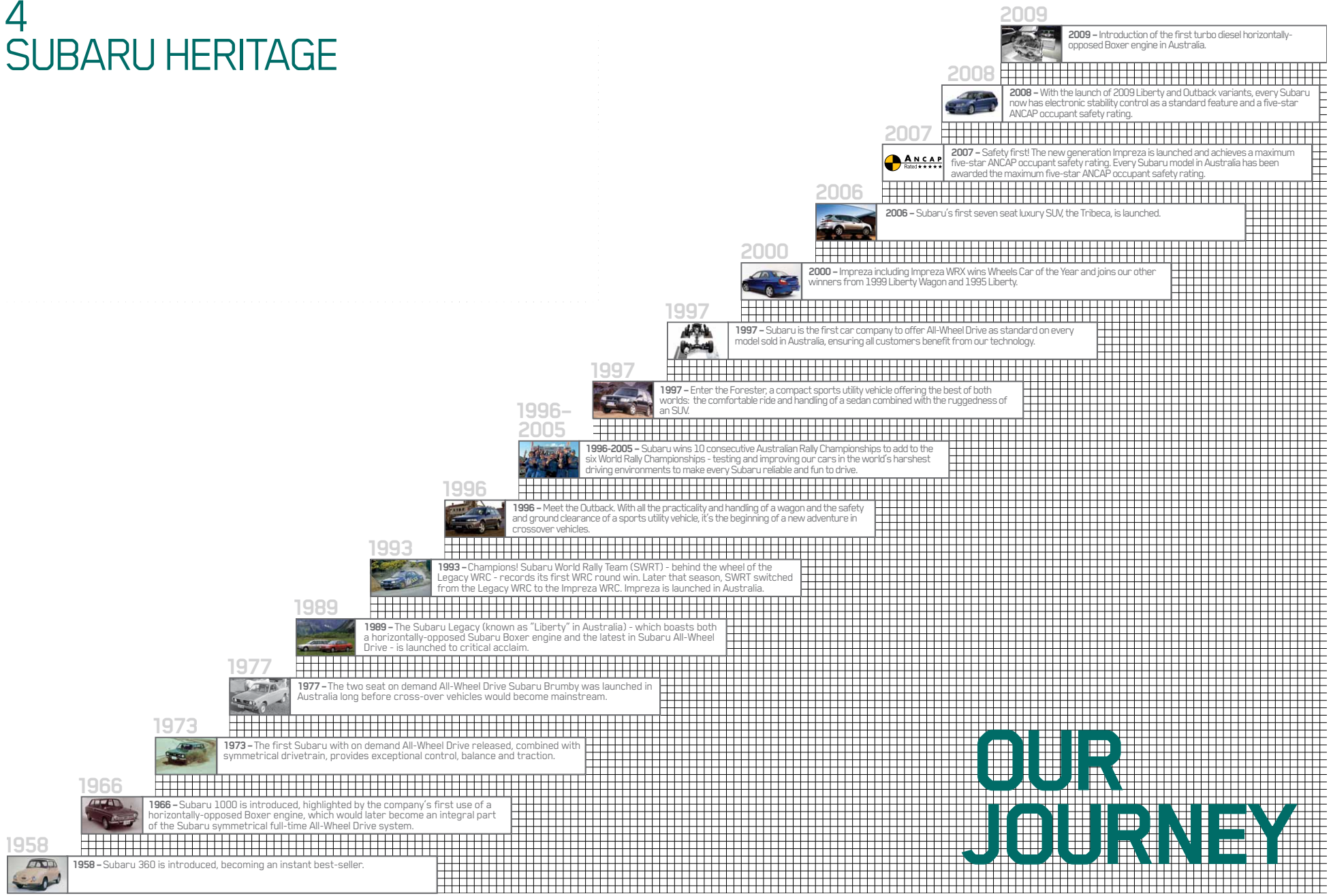

OUR JOURNEY





ALL 4 THE WEEKENDS THE GETAWAY THE DISCOVERY

Confidence

It reveals itself in the corners. In the wet. In the moments when it really counts. It's the same confidence that turns an everyday drive into an exhilarating ride. That's why we've made driver confidence the cornerstone of everything we do at Subaru. Every innovation, every technological advancement, every intricate detail in a Subaru is there to inspire confidence. And give you a more enjoyable drive, whatever road you're travelling on.

Get more done. Have more fun.

Adventure is one of those things that can be weeks in the planning, or just sort of happen. It can mean off-road explorations, or just taking the road less travelled. Every adventure's different. And that's precisely the inspiration behind the Subaru Forester. To give you the capability and flexibility you need to getaway.

It starts with the sure-footed control and car-like handling of Subaru's Symmetrical All-Wheel Drive, and the effortless power of the horizontally-opposed Boxer engine. It's there in the strong, rugged and robust exterior, the comfortable and spacious interior and of course, the impeccable technology and class-leading safety credentials.

Forester. Get more done and have more fun.

IMAGE: FORESTER XT

ALL 4 THE FEELING ON THE INSIDE

From the slopes to the Simpson, the city avenues to the country tracks, wherever you take your Forester, you're always going to be surrounded by something beautiful. The interior has been designed to ensure you and your passengers always travel in style and comfort.

Everything's within easy reach and everyone's got plenty of space, thanks to the ergonomic design of the cabin. The front seats are adjustable, so you can set yours just how you like it - and you can do the same with the steering wheel. While the rear seats incline, making every trek a comfy one.

Plus, there's all the latest technologies and creature comforts like *Bluetooth*^{®1} wireless technology and power windows, mirrors and steering.

Forester - perfect for any adventure.

1. *Bluetooth*[®] is a registered trademark of Bluetooth SIG Inc. System operation ability is subject to the *Bluetooth*[®] wireless technology specification of individual's phone.

IMAGE: FORESTER XT PREMIUM





FORESTER X

There's a reason the Forester X is the benchmark in its class. In fact, there are several. There's the fact that despite being exceedingly roomy and comfortable, it still offers car-like handling – thanks to the inherent balance and stability of Symmetrical All-Wheel Drive combined with our Boxer engine.

There's also the impressive list of standard features – from air-conditioning to steering wheel cruise controls, from power steering and mirrors to the in-dash single CD player with an auxiliary jack¹ and USB port¹ that allow control of your MP3 player through the steering wheel buttons, which means your favourite songs are only a touch away. The inclusion of *Bluetooth*[®] wireless technology² also gives you easy hands free calling from your mobile phone.

And of course, the six airbags, Vehicle Dynamics Control system and collision protection technologies have seen the Forester X awarded the maximum five-star ANCAP³ occupant safety rating.

With all these features, it's no wonder it's the benchmark in its class.

ALL 4
THE COMFORT
THE ROOM
THE CAPABILITY
THE DRIVER

1. Auxiliary jack and USB port not available when optional satellite navigation is fitted.
2. *Bluetooth*[®] is a registered trademark of Bluetooth SIG Inc. System operation ability is subject to the *Bluetooth*[®] wireless technology specification of individual's phone.
3. The Australasian New Car Assessment Program (ANCAP) gives consumers consistent information on the level of occupant protection provided by vehicles in serious front and side crashes.

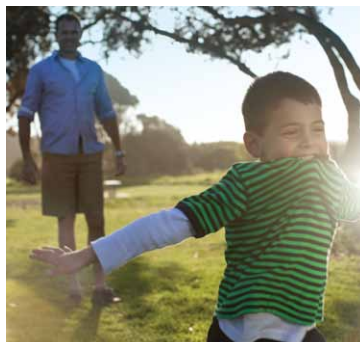

IMAGE: FORESTER X
CENTRE: USB PORT AND AUXILIARY JACK
FAR LEFT: SINGLE IN-DASH CD PLAYER







IMAGE: FORESTER XS PREMIUM
CENTRE: FORESTER XS AUDIO AND *BLUETOOTH*[®]
STEERING WHEEL CONTROL SWITCHES
FAR RIGHT: 17-INCH ALLOY WHEEL

The versatile Forester XS and Forester XS Premium are designed for the truly adventurous at heart. The 2.5-litre Boxer engine delivers a punchy 126kW of power at 5,800rpm and 235Nm of torque at 4,100rpm, giving you the confidence to roam freely.

And they're both stacked with extras – like 17-inch alloys, front fog lights, rear privacy glass and self-levelling rear suspension. Not to mention the luxurious touches such as climate control air-conditioning, leather steering wheel and gear shift, plus a multi-function retractable rear tray with cup holders, making it even more comfortable for your rear passengers.

The premium audio entertainment system features six speakers including a subwoofer, plus an LCD¹ screen that displays all your audio information, acts as a rear

view reverse camera and lets you share your favourite pictures. An auxiliary jack² and USB port² allow control of your MP3 player through the steering wheel buttons, which means your favourite songs are only a touch away. And *Bluetooth*[®] wireless technology³ with voice recognition provides hands free calling from your mobile phone.

The Forester XS Premium adds leather⁴ seats, electric sunroof, eight-way power driver's seat and an optional multi-information satellite navigation system that has *Bluetooth*[®] wireless technology³, a single CD/DVD⁵ player and a rear view reverse camera.

With this many features, you'll never want the adventure to end.

1. Information display and operation ability is subject to compatibility of the *Bluetooth*[®] audio device to AVRCP and some functions may be restricted.
2. Auxiliary jack and USB port not available when optional satellite navigation is fitted.
3. *Bluetooth*[®] is a registered trademark of Bluetooth SIG Inc. System operation ability is subject to the *Bluetooth*[®] wireless technology specification of individual's phone.
4. Some parts of seating are not full natural leather.
5. DVD only operates when vehicle is stationary.



FORESTER XS AND FORESTER XS PREMIUM

ALL 4
THE VERSATILITY
THE STYLE
THE ADVENTURE
THE DRIVER



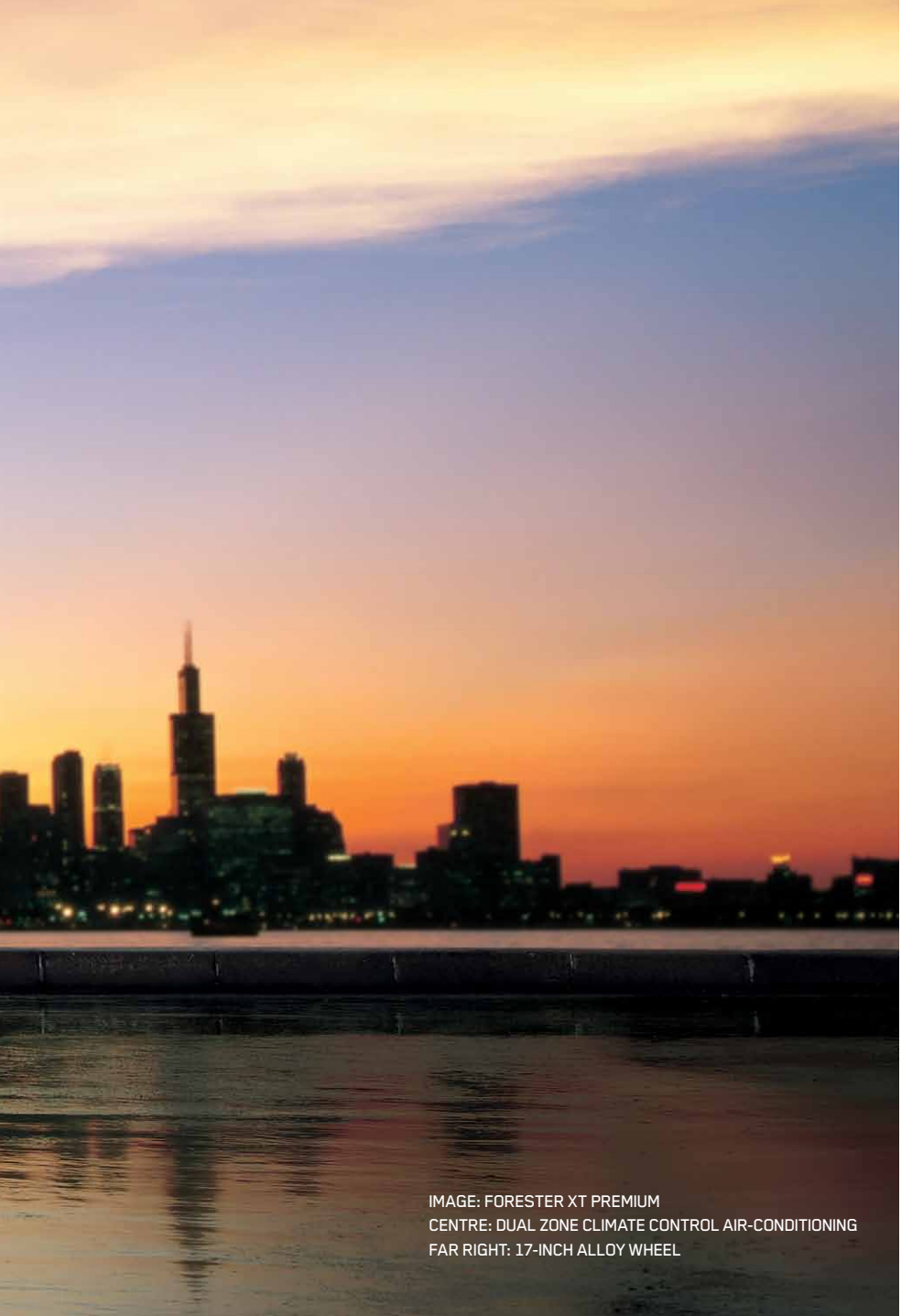

IMAGE: FORESTER XT PREMIUM
CENTRE: DUAL ZONE CLIMATE CONTROL AIR-CONDITIONING
FAR RIGHT: 17-INCH ALLOY WHEEL

The luxurious Forester XT and Forester XT Premium combine all the grandeur of a top-of-the-range SUV with the power of a premium sports car. Beneath the distinctive bonnet scoop lurks a 2.5-litre turbocharged Boxer engine with an impressive 169kW of power at 5,200rpm, and 320Nm of torque at 2,800rpm.

The premium audio entertainment system features six speakers including a subwoofer, plus an LCD¹ screen that displays all your audio information, acts as a rear view reverse camera and lets you share your favourite pictures. An auxiliary jack² and USB port² allow control of your MP3 player through the steering wheel buttons, which means your favourite songs are only a touch away. And *Bluetooth*[®] wireless technology³ with voice recognition provides hands free calling from your mobile phone.

And while there's plenty of power under your right foot, the Electronic Throttle Control built into every Forester XT and Forester XT Premium ensures sharp responsiveness at all times. The car even looks adventurous, with go-anywhere 17-inch alloys, low beam Xenon headlights with auto off, a sporty rear roof spoiler, leather steering wheel and gearshift, plus dual zone climate control air-conditioning so you travel everywhere in style.

The Forester XT Premium adds luxury. Leather⁴ seats, electric sunroof, an eight-way power driver's seat, a multi-information satellite navigation system, *Bluetooth*[®] wireless technology³, a single CD/DVD⁵ player, RCA jacks⁶ and a rear view reverse camera. Giving you total control from the comfort of the driver's seat. With all these features, you soon realise this is no ordinary SUV.

- 1. Information display and operation ability is subject to compatibility of the *Bluetooth*[®] audio device to AVRCP and some functions may be restricted.
- 2. Auxiliary jack and USB port not available when optional satellite navigation is fitted.
- 3. *Bluetooth*[®] is a registered trademark of Bluetooth SIG Inc. System operation ability is subject to the *Bluetooth*[®] wireless technology specification of individual's phone.
- 4. Some parts of seating are not full natural leather.
- 5. DVD only operates when vehicle is stationary.
- 6. RCA jacks replace auxiliary jack and USB port when optional satellite navigation is fitted.

FORESTER XT AND FORESTER XT PREMIUM

ALL 4
THE PERFORMANCE
THE AGILITY
THE ESCAPE
THE DRIVER







IMAGE: FORESTER 2.0D PREMIUM
 CENTRE: REAR RETRACTABLE CENTRE CUSHION TABLE
 WITH CUPHOLDERS
 FAR RIGHT: FORESTER 2.0D SINGLE IN-DASH CD PLAYER

Main roads. Back roads. No roads. The Subaru Forester 2.0D combines the flexibility Forester is famous for, with even longer legs to help you drive over 1,000km¹ on a single tank. Bringing further closer.

Powered by our 2.0-litre horizontally-opposed turbocharged Boxer Diesel engine and a six-speed manual transmission, with Vehicle Dynamics Control and the all road traction of Subaru's Symmetrical All-Wheel Drive system – the Forester 2.0D cuts down on fuel, while losing none of the adventure and meeting EURO5 emission standards.

And it's also nice to have the confidence of knowing Forester has been awarded the maximum five-star occupant safety rating from ANCAP.

You'll find the Forester 2.0D packed with convenient features like climate control air-conditioning, a single CD player with auxiliary jack² and USB port², *Bluetooth*[®] wireless technology³, power windows and mirrors, rear privacy glass, 16-inch alloy wheels and a hill start assist system for easy starts on those steep hills.

Choose the Forester 2.0D Premium model and you'll also enjoy a single in-dash CD player with LCD screen that displays all your audio information and acts as a rear view reverse camera, 17-inch alloy wheels, large electric sunroof, bright Xenon low beam headlights and the extra comfort of leather⁴ seats including an eight-way power driver's seat.

Optional satellite navigation is also available on Forester 2.0D Premium.

1. Based on a highway cycle of 5.7L per 100km and fuel capacity of 64L tested in accordance with ADR81/02.
 2. Auxiliary jack and USB port not available when optional satellite navigation is fitted.
 3. *Bluetooth*[®] is a registered trademark of Bluetooth SIG Inc. System operation ability is subject to the *Bluetooth*[®] wireless technology specification of individual's phone.
 4. Some parts of seating are not full natural leather.



FORESTER 2.0D AND FORESTER 2.0D PREMIUM

ALL 4
 THE DISTANCE
 THE SAFETY
 THE JOURNEY
 THE DRIVER







IMAGE: FORESTER S-EDITION
CENTRE: SPORTY INSTRUMENT CLUSTER
FAR RIGHT: 17-INCH STI ALLOY WHEELS

For decades Subaru STI engineers crafted World Rally winning cars, picking up six World Championships along the way. Across the way, other Subaru engineers have been working hard since 1972 to create even better All-Wheel Drive SUVs. Now they've got together and poured everything they both know into one almighty Subaru, the sensational STI enhanced Forester S-EDITION.

Beneath the tell-tale bonnet scoop lurks our famous turbocharged Subaru Boxer engine producing a whopping 193kW of power and 347Nm of torque. And Subaru Symmetrical All-Wheel Drive makes sure that all that power is transferred to the road rather than lost in wheel spin. Making for a truly gripping experience.

Subaru didn't stop there and had the driver and passengers in mind when they added features to make even the toughest World Rally winning driver smile...

- 17-inch light weight STI high lustre alloy wheels for grip
- A sports roof spoiler for better aerodynamics
- Alcantara and leather¹ trim with S-EDITION logos for comfort and style
- Electric sunroof to enjoy the moment
- Eight-way power driver's seat for a driving position that suits you
- A multi-information satellite navigation system to help you explore your boundaries
- A single CD player with rear view reverse camera
- *Bluetooth*[®] wireless technology² so you can brag while driving

Did you want more?

- STI enhanced sports suspension
- Sports pedals for grip
- Electroluminescent instruments for ease of sight
- Five-speed automatic transmission with paddle gear shift to suit your mood
- Leather steering wheel and gear shift for driver grip and control

No matter your choice of colour, your friends will be green with envy.

1. Some parts of seating are not full natural leather.
2. *Bluetooth*[®] is a registered trademark of Bluetooth SIG Inc. System operation ability is subject to the *Bluetooth*[®] wireless technology specification of individual's phone.

FORESTER S-EDITION

**ALL 4
THE THRILL
THE AGILITY
THE ESCAPE
THE DRIVER**



ALL OR NOTHING

We pioneered Symmetrical All-Wheel Drive (SAWD) nearly 40 years ago and it remains one of our defining achievements. The combination of SAWD and Subaru Vehicle Dynamics Control system (VDC) optimises tyre traction and provides the driver with outstanding control.

Partnered with our horizontally-opposed Boxer engine, and symmetrical drivetrain, it gives you a sense of poise and balance that not only inspires confidence, but delivers optimum safety – whatever the conditions.



The benefit of symmetry

The drivetrain of your Subaru is perfectly symmetrical with the engine, transmission, propeller shaft and rear differential all arranged in a straight line.

The result is ideal weight distribution, a low centre of gravity, and perfect balance giving you sure-footed control, and smooth, receptive handling.

Three distinctive advantages

1. Better balance

A low centre of gravity means less body roll, flatter cornering and improved response with the benefits of SAWD grip.

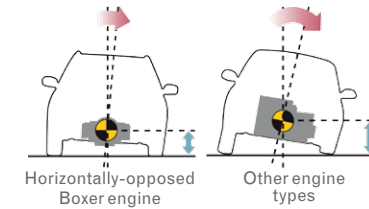

2. Less vibration

Our horizontally-opposed Boxer engines are flat in shape and sit low in the engine bay, meaning less vibration, noise and greater cabin comfort.

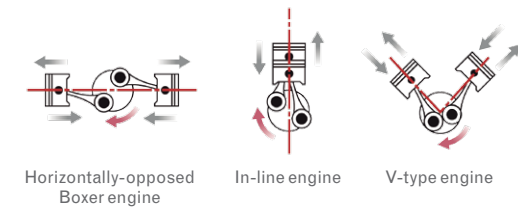

3. More grip and traction

SAWD offers distinct advantages over two-wheel drives when cornering by optimising traction and reducing the likelihood of oversteer or understeer.



Transfers power from the wheels that slip to those with grip

Sure-footed control

The sense of control you feel behind the wheel owes a lot to our intelligent chassis design and finely tuned suspension.

The light but rigid materials in the chassis give the car extra agility, and the McPherson strut-type independent front suspension, a double wishbone rear suspension and speed sensitive power-assisted steering combine to provide a smooth, controlled ride, with lots of road-holding grip.



Constant contact

The more your tyres are engaged with the road, the more control you have. Power is delivered to all four tyres all of the time in order to maintain the strongest connection to the road, maximising handling and control.

Agility in an emergency

In bad weather, or in the precious seconds it takes to react to an emergency situation, the symmetrical drivetrain with almost perfect balance provides the stability, agility and traction that help when you need it most.

Suspension

Forester's strut type front and double wishbone rear suspension has been extensively refined to inspire even greater handling confidence. Innovative shock-absorber valves and optimised tuning respond with precision, even to minor movements of the wheels - enhancing tyre contact.

The compact rear suspension allows for a roomier, more useful cargo area, and in Forester XS, Forester XT and Forester 2.0D models it even adjusts to heavy loads with a self levelling feature - ensuring a constant ride height for changes in cargo load. This system maintains a balanced front/rear ride height which means no change to steering response and is therefore ideal for towing.

Wide tread, a long stroke and impressive ground clearance, balance authentic SUV capability with a quiet ride and sporty, surefooted handling.

Suspension for the Forester S-EDITION has also been tuned for a more sports orientated ride and handling.



Front suspension



Rear suspension

ALL 4 THE EXHILARATION

Few other SUVs drive with the fun and eagerness of Forester, so you won't be surprised by how it is accomplished. The horizontally-opposed configuration of the Subaru Boxer engine places the pistons 180 degrees apart, for a lower, flatter profile than other engine types. This gives the engine, and the overall vehicle, a lower centre of gravity and better balance. Further, the pistons' opposing movements counteract each other, naturally helping to reduce vibration.

You feel the difference on your very first drive. That quiet, smooth acceleration and light-footed responsiveness that has become the hallmark of the horizontally-opposed Subaru Boxer engine. Tuned for mid-range torque as well as top-end power, it offers the driver impressive performance at all times – even when carrying a big load.

The 2.5-litre four-cylinder new generation Subaru Boxer engine delivers enhanced output, efficiency and emissions whilst sharing all the legendary benefits of the 11 million Subaru Boxer engines already produced. The engine outpaces the demands of tomorrow while retaining all the time-proven benefits, from smooth responsive and economical power delivery to more balanced handling. A new longer-stroke design revs eagerly while delivering more efficient combustion. Air, fuel and temperature are more precisely controlled, reducing fuel consumption and exhaust emissions while at the same time increasing mid range torque. And with quicker acceleration and vigorous passing power, it responds instantly to your demands.

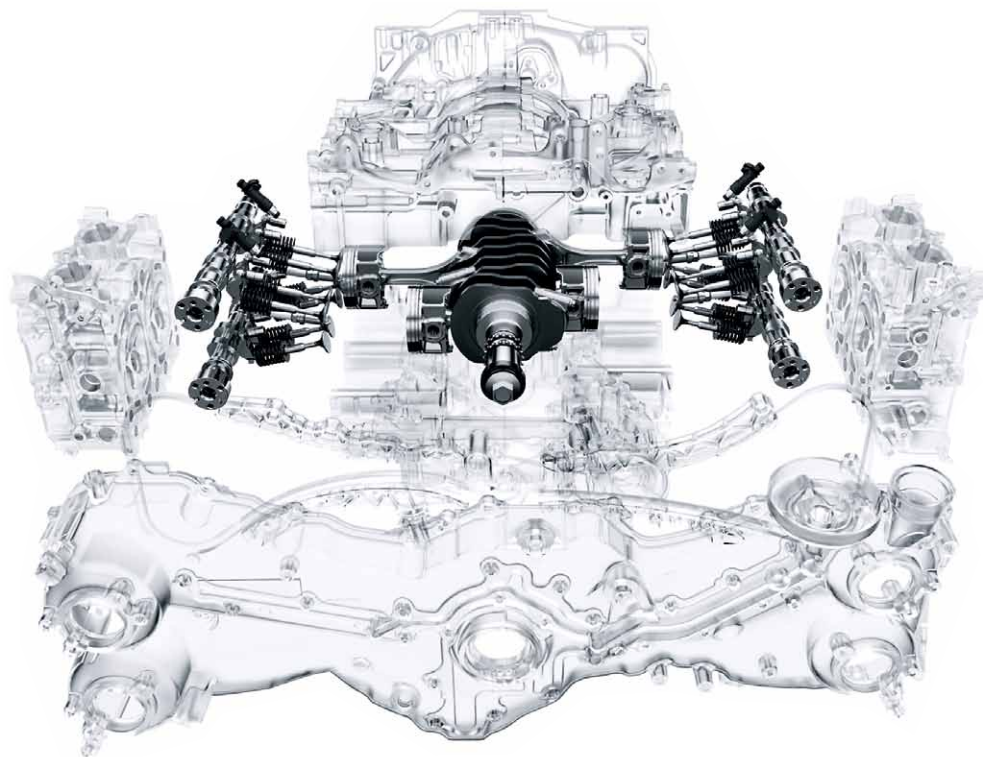

ALL 4 THE POWER

FORESTER S-EDITION: 2.5-LITRE FOUR-CYLINDER DOHC HIGH-POWER TURBOCHARGED BOXER ENGINE

Max. power: 193kW @ 6,000rpm
Max. torque: 347Nm @ 2,800–4,800rpm

The acclaimed sporty Subaru Boxer engine has been fine-tuned for the Forester S-EDITION. With a high-capacity intercooler and Dual Active Valve Control System (AVCS), it produces a swell of turbocharged power and a rich, flat torque curve. Invigorating acceleration and pure, sporty satisfaction are at the driver's command across the entire range of rpm.

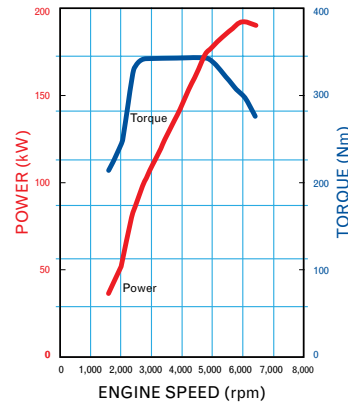

FORESTER X & FORESTER XS: NEW GENERATION 2.5-LITRE FOUR-CYLINDER DOHC BOXER ENGINE

Max. power: 126kW @ 5,800rpm
Max. torque: 235Nm @ 4,100rpm

Eager to rev yet easier on the earth, the new-generation 2.5-litre double overhead camshaft (DOHC) engine advances Subaru Boxer performance into a new era. Redesigned cylinder heads and its Active Valve Control System (AVCS) generate rewarding torque across the entire RPM range. Precise optimisation of its intake, fuel injectors, combustion chambers and cooling system minimise fuel consumption and emissions.

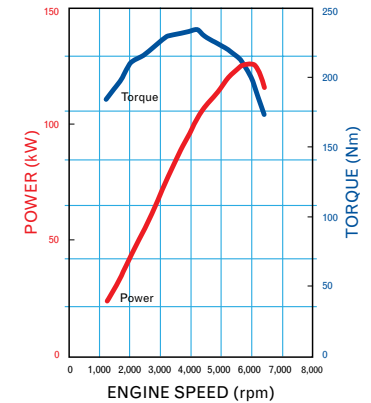

FORESTER XT: 2.5-LITRE FOUR-CYLINDER DOHC TURBOCHARGED BOXER ENGINE

Max. power: 169kW @ 5,200rpm
Max. torque: 320Nm @ 2,800rpm

This turbocharged DOHC 2.5-litre engine combines the immediate gratification of sports-car performance with the lasting pleasures of Subaru Boxer balance. A high-flow intercooler, Active Valve Control System (AVCS) and virtually no turbo lag generate a torrent of torque, a continuous crescendo of acceleration, and immeasurable fun.

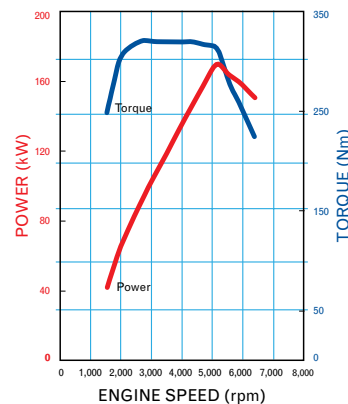

FORESTER DIESEL: 2.0-LITRE FOUR-CYLINDER DOHC TURBOCHARGED BOXER DIESEL ENGINE

Max. power: 108kW @ 3,600rpm
Max. torque: 350Nm @ 1,800-2,400rpm

Subaru's Boxer Diesel teams the inherent rigidity and smoothness of the Subaru Boxer engine design with advanced EURO5-compliant emission controls, responsive common-rail fuel injection and abundant low-end torque. Legendary fuel efficiency and durability come with performance that's unexpectedly quick and quiet.

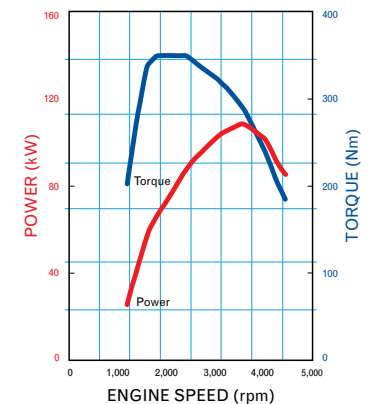

ALL 4 THE PERFORMANCE

Manual transmission

The five-speed manual transmission in the Forester X, Forester XS and Forester XT models is our smoothest yet – ensuring power delivery comes with an effortless touch of your hand. And in Forester X and Forester XS models, dual range selection allows you to easily go from 'high' to 'low' range for extra pulling power, enabling you to extend your adventure.

The six-speed manual transmission available in Forester 2.0D models has been specifically developed to deliver improved driveability, and a quieter, more fuel efficient ride.

The six-speed's wider gear ratio spread translates to faster acceleration in the lower gears, and improved fuel consumption – for an all-round stronger performance.



Six-speed manual transmission

Automatic transmission with manual mode

No two drives are the same. And the same goes for drivers. That's why the Forester's four-speed automatic transmission is actually three in one. This flexible transmission system gives you the option to choose the right driving mode for the particular conditions, and the way you want to drive. There's full automatic operation for everyday driving, Sport mode for a more exhilarating, responsive ride, as well as the driver-controlled manual mode that allows you to manually select your own gear – like a clutch-less manual gearbox.

And all automatic transmissions take advantage of 'Direct' electro-hydraulic control – which gives you greater responsiveness, and always-available pulling power



Four-speed automatic transmission

for those heavy loads. Plus the excellent shift quality of our automatic transmissions also ensures a smooth ride.

The Forester S-EDITION is equipped with a five-speed automatic transmission. It utilises a Variable Torque Distribution (VTD) centre differential that sets a drive split of 45 percent / 55 percent front to rear to ensure greater balance and control. The five-speed automatic transmission can be driven in full automatic mode or manual mode using the paddle gear shift on the steering column.



Forester S-EDITION instrumentation shown

WATCH THIS SPACE



Get in, and spread out. There's so much room in here. Not just for you, but for all your passengers, as well as loads of gear. The interior of the Forester has been specially designed to give everyone more leg room, and create a sense of space that makes every trip more comfortable.

It's versatile too. The front seats can easily be folded flat, and the

convenient one-touch 60/40 split folding rear seats feature a gentle recline function for extra comfort for those in the back. There's also lots of places to store knickknacks—with seat back pockets, a handy overhead sunglasses holder, and door pockets with bottle holders. And for those extra large loads, the wide-opening tail gate and low cargo floor mean it's even easier to get it all on board.

A place for everything

CDs, sunnies, mints – whatever it is, the Forester's multi-function centre console¹ makes it easier to put them away, and away from prying eyes. Plus the movable cup holder positions allow you to configure the console for a variety of purposes.

Connect more easily

The centre console also features an auxiliary jack and USB port or RCA jacks depending on the model for connecting MP3 players, as well as iPods² and other music devices, as well as a 12-volt power outlet that's perfect for charging your mobile phone.

Cards anyone?

In the Forester XS, Forester XT and Forester 2.0D models, the rear seat features a very clever retractable tray. All you have to do is turn over the centre seat cushion to reveal a subtle blue LED illuminated tray table with integrated double cup holder, so drinks are close to hand during those family car trips.



One-touch 60/40 split folding rear seat



Moulded door pockets with bottle holders



Rear seat console (Forester XS, Forester XT and Forester 2.0D models)



Centre front console¹ with auxiliary jack and USB port



Front centre console¹ with adjustable armrest



Front centre console¹

1. Available on the Forester X Automatic, Forester XS Automatic, Forester XT, Forester S-EDITION and Forester 2.0D models. 2. iPod is a registered trademark of Apple Computer Inc.



SAFETY FIRST SECOND AND THIRD

FIRST – BALANCE

Symmetrical All-Wheel Drive (SAWD) is an integral part of the Subaru driving experience. SAWD enhances control by taking advantage of the traction offered by all four tyres distributing power. Which means driving on low friction surfaces like wet or snowy roads and muddy tracks becomes much safer.

SECOND – STABILITY

All Foresters come standard with a high level of collision avoidance technologies – an electronic driver assist system called Vehicle Dynamics Control (VDC). This is not just Electronic Stability Control (ESC) but a complete system of safety measures.

Subaru's VDC system is made up of both stability and braking technologies:

- Electronic Stability Control (ESC)
- Traction Control System (TCS)
- TCS Limited Slip Device (LSD)
- Anti-Lock Braking System (ABS)
- Electronic Brakeforce Distribution (EBD)
- Brake Assist

So in extreme situations – like when you have to swerve or brake suddenly – VDC is there to help. The VDC system is constantly analysing through an array of sensors, the parameters that affect vehicle stability of the Forester whilst it's in motion.

Understeer or oversteer challenge even the best of drivers. The ESC technology incorporated within the VDC system aids the driver in maintaining control during cornering and emergency manoeuvres. When the road conditions are particularly challenging such as a muddy track the VDC Traction Control System and TCS Limited Slip Device kick in, minimising wheel spin and transferring power from the wheels that slip to the wheels with grip.

The Anti-lock Braking System (ABS) – including Electronic Brakeforce Distribution (EBD) and Brake Assist work together to help avoid wheels locking up, maximise stopping power and make sure the right amount of braking force is applied in an emergency. Every centimetre makes a difference. Put simply, all these features work together to give you control when you need it the most.

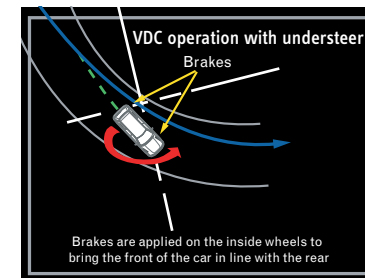
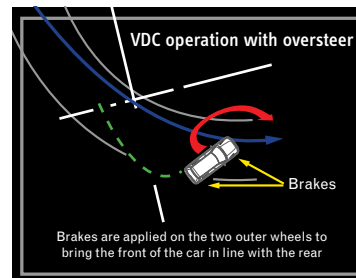
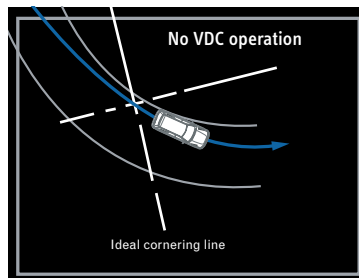

THIRD – PROTECTION

Five-star safety...

Every occupant can feel that much safer knowing the Forester has been awarded the maximum five-star crashworthiness rating for occupant safety from the respected and independent Australasian New Car Assessment Program (ANCAP)¹.

Such a high safety rating has a lot to do with the innovative advancements that we've made an integral part of the Forester. Things like the high-strength front seat frames and headrests that provide enhanced protection against whiplash in heavy rear-end collisions. All rear seatbelts come with Automatic Emergency Locking Retractors, and the front seatbelts feature pretensioners that are designed to hold you securely in place in an accident.

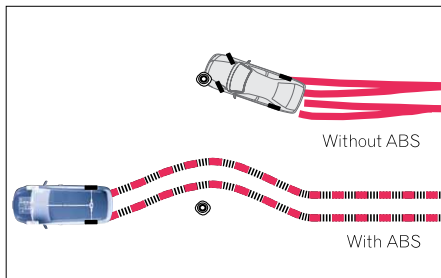

... That's tough on the outside...

The Forester's ring-shaped passenger safety cell is made to absorb impact – and features steel reinforcements, crumple zones and a strong, rigid build designed to help reduce injury in the event of an accident.



The chance of serious injury to the front occupants is further reduced by the ingenious positioning of the engine – low enough to slide below the cabin in a severe frontal collision. Plus the energy-absorbing collapsible steering column, and pedal intrusion limiting system help minimise driver injuries in a heavy frontal collision.

... And soft on the inside

Six SRS² airbags help protect passengers from a heavy impact. Dual front, front side and curtain airbags come standard in all Forester models.



A grand vision

Subaru design engineers take special care to optimise your field of vision from the driver's seat, without compromising the protection of all your occupants. The result is a strong passenger compartment, with outstanding visibility – helping you to avoid accidents in the first place.



Did you know?

All Subaru Forester models are fitted with advanced engine immobilisers and DataDot™ technology. Approximately 7,000 microscopic dots are laser-etched with your vehicle's unique Vehicle Identification Number – making your Subaru a much less attractive target for potential thieves. In fact, DataDot™ will even pay for your insurance excess should your new Subaru be stolen in the first year of ownership, if the vehicle is not recovered.

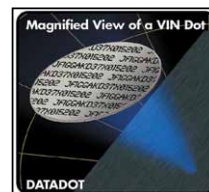

1. The Australasian New Car Assessment Program (ANCAP) gives consumers consistent information on the level of occupant protection provided by vehicles in serious front and side crashes.
 2. SRS: Supplemental Restraint System. Effective when used in conjunction with seatbelts.

ALL 4 THE ENTERTAINMENT

One of the most important elements of any road trip is getting the soundtrack right – and with the Forester every new place you see will be matched with something great to listen to.

Entertainment: Forester X and Forester 2.0D

With a four speaker audio entertainment system featuring an in-dash single CD player with an auxiliary jack and USB port that allow control of your MP3 player through the steering wheel buttons - giving you the best seats in the house with minimal distraction from the road ahead.

Bluetooth® wireless technology¹

Every Forester model features Bluetooth® wireless technology giving you hands-free calling from your mobile phone so you are always in touch.

Satellite navigation

Forester XT Premium and Forester S-EDITION feature a multi-information satellite navigation system, which puts every destination at your fingertips. Powered by the renowned Whereis™² Map database, it has been designed to not only be accurate, but intuitive too. To operate it, you simply have to touch the screen in the centre console, and you can easily toggle between a huge variety of map views.

1. Bluetooth® is a registered trademark of Bluetooth SIG Inc. System operation ability is subject to the Bluetooth® wireless technology specification of individual's phone.

2. Whereis is a registered trademark of Telstra Corporation Limited.

3. Information display and operation ability is subject to compatibility of the Bluetooth® audio device to AVRCP and some functions may be restricted.

4. Auxiliary jack and USB port not available when optional satellite navigation is fitted.

5. RCA jacks replace auxiliary jack and USB port when optional satellite navigation is fitted.

6. DVD only operates when vehicle is stationary.

Entertainment: Forester XS, Forester XS Premium, Forester XT and Forester 2.0D Premium

The premium audio entertainment system features six speakers including a subwoofer, plus an LCD³ screen that displays all your audio information, acts as a rear view reverse camera and lets you share your favourite pictures. An auxiliary jack⁴ and USB⁴ port allow control of your MP3 player through the steering wheel buttons, which means your favourite songs are only a touch away. Voice recognition also lets you make calls without taking your eyes off the road.

The impressive system features RCA jacks⁵, rear view reverse camera and a combined single CD/DVD⁶ player that presents sound and video in exceptional quality - it also incorporates dual trip meter functions as well as journey duration, distance and average fuel consumption. This multi-information satellite navigation system is also optional on Forester XS Premium and Forester 2.0D Premium models.



Single CD player with display



Satellite navigation system standard in the Forester XT Premium and Forester S-EDITION and optional on Forester XS Premium and Forester 2.0D Premium



ALL 4
THE FAMILY
THE WEEKENDS
THE FORESTER
RANGE





IMAGE: FORESTER S-EDITION

THE FORESTER RANGE

FORESTER S-EDITION



FORESTER X



Forester X black cloth interior shown

FORESTER XS



Forester XS grey cloth interior shown

FORESTER XS PREMIUM

Optional satellite navigation also available



Forester XS Premium black leather interior shown

THE FORESTER RANGE

FORESTER XT



Forester XT grey cloth interior shown

FORESTER XT PREMIUM



Forester XT Premium grey leather interior shown

THE FORESTER RANGE

FORESTER 2.0D



Forester 2.0D black cloth interior shown



FORESTER 2.0D PREMIUM

Optional satellite navigation also available



Forester 2.0D Premium grey leather interior shown



ALL 4 THE HUE THAT'S... YOU

One of the final choices – but one of the most important! The colour you choose for your Forester makes a bold statement about who you are.

So we've made sure you've got lots of ways to express yourself – with a wide range of colours to make your Forester more... you.



Note: Paint colours are representative only and subject to variation due to the printing process.

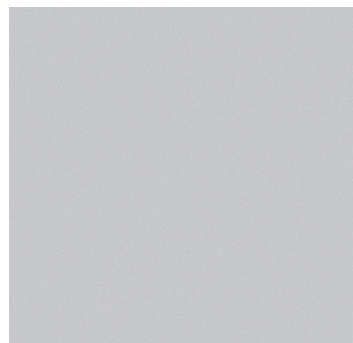

Spark silver metallic

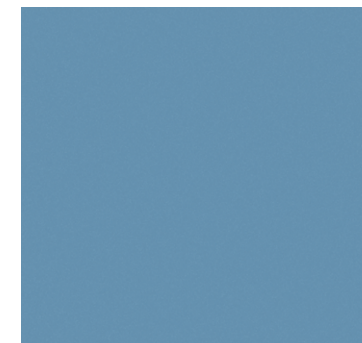

Sky blue metallic¹

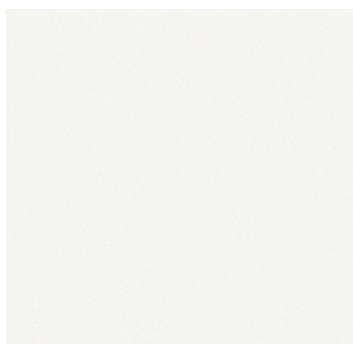

Satin white pearl

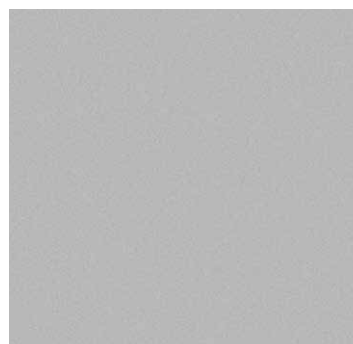

Steel silver metallic



Marine blue pearl¹

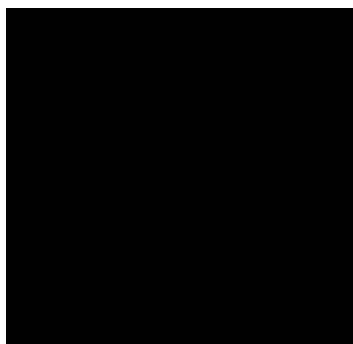

Obsidian black pearl



Dark grey metallic



Camellia red pearl

1. Not available on Forester XT or Forester S-EDITION models.



FORESTER
GET MORE DONE
HAVE MORE FUN

MAKE A GENUINE DIFFERENCE

Subaru Genuine Accessories

The small things can sometimes make the biggest difference. So to set your Subaru apart, personalise it with any of our Subaru Genuine Accessories. From the added protection of carpet mats and cargo trays, to towing and adventure packed roof carrying systems, we have a great range of accessories to help you get your Subaru just right for your lifestyle.

You can see the complete range of accessories at subaru.com.au

Genuine accessories. Genuine warranty

All Subaru Genuine Accessories come with a manufacturer's warranty:

- When you have them fitted at the time you purchase your new vehicle (or at your first scheduled service by your Subaru Retailer) you get a three-year/unlimited-kilometre warranty.

- When you purchase accessories and have them fitted by your Subaru Retailer any other time you get a two-year/unlimited-kilometre warranty.
- When you purchase accessories from your Subaru Retailer at any other time, you get 12-month/unlimited kilometre warranty.

You can get full warranty information at subaru.com.au



Roof cross bars



Atlantis 200 Luggage pod¹ - medium



Universal locking arm¹



Bicycle holder upright¹



Bonnet protector³



Headlight protector⁴



Door visor



Rear roof spoiler² (painting required)

1. Roof cross bars required. 2. Forester X and Forester XS models only. 3. Not suitable for Forester XT, Forester XT Premium, Forester S-EDITION, Forester 2.0D and Forester 2.0D Premium. 4. Not applicable for models with HID headlights.

ALL 4
THE LIFESTYLE
THE PERSONALISING
THE ACCESSORISING
THE FORESTER DRIVER



Forester XT Premium shown with roof cross bars and luggage pod



Mudflap set (front)



Cargo step panel (resin)



Cargo tray (low dish)



Rubber mat set



Tow bar



Bumper under guard front (silver)



Rear parking assistance system



Carpet mat set

ON THE ROAD TO TOMORROW



The maker of Subaru vehicles, Fuji Heavy Industries (FHI), understands the importance of environmental responsibility in all its business activities and services. And in keeping with its goal of being “an intelligent company that is friendly to the global environment” it’s constantly looking for ways to be more environmentally considerate – even in ways that reach beyond the automotive manufacturing sector of its business.

FHI has bettered its carbon dioxide emission reduction targets, thanks to their commitment to energy conserving programs at their factories and other facilities, including the introduction of natural gas-fuelled cogeneration facilities. It also strives to reduce CO₂ emissions in its non-automotive areas, producing fuel-efficient general use engines and wind turbine electric power generation systems.

And at the forefront of all this is their environmentally responsible manufacturing of Subaru vehicles, right across the world. For instance in North America, Subaru was the first automotive manufacturer to receive the stringent ISO 14001 environmental management standard. As well as being the first to achieve zero landfill status.

Since then, Subaru has achieved ISO 14001 accreditation across its entire Japanese business, and continues to find new ways to minimise its impact on the world we all call home.

(Source: Fuji Heavy Industries 2007 Social and Environmental Report)

SUBARU SERVICES

For more information about the Subaru Services listed below visit subaru.com.au

SUBARU FINANCE

Subaru Finance allows you to explore a range of tailored finance options through your authorised Subaru Retailer – so that approved customers can finalise purchase details quickly and conveniently. As dedicated automotive finance specialists, we can offer a range of private and business packages, including vehicle loans, leasing and commercial hire purchase finance.

SUBARU INSURANCE

We understand that you, as a Subaru owner, want a range of insurance options that offers features and benefits that complement your Subaru vehicle. Subaru Insurance options include:

- Subaru Comprehensive Motor Vehicle Insurance
- Subaru Motor Equity Insurance
- Subaru Loan Protection Insurance

These Subaru insurance products are available only through participating authorised Subaru Retailers.

SUBARU SME LEASING SOLUTIONS

Tailored specifically for small to medium businesses, Subaru SME Leasing Solutions allows your business to explore a range of operating lease solutions through your authorised Subaru Retailer, so that approved customers can enjoy the benefits a true fleet management company can provide. Subaru SME Leasing Solutions offers a range of business packages, including operating leasing and a full range of fleet management services.

SUBARU PREFERRED COLLISION REPAIRER NETWORK

Subaru has appointed a network of Preferred Collision Repairers, with stringent quality standards and high customer service levels. Our dedicated helpline is available on 1800 737 179, 24-hours a day, seven days a week.

SUBARU SERVICE AND SUBARU GENUINE CARE

Inherent within every Subaru is a philosophy of engineering excellence, award-winning performance and advanced driving technology. Subaru Genuine Care delivers the technical expertise, specialist diagnostic equipment and genuine replacement parts required to keep your Subaru in optimum condition. There is also the advantage of knowing your vehicle is maintained by factory-trained technicians with unequalled knowledge of Subaru products.

SUBARU LIFESTYLE

The philosophy of building motor vehicles that perform to the highest standards extends to our range of quality merchandise. With a diverse collection of stylish apparel and accessories, there is something to appeal to every Subaru enthusiast. To see the entire Subaru merchandise range, visit shop.subaru.com.au, or ask your local authorised Subaru Retailer.

SUBARU ROADSIDE ASSIST

In the unlikely event your Subaru breaks down or experiences technical problems, Subaru Roadside Assist is available 24-hours a day, seven days a week to help customers at a competitive annual fee starting from \$71.50*. For more information on Roadside Assist, ask your local authorised Subaru Retailer.

*Prices subject to change without notice.

SUBARU ASSURED WARRANTY PROGRAM FOR USED VEHICLES

Qualifying used Subaru vehicles from participating Subaru Assured Retailers offer a two-year unlimited kilometre warranty extension to further complement either the balance of a new vehicle or the statutory warranty that remains. Every used Subaru Assured vehicle must pass a 116-point inspection.

FORESTER AWARDS

2008 -

2010 • Australia's best selling compact SUV, VFACTS 2008, 2009, 2010

2009 • Best Compact SUV - Carsales Network People's Choice Award 2009, Subaru Forester

2008 • Best Compact SUV - Carsales Network People's Choice Award 2008, Subaru Forester
• People's Choice Award - Drive 2008, Subaru Forester
• Australasian New Car Assessment Program (ANCAP) five-star occupant safety rating for the entire Forester range
• International Engine of the Year Award, 2.0 – 2.5-litre class, Subaru Forester XT (2.5-litre turbocharged horizontally-opposed Boxer engine)

2006 • International Engine of the Year Award, 2.0 – 2.5-litre class, Subaru Forester XT (2.5-litre turbocharged horizontally-opposed Boxer engine)

2004 • Australasian New Car Assessment Program (ANCAP) five-star occupant safety rating for the entire Forester range
• Queensland Country Life, Queensland Country and Recreational Car of the Year, Subaru Forester XT

2003 • Australia's Best Cars, Best Recreational 4 Wheel Drive, Subaru Forester X
• Australasian New Car Assessment Program (ANCAP) five-star occupant safety rating for the Forester XS Luxury (the best-ever rating for a compact ATW)

2002 • Australia's Best Cars, Best Recreational 4-Wheel Drive, Subaru Forester X
• The Courier Mail, Queensland Car of the Year, Outstanding Recreational Vehicle, Subaru Forester X

2001 • Australia's Best Cars, Best Recreational Vehicle Under \$45,000, Subaru Forester Limited
• The Courier Mail, Queensland Car of the Year, Outstanding Recreational Vehicle, Subaru Forester

2000 • Australia's Best Cars, Best Recreational Vehicle, Subaru Forester
• 4x4 Australia, Best All-Wheel Drive, Subaru Forester
• The Courier Mail, Queensland Car of the Year, Outstanding Recreational Vehicle, Subaru Forester

1999 • RACT Best Cars, TAS, Best Recreational Vehicle & Overall Winner, Subaru Forester
• RACQ/The Courier Mail, QLD, Q-Car 1999, Best Recreational Vehicle & Overall Winner, Subaru Forester

subaru.com.au

Subaru (Aust) Pty Limited ABN 95 000 312 792 (Subaru Australia)
Level 3, 4 Burbank Place, Baulkham Hills NSW 2153. Toll Free: 1800 226 643

Subaru Australia reserves the right to vary vehicle specifications and standard features in Australia from those detailed in this brochure.

Vehicles shown in this brochure may be fitted with accessories available at additional cost.

No part of the brochure can be reproduced without written

permission from Subaru Australia. Printed in Australia.

© Copyright 2011 – Subaru (Aust) Pty Limited. All rights reserved.



ALL 4
THE RUNNING AROUND
THE FAMILY FUN
THE WEEKENDS
THE GETAWAY
THE FORESTER DRIVER



FORESTER | 2011

ALL 4 THE DRIVER™



SUBARU

MY11 FORESTER SPECIFICATIONS¹

MODEL		X	XS	XS Premium	XT	XT Premium	S-EDITION	2.0D	2.0D Premium	
TRANSMISSION										
5-speed manual transmission		•	•	•	•	•			•	
6-speed manual transmission									•	
4-speed automatic transmission with manual mode		•	•	•	•	•				
5-speed automatic transmission with manual mode							•			
ENGINE										
Engine type		Horizontally-opposed Boxer 4-cylinder, petrol engine			Turbocharged horizontally-opposed Boxer 4-cylinder, petrol engine			Turbocharged horizontally-opposed Boxer 4-cylinder, diesel engine		
Valve mechanism		DOHC with AVCS			DOHC with AVCS			DOHC		
Bore x stroke	mm	94.0 x 90.0			99.5 x 79.0			86.0 x 86.0		
Capacity	cc	2498			2457			1998		
Compression ratio		10			8.4			16.0		
Fuel tank capacity	litres	60			60			64		
Fuel system		Multi point sequential injection			Multi point sequential injection			Common rail direct injection		
Fuel requirement	RON	90-98			95 minimum			Diesel		
PERFORMANCE²										
Maximum power output (DIN)	kW/rpm	126kW@5800rpm			169kW@5200rpm			193kW@6000rpm		108kW@3600rpm
Maximum torque (DIN)	Nm/rpm	235Nm@4100rpm			320Nm@2800rpm			347Nm@2800-4800rpm		350Nm@1800-2400rpm
Maximum speed in top gear	km/h	198 (MT) / 185 (AT)			210 (MT) / 207 (AT)			228		186
Acceleration 0 - 100 km/h	seconds	9.2 (MT) / 10.2 (AT)			7.1 (MT) / 7.9 (AT)			6.5		10.4
Electronic Throttle Control system (ETC)					Drive-by-wire					
Fuel consumption (ADR81/02) ³	l/100km	9.3			10.5			6.4		
	urban	12.9 (MT) / 12.5 (AT)			14.4 (MT) / 14.5 (AT)			7.5		
	extra urban	7.2 (MT) / 7.5 (AT)			8.2			7.9		
	combined	7.2 (MT) / 7.5 (AT)			8.2			7.9		
C0 ₂ emissions (ADR81/02)	combined (g/km)	220			248			168		
Emission standards		EURO4			EURO4			EURO5		
SYMMETRICAL ALL-WHEEL DRIVE										
Type	Manual	Centre Differential with a Viscous Limited Slip Differential					n/a		Centre Differential with a Viscous Limited Slip Differential	
Type	Auto	Active Torque Split					Variable Torque Distribution		n/a	
TRANSMISSION										
Gear ratio	1st	3.454 (MT) / 2.785 (AT)			3.540			3.454		
	2nd	2.062 (MT) / 1.545 (AT)			1.947 (MT) / 1.545 (AT)			2.264		
	3rd	1.448 (MT) / 1.000 (AT)			1.366 (MT) / 1.000 (AT)			1.471		
	4th	1.088 (MT) / 0.694 (AT)			0.972 (MT) / 0.694 (AT)			1.000		
	5th	0.780 (MT)			0.738 (MT)			0.834		
	6th	n/a			n/a			0.557		
Gear ratio - reverse		3.333 (MT) / 2.272 (AT)			3.333 (MT) / 2.272 (AT)			2.370		
Final reduction gear ratio		4.111 (MT) / 4.444 (AT)			4.444 (MT) / 4.111 (AT)			3.272		
Dual range reduction ratio		1.196 (MT)			n/a			n/a		
STEERING										
Steering		Engine speed sensitive power assisted rack and pinion						Electric power steering		
Minimum turning circle (kerb to kerb)	m	10.5								
SUSPENSION										
Type	Front	McPherson strut type, independent suspension								
	Rear	Double wishbone type, independent suspension	Self-levelling double wishbone type, independent suspension				Double wishbone type, independent suspension	Self-levelling double wishbone type, independent suspension		
BRAKES										
Type	Front	Ventilated disc brake								
	Rear	Solid disc brake								
Brake booster type	mm	Tandem								
ABS		4-channel, 4-sensor ABS with Electronic Brakeforce Distribution								
WHEELS AND TYRES										
Tyre manufacturer		Bridgestone			Yokohama			Bridgestone		Yokohama
Tyres (width, profile, size, load index & speed rating)		215/65 R16 98H			225/55 R17 97V			215/65 R16 98H		225/55 R17 97V
Rim size		16x6.5JJ			17x7JJ			16x6.5JJ		17x7JJ
Wheels		16"			17"			16"		17"
Spare wheel		16"			17"			16"		17"
MEASUREMENT										
Overall length	mm	4560								
Overall width	mm	1795								
Overall height	mm	1700								
Wheel base	mm	2615								
Front track	mm	1530								
Rear track	mm	1530								
Minimum ground clearance ⁴	mm	220			225			215		
Cargo volume - rear seat up/down	litres	450/1660			450/1660			450/1660		
		450/1610			450/1610			450/1610		
Kerb weight ⁵	kg	1475 (MT) / 1490 (AT)	1480 (MT) / 1495 (AT)	1505 (MT) / 1520 (AT)	1510 (MT) / 1525 (AT)	1545 (MT) / 1560 (AT)	1585	1560	1595	
Tare mass	kg	1435 (MT) / 1450 (AT)	1440 (MT) / 1455 (AT)	1465 (MT) / 1480 (AT)	1470 (MT) / 1485 (AT)	1505 (MT) / 1520 (AT)	1545	1520	1555	
Seating capacity		5								
TOWING										
With trailer brakes	kg	1400			1600					
Without trailer brakes	kg				750					
Maximum tow ball down load	kg	140			160					

1. Subaru Australia reserves the right to change mechanical specification and equipment levels without notice. 2. All performance data measured using 95RON. 3. Fuel consumption figures calculated in accordance with Australian Design Rule 81/02. 4. Ground clearance at kerb weight. 5. Vehicle kerb weight varies according to the types of optional equipment included.

FORESTER AWARDS

2008 -

2010 • Australia's best selling compact SUV, VFACTS 2008, 2009, 2010

2009 • Best Compact SUV - Carsales Network People's Choice Award 2009, Subaru Forester

2008 • Best Compact SUV - Carsales Network People's Choice Award 2008, Subaru Forester
• People's Choice Award - Drive 2008, Subaru Forester
• Australasian New Car Assessment Program (ANCAP) five-star occupant safety rating for the entire Forester range
• International Engine of the Year Award, 2.0 – 2.5-litre class, Subaru Forester XT (2.5-litre turbocharged horizontally-opposed Boxer engine)

2006 • International Engine of the Year Award, 2.0 – 2.5-litre class, Subaru Forester XT (2.5-litre turbocharged horizontally-opposed Boxer engine)

2004 • Australasian New Car Assessment Program (ANCAP) five-star occupant safety rating for the entire Forester range
• Queensland Country Life, Queensland Country and Recreational Car of the Year, Subaru Forester XT

2003 • Australia's Best Cars, Best Recreational 4 Wheel Drive, Subaru Forester X
• Australasian New Car Assessment Program (ANCAP) five-star occupant safety rating for the Forester XS Luxury (the best-ever rating for a compact ATW)

2002 • Australia's Best Cars, Best Recreational 4-Wheel Drive, Subaru Forester X
• The Courier Mail, Queensland Car of the Year, Outstanding Recreational Vehicle, Subaru Forester X

2001 • Australia's Best Cars, Best Recreational Vehicle Under \$45,000, Subaru Forester Limited
• The Courier Mail, Queensland Car of the Year, Outstanding Recreational Vehicle, Subaru Forester

2000 • Australia's Best Cars, Best Recreational Vehicle, Subaru Forester
• 4x4 Australia, Best All-Wheel Drive, Subaru Forester
• The Courier Mail, Queensland Car of the Year, Outstanding Recreational Vehicle, Subaru Forester

1999 • RACT Best Cars, TAS, Best Recreational Vehicle & Overall Winner, Subaru Forester
• RACQ/The Courier Mail, QLD, Q-Car 1999, Best Recreational Vehicle & Overall Winner, Subaru Forester

subaru.com.au

Subaru (Aust) Pty Limited ABN 95 000 312 792 (Subaru Australia)

Level 3, 4 Burbank Place, Baulkham Hills NSW 2153. Toll Free: 1800 226 643

Subaru Australia reserves the right to vary vehicle specifications and standard features in Australia from those detailed in this brochure.

Vehicles shown in this brochure may be fitted with accessories available at additional cost.

No part of the brochure can be reproduced without written

permission from Subaru Australia. Printed in Australia.

© Copyright 2011 – Subaru (Aust) Pty Limited. All rights reserved.