



R8

 Audi Sport



Page	
Fascination	
4	Audi R18 e-tron quattro
6	Audi R8 LMS
8	Audi R8 V10 plus Coupé
22	Audi R8 V10 Coupé
Technology	
34	Innovations
36	Audi Sport
38	Performance
40	quattro®
42	Dynamics
44	Audi drive select
46	Laser light technology
48	Audi Space Frame (ASF®)
50	Manufacture
Equipment	
56	Audi exclusive
62	Style guides
64	Paint finishes
67	Sideblades
68	Wheels/tyres
70	Seats
72	Equipment packages
73	Headlinings
74	Inlays
76	Light
77	Design
78	Steering wheels/controls
79	Comfort
80	Infotainment
82	Assistance systems
82	Technology/safety
83	Audi Extended Warranty
Other	
84	Technical data
85	Dimensions
86	Index
92	The fascination of Audi

The equipment for the vehicles illustrated in the Fascination section can be found on page 91.

The fuel consumption and CO₂ emission figures can be found on page 84.

13 triumphs

Prove the ability to develop future technology through motorsport.

With numerous technical innovations, Audi has made motor racing history at the 24 Hours of Le Mans. Until now, the brand with the four rings has achieved thirteen wins in this toughest long-distance race in the world. Plus there was the distance record from 2010: 5,410.71 kilometres were covered in one race. In 2012 and 2013, Audi started at Le Mans with the R18 e-tron quattro and a completely new technology – the hybrid drive. And won at the first attempt. This racing car furthermore secured the world championship title at the FIA World Endurance Championship in 2012 and 2013. In 2014, Audi triumphed with the R18 e-tron quattro once again at Le Mans and also set a new best value with respect to efficiency. By using ultra technologies, an optimised hybrid system and a newly developed 4-litre V6 TDI engine, a decrease in the fuel consumption of 22 percent compared to the previous year was achieved. To date, 100 wins in long-distance racing series around the world can be attributed to the Audi Le Mans prototypes (LMP) R8, R10 TDI, R15 TDI, R18 TDI, R18 ultra and R18 e-tron quattro.

But the successes on the race track serve one core purpose: they are initiators for series innovations. Accordingly, you'll find more than quattro, TDI, TFSI and hybrid drive in Audi standard models. Our most recent innovations, such as LED headlights with matrix beam technology and the laser light that were tested on the race track in tough conditions, are there as well. Audi lightweight technologies provide the decisive split-second lead on the race track, and on the road they offer noticeably more driving dynamics, improved driving performance, lower consumption and lower emission values. The demonstration of what is possible in terms of technology pioneers the technologies you will find in many Audi standard vehicles.



269 wins in the genes

■ The new Audi R8 LMS.

The Audi R8 LMS succeeded in putting, the R8 on the race track: since 2009 the teams in over 1,050 races have won 26 national and international titles as well as 269 races in the GT3 sport. These include the 24-hour classics Nurburgring, Spa and Daytona. In total, the Audi R8 drivers have appeared on the podium 745 times. The successor to the Audi R8 LMS lives up to these triumphs that can be traced back to the R8 – with the best basic prerequisites:

The rear-wheel driven GT3 racing car deploys a power output of up to 430 kW* on the race track. Just like the vehicles competing in the DTM, aero-dynamic attachments provide for the necessary contact pressure. With the exception of the roof, all external attachments are made of carbon. Accordingly, the overall weight of the Audi R8 LMS has been reduced to only 1,225 kg*.

Around 50 percent of the vehicle parts are taken from the R8 V10 Coupé, including impressive technologies such as the Audi Space Frame (ASF®) and the V10 engine. The Audi R8 LMS thus combines standard series and racing technologies, and stands out in particular thanks to its high reliability and performance. An ideal basis for successful motorsport.

Audi race experience enables you to experience motor racing atmosphere first hand with the R8 LMS ultra: from individual training and acquiring a motorsport licence to participating in a race.

For further information, please visit www.audi-motorsport.com and www.audi.com/driving.

*Depending on the vehicle rating of the national motorsport authorities.
The fuel consumption and CO₂ emission figures can be found on page 84.



Focus **y**our power

The Audi R8 V10 plus Coupé & the Audi R8 V10 Coupé.

Two sports cars, one goal: moving the limits of feasibility. This is what they are geared towards. With all their power, but each in their own way. The new Audi R8 V10 plus Coupé will win you over with its performance and excellence. The new Audi R8 V10 Coupé also sets benchmarks. With its power, as well as its elegance. Experience it on the following pages – R8 after R8.

The fuel consumption and CO₂ emission figures can be found on page 84.



Audi R8 V10 plus Coupé

Performance to the extreme.

It was created in the world's most demanding development laboratory: motorsport. About 50 percent of all components that are used for the new R8 are based on motor racing technology. From the powerful engine and intelligent lightweight construction to the aerodynamic design: the R8 V10 plus Coupé proves that limits exist only to be exceeded.

The fuel consumption and CO₂ emission figures can be found on page 84.





330 km/h

■ **Prove that it has nothing to prove.**

The appearance of the new Audi R8 V10 plus Coupé makes its presence felt. Except when it comes to air resistance. The aero-dynamic body line is based on the shape of the legendary Audi R18. In addition, many details made of carbon, such as the new front spoiler, the exterior mirror housings, the two-piece sideblades, the rear wing and rear diffuser, which give it an unmistakable motor racing look. The 19-inch forged aluminium wheels and the 19-inch ceramic brake impressively draw attention to the R8 V10 plus Coupé even when stationary. As soon as the engine deploys its power and the fixed rear wing increases the downforce one thing becomes strikingly clear: this car is about more than just looks.

The fuel consumption and CO₂ emission figures can be found on page 84.

2 laser modules

**Create a face for progress.
A particularly striking one.**

The new Audi R8 V10 plus Coupé not only looks good – it has a personality. The striking Audi Singleframe with honeycomb grid in gloss anthracite grey and the wide air inlets testify to its boundless power. The LED headlights not only reflect excellence, the optional laser light is also very innovative. From speeds of 60 km/h, the four bundled high-power diodes are activated by the high-beam assist, creating a white light beam that outshines any LED headlight with its range and brightness. And makes progress highly visible – to the driver and to everybody else.

The fuel consumption and CO₂ emission figures can be found on page 84.



3.2 seconds

Are all it needs to turn a first impression into a lasting one.

The new Audi R8 V10 plus Coupé is setting benchmarks: the 5.2-litre V10-FSI engine has a power output of 449 kW and impresses with its breathtaking performance. It needs just 3.2 seconds to sprint from 0 to 100 km/h. Propulsion ends only at 330 km/h. The exterior is characterised by numerous carbon attachments, including the especially striking rear wing. It increases the downforce on the rear axle and enhances the overall athletic impression.

The fuel consumption and CO₂ emission figures can be found on page 84.





The image shows the driver's side of an Audi R8 V10 plus Coupé. The steering wheel is black with perforated leather and features the Audi logo and 'R8' branding. The dashboard is black with a large 12.3-inch TFT screen displaying the date '03.03.2015', a tachometer with 'R8' branding, and other information. The center console has a gear shifter and handbrake. The overall design is sleek and modern.

12.3 inches

**Revolutionise views.
Especially those of the driver.**

In the cockpit, everything is geared to what's essential: the driver. Engine start-up, driving dynamics, engine sound, infotainment or gear changing – all these functions can be controlled directly via the R8 performance leather steering wheel with four operating satellites. Without you having to take your hands off the contoured rim. The innovative Audi virtual cockpit also focuses on the driver. The 12.3-inch TFT screen brilliantly displays a lot of important information in high contrast. How content is displayed can be adjusted to meet your own personal wishes. So that you can have everything in view – with just one glance.

The fuel consumption and CO₂ emission figures can be found on page 84.

2 opponents of centrifugal force

■ The bucket seats in the new R8.

The cockpit of the new Audi R8 V10 plus Coupé meets the highest standards – only a few centimetres above the asphalt. The R8 bucket seats in classy fine Nappa leather in rotor grey embody premium craftsmanship and let driver and vehicle become one. With their heavily contoured bolsters and the integrated head restraints, the seats emphasise the motor racing character of the interior and provide excellent lateral support. For a driving experience that redefines sportiness.

The fuel consumption and CO₂ emission figures can be found on page 84.





Audi R8 V10 Coupé

■ The combination of power and elegance.

The new Audi R8 V10 Coupé is a clear statement. Whichever perspective you choose: its design language is unmistakable. Each line embodies pure aesthetics, yet leaves you in absolutely no doubt that this R8 is a high-performance sports car.

The fuel consumption and CO₂ emission figures can be found on page 84.

10 cylinders

 **Are at the centre of attention.**

Whoever sees the new Audi R8 V10 Coupé will want to drive it. Every line embodies timeless elegance and emphasises the unusual design: from the striking Audi Singleframe to the muscular side lines and athletic rear. The mid-engine is set like a jewel under the rear window and can even be illuminated on request. The central position of the engine results in a good vehicle balance and improved road handling. No matter whether you are driving along straight roads, round bends or at high speed – the new R8 V10 Coupé offers one thing above all: breathtaking driving enjoyment.

The fuel consumption and CO₂ emission figures can be found on page 84.



1,000 impressions

1 word: perfection.

It's not just the stylish exterior of the new Audi R8 V10 Coupé that's impressive. The sporty elegance, classy materials and precise workmanship of the interior are just as captivating. Every detail meets high demands. Both functional and aesthetic – such as the optional R8 sport seats in classy fine Nappa leather with diamond pattern. Choose from a total of 28 different colour combinations and set your very own tone in the cockpit. Because real style is defined by personality.

The fuel consumption and CO₂ emission figures can be found on page 84.



8,700 rpm

Bring its power to the fore. And to the asphalt.

The new Audi R8 V10 Coupé requires sensitivity- especially in your right foot. Just a brief touch of the gas pedal is sufficient for the 5.2-litre V10-FSI engine to harness its 397 kW of power and a maximum torque of 540 Nm to sprint from 0 to 100 km/h in just 3.5 seconds. The mid-engine design allows for a balanced weight distribution and thus higher speeds in bends. Also during gear-changing, the engine loses almost no propulsion: the 7-speed S tronic® enables lightning-fast gear changes with virtually no break in propulsive power. The permanent quattro all-wheel drive ensures high driving stability and power transmission.

The fuel consumption and CO₂ emission figures can be found on page 84.



Vorsprung durch Technik.

■ The innovations of Audi.

The world is constantly changing. Technology is advancing at an ever faster pace. And in the process, more and more opportunities are opening up to you – nowhere more so than in the field of mobility. We are playing an instrumental role in shaping this progress with Vorsprung durch Technik. Striving to provide you with technology that enriches your life. Making sure that we don't just satisfy your expectations of mobility both today and in the future, but continue to surpass them.



Technologies from **m** motor racing.

Transferred to **th**e road.

 Audi Sport.

Thrilling performance: whether it's works motorsport, customer racing or our high-performance models – you'll not get such a potent adrenalin rush anywhere else. Audi Sport utilises the expertise gained in motor racing to bring innovative technologies to series production. With unrivalled passion – for outstanding dynamism.





Maximum power. Put to maximum use.

■ The FSI® principle.

Consequently dynamic: the 5.2-litre V10 high-speed engine with dual injection reaches a power output of 449 kW. With a maximum torque of 560 Nm the R8 V10 plus Coupé accelerates from 0 to 100 km/h in just 3.2 seconds. Propulsion ends only at 330 km/h. The Audi R8 V10 Coupé brings a comparable performance to the road. With 397 kW and a maximum torque of 540 Nm, it sprints from 0 to 100 km/h in just 3.5 seconds. In addition, the deep installation position of the V10 engine and the cylinder angle of 90° provide the R8 with a low centre of gravity. An even oil supply is achieved in conjunction with the dry sump lubrication used in motorsport and you can enjoy the torque and agility in every bend even at high lateral acceleration forces.

The impressive combination of the inlet manifold and direct injection offers improved power delivery, low consumption and reduced exhaust emissions. And it complies with the strict guidelines of the EU6 emission standard. The engine runs even more efficiently with Audi cylinder on demand. Depending on the driving conditions in partial-load operation, the injection and ignition are switched off at a cylinder bank and only five, instead of ten, cylinders are active. Meanwhile the engine continues to run as quietly as ever and with improved consumption and emission values. Within milliseconds, the inactive cylinders can be switched on and the engine once again deploys its full power.

Engine: the S tronic 7-speed dual-clutch transmission combines the advantages of a conventional manual transmission with those of a modern automatic transmission. Setting benchmarks in terms of sportiness, comfort and efficiency. Using two permanently active transmission parts and by changing the power-transmitting clutch, gear changes are enabled in hundredths of a seconds and with virtually no break in propulsive power. The start-stop system and the coasting mode further help to improve efficiency.

The fuel consumption and CO₂ emission figures can be found on page 84.

Superb roadholding.

■ The quattro® permanent all-wheel drive.

Outstanding traction, improved handling dynamics and more driving safety – that is quattro. Hardly any other drive system around transfers the engine's power to the road so effortlessly. In the Audi R8 Coupé a newly developed quattro drivetrain is deployed. An electronically controlled and hydraulically operated multi-plate clutch at the front axle and a mechanical differential lock at the rear axle enable controlled and sporty driving behaviour while maintaining outstanding traction. What is special here is that the drive torque can be variably distributed between the front and rear axle as required. In addition, the wheel-selective torque control counteracts undesirable wheel slip through targeted braking actions on all wheels.

Depending on the weather and road conditions, it's possible to further modify the permanent all-wheel drive. Linking the quattro software and Audi drive select, R8 V10 plus Coupé drivers are able to use performance mode to adjust the drive characteristics to the route conditions. The R8 V10 Coupé can also be equipped with the performance mode.

The fuel consumption and CO₂ emission figures can be found on page 84.

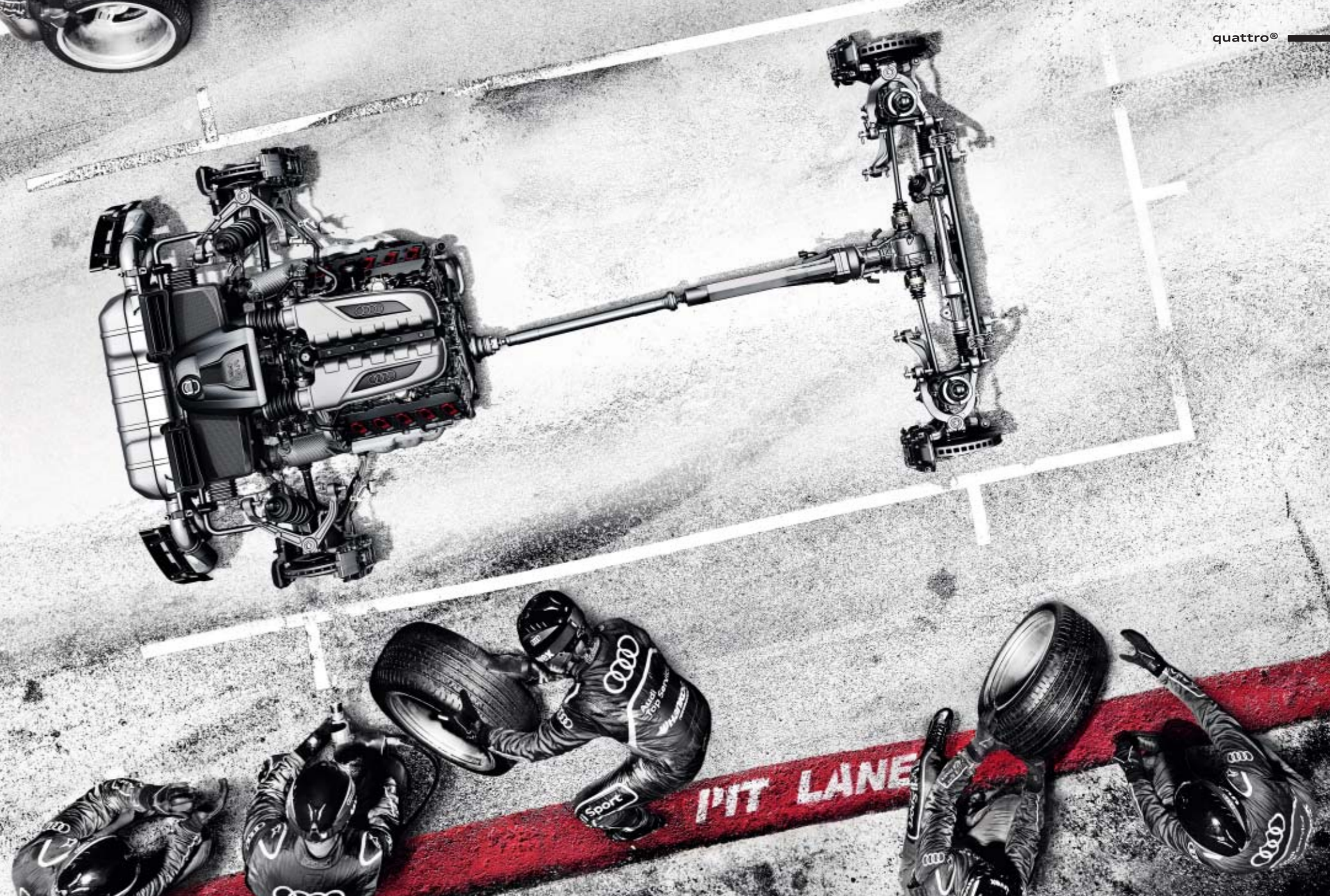

Bending the road to your will.

▀ Brake systems and suspensions.

Brake systems

Demonstrate power: with the standard 19-inch brake system in the Audi R8 V10 Coupé. The 8-piston fixed callipers at the front axle and the 4-piston fixed callipers at the rear axle take powerful hold at the wave brake discs. The cast friction rings have a wave-shaped outer contour and are connected to the aluminium brake disc chamber by means of steel pins. This so-called floating mounting ensures that the friction ring remains largely tension-free, and improves stability when subjected to high temperatures. Axial perforation and cooling channels for internal ventilation increase the performance of the brake discs. The intelligent mix of materials and the characteristic geometry of the friction rings allowed weight to be reduced, thus also improving the balance of the unsprung masses.

For even tougher requirements: the 19-inch ceramic brake system* at the front and rear – standard in the Audi R8 V10 plus Coupé. And optionally available for the Audi R8 V10 Coupé. The brake discs consist of carbon-fibre-reinforced ceramic material, a composite ceramic material made of hard silicon carbide. Even under high thermal stress their excellent deceleration and control are impressive. They also stand out thanks to their low weight. Moreover, the enormously firm and abrasion-resistant material increases the service life of the discs.

*Please consult your Audi partner or national Audi website to find out more about the special features of the ceramic brake.

Suspensions

Show character: with the sport suspension in the Audi R8 V10 Coupé you will experience sporty, as well as self-assured driving. A double-wishbone axle is used for the front and rear suspension. What's impressive about this construction that originated in motorsport is the resultant kinematics variance, highly precise wheel steering and excellent agility. The only way to achieve even more direct contact with the road and dynamic handling is with the stiffer spring/shock absorber combination of the Audi R8 V10 plus Coupé.

Audi magnetic ride is optionally available for individual suspension tuning. Depending on the selected mode, the damping forces are adjusted to the corresponding driving situation in fractions of a second. Thus achieving uncompromising driving behaviour and significantly more comfort and dynamism. The electromechanical power steering with RS-specific characteristic curve also increases the sportiness.

More control: a whole new generation of steering wheels appears for the first time in the Audi R8 Coupé. Depending on the model, it's possible to control the engine start, exhaust flaps, Audi drive select and the performance mode with a single hand movement – using the R8 sport leather steering wheel with multifunction plus and two operating satellites or the R8 performance leather steering wheel with multifunction plus and four operating satellites which is optionally available for the R8 V10 Coupé. On request, the optional performance mode provides for a plus in dynamism in the R8 V10 Coupé.

The fuel consumption and CO₂ emission figures can be found on page 84.



Reach your destination.

The way you want.

▀ Audi drive select.

Changing the character: with the standard Audi drive select in the Audi R8 V10 Coupé. Individual vehicle components can be influenced at the push of a button – including the engine, steering, permanent quattro all-wheel drive and the transmission. Four different modes are available for drivers to adjust the R8 to each corresponding driving condition: auto, comfort, dynamic and individual. Auto for superior sporty quality. Comfort for longer journeys. Dynamic for ambitious driving. And individual, so you configure the individual components according to your preferences.

Various optional systems can be configured, too. For example, the characteristic curves of the shock absorbers of the Audi magnetic ride. These can be varied in three stages: from balanced rolling in comfort mode through to sporty, direct responsiveness in the dynamic setting. The Audi R8 V10 plus Coupé is additionally equipped with the performance mode which is also optionally available for the R8 V10 Coupé. Thanks to the permanently assigned frictional coefficient parameters dry, wet and snow, drivers are able to actively adjust the R8 to the corresponding route conditions. For a plus in dynamism and safety.

The fuel consumption and CO₂ emission figures can be found on page 84.



See and **be** seen.

▀ Audi laser light.

An innovation with brilliance: the optional full-LED headlights with Audi laser light. The laser light technology is a revelation in lighting technology. It not only beams brighter than the conventional LED high beam, it also reaches twice as far. And provides more safety and comfort thanks to the increased range. From speeds of 60 km/h, four bundled high-power diodes with a wavelength of 450 Nm per headlight are used as the light source. The blue laser beams hit phosphor converter plates which transforms them into roadworthy white light. A reflector bundles the beams into an almost point-shaped source of light that focuses only on the car's own lane thanks to narrow side illumination, resulting in a significantly improved visual range that is bound to win you over. Blue ambient lighting and the front indicators with dynamic display – additional highlights of the R8 V10 Coupé – also allow for an unmistakable appearance.

The fuel consumption and CO₂ emission figures can be found on page 84.





Innovative lightweight construction.

■ Audi Space Frame (ASF®).

Vehicle body rigidity made easy: for over two decades, the Audi Space Frame has been a convincing example of innovative lightweight technology. The high-strength aluminium frame structure is characterised by a high level of rigidity while at the same time being lightweight. With the R8 V10 Coupé, Audi presents a new body concept and the next evolutionary step of the Audi Space Frame. The multi-material construction design takes centre stage. The body of the new Audi R8 V10 Coupé, for example, is made up of a variety of components: 50 % extruded aluminium sections, 15 % aluminium sheets and 21 % aluminium cast nodes. In addition to the well-known materials, new materials are being used in the Audi R8 V10 Coupé for the first time – such as the carbon elements that make up the final 14 %. This, in combination, with the higher-strength aluminium alloys and the struts concept in the rear of the car, allowed for a further increase in body rigidity and reduction in weight – while improving the functional characteristics at the same time. In addition, the geometric lightweight construction improved power transmission. That is because the Audi Space Frame represents not only safety, but also increased performance and sporty handling.

The fuel consumption and CO₂ emission figures can be found on page 84.

Hand-made precision.

▀ Audi manufacture.

Each Audi R8 is unique and bears its own personal style. Unlike in large-scale productions with fully automated processes, the R8 is mostly hand-made in the sports car manufacture of quattro GmbH. For example, the weld seams of the bodyshell are mainly manually created. Robots are used only for support for non-ergonomic production processes. Small, highly qualified teams give the sports car its unique shape and always comply with stringent Audi requirements – from assembling the body to putting on the finishing touches. After the body has been constructed, the most experienced employees assemble the R8 at 15 coordinated stations almost exclusively by hand. Due to the numerous equipment variants and customisation possibilities hardly any combination is created twice.

The fuel consumption and CO₂ emission figures can be found on page 84.

High-quality work down to the last detail.

■ Audi quality management.

The quality assurance engineers must meet the highest standards: their own. After completion, each car undergoes demanding quality control, because precision is a top priority at Audi. Each surface unevenness is detected. Even the slightest deviations from the most narrow clearance are noticed. Subsequently, each R8 is taken for a detailed road test drive which completes the comprehensive quality process. We have only one goal: to create an exceptional vehicle.

The fuel consumption and CO₂ emission figures can be found on page 84.





As unique **as** you are.

■ The equipment options.

Sportiness, comfort, design, functionality – whatever you demand of your Audi, it offers you a wealth of custom options. Audi equipment versions are varied and high-quality and you can tailor them entirely to your needs.

You have an exclusive character.

So why shouldn't your Audi have one too?

That the Audi exclusive range aspires to exclusivity is already evident from its name. Selected décors and coloured leather can be combined with customised paint finishes from the large selection of Audi exclusive colours to suit your own personal preferences. So you can highlight your car's exceptional character to even better advantage. Your Audi partner and the Audi exclusive Studio of the Audi Forum Neckarsulm await your wishes.





R8 V10 plus Coupé with Audi exclusive customised paint finish in Nardo grey, sideblades with Audi exclusive customised paint finish in solar orange and forged aluminium wheels in 10-spoke Y design in gloss anthracite black*
 The fuel consumption and CO₂ emission figures can be found on page 84. *Please note the special information relating to wheels on page 84.



Equipment: Audi exclusive full-leather upholstery and trim in perforated fine Nappa leather in jet grey/black, with contrasting stitching in orange, inlays in matt carbon and Audi exclusive seat backrest covers painted in solar orange



R8 V10 Coupé with Audi exclusive customised paint finish Santorin blue with pearl effect sideblades in oxygen silver and forged aluminium wheels in 5-twin-spoke design
The fuel consumption and CO₂ emission figures can be found on page 84.



Equipment: Audi exclusive full-leather upholstery and trim in fine Nappa leather in Havana brown/black, with contrasting stitching in black/Havana brown, inlays in Audi exclusive piano finish look, black

Character takes on many forms. Here are two of them.

What makes an Audi your Audi? Vehicle equipment entirely tailored to your needs. There are a wide range of options available to you to give your vehicle the exact touch you have in mind. More sportiness? More elegance? Let yourself be inspired.

Audi R8 V10 plus Coupé in Suzuka grey, metallic

Sideblades in gloss carbon

Exterior mirror housings in gloss carbon Audi exclusive

Forged aluminium wheels in 10-spoke Y design, gloss turned finish*

Fine Nappa full-leather upholstery and trim, express red with diamond pattern

Headlining in Alcantara, black with diamond pattern



Audi R8 V10 Coupé in camouflage green, metallic

Sideblades in kendo grey

Forged aluminium wheels in 5-twin-spoke design, in matt titanium look, gloss turned finish*

Fine Nappa full-leather upholstery and trim, parchment beige

Inlays in titanium paint finish, matt anthracite

Audi exclusive door sill trims with illuminated aluminium inlay

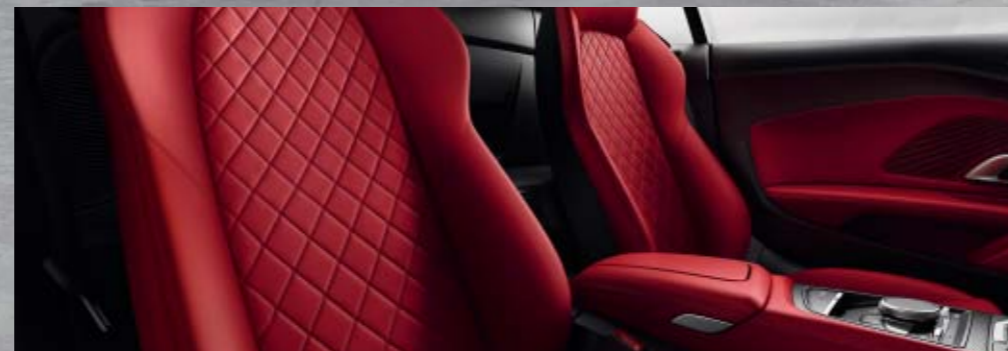

The fuel consumption and CO₂ emission figures can be found on page 84.

*Please note the special information relating to wheels on page 84.

Your Audi is painted not just once. But several times.

When you choose a paint colour, choose one that best reflects your own personality. Whichever colour you opt for, you can count on the outstanding quality of our painting process. Though no thicker than a human hair, the layer of paint on an Audi is actually made up of four different coats. And with a matt effect paint finish as many as six. To ensure that your Audi is optimally protected from environmental influences and wear. And also outwardly reflects your personality.



| Solid paint finishes



Ibis white



Dynamite red



Vegas yellow

| Metallic paint finishes



Suzuka grey, metallic

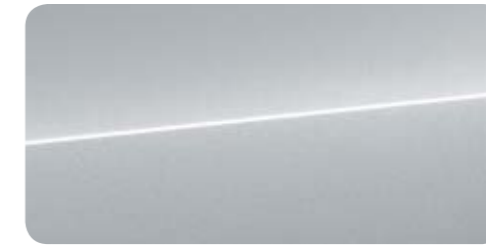

Floret silver, metallic



Tango red, metallic

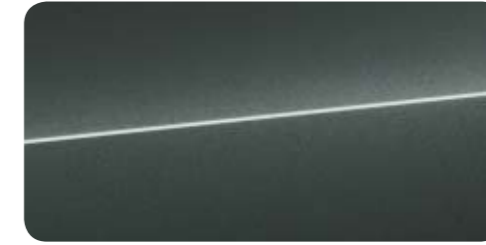

Camouflage green, metallic

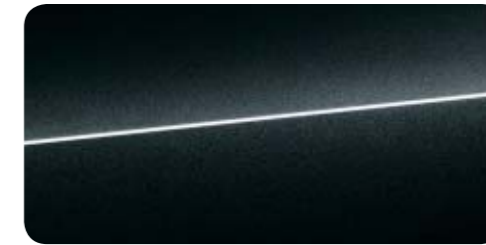

Mythos black, metallic

The model-specific standard and optional equipment can be found in the index from page 86 onwards.

| Pearl effect paint finish

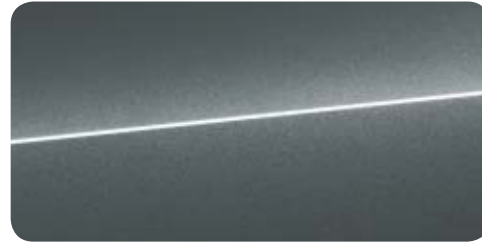

Daytona grey, pearl effect

| Crystal effect paint finish



Macaw blue, crystal effect

| Matt effect paint finish



Camouflage green, matt effect

| Audi exclusive



Audi exclusive customised paint finishes
Audi exclusive matt effect paint finishes*

| Sideblades

Sideblades can be chosen independent of exterior colour.

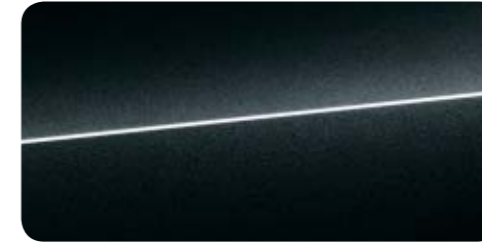

Mythos black, metallic



Oxygen silver



Gloss carbon



Kendo grey



Ice silver, metallic



Matt titanium grey



Audi exclusive customised paint finishes



The perfect connection between an Audi and the road: Audi wheels.

To make sure you have peace of mind for every metre of your drive, Audi puts its wheels through an exacting series of specialised test procedures. Hardness tests, for example, aim for maximum stability, while a copper accelerated salt spray test – CASS for short – using acetic acid guarantees the greatest possible corrosion protection. Thanks to these and many other measures, we can ensure that every Audi wheel offers maximum quality – even after scores of kilometres. No matter which of the numerous designs you choose.

The model-specific standard and optional equipment can be found in the index from page 86 onwards.

| Summer wheels



Cast aluminium wheels in 5-V-spoke design
size 8.5 J x 19 at the front and 11 J x 19 at the rear with 245/35 R 19 tyres¹ at the front and 295/35 R 19 tyres¹ at the rear



Forged aluminium wheels in 5-twin-spoke design
size 8.5 J x 19 at the front and 11 J x 19 at the rear with 245/35 R 19 tyres¹ at the front and 295/35 R 19 tyres¹ at the rear



Forged aluminium wheels in 10-spoke Y design, gloss turned finish³
size 8.5 J x 20 at the front and 11 J x 20 at the rear with 245/30 R 20 tyres¹ at the front and 305/30 R 20 tyres¹ at the rear



Cast aluminium winter wheels in 5-V-spoke design
size 8.5 J x 19 at the front and 10.5 J x 19 at the rear with 245/35 R 19 winter tyres¹ at the front and 295/35 R 19 winter tyres¹ at the rear, can be fitted with snow chains, permissible top speed 270 km/h

Sport tyres²: forged aluminium wheels in 10-spoke Y design, gloss turned finish³
optionally in matt titanium look, gloss turned finish³ or gloss anthracite black, size 8.5 J x 20 at the front and 11 J x 20 at the rear with 245/30 R 20 sport tyres at the front and 305/30 R 20 at the rear; additional set of tyres for improved grip in dry road conditions; approved for public traffic. Due to the adjustment of the tyres to dry road conditions, performance restrictions must be expected in wet conditions. The driving style must be adjusted accordingly.

Tyre pressure loss indicator
monitors the air pressure set in the tyres and the tyre temperature throughout the journey, also works with winter wheels delivered by Audi. Air pressures and temperatures of the individual wheels can be displayed in the Audi virtual cockpit.



Forged aluminium wheels in 5-twin-spoke design in matt titanium look, gloss turned finish³
size 8.5 J x 19 at the front and 11 J x 19 at the rear with 245/35 R 19 tyres¹ at the front and 295/35 R 19 tyres¹ at the rear



Forged aluminium wheels in 5-twin-spoke design in gloss anthracite black, gloss turned finish³
size 8.5 J x 19 at the front and 11 J x 19 at the rear with 245/35 R 19¹ tyres at the front and 295/35 R 19 tyres¹ at the rear



Forged aluminium wheels in 10-spoke Y design in matt titanium look, gloss turned finish³
size 8.5 J x 20 at the front and 11 J x 20 at the rear with 245/30 R 20 tyres¹ at the front and 305/30 R 20 tyres¹ at the rear



Forged aluminium wheels in 10-spoke Y design in gloss anthracite black
size 8.5 J x 20 at the front and 11 J x 20 at the rear with 245/30 R 20¹ tyres at the front and 305/30 R 20 tyres¹ at the rear



Forged aluminium winter wheels in 10-spoke Y design
size 8.5 J x 20 at the front and 11 J x 20 at the rear with 245/30 R 20 winter tyres¹ at the front and 295/30 R 20 winter tyres¹ at the rear, cannot be fitted with snow chains, permissible top speed 270 km/h

¹You will find specifications on the technical characteristics of tyres on page 91.

²For information on when this feature will be available, please contact your Audi partner.

³Please note the special information relating to wheels on page 84.

Premium quality you can rely on.

You have a special place in your Audi. Exclusivity can be felt on the seats: thanks to high-quality materials and first-class workmanship. No matter which seat upholstery you choose. Whether you prefer the R8 sport seats with shaped seat side bolsters or the R8 bucket seats with a more contoured seat shape: you're sitting in the right place.



R8 sport seats 1

The illustration shows R8 sport seat, partially electrically adjustable, in Alcantara/leather combination, black



R8 sport seats with diamond pattern¹ 2

The illustration shows R8 sport seat, electrically adjustable, in fine Nappa leather with diamond pattern in black



R8 bucket seats 3

The illustration shows R8 bucket seat, partially electrically adjustable, in perforated fine Nappa leather, black with coloured stitching in rock grey.

| Seat variants

- 1 R8 sport seats
- 2 R8 sport seats with diamond pattern¹
- 3 R8 bucket seats

| Leather



Alcantara/leather, black

1



Fine Nappa leather, express red

1 2



Fine Nappa leather, black

1 2

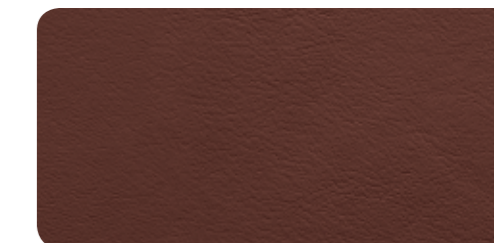

Fine Nappa leather, Vermont brown²

1 2



Fine Nappa leather, rotor grey

1 2



Fine Nappa leather, parchment beige²

1 2



Fine Nappa leather, black
with coloured stitching in dark silver¹

1 2



Fine Nappa leather, black
with coloured stitching in dynamite red¹

1 2

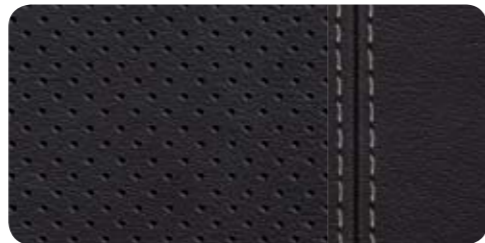

Fine Nappa leather, black, perforated
with coloured stitching in rock grey

3



Fine Nappa leather, black
with coloured stitching in macaw blue¹

1 2



Fine Nappa leather, black
with coloured stitching in express red¹

1 2



Fine Nappa leather, rotor grey, perforated
with coloured stitching in dark silver

3



Fine Nappa leather, black
with coloured stitching in condor grey¹

1 2



Fine Nappa leather, black
with coloured stitching in Vegas yellow¹

1 2



Audi exclusive leather upholstery and trim
Individual choice of colour for leather and stitching

1 2 3

| Seat variants

- 1 R8 sport seats
- 2 R8 sport seats with diamond pattern²
- 3 R8 bucket seats

| Leather upholstery and trim

Alcantara/leather combination

head restraints, backrest and seat side bolsters in leather; seat and backrest centre panel and door trim inserts in Alcantara

Fine Nappa leather upholstery and trim

seat upholstery including seat belt loops, scoop, monoposto, kneepad, upper part of centre console including armrest, armrests in doors and door pull handles, as well as the door trim inserts in leather

Fine Nappa full-leather upholstery and trim

the same as fine Nappa leather upholstery and trim; the following items are additionally in leather: dashboard, door rails, rear panel rails, side panel trims, steering wheel collapsible collar and lower part of centre console; with black seat upholstery: coloured stitching additionally available in dark silver, macaw blue, condor grey, dynamite red, express red or Vegas yellow

| Audi exclusive

Fine Nappa leather upholstery and trim with diamond pattern

seat upholstery including seat belt loops, scoop, monoposto, kneepad, upper part of centre console including armrest, armrests in the doors and door pull handles, as well as door trim inserts in leather; seat centre panels with diamond pattern in colour of seat upholstery; with black seat upholstery: coloured stitching additionally available in dark silver, macaw blue, condor grey, dynamite red, express red or Vegas yellow

Fine Nappa full-leather upholstery and trim with diamond pattern

the same as fine Nappa leather upholstery and trim with diamond pattern; the following items are additionally in leather: dashboard, door rails, rear panel rails and side panel trims, steering wheel collapsible collar, lower part of centre console; with black seat upholstery coloured stitching additionally available in dark silver, macaw blue, condor grey, dynamite red, express red or Vegas yellow

Coloured stitching for fine Nappa full-leather upholstery and trim¹

coloured stitching in the following equipment items: door trims, seats, armrest of centre console; available for full-leather upholstery and trim in black; coloured stitching available in dark silver, macaw blue, condor grey, dynamite red, express red or Vegas yellow

Audi exclusive leather upholstery and trim (package 1) in fine Nappa leather

seat upholstery including seat belt loops and head restraints, door trim inserts, armrests in the doors and door pull handles in leather. Individual choice of colour for the leather and the coloured stitching from the range of Audi exclusive colours.

Audi exclusive leather upholstery and trim (package 2) in fine Nappa leather

the same as Audi exclusive leather upholstery and trim (package 1) in fine Nappa leather; the following items are additionally in leather: kneepad, upper part of centre console including armrests. Individual choice of colour for the leather and the coloured stitching from the range of Audi exclusive colours.

Audi exclusive full-leather upholstery and trim in fine Nappa leather

the same as Audi exclusive leather upholstery and trim (package 2) in fine Nappa leather; the following items are additionally in leather: door rails, scoop, monoposto, lower part of centre console, upper and lower part of dashboard, and rear panel rails and side panel trims; upper part of dashboard available in the following leather colours: chestnut brown, saddle brown, smoky blue, night blue, jet grey, classic red, crimson red and Iceland green. Individual choice of colour for the leather and the coloured stitching from the range of Audi exclusive colours.

Audi exclusive full-leather upholstery and trim in fine Nappa leather with diamond pattern

the same as Audi exclusive leather upholstery and trim (package 2) in fine Nappa leather, with diamond pattern on the seat centre panel; the following items are additionally in leather: door rails, scoop, monoposto, lower part of centre console, upper and lower part of dashboard, and rear panel rails and side panel trims; upper part of dashboard available in the following leather colours: chestnut brown, saddle brown, smoky blue, night blue, jet grey, classic red, crimson red and Iceland green. Individual choice of colour for the leather and the coloured stitching from the range of Audi exclusive colours.

| Seat comfort

R8 sport seats

shaped seat side bolsters for better lateral support with integrated head restraints; with manual adjustment of fore/aft position; electric adjustment of seat height and backrest angle; folding backrests; optional package 1: additionally electric adjustment of fore/aft position, pneumatic adjustment of 4-way lumbar support (only in conjunction with leather upholstery and trim or full-leather upholstery and trim; optional package 2: the same functions as optional package 1 with pneumatic seat and backrest side bolster adjustment

R8 bucket seats

more contoured seat shape for increased lateral support, with integrated head restraints and R8 embossing in the backrests; with manual fore/aft adjustment and folding backrests, as well as electric seat height adjustment

Seat heating

heats seat and backrest centre panels and seat side bolsters; individually adjustable in several stages for driver and front-passenger side via a direct selection button on the air-conditioning controls

4-way lumbar support

pneumatically adjustable

| Headlinings

Headlining in cloth

depending on the interior equipment colour chosen, in black or lunar silver

Headlining in Alcantara

in black, lunar silver or parchment beige to match the selected interior colour; headlining, upper pillar trim and sun visors and in Alcantara

Headlining in Alcantara with diamond pattern

in black, lunar silver or parchment beige to match the selected interior colour; headlining, upper pillar trim and sun visors and in Alcantara; diamond pattern in matching colour

Audi exclusive headlining in Alcantara

Individual choice of colour for the Alcantara from the range of Audi exclusive colours.

Headlining in Alcantara with diamond pattern Audi exclusive

Individual choice of colour for the Alcantara and the diamond pattern from the range of Audi exclusive colours.

Experience fascination. Down to the last detail.

The exclusive Audi inlays emphasise the sporty ambience of your vehicle. At first sight. Be inspired by refined carbon, or paint finish for the monoposto, dashboard, centre console and door trims. High quality and precise workmanship harmoniously integrated in the interior.



The model-specific standard and optional equipment can be found in the index from page 86 onwards.

| Inlays



Adonised paint finish, anthracite

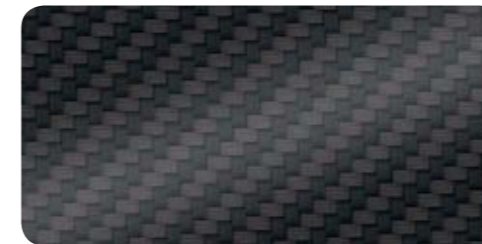

Matt carbon



Inlays painted in Audi exclusive colour*

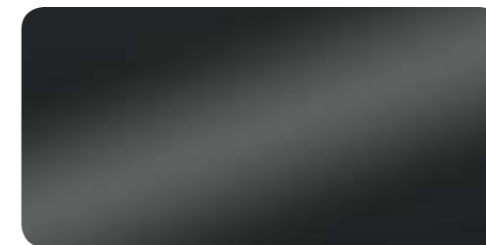

Titanium paint finish, matt anthracite



Audi exclusive piano finish look, black

Inlays

for clip on monoposto, inlays in the door and dashboard on the front-passenger side and in the centre console

Extended inlays in matt carbon

for surround of the Audi virtual cockpit and air vents

*For information on when this feature will be available, please contact your Audi partner.

| Headlights/interior lighting



LED headlights
with dipped beam, high beam, daytime running lights, indicator and static turning light in LED technology; enable a near daylight illumination of the road; minimum energy consumption, long service life and excellent recognition by other road users

High-beam assist

working within system limits, detects the headlights of oncoming traffic, the rear lights of other road users and light sources in built-up areas. Depending on the traffic situation, the high beam automatically adjusts to dipped beam and vice versa. The system thereby improves the driver's visibility and ensures a more relaxed drive thanks to the extra comfort and convenience.



LED headlights with Audi laser light*
with dipped beam, additional laser high beam, daytime running lights, indicators with dynamic display and static turning light in LED technology; minimum energy consumption, long service life and excellent recognition by other road users. The laser spot supplements the LED high beam as of a speed of 60 km/h and provide the driver a large plus of visibility and safety due to the high range. Additional blue LED ambient lighting and dynamic indicators. Segments of the LED light guides are illuminated in turn within milliseconds, creating a pulse of light that runs outwards in the direction the car is turning.



LED rear lights with dynamic indicators
brake, tail, indicator and reversing lights as well as number plate lights in LED technology; third brake light integrated above the rear window; with dynamic, clearly visible actuation of the indicators. The LED light guides are illuminated in turn within milliseconds, creating a pulse of light that runs outwards in the direction the car is turning.

Interior lighting

with delayed switch-off and contact switches on the doors; anti-glare lighting for the passenger compartment in energy-saving and long-lasting LED technology, comprising:

- interior lights including reading lights at front
- glove compartment lighting
- luggage compartment light
- lighting of inside door handles
- entrance light

lighting package

in addition to the interior lighting in LED technology:

- footwell lighting on the driver and front-passenger side
- lighting for door pockets
- ambient lighting underneath the switch panel in the centre console to help occupants better orient themselves
- engine compartment lighting

| Exterior design

Bumpers

in a sporty dynamic design; at the front with front spoiler in matt anthracite black and large air inlets in gloss anthracite black, at the rear with diffuser insert in matt anthracite black and air outlets in gloss anthracite black; for R8 V10 plus Coupé front spoiler and diffuser insert in gloss carbon



Rear wing

fixed rear wing in gloss carbon; for more downforce on the rear axle and even more sportiness

Light Design Steering wheels/controls Comfort Infotainment Assistance systems Technology/safety Audi Extended Warranty



Rear spoiler

can be extended electrically depending on speed; automatic extending at 120 km/h, retracting at 35 km/h; can also be operated manually using the button on switch panel in the centre console

Exterior package in Audi exclusive gloss carbon

Front spoiler and diffuser insert in gloss carbon



Engine compartment cover in gloss carbon

comprising air filter box cover and cover for the end wall and side parts left and right



Tank cap in aluminium

with R8 logo and electric locking; including tank inlet with capless system for refuelling without screw cap

Audi Singleframe V10 Coupé

radiator grille with honeycomb design in matt anthracite grey and with one-piece trim frame

Audi Singleframe V10 plus Coupé

radiator grille with honeycomb design in gloss anthracite grey and with one-piece trim frame

Model name/logo

model name R8 on the rear; V10 emblem on the side of the front hood

Side air outlet covers painted in Audi exclusive colour

cover of air outlets at the sides of the rear window painted in the colour of your choice

| Interior design



Door sill trims with aluminium inlays and R8 logo on the door sills



Audi exclusive door sill trims in matt carbon with illuminated aluminium inlay

including R8 logo on the door sills.

The inner edge of the aluminium inlay and the R8 logo are illuminated.

Audi exclusive door sill trims with illuminated aluminium inlay

including R8 logo on the door sills.

The inner edge of the aluminium inlay and the R8 logo are illuminated.

Audi exclusive personalised door sill trims

The aluminium inlay of the door sill trims can be customised with a logo. For more information, please contact your Audi partner.

Audi exclusive rear panel and parcel shelf in Alcantara

Individual choice of colour for the Alcantara from the range of Audi exclusive colours.

Audi exclusive carpet and floor mats*

Individual choice of colours for the carpet, rear panel trim, the floor mats, the leather piping and the stitching from the range of Audi exclusive colours.

Audi exclusive floor mats

Individual choice of colour for the floor mats, the leather piping and the stitching from the range of Audi exclusive colours.

Audi exclusive floor mats with R8 logo

in black with embroidery of the floor mats. Optionally leather piping and stitching in black or coloured. Individual choice of colour for the leather piping and the stitching from the range of Audi exclusive colours.

Audi exclusive luggage compartment lining in Alcantara*

Individual choice of colour for the Alcantara and the stitching from the range of Audi exclusive colours.

Audi exclusive sill trim in fine Nappa leather*

carpet border strips and bottom areas of the front post trim in leather. Individual choice of colour for the leather from the range of Audi exclusive colours.

Seat backrest covers painted in Audi exclusive colour*

for R8 bucket seats

| Steering wheels/controls



R8 sport leather steering wheel with multifunction plus and 2 operating satellites

in 3-spoke design, flattened at the bottom, with R8 emblem and shift paddles; to control Audi drive select and engine start-stop function, as well as the Audi virtual cockpit and available infotainment features; adjustable in height and reach, with full-size airbag

Audi exclusive leather controls

steering wheel rim, selector lever knob and gaiter in leather. Individual choice of colour for the leather and the stitching from the range of Audi exclusive colours. Stitching on the steering wheel rim with specific Audi exclusive seam detail

Audi exclusive controls in black suede

steering wheel rim and selector lever knob in black suede. Individual choice of colour for the stitching from the range of Audi exclusive colours. Stitching on the steering wheel rim with specific Audi exclusive seam detail



R8 performance leather steering wheel with multifunction plus and 4 operating satellites

in 3-spoke design, flattened at the bottom, with R8 emblem, grip areas with cover in perforated leather, shift paddles with application in aluminium look; to control Audi drive select and engine start-stop function, performance mode, exhaust flap control, as well as the Audi virtual cockpit and available infotainment features; adjustable in height and reach, with full-size airbag

| Mirrors

Exterior mirrors with integrated LED indicators electrically adjustable and heated; convex, flat or aspherical mirror glass

also optionally:

electrically folding and automatically dimming on both sides, including automatic kerb-side function for exterior mirror on the passenger side

The automatic kerb-side function tilts the exterior mirror on the passenger side downwards when reverse gear is selected, giving the driver a better view of the kerb.

Exterior mirror housings

optionally:

painted in body colour

in Audi exclusive gloss carbon

| Glazing

Heat-insulating glass

green tinted, windscreen made of laminated glass

Light Design Steering wheels/controls Comfort Infotainment Assistance systems Technology/safety Audi Extended Warranty

| Climate control



Deluxe automatic air conditioning

in special R8 look, with sunlight-dependent control; electronically regulates the air temperature, air flow rate and air distribution; ram air control and recirculation mode, flow-through ventilation; defroster vents for windscreen and side windows, footwell air vents; activated carbon filter

| Closing systems

Convenience key

access authorisation system, where the vehicle key only needs to be carried with you; the engine is started and switched off via the engine start-stop button on the steering wheel, the vehicle is unlocked and locked from outside via sensors on all door handles

Garage door opener (HomeLink)

programmable radio-operated remote control, control buttons integrated in the interior light module; can be used to open and/or close garage doors and exterior gates; can be used to control security and lighting systems. (For information on compatible handheld transmitters, please contact your Audi partner or visit www.eurohomelink.com.)

Anti-theft alarm

including interior monitoring system and tow-away protection via angle of inclination sensors; can be switched off; signal horn for monitoring doors, bonnet and engine compartment lid independent of vehicle electrical system: prevents doors being opened from the inside as soon as the vehicle has been locked via the radio-operated remote control

Preparation for tracking system

preparation for connecting a tracking system (available from Audi Genuine Accessories) that enables a stolen vehicle to be located and tracked

| Storage/transport

Storage package

storage net behind the seats and nets at the side in the luggage compartment

| MMI®/navigation

MMI® navigation plus with MMI touch

- navigation system¹ integrated in the 12.3" Audi virtual cockpit
- Map update²: download of current navigation data³
- 3D map representation with display of lots of sightseeing information and city models
- MMI search: free text search with intelligent destination suggestions during entry
- MMI touch for rapid, intuitive operation – e.g. destination entry using handwriting recognition function as well as ability to move and zoom freely on the map
- detailed route information: map preview, choice of alternative routes, POIs, lane recommendations, motorway exits, detailed junction maps, etc.
- dynamic route guidance with TMCpro (in conjunction with Audi connect: traffic information online⁴)
- vehicle support based on navigation data and speed limit display
- country information, e.g. on valid speed limits, motorway sticker requirement when crossing a border, etc.
- myAudi special destinations: import of individual point-of-interest (POI) lists to the vehicle via SD card and myAudi portal
- voice control system enables operation by means of whole-word entry of address in 1 sentence
- control in natural language
- MMI radio
- access to smartphone voice control
- flash memory for music (10 GB)
- AUX-IN + Audi music interface (2 USB ports + charging function)
- DVD drive (MP3, WMA, AAC and MPEG-4 compatible) for music CDs and video DVDs
- 2 SD card readers
- Bluetooth interface



Audi virtual cockpit

innovative, fully digital instrument cluster for the flexible display of information tailored to the driver's needs such as: vehicle speed/engine speed, map representation, Audi connect services, radio/media information, etc.; integration of the full MMI functionalities in the instrument cluster. The VIEW button on the multifunction steering wheel allows you to change between 2 differently sized representations of the round instruments. The display with small instruments allows the onboard computer and MMI contents to be shown on a large clear area of the display. The Audi virtual cockpit is operated via the R8 sport leather steering wheel or the R8 performance leather steering wheel and the MMI control panel or MMI touch. Display of navigation map as 3D terrain model on the high-resolution 12.3" colour display; configuration of onboard computer values in the rev counter is possible; permanent display of navigation information near the speedometer when route guidance has been activated; including attention assist

| Radio systems

Audi music interface

for the connection of portable medial players⁵ via USB interface (including charging function) or Wi-Fi; convenient navigation through the music collection with the aid of the MMI control panel, R8 sport leather steering wheel or R8 performance leather steering wheel or voice command

Audi sound system

impressive sound thanks to 5-channel amplifier with a total output of 140 watts and 5 loudspeakers including centre speaker



Bang & Olufsen Sound System

fascinating Surround Sound reproduction thanks to 16-channel amplifier with 13 high-performance loudspeakers including centre speaker, 2 bass speakers in the doors and subwoofer in the passenger footwell with a total output of 550 watts; including loudspeaker covers with aluminium applications and LED accent lighting

Digital Audio Broadcasting

in addition to the range of analogue stations, reception of digitally broadcast radio stations⁶ according to DAB standard, including DAB+ and DMB audio; display of information accompanying the programme (e. g. artist, title, depending on provision by the respective radio station) as well as additional information in the form of a slide show (e. g. cover, weather); a 2nd DAB tuner continuously searches for alternative reception frequencies of the set radio station; at the same time the station list is updated

| Communication

Audi phone box⁷

allows phone calls to be made in the vehicle with improved reception quality by placing the mobile phone in the compartment in the front centre console; hands-free facility and voice control (telephone); low SAR radiation in the interior by connecting to the external aerial; can be operated via MMI or the R8 sport leather steering wheel or R8 performance leather steering wheel; charging facility via USB port

Bluetooth interface

allows hands-free calls to be made in the vehicle using the microphone and – depending on mobile phone compatibility⁷ – Bluetooth audio streaming. Bluetooth-compatible mobile phones can be connected to the vehicle via the interface.

Audi connect

convenient connection of your vehicle to the internet for the use of Audi connect via an integrated data module with LTE⁸/UMTS support. There is a reader for your SIM card in the surround of the MMI navigation plus with MMI touch.

The following services supported by Audi connect are currently available in your model:

Mobility & navigation

- point-of-interest (POI) search with voice control
- traffic information online⁹
- navigation with Google Earth™¹⁰ and Google Street View™¹⁰
- destination entry via myAudi or Google Maps™¹⁰
- flight information
- bus and train information
- fuel prices
- parking information

Communication

- Wi-Fi hotspot
- access to Facebook
- access to Twitter

Infotainment

- online media streaming¹¹
- weather
- news online (individual)
- travel information

In conjunction with the optionally available equipment Audi phone box, Audi connect includes a car phone function via SIM card slot or rSAP profile.

Use of the services supported by Audi connect is possible only with the optional Audi connect equipment. You also require a SIM card with data option and with LTE option⁸ to use LTE. The services are available only in conjunction with an existing or separate mobile phone contract and only within the range of the respective the mobile phone network. Additional costs may be incurred when receiving data packets from the internet, depending on the terms of your mobile phone contract, particularly when used abroad. Because of the high data volumes involved, a data flat rate is strongly recommended.

The availability of the services supported by Audi connect varies from country to country. The Audi connect services are provided for at least 1 year from vehicle delivery. Following a period of 24 months, Audi connect services are extended once free of charge for 12 months. If you do not require this free extension, please write to:

AUDI AG
Customer Support Germany
D-85045 Ingolstadt
Email: kundenbetreuung@audi.de
Tel.: +49 (0) 800-2834 7378423

The city events, bus, train and flight information service and further services are available to the customer for 12 months. Ask your Audi partner about a subsequent extension of the Audi connect services.

Depending on the vehicle model, Audi connect enables access to Facebook and Twitter services. Permanent availability cannot be guaranteed as this is the responsibility of Facebook and Twitter.

Please visit www.audi.com/connect or contact your Audi partner for more detailed information about Audi connect; contact your mobile services provider for information about contract conditions.

¹The navigation data for supported countries is stored on the integrated memory. For more information, please contact your Audi partner. ²The map version delivered can be updated with the first 5 updates issued at intervals of six months. The current navigation data can be downloaded from the myAudi platform at www.audi.com/myaudi and installed via SD card in the vehicle. The update can also take place in the vehicle in conjunction with Audi connect. In addition, it is possible to have the new navigation data installed by an Audi partner at extra cost. ³Navigation data for many countries are stored on the SD card or hard drive. For more information, please contact your Audi partner. ⁴The Audi connect service traffic information online is available for many countries. For more information, please contact your Audi partner. ⁵Please contact your Audi partner or visit www.audi.com/mp3 for information on compatible media players. ⁶Reception depends on digital network availability. ⁷Please contact your Audi partner or visit www.audi.com/bluetooth for information on compatible mobile phones. ⁸For information about the availability and use of LTE support, please contact your Audi partner. ⁹The Audi connect service traffic information online is available for many countries. For more information, please contact your Audi partner. ¹⁰Google and the Google logo are registered trademarks of Google Inc. ¹¹Depending on country-specific availability. You will generally need an account with a media streaming provider to be able to use the service; this will result in additional costs.

| Assistance systems

Parking system plus¹

makes parking easier within system limits by indicating acoustically how far away the vehicle is from an object detected in front and behind the vehicle; measurement by ultrasonic sensors integrated discreetly in the bumpers. Display in the Audi virtual cockpit; activated when reverse gear is selected or via the button on the centre console

Parking system plus with reversing camera¹

image of area behind the vehicle shown in the Audi virtual cockpit, with dynamic display modes showing the path calculated based on steering angle; auxiliary lines and guidelines as well as representation of the point at which to apply opposite lock when parallel parking; supports comfortable entry and exit of parking spaces; reversing camera integrated discreetly in the rear end part; activated when reverse gear is selected or via button on the centre console

Cruise control¹

At speeds from around 30 km/h, the system keeps the set speed constant provided that engine power and engine braking effect permit it; operated via separate steering column stalk, set speed displayed in the Audi virtual cockpit; including settable speed limiter

| Driving dynamics/brakes

Electromechanical power steering

combines precision and comfort with especially energy-saving technology. The electromechanical steering system ensures stability at high speeds whilst also being light and precise when parking and manoeuvring.

Dynamic steering

enhances the driving dynamics and driving comfort thanks to more direct steering characteristics (e. g. on winding country roads or when turning) and reduced steering effort (e. g. when parking and manoeuvring); impressive driving characteristics thanks to a steering ratio based on the steering angle and speed-sensitive steering assistance

R8 sport suspension

with dynamically tuned spring/shock absorber combination; on R8 V10 plus Coupé with stiffer spring-shock absorber combination for more direct contact with the road and sportier handling

Audi magnetic ride

improves ride comfort and driving dynamics by regulating the damping forces based on the driving situation; adaptive damper system with 3 suspension settings (auto/comfort/dynamic); operated via Audi drive select



Ceramic brake²

6-piston fixed-calliper brake at front, 4-piston fixed-calliper brake at rear, brake discs made of carbon fibre reinforced ceramic with specially developed cooling channels, ventilated, perforated and with floating mounting; brake callipers at front and rear painted in gloss anthracite, with “Audi ceramic” logo

Brake system

8-piston fixed-calliper brakes at front, 4-piston fixed-calliper brakes at rear; wave brake discs at front and rear ventilated, perforated and with floating mounting; brake callipers painted in gloss black, with R8 logo

Brake callipers, painted in gloss red

for brake system with wave brake discs, with R8 logo front and rear



Performance mode

part of the R8 performance leather steering wheel with multifunction plus and 4 operating satellites with 3 additional setting options (dry, wet and snow) for improved driving dynamics and even more sportiness; can be set directly via the R8 performance leather steering wheel with multifunction and 4 operating satellites

Audi drive select

features different modes – auto, comfort, dynamic and individual – that allow you to change the vehicle’s individual characteristics by adapting the engine and gear-change characteristics, power steering assistance, exhaust flap control and the settings of optional equipment

| Technology/safety

Electronic Stabilisation Control (ESC)

with sport mode, can be deactivated in 2 stages; with hydraulic brake assist and emergency braking display; improves stability in hazardous situations by targeted braking of individual wheels and intervention in the engine management system

Recuperation

economises on fuel through brake energy recovery; kinetic energy is converted into usable electrical energy by increasing the generator voltage when the vehicle is coasting or braking and relieving the generator during subsequent acceleration

Start-stop system

helps to reduce fuel consumption and CO₂ emissions by automatically switching off the engine when stationary, e.g. at traffic lights. The start process is initiated as soon as the foot brake is released. Can be deactivated via a switch in the centre console at any time

Light Design Steering wheels/controls Comfort Infotainment Assistance systems Technology/safety Audi Extended Warranty



S tronic®

The 7-speed dual-clutch transmission with electrohydraulic actuation allows faster gear changing with virtually no perceptible break in propulsive power. The S tronic can be manually operated using the shift paddles behind the steering wheel or via the selector lever. In automatic mode, choose from programmes D (Drive) and S (Sport). Includes hill hold assist

When in “D” gear, coasting mode allows an anticipatory driving style and helps to reduce fuel consumption by automatically disengaging when the accelerator is released. It is automatically re-engaged when the footbrake or the accelerator is pressed. Can be activated in Audi drive select comfort mode

Exhaust system

dual-branch design with chrome-plated trapezoidal tailpipe trims. On V10 plus Coupé in gloss black

Sport exhaust system

dual-branch design with gloss black trapezoidal tailpipe trims; for an increased sound experience

Audi cylinder on demand

Depending on the driving conditions in partial-load operation, the injection and ignition are switched off at a cylinder bank and only 5, instead of 10, cylinders are active. Whilst the engine continues to run as quietly as ever and with improved consumption and emission values. Within milliseconds, the inactive cylinders can be switched on and the engine deploys its full power once again.

quattro®

permanent all-wheel drive with passive differential lock on the rear axle as well as wheel-selective torque control and electronically controlled multi-plate clutch on the front axle; distribution of drive forces depending on the driving situation to each individual wheel for precisely controlled, sporty handling; influence on torque distribution in conjunction with Audi drive select; with quattro emblem in the Audi Singleframe

Audi Space Frame (ASF®) body

high-strength aluminium/carbon-frame structure with high level of stiffness for improved driving dynamics and greater driving stability

| Audi Extended Warranty

Audi Extended Warranty

The Audi Extended Warranty provides extended risk cover and cost control beyond the first 2 years of the manufacturer’s warranty for a variety of claims. It can be ordered directly and only on purchase of a new car. Choose from 9 combinations of service life and mileage. For more information, please contact your Audi partner.

¹ Please note: The systems work only within system limits. They assist the driver with driving tasks. However, the driver remains responsible for driving the vehicle and is required to be attentive.

² Please consult your Audi partner or national Audi website to find out more about the special features of the ceramic brake.

Model	R8 V10 plus Coupé	R8 V10 Coupé
Engine type	V10-cylinder petrol engine with combined inlet manifold and direct fuel injection	V10-cylinder petrol engine with combined inlet manifold and direct fuel injection
Displacement in cc (valves per cylinder)	5,204 (4)	5,204 (4)
Max. output ¹ in kW at rpm	449/8,250	397/8,250
Max. torque in Nm at rpm	560/6,500	540/6,500
Power transmission/weight		
Drive type	quattro® permanent all-wheel drive	quattro® permanent all-wheel drive
Transmission type	7-speed S tronic	7-speed S tronic
Unladen weight ² (EU) in kg	1,630	1,670
Gross vehicle weight in kg	1,895	1,895
Fuel tank capacity, approx. in l	73	83
Performance/consumption³		
Top speed in km/h	330	320
Acceleration 0–100 km/h in s	3.2	3.5
Fuel grade	Sulphur-free SuperPlus 98 RON ⁴	Sulphur-free SuperPlus 98 RON ⁴
Fuel consumption ⁵ in l/100 km	urban: 17.5 extra-urban: 9.3 combined: 12.3	urban: 16.7 extra-urban: 8.4 combined: 11.4
CO ₂ emission ⁵ in g/km	urban: 408 extra-urban: 219 combined: 287	urban: 394 extra-urban: 200 combined: 272
Emission standard	EU6	EU6

Explanatory notes

¹ The figure given was calculated using the specified measuring procedure (current version of UN-R-85).

² Unladen vehicle weight includes driver (75 kg) and fuel tank 90 % full, calculated in accordance with the current version of Reg. (EU) 1230/2012. Optional equipment may increase the vehicle's unladen weight and drag coefficient, whereupon the possible payload limit and the top speed will be reduced accordingly.

³ A vehicle's fuel consumption and CO₂ emissions as well as deviations from the given values do not just depend on how efficiently the vehicle uses the fuel, but are also influenced by driving behaviour and other non-technical factors. CO₂ is the greenhouse gas primarily responsible for global warming.

⁴ We recommend using sulphur-free SuperPlus unleaded RON 98 fuel complying with DIN EN 228. If this is not available, use sulphur-free super unleaded RON 95 fuel in accordance with DIN EN 228; power output will be slightly reduced. Unleaded RON 95 fuel with a maximum ethanol content of 10 % (E10) can generally be used. Fuel consumption details refer to operation with RON 95 fuel complying with 692/2008/EC.

⁵ The figures given were calculated using the specified measuring procedures. The figures do not refer to one individual vehicle and do not form part of any offer, but rather should be used purely for purposes of comparison between the different vehicle models.

Important information

Special information about the wheels: Wheels with gloss turned finish as well as polished and partly polished aluminium wheels must not be used in wintry road conditions. For manufacturing reasons, the rim surface does not have sufficient corrosion protection for such use and can be damaged permanently by road salt or similar.

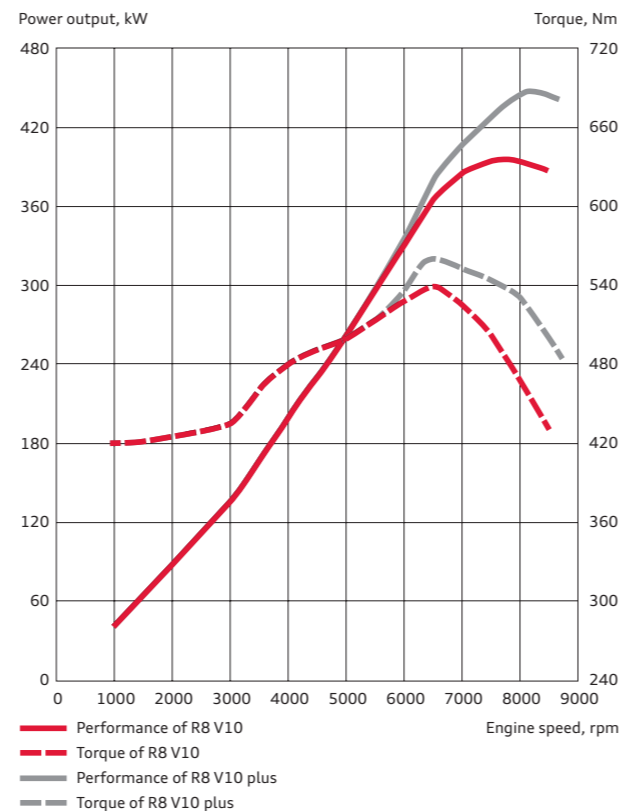
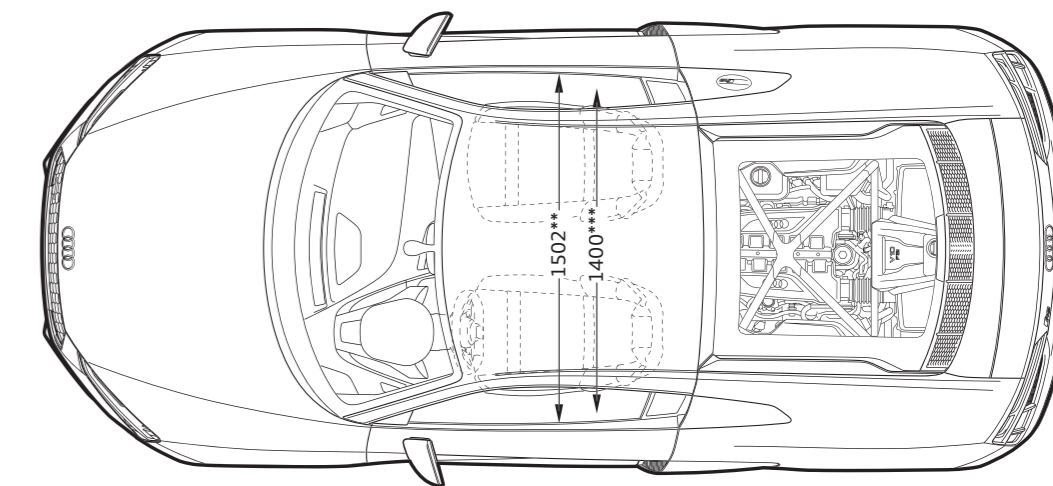
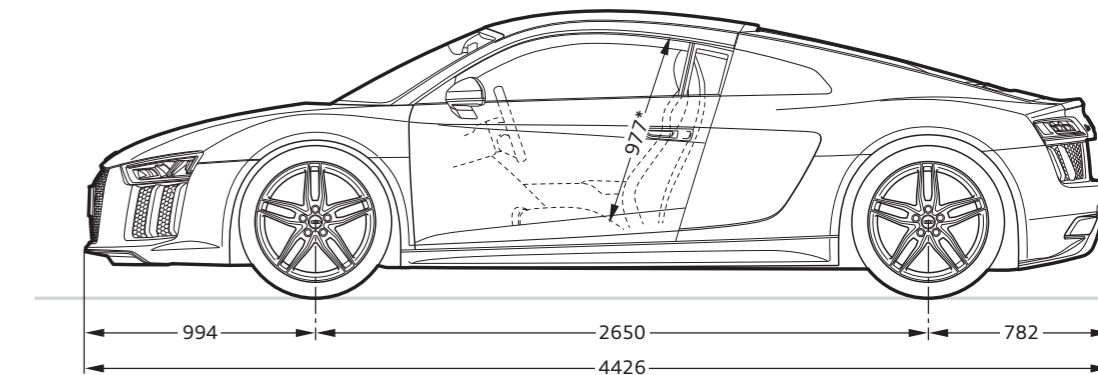
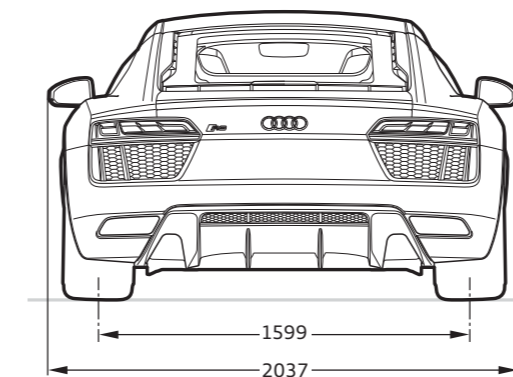
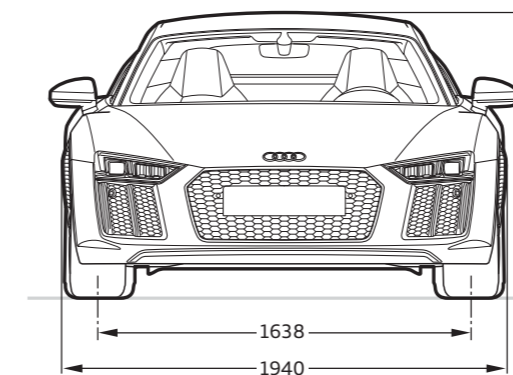













**Audi R8 V10 Coupé****Dimensions in millimetres.**



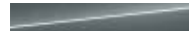







Dimensions were measured with vehicle at unladen weight.









Luggage compartment volume in l: 112 (additional luggage compartment behind the driver and front-passenger seat in l: 226).







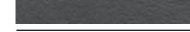



Turning circle approx. 11.2 m.

*Maximum headroom. **Elbow room width. ***Shoulder room width.

	Page	R8 V10 Coupé	R8 V10 plus Coupé
Solid paint finishes	65		
 Ibis white		<input type="checkbox"/>	<input type="checkbox"/>
 Dynamite red		<input type="checkbox"/>	<input type="checkbox"/>
 Vegas yellow		<input checked="" type="checkbox"/>	<input checked="" type="checkbox"/>
Metallic paint finishes	65		
 Suzuka grey, metallic		<input checked="" type="checkbox"/>	<input checked="" type="checkbox"/>
 Floret silver, metallic		<input checked="" type="checkbox"/>	<input checked="" type="checkbox"/>
 Tango red, metallic		<input checked="" type="checkbox"/>	<input checked="" type="checkbox"/>
 Camouflage green, metallic		<input checked="" type="checkbox"/>	<input checked="" type="checkbox"/>
 Mythos black, metallic		<input checked="" type="checkbox"/>	<input checked="" type="checkbox"/>
Pearl effect paint finish	66		
 Daytona grey, pearl effect		<input checked="" type="checkbox"/>	<input checked="" type="checkbox"/>
Crystal effect paint finish	66		
 Macaw blue, crystal effect		<input checked="" type="checkbox"/>	<input checked="" type="checkbox"/>
Matt paint finish	66		
 Camouflage green, matt effect		<input type="checkbox"/>	<input checked="" type="checkbox"/>
Customised paint finishes	66		
 Audi exclusive customised paint finishes		<input checked="" type="checkbox"/>	<input checked="" type="checkbox"/>
Audi exclusive matt effect paint finishes ¹		<input checked="" type="checkbox"/>	<input checked="" type="checkbox"/>
Sideblades	67		
 Sideblades in kendo grey		<input checked="" type="checkbox"/>	<input checked="" type="checkbox"/>
 Sideblades in mythos black, metallic		<input checked="" type="checkbox"/>	<input checked="" type="checkbox"/>

 Sideblades in ice silver, metallic		<input type="checkbox"/>	<input checked="" type="checkbox"/>
 Sideblades in oxygen silver		<input checked="" type="checkbox"/>	<input checked="" type="checkbox"/>
 Sideblades in matt titanium grey		<input checked="" type="checkbox"/>	<input checked="" type="checkbox"/>
 Sideblades in gloss carbon		<input checked="" type="checkbox"/>	<input type="checkbox"/>
 Sideblades in Audi exclusive customised paint finishes		<input checked="" type="checkbox"/>	<input checked="" type="checkbox"/>
Wheels/tyres	69		
 19" cast aluminium wheels in 5-V-spoke design		<input type="checkbox"/>	<input type="checkbox"/>
 19" forged aluminium wheels in 5-twin-spoke design		<input checked="" type="checkbox"/>	<input checked="" type="checkbox"/>
 19" forged aluminium wheels in 5-twin-spoke design, in matt titanium look, gloss turned finish ²		<input checked="" type="checkbox"/>	<input type="checkbox"/>
 19" forged aluminium wheels in 5-twin-spoke design, in gloss anthracite black, gloss turned finish ²		<input checked="" type="checkbox"/>	<input checked="" type="checkbox"/>
 20" forged aluminium wheels in 10-spoke Y design, gloss turned finish ²		<input checked="" type="checkbox"/>	<input checked="" type="checkbox"/>

 20" forged aluminium wheels in 10-spoke Y design in matt titanium look, gloss turned finish ²		<input checked="" type="checkbox"/>	<input checked="" type="checkbox"/>
 20" forged aluminium wheels in 10-spoke Y design in gloss anthracite black		<input checked="" type="checkbox"/>	<input checked="" type="checkbox"/>
 19" cast aluminium winter wheels in 5-V-spoke design		<input checked="" type="checkbox"/>	<input checked="" type="checkbox"/>
 20" forged aluminium winter wheels in 10-spoke Y design		<input checked="" type="checkbox"/>	<input checked="" type="checkbox"/>
Sport tyres		<input checked="" type="checkbox"/>	<input checked="" type="checkbox"/>
Tyre pressure loss indicator		<input type="checkbox"/>	<input type="checkbox"/>
Tyre repair kit		<input type="checkbox"/>	<input type="checkbox"/>
Anti-theft wheel bolts		<input type="checkbox"/>	<input type="checkbox"/>
Vehicle tool kit		<input type="checkbox"/>	<input type="checkbox"/>
Seat upholstery	71		
 Alcantara/leather, black		<input type="checkbox"/>	<input checked="" type="checkbox"/>
 Fine Nappa leather, black		<input checked="" type="checkbox"/>	<input checked="" type="checkbox"/>
 Fine Nappa leather, rotor grey		<input checked="" type="checkbox"/>	<input checked="" type="checkbox"/>
 Fine Nappa leather, express red		<input checked="" type="checkbox"/>	<input checked="" type="checkbox"/>







 Fine Nappa leather, Vermont brown		<input checked="" type="checkbox"/>	<input checked="" type="checkbox"/>
 Fine Nappa leather, parchment beige		<input checked="" type="checkbox"/>	<input checked="" type="checkbox"/>
 Fine Nappa leather, black, with coloured stitching in dark silver		<input checked="" type="checkbox"/>	<input checked="" type="checkbox"/>
 Fine Nappa leather, black, with coloured stitching in macaw blue		<input checked="" type="checkbox"/>	<input checked="" type="checkbox"/>
 Fine Nappa leather, black, with coloured stitching in condor grey		<input checked="" type="checkbox"/>	<input checked="" type="checkbox"/>
 Fine Nappa leather, black, with coloured stitching in dynamite red		<input checked="" type="checkbox"/>	<input checked="" type="checkbox"/>
 Fine Nappa leather, black, with coloured stitching in express red		<input checked="" type="checkbox"/>	<input checked="" type="checkbox"/>
 Fine Nappa leather, black, with coloured stitching in Vegas yellow		<input checked="" type="checkbox"/>	<input checked="" type="checkbox"/>
 Fine Nappa leather, black, perforated, with coloured stitching in rock grey		<input checked="" type="checkbox"/>	<input type="checkbox"/>
 Fine Nappa leather in rotor grey, perforated, with coloured stitching in dark silver		<input checked="" type="checkbox"/>	<input type="checkbox"/>
 Audi exclusive leather upholstery and trim		<input checked="" type="checkbox"/>	<input checked="" type="checkbox"/>
Leather upholstery and trim	72		
Alcantara/leather combination		<input type="checkbox"/>	<input checked="" type="checkbox"/>
Fine Nappa leather upholstery and trim		<input checked="" type="checkbox"/>	<input type="checkbox"/>
Fine Nappa full-leather upholstery and trim		<input checked="" type="checkbox"/>	<input checked="" type="checkbox"/>
Fine Nappa leather upholstery and trim with diamond pattern		<input checked="" type="checkbox"/>	<input checked="" type="checkbox"/>
Fine Nappa full-leather upholstery and trim with diamond pattern		<input checked="" type="checkbox"/>	<input checked="" type="checkbox"/>
Coloured stitching for fine Nappa full-leather upholstery and trim		<input checked="" type="checkbox"/>	<input checked="" type="checkbox"/>
Audi exclusive leather upholstery and trim (package 1) in fine Nappa leather		<input checked="" type="checkbox"/>	<input checked="" type="checkbox"/>
Audi exclusive leather upholstery and trim (package 2) in fine Nappa leather		<input checked="" type="checkbox"/>	<input checked="" type="checkbox"/>
Audi exclusive full-leather upholstery and trim in fine Nappa leather		<input checked="" type="checkbox"/>	<input checked="" type="checkbox"/>
Audi exclusive full-leather upholstery and trim in fine Nappa leather with diamond pattern		<input checked="" type="checkbox"/>	<input checked="" type="checkbox"/>

Standard equipment Optional equipment Not available

Country-specific variations possible. Please find out from your local Audi partner which equipment is standard and what optional equipment is available in your country.

More detailed descriptions of a selection of items from the equipment range can be found from page 54 onwards.

¹ For information on when this feature will be available, please contact your Audi partner. ² Please note the special information relating to wheels on page 84.

	Page	R8 V10 Coupé	R8 V10 plus Coupé
Seat comfort	73		
R8 sport seats		<input type="checkbox"/>	<input checked="" type="checkbox"/>
R8 bucket seats		<input checked="" type="checkbox"/>	<input type="checkbox"/>
Seat heating		<input type="checkbox"/>	<input type="checkbox"/>
4-way lumbar support		<input checked="" type="checkbox"/>	<input checked="" type="checkbox"/>
Seats, partially electrically adjustable		<input type="checkbox"/>	<input type="checkbox"/>
Seats, electrically adjustable (optional package 1)		<input checked="" type="checkbox"/>	<input checked="" type="checkbox"/>
Seats, electrically and pneumatically adjustable (optional package 2)		<input checked="" type="checkbox"/>	<input checked="" type="checkbox"/>
Head restraints		<input type="checkbox"/>	<input type="checkbox"/>
Headlinings	73		
Headlining in cloth		<input type="checkbox"/>	<input type="checkbox"/>
Headlining in Alcantara		<input checked="" type="checkbox"/>	<input checked="" type="checkbox"/>
Headlining in Alcantara with diamond pattern		<input checked="" type="checkbox"/>	<input checked="" type="checkbox"/>
Audi exclusive headlining in Alcantara		<input checked="" type="checkbox"/>	<input checked="" type="checkbox"/>
Audi exclusive headlining in Alcantara with diamond pattern		<input checked="" type="checkbox"/>	<input checked="" type="checkbox"/>
Inlays	75		
 Adonised paint finish, anthracite		<input type="checkbox"/>	<input checked="" type="checkbox"/>
 Titanium paint finish, matt anthracite		<input checked="" type="checkbox"/>	<input checked="" type="checkbox"/>
 Matt carbon		<input checked="" type="checkbox"/>	<input type="checkbox"/>
 Audi exclusive piano finish look, black		<input checked="" type="checkbox"/>	<input checked="" type="checkbox"/>
 Inlays painted in Audi exclusive colour¹		<input checked="" type="checkbox"/>	<input checked="" type="checkbox"/>
 Extended inlays in matt carbon		<input checked="" type="checkbox"/>	<input checked="" type="checkbox"/>

	Page	R8 V10 Coupé	R8 V10 plus Coupé
Headlights/light	76		
LED headlights		<input type="checkbox"/>	<input type="checkbox"/>
LED headlights with Audi laser light² and dynamic indicators		<input checked="" type="checkbox"/>	<input checked="" type="checkbox"/>
Light and rain sensor		<input type="checkbox"/>	<input type="checkbox"/>
High-beam assist		<input checked="" type="checkbox"/>	<input checked="" type="checkbox"/>
LED rear lights with dynamic indicators		<input type="checkbox"/>	<input type="checkbox"/>
Rear fog light		<input type="checkbox"/>	<input type="checkbox"/>
Interior lighting		<input type="checkbox"/>	<input type="checkbox"/>
Lighting package		<input checked="" type="checkbox"/>	<input checked="" type="checkbox"/>
Exterior design	77		
Bumpers		<input type="checkbox"/>	<input type="checkbox"/>
Rear wing		–	<input type="checkbox"/>
Rear spoiler		<input type="checkbox"/>	–
Exterior package in Audi exclusive gloss carbon		<input checked="" type="checkbox"/>	<input type="checkbox"/>
Engine compartment cover in gloss carbon		<input checked="" type="checkbox"/>	<input checked="" type="checkbox"/>
Tank cap in aluminium		<input type="checkbox"/>	<input type="checkbox"/>
Audi Singleframe V10 Coupé		<input type="checkbox"/>	–
Audi Singleframe V10 plus Coupé		–	<input type="checkbox"/>
Model name/logo		<input type="checkbox"/>	<input type="checkbox"/>
Side air outlet covers painted in Audi exclusive colour		<input checked="" type="checkbox"/>	<input checked="" type="checkbox"/>

	Page	R8 V10 Coupé	R8 V10 plus Coupé
Interior design	78		
Door sill trims with aluminium inlays		<input type="checkbox"/>	<input type="checkbox"/>
Audi exclusive door sill trims with illuminated aluminium inlay		<input checked="" type="checkbox"/>	<input checked="" type="checkbox"/>
Audi exclusive door sill trims in matt carbon with illuminated aluminium inlay		<input checked="" type="checkbox"/>	<input checked="" type="checkbox"/>
Audi exclusive personalised door sill trims		<input checked="" type="checkbox"/>	<input checked="" type="checkbox"/>
Audi exclusive rear panel and parcel shelf in Alcantara		<input checked="" type="checkbox"/>	<input checked="" type="checkbox"/>
Carpet and floor mats		<input type="checkbox"/>	<input type="checkbox"/>
Audi exclusive carpet and floor mats¹		<input checked="" type="checkbox"/>	<input checked="" type="checkbox"/>
Audi exclusive floor mats		<input checked="" type="checkbox"/>	<input checked="" type="checkbox"/>
Audi exclusive floor mats with R8 logo		<input checked="" type="checkbox"/>	<input checked="" type="checkbox"/>
Pedals and footrest in stainless steel		<input checked="" type="checkbox"/>	<input type="checkbox"/>
Audi exclusive luggage compartment lining in Alcantara¹		<input checked="" type="checkbox"/>	<input checked="" type="checkbox"/>
Audi exclusive sill trim in fine Nappa leather¹		<input checked="" type="checkbox"/>	<input checked="" type="checkbox"/>
Seat backrest covers painted in Audi exclusive colour¹		<input checked="" type="checkbox"/>	<input checked="" type="checkbox"/>
Non-smoker package		<input type="checkbox"/>	<input type="checkbox"/>
Cigarette lighter and ashtray		<input checked="" type="checkbox"/>	<input checked="" type="checkbox"/>
Steering wheels/controls	78		
R8 sport leather steering wheel with multifunction plus and 2 operating satellites		<input type="checkbox"/>	–
R8 performance leather steering wheel with multifunction plus and 4 operating satellites		<input checked="" type="checkbox"/>	<input type="checkbox"/>
R8 selector lever in aluminium look		<input type="checkbox"/>	<input type="checkbox"/>

Audi exclusive leather controls		<input checked="" type="checkbox"/>	<input checked="" type="checkbox"/>
Audi exclusive controls in black suede		<input checked="" type="checkbox"/>	<input checked="" type="checkbox"/>
Mirrors	79		
Exterior mirrors, electrically adjustable and heated, with integrated LED indicator		<input type="checkbox"/>	<input type="checkbox"/>
Exterior mirrors additionally electrically folding and automatically dimming on both sides		<input checked="" type="checkbox"/>	<input checked="" type="checkbox"/>
Exterior mirror housings in body colour		<input type="checkbox"/>	<input type="checkbox"/>
Exterior mirror housings in Audi exclusive gloss carbon		<input checked="" type="checkbox"/>	<input checked="" type="checkbox"/>
Interior mirror, automatically dimming with light/rain sensor		<input type="checkbox"/>	<input type="checkbox"/>
Glazing	79		
Heat-insulating glass		<input type="checkbox"/>	<input type="checkbox"/>
Climate control	79		
Deluxe automatic air conditioning		<input type="checkbox"/>	<input type="checkbox"/>
Closing systems	79		
Convenience key		<input type="checkbox"/>	<input type="checkbox"/>
Garage door opener (HomeLink)		<input checked="" type="checkbox"/>	<input checked="" type="checkbox"/>
Anti-theft alarm		<input type="checkbox"/>	<input type="checkbox"/>
Preparation for tracking system		<input checked="" type="checkbox"/>	<input checked="" type="checkbox"/>
Storage/transport	79		
Storage package		<input checked="" type="checkbox"/>	<input checked="" type="checkbox"/>

Standard equipment Optional equipment – Not available

Country-specific variations possible. Please find out from your local Audi partner which equipment is standard and what optional equipment is available in your country.

¹ For information on when this feature will be available, please contact your Audi partner. ² Only in conjunction with high-beam assist.

	Page	R8 V10 Coupé	R8 V10 plus Coupé
MMI®/navigation	80		
MMI® navigation plus with MMI touch		<input type="checkbox"/>	<input type="checkbox"/>
Audi virtual cockpit		<input type="checkbox"/>	<input type="checkbox"/>
Radio systems	80		
Audi music interface		<input type="checkbox"/>	<input type="checkbox"/>
Audi sound system		<input type="checkbox"/>	<input type="checkbox"/>
Bang & Olufsen Sound System		<input checked="" type="checkbox"/>	<input checked="" type="checkbox"/>
Digital Audio Broadcasting		<input checked="" type="checkbox"/>	<input checked="" type="checkbox"/>
DVD/CD drive		<input type="checkbox"/>	<input type="checkbox"/>
Communication	81		
Audi phone box		<input checked="" type="checkbox"/>	<input checked="" type="checkbox"/>
Bluetooth interface		<input type="checkbox"/>	<input type="checkbox"/>
Audi connect		<input checked="" type="checkbox"/>	<input checked="" type="checkbox"/>
Assistance systems	82		
Parking system plus		<input type="checkbox"/>	<input type="checkbox"/>
Parking system plus with reversing camera		<input checked="" type="checkbox"/>	<input checked="" type="checkbox"/>
Cruise control		<input checked="" type="checkbox"/>	<input checked="" type="checkbox"/>
Driving dynamics/brakes	82		
Electromechanical power steering		<input type="checkbox"/>	<input type="checkbox"/>
Dynamic steering		<input checked="" type="checkbox"/>	<input checked="" type="checkbox"/>
R8 sport suspension		<input type="checkbox"/>	<input type="checkbox"/>

Audi magnetic ride		<input checked="" type="checkbox"/>	<input checked="" type="checkbox"/>
Ceramic brake		<input checked="" type="checkbox"/>	<input type="checkbox"/>
Brake system		<input checked="" type="checkbox"/>	–
Brake callipers, painted in gloss red		<input checked="" type="checkbox"/>	–
Technology/safety	82		
Performance mode		<input checked="" type="checkbox"/>	<input type="checkbox"/>
Audi drive select		<input type="checkbox"/>	<input type="checkbox"/>
Antilock Brake System (ABS)		<input type="checkbox"/>	<input type="checkbox"/>
Anti-Slip Regulation (ASR)		<input type="checkbox"/>	<input type="checkbox"/>
Electronic Differential Lock (EDL)		<input type="checkbox"/>	<input type="checkbox"/>
Electronic Stabilisation Control (ESC)		<input type="checkbox"/>	<input type="checkbox"/>
Recuperation		<input type="checkbox"/>	<input type="checkbox"/>
Start-stop system		<input type="checkbox"/>	<input type="checkbox"/>
S tronic®		<input type="checkbox"/>	<input type="checkbox"/>
Exhaust system with trapezoidal tailpipe trims, chrome-plated		<input type="checkbox"/>	–
Exhaust system with trapezoidal tailpipe trims, gloss black		–	<input type="checkbox"/>
Sport exhaust system with trapezoidal tailpipe trims, gloss black		<input checked="" type="checkbox"/>	<input checked="" type="checkbox"/>
Audi cylinder on demand		<input type="checkbox"/>	<input type="checkbox"/>
quattro®		<input type="checkbox"/>	<input type="checkbox"/>
Audi Space Frame (ASF®) body		<input type="checkbox"/>	<input type="checkbox"/>
73 l fuel tank		–	<input type="checkbox"/>
83 l fuel tank		<input type="checkbox"/>	<input checked="" type="checkbox"/>

	Page	R8 V10 Coupé	R8 V10 plus Coupé
Airbags with front-passenger airbag deactivation		<input type="checkbox"/>	<input type="checkbox"/>
Side impact protection		<input type="checkbox"/>	<input type="checkbox"/>
Side airbags, front, and head airbag system		<input type="checkbox"/>	<input type="checkbox"/>
Integrated head restraint system		<input type="checkbox"/>	<input type="checkbox"/>
Seat belts		<input type="checkbox"/>	<input type="checkbox"/>
Seat belt reminder		<input type="checkbox"/>	<input type="checkbox"/>
First-aid kit with warning triangle		<input type="checkbox"/>	<input type="checkbox"/>
ISOFIX child seat mounting for the front-passenger seat		<input checked="" type="checkbox"/>	<input checked="" type="checkbox"/>
Audi Extended Warranty	83		
Audi Extended Warranty		<input checked="" type="checkbox"/>	<input checked="" type="checkbox"/>

Equipment for the R8 V10 plus Coupé illustrated (p. 9–22):

Paint finish: dynamite red with sideblades in carbon; wheels: 19" forged aluminium wheels in 5-twin-spoke design in matt titanium look, gloss turned finish¹; seats/seat upholstery: R8 bucket seats, front, with fine Nappa leather upholstery and trim in rotor grey, perforated; inlays and extended inlays in matt carbon









Equipment for the R8 V10 Coupé illustrated (p. 8, 24–33):

Paint finish: Daytona grey, pearl effect with sideblades in matt titanium grey; wheels: 20" forged aluminium wheels in 10-spoke Y design, gloss turned finish¹; seats/seat upholstery: R8 sport seats, front, with fine Nappa leather upholstery and trim with diamond pattern in Vermont brown; inlays: Audi exclusive piano finish look, black

¹Please note the special information relating to wheels on page 84.

Classifications of tyre parameters

The table shows the fuel efficiency, wet grip and exterior noise emission classes for the different tyre sizes of the Audi R8 Coupé.

	Tyre size	Fuel efficiency class	Wet grip class	Exterior noise emission class
Summer tyres	245/35 R 19	E	A	72 
	295/35 R 19	E	A	75 
	245/30 R 20	E	A	71 
Winter tyres	305/30 R 20	E	A	72 
	245/35 R 19	C	C	72 
	295/35 R 19	C	C	75 
	245/30 R 20	E	C	72 
	295/30 R 20	E	C	75 

It is not possible to order a specific tyre. Ask your Audi partner about the range of tyres available in your country.

Standard equipment Optional equipment – Not available

Country-specific variations possible. Please find out from your local Audi partner which equipment is standard and what optional equipment is available in your country.



Responsibility

Living up to our responsibilities is a principle that is firmly anchored in Audi strategy. Alongside commercial success and international competitiveness, our responsibility toward company employees and society as a whole is a key consideration, as is protecting the environment and conserving resources. And what is true in the details – our catalogues are printed on FSC-certified paper – also holds in general: Audi develops cars that are not only sporty and emotive but also ever more efficient. In the

long run, Audi wants its products to allow CO₂-neutral mobility. Seeing to it that production in Audi plants gradually becomes CO₂-neutral is another aspect of our comprehensive approach. Audi is also committed to society – particularly in the fields of education, technology and social projects. At Audi, sustainability is closely linked with how we see the future: the Audi Urban Future Initiative sees Audi working with international experts to get to the root of future urban challenges and trends in mobility.



Discover the world of Audi.

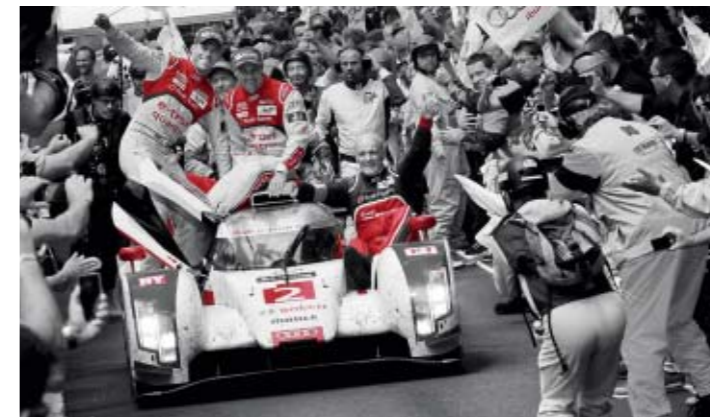

The Audi experience

The fascination of Audi can be experienced in many different ways. Audi City Berlin, Audi City London and Audi City Beijing, for example, give you digital access to all models in their actual size and in real time. And of course it is always worth visiting one of the major motor shows. This is where Audi always presents its new models and invites you to take a look at how the future is being shaped with “Vorsprung durch Technik”. Anyone interested in seeing how Audi is already putting this into practice will find fascinating insight in the “Vorsprung durch Technik” online special at www.audi.com. But a look back can also be rewarding: at the Audi museum mobile in Ingolstadt, history and high-tech go hand in hand. A total of 130 historic exhibits and state-of-the-art forms

of presentation make for a thrilling symbiosis. Plus, Audi driving experience allows you to live the excitement and countless possibilities of current Audi models. Here, pure driving enjoyment is combined with valuable learning effects. This is ensured by a team of specially trained and highly qualified instructors who provide practical tips to help you optimise your driving skills. All this can now also be enjoyed at the recently opened Audi driving experience center in Neuburg, near Ingolstadt. Facilities here include a circuit of up to 3.4 kilometres that features challenging combinations of bends, a 30,000 m² dynamic driving area and an offroad section where Q models can be put through their paces.

Team spirit

Motorsport is a driving force behind the brand. For years Audi has been among the champions in various racing series, for instance the 24 Hours of Le Mans or the DTM German Touring Car Masters. The values that are crucial in many different areas of sport are also central ones for Audi: precision, passion and technology. No coincidence then that Audi has been sponsoring sporting events for

many years. In the world of winter sports, for example, Audi has been the main sponsor of the German Ski Association (DSV) for almost three decades and has also partnered 16 other national alpine teams. In football, we support national and international teams. And Audi is also a partner for the German Olympic Sports Confederation.

Choosing an Audi means choosing a brand that offers more. More individuality. More exclusivity. More fascination.

www.audi.com

Information on all the topics mentioned above can be found on our website: www.audi.com.



www.audi.com



configurator.audi.com



www.audi.com/vorsprung-durch-technik



www.audi.com/driving



www.audi.com/cr



quattro GmbH
85045 Ingolstadt
www.audi.com
Valid from May 2015



Printed in Germany
558/1221.00.18

The models and equipment versions illustrated and described in this brochure and some of the services listed are not available in all countries. Some of the cars illustrated are equipped with optional features for which an extra charge is made. Details concerning the delivery specifications, appearance, performance, dimensions and weights, fuel consumption and running costs of the vehicles were correct to the best of our knowledge at the time of going to press. Deviations from the colours and shapes shown in the illustrations may occur. No liability is accepted for errors and printing errors. The right to introduce modifications is reserved. Not to be reproduced, including in part, without the written approval of AUDI AG.

This brochure is printed on paper made from pulp bleached without the use of chlorine.

