

CX-9



mazda



zoom-zoom

IMAGINATION DRIVES US

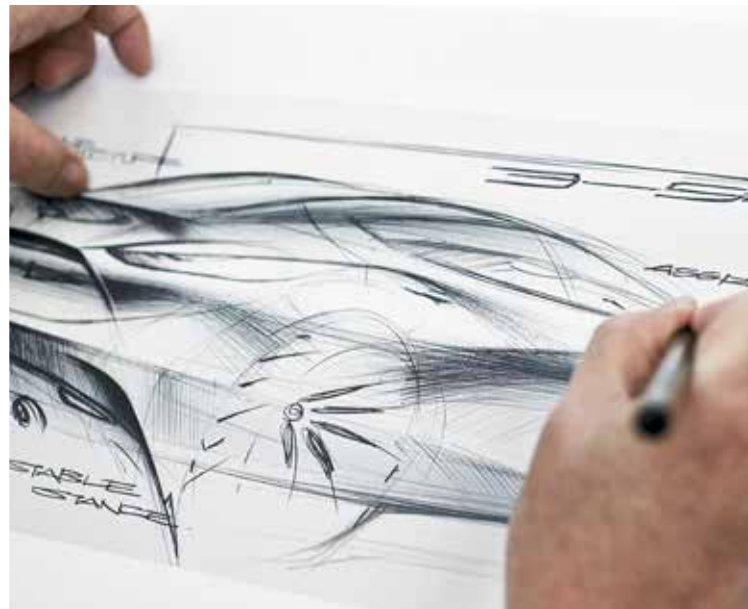

Imagination is the world's most valuable resource. It's our window to the future, because if we can imagine it, we can create it. Mazda is built on a foundation of imagination and ingenuity. It's the fuel behind all we create and achieve. It has given us SKYACTIV TECHNOLOGY, 'KODO – Soul of Motion' design and countless successes that once existed only in someone's imagination. These pages show how imagination is an integral part of our innovative cars.

CONTENTS

04	INTRODUCTION
06	EXTERIOR
08	INTERIOR
10	PERFORMANCE
12	SKYACTIV
14	CONNECTIVITY
16	CAPACITY
18	SAFETY
20	i-ACTIVSENSE
22	MODELS
32	SPECIFICATIONS
38	CONFIDENCE
39	COLOUR & TRIM

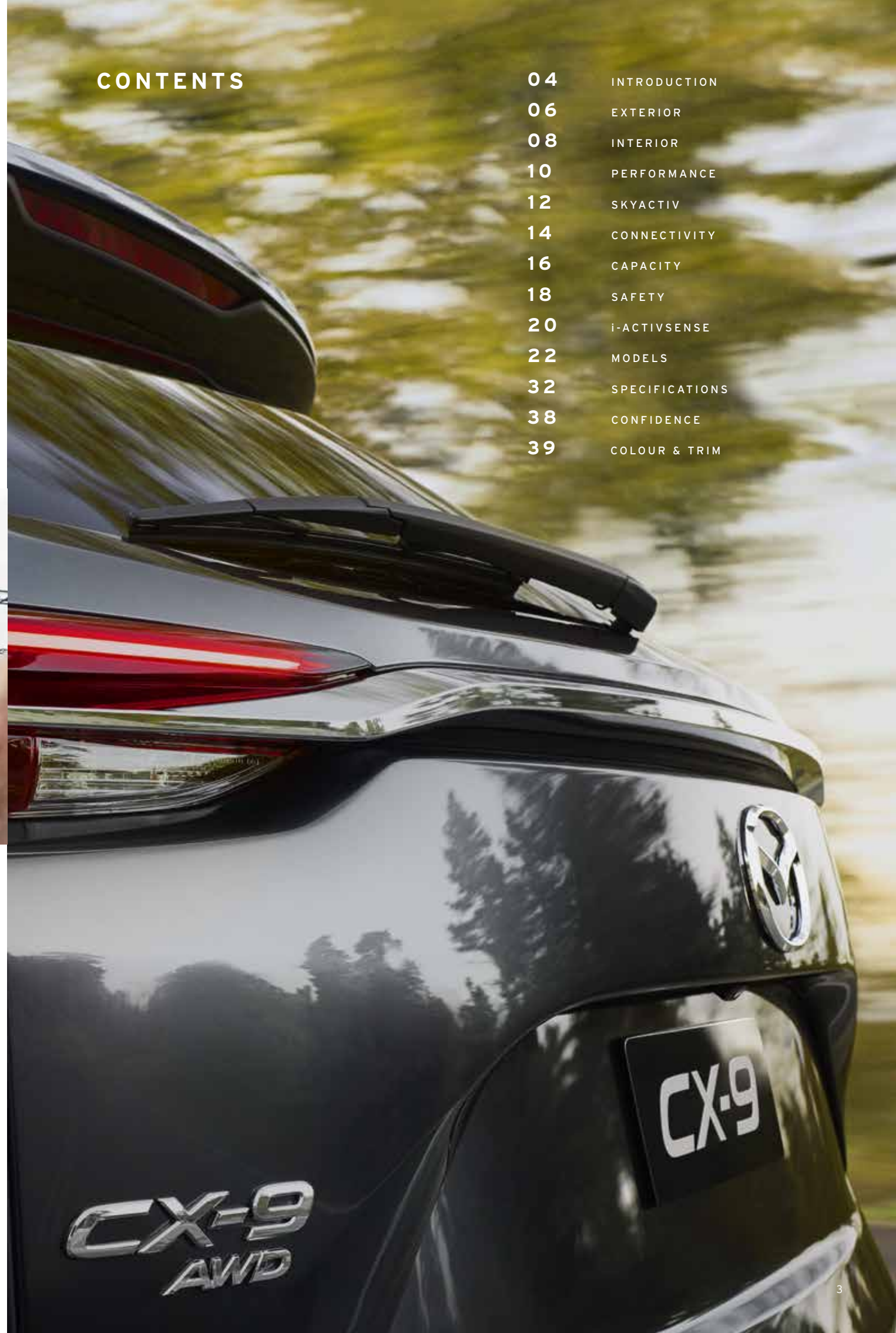



LUXURY MEETS FAMILY

Mazda CX-9 is the ultimate blend of sophisticated luxury and family SUV. The breakthrough SKYACTIV-G 2.5T petrol engine delivers thrilling performance with real-world efficiency. Mazda CX-9 cuts an elegant figure on the road thanks to the superb styling of 'KODO - Soul of Motion' design. The spacious interior is finished with quality craftsmanship that is evident in every detail. Add to that the latest in connectivity including Apple CarPlay® and Android® Auto, passenger comforts and i-ACTIVSENSE advanced safety technologies and you've got an SUV that brings luxury and family together like no other.

KODOMO



魂動

KODO : SOUL of MOTION

Azami LE in Machine Grey Metallic.

ARRIVE IN STYLE

The elegant styling of Mazda CX-9 redefines the seven-seat family SUV. Featuring stunning 'KODO - Soul of Motion' design, the bold lines command a striking street presence.

Mazda CX-9's confident front grille and strong, stable lower body give it an assured stance on the road. Impressive 20-inch wheels further enhance the look, while integrated LED headlamps and tail lights add a sleekness you wouldn't expect in a family SUV.





Azami LE in Chroma brown nappa leather.*



REFINEMENT AT EVERY TURN

Mazda CX-9 indulges every passenger with unprecedented comfort, technology and spaciousness. Every element of the cabin features exceptional design and superb craftsmanship.

The elegantly finished front row envelops the driver with thoughtfully positioned controls, and enjoys extra comforts such as ventilated seats and a heated steering wheel on Azami grades and higher. The Azami LE grade also receives real wood trim, hand-crafted box stitch steering wheel and Chroma brown nappa leather*. The middle and rear passengers are accommodated in full comfort, with plush seating and ample legroom.

* Leather interior includes some Maztex material on selected high-impact surfaces.



BREAKTHROUGH FAMILY SUV PERFORMANCE

Mazda CX-9 features the breakthrough SKYACTIV-G 2.5T petrol engine. This 2.5-litre direct injection turbocharged engine delivers an athletic driving performance that's previously unheard of in a family SUV.

Enjoy powerful acceleration and an excellent response in the low-to-mid rpm range without turbo lag. This traditional problem has been overcome by the Dynamic Pressure Turbo - a world-first turbocharging system that adapts its processes according to engine speed.

The addition of intelligent i-ACTIV AWD monitors and even predicts road conditions so Mazda CX-9 can adjust its performance to deliver exceptional real-world fuel efficiency and a superior drive every time.

POWER AND EFFICIENCY

Mazda CX-9 delivers breakthrough performance with a top-of-the-range engine bringing new levels of driving pleasure. The smooth ride and athletic responses come from the latest advances in SKYACTIV TECHNOLOGY, of which Mazda CX-9 boasts the full suite. Unleashing exceptional efficiency, clever technologies like i-ELOOP have found even more ways to save on fuel and emissions. Mazda CX-9 also includes SKYACTIV-VEHICLE DYNAMICS, a series of technologies that integrates control of the engine, transmission, chassis and body to enhance the sense of oneness between car and driver that we call Jinba Ittai.

*Combined fuel consumption figures are based on ADR 81/02 test results. They are useful in comparing the fuel consumption of different vehicles. They may not be the fuel consumption achieved in practice. This will depend on traffic, road conditions and how the vehicle is driven.



SKYACTIV-G 2.5T TURBO ENGINE

The first turbocharged engine to join the SKYACTIV-G series, the SKYACTIV-G 2.5T delivers both outstanding low and mid-range torque, with excellent fuel economy. The Dynamic Pressure Turbo system controls exhaust pulses to produce a huge 420Nm of torque and 170kW of power. Meanwhile the Cooled Exhaust Gas Recirculation (EGR) cycles cooled exhaust gas back into the air intake system, lowering the engine's fuel consumption and improving economy.



i-ACTIV AWD INTELLIGENT ALL-WHEEL DRIVE SYSTEM

Mazda's i-ACTIV AWD is a predictive, on-demand AWD system that anticipates front tyre slip and applies just enough torque to the rear wheels to prevent slipping from occurring. It does this via 27 sensors, which constantly monitor the road surface, outside conditions, driver operation and vehicle condition. Analysing this information 200 times per second, the system helps ensure a stress-free drive in a wide range of conditions.



SKYACTIV-DRIVE AUTOMATIC TRANSMISSION

We've combined the best attributes of conventional automatic, continuously variable and dual clutch transmissions. The transmission locks up to couple directly with the engine over a wider spectrum than other automatics, delivering a more direct, manual-like power delivery and driving feel. Shifts are swift, accurate and smooth across the six speeds.



i-ELOOP

Mazda's unique brake energy regeneration system captures braking energy in a capacitor that then reroutes that energy to power various electrical systems. On top of reducing fuel consumption, the capacitor charges and discharges faster than conventional battery systems. Intelligent i-stop saves even more fuel by switching off the engine when you come to a standstill, restarting the moment you accelerate.



SKYACTIV-BODY

The new-generation features an advanced body, making it lighter and more rigid than ever for superior handling. Increased use of high-tensile steel saves on weight while increasing strength. The exceptional new design also results in a quieter, more premium ride thanks to sound-absorbent materials, improved door seals and sound-insulating glass.



SKYACTIV-CHASSIS

Passengers experience a smooth, comfortable ride thanks to strut suspension in the front and multi-link suspension in the rear. The angle of the dampers has been optimised and solid rear bushings in the front have been replaced with a liquid variety that provides superior ratios of stiffness and compliance. These enhancements noticeably reduce the overall feeling of road vibration for optimum passenger comfort.



Azami in Black leather.*



CONNECTIVITY THAT COMES WITH YOU

Mazda CX-9 is fully-equipped to handle the entertainment demands of modern families, offering the latest in connectivity and infotainment. Four USB ports are distributed throughout the cabin to accommodate all your devices. Up front, Apple CarPlay® and Android® Auto as well as MZD Connect, standard on every grade, allows you to safely access your compatible smartphone's§ apps, contacts, social media and music, while Sat Nav guides you from a large, upright touch screen controlled by a central dial.

* Leather interior includes some Maztex material on selected high-impact surfaces.

§ Please check the compatibility of your Bluetooth® device (particularly your mobile phone) with the specific Mazda vehicle you intend to purchase as not all devices operate correctly. Visit www.mazda.com.au/Bluetooth or consult your Mazda Dealer for further information.



Azami in Natural stone leather.*



ADAPTS TO YOUR LIFESTYLE

Mazda CX-9 effortlessly accommodates the daily demands of the modern family with a versatile cabin that adapts to all your seating and luggage requirements. The third-row is accessed using a mechanism so simple even children can operate it, while added storage space is integrated throughout the cabin to keep clutter stowed neatly out of sight.

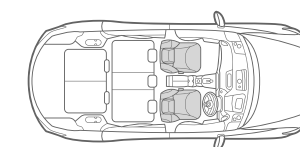
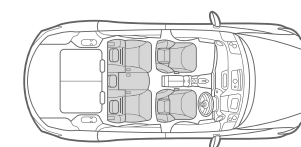
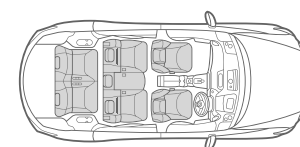

* Leather interior includes some Maztex material on selected high-impact surfaces.



PROTECT YOUR MOST PRECIOUS CARGO

Mazda CX-9 is designed to maximise the safety of every single passenger on board.

The driving environment features excellent visibility, with well-positioned controls to minimise driver distraction† Reverse camera and rear-parking sensors offer extra peace of mind, while the latest advanced braking technologies are fitted to assist you in emergency situations.

Built with a rigid body cell, every grade comes equipped as standard with SRS airbags and technology like Hill Launch Assist. Mazda CX-9 puts your family's safety first, so you can experience true driving confidence.

† Driver-assistance features do not replace the driver's judgement and are not to be used in place of skilled and safe driving practices. It is the driver's sole responsibility to monitor vehicle surroundings and conditions and comply with all applicable laws at all times.



Azami LE in Machine Grey Metallic.

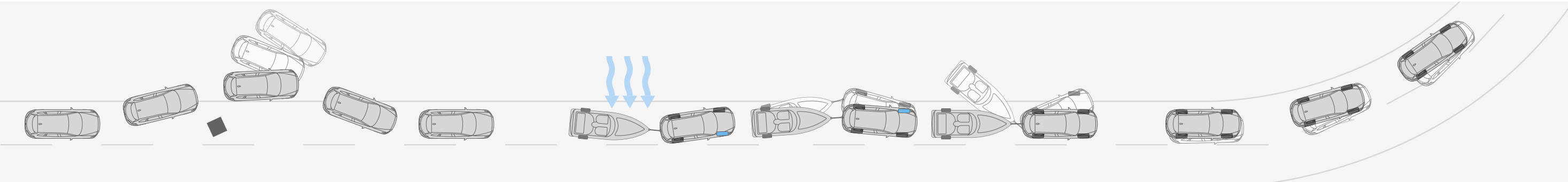

READY TO REACT

If unexpected hazards appear suddenly, Dynamic Stability Control (DSC) acts instantly, braking the inner rear wheel to offset understeer (or outer front wheel to combat oversteer). The Traction Control System (TCS) also reduces torque to the driven wheels to minimise skidding. The hazard can be steered around, as control is maintained.

SAFETY REFLEX

Trailer Stability Assist (TSA) adjusts braking and torque to correct any side-to-side swinging movement of towed loads.

ENJOY THE RIDE

By finely controlling engine torque based on the steering and accelerator inputs of the driver, G-Vectoring Control (GVC) improves both handling for the driver and ride quality for the passengers around corners.

ADVANCED SAFETY TECHNOLOGY LOOKS OUT FOR YOU

Mazda CX-9 comes equipped with a suite of i-ACTIVSENSE advanced safety technologies as standard. i-ACTIVSENSE assists the driver to avoid potential hazards†. Along with preventative features, crash-severity-reduction technology is activated in the event of unavoidable impact.

† i-ACTIVSENSE and other safety technologies are driver assist technologies only and should not be used in place of skilled and safe driving practices. It is the driver's sole responsibility to monitor vehicle surroundings and conditions and comply with all applicable laws at all times.



BLIND SPOT MONITORING (BSM)

By scanning external mirrors' blind spots, radars detect any unseen vehicles to alert the driver of hazardous lane changes. An LED icon on the relevant mirror is accompanied by beeping alerts. Standard across the range.



SMART CITY BRAKE SUPPORT WITH PEDESTRIAN RECOGNITION (SCBS-F/R)

Helps prevent, or lessen, low-speed impacts. Now with pedestrian detection, SCBS-F monitors obstacles in front to assess the possibility of a collision at forward speeds of 4-80km/h. If the system detects a high risk of impact, it issues visual and audible warnings and primes the brakes for faster response, should the driver brake. If the driver does not brake, the brakes are applied automatically. SCBS-R also works in reverse at speeds of 2-8km/h. Standard across the range.

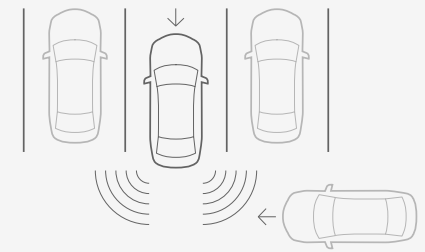

REAR CROSS TRAFFIC ALERT (RCTA)

RCTA assists the driver when reversing from a parking space, warning if a car is approaching from either side of the vehicle. The LED icon on both mirrors is accompanied by a beeping alert. Standard across the range.

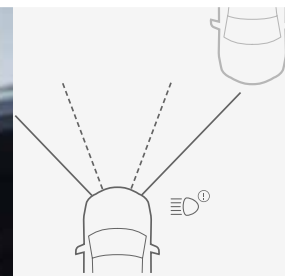

HIGH BEAM CONTROL (HBC)

HBC detects oncoming and preceding vehicles and automatically switches between high and low beams during night driving. This makes it easier for the driver to recognise hazards and helps avoid dazzling other drivers. Standard on Sport to GT models.



TRAFFIC SIGN RECOGNITION (TSR)

TSR uses the forward-sensing camera to recognise Stop, No Entry and speed limit signs which are in turn displayed on the vehicle's Active Driving Display. If the driver exceeds the detected speed limit, a warning will flash on the display. Standard across the range.

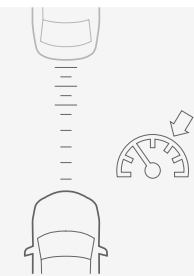

MAZDA RADAR CRUISE CONTROL (MRCC) WITH STOP & GO FUNCTION

MRCC automatically adjusts vehicle speed to maintain a safe distance from the car ahead. It's able to bring the car to a complete stop in traffic and take off again once traffic moves (if the stop is less than 3 seconds). If a complete stop exceeds 3 seconds, the car waits for the driver to initiate acceleration. Standard across the range.

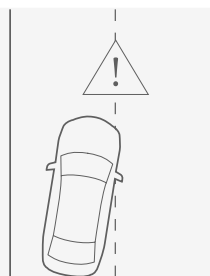

LANE DEPARTURE WARNING (LDW) WITH LANE-KEEP ASSIST SYSTEM (LAS)

LDW uses a windscreen-mounted camera to monitor road lane markings, sounding an audible warning if the driver is about to stray from their lane. LAS will act if it determines the vehicle will leave its lane by applying a degree of corrective steering. Standard across the range.



SMART BRAKE SUPPORT (SBS)

Operating at 15-160km/h, SBS monitors the distance to and speed of the vehicle in front. If SBS senses a high risk of impact, it primes the brakes for faster response. If the driver takes evasive action, SBS deactivates. If no evasive action is taken, the brakes are applied automatically. Standard across the range.

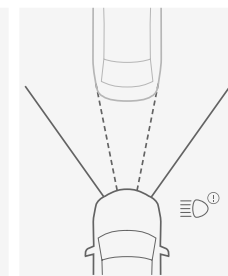

ADAPTIVE LED HEADLAMPS (ALH)

Individual control of several LEDs allows precise adjustment of the lighting pattern. The system automatically broadens visibility at low speeds, shapes the high beam to help avoid dazzling other drivers and raises beam height at highway speeds to extend vision area. Standard on Azami and Azami LE.

CX-9

SPORT



Sport in Deep Crystal Blue Mica.

SPORT FEATURES

- » 18-inch alloy wheels (dark-silver) with 255/60 tyres
- » Headlamps (LED) with auto on/off function
- » Wipers front 2-speed with rain-sensing function
- » Power mirrors (body coloured with heating and auto-folding function)
- » Active Driving Display
- » Air-conditioning (three-zone climate control) with independent rear control
- » Rear-view mirror with auto dimming function
- » Seat trim: Black cloth
- » 7-inch touch screen display (MZD Connect)
- » Audio system with AM/FM tuner, Bluetooth® capability,[§] Digital radio (DAB+) and 6 speakers
- » Apple Carplay® and Android® Auto
- » Advanced keyless push button engine start
- » Blind Spot Monitoring (BSM)[†]
- » Driver Attention Alert (DAA)[†]
- » High Beam Control (HBC)[†]
- » Lane Departure Warning (LDW)[†]
- » Lane-keep Assist System (LAS)[†]
- » Mazda Radar Cruise Control (MRCC) with Stop & Go function[†]
- » Multi-function commander control
- » Parking sensors (rear)
- » Rear Cross Traffic Alert (RCTA)[†]
- » Reverse camera
- » Satellite navigation
- » Smart Brake Support (SBS)[†]
- » Smart City Brake Support [Forward/Reverse] (SCBS F/R)[†]
- » Traffic Sign Recognition (TSR)[†]
- » Tyre Pressure Monitoring System

POWERTRAIN

SKYACTIV-G 2.5T

- » 2.5 litre in-line 4 cylinder 16 valve DOHC S-VT turbo petrol engine with i-stop and i-ELOOP
- » Drivetrain: FWD or i-ACTIV AWD
- » Fuel consumption (combined): 8.4L/100km* (FWD) or 8.8L/100km* (AWD)
- » Max power: 170kW @ 5,000rpm
- » Max torque: 420Nm @ 2,000rpm
- » Transmission: 6-speed auto (SKYACTIV-Drive)

[§] Please check the compatibility of your Bluetooth® device (particularly your mobile phone) with the specific Mazda vehicle you intend to purchase as not all devices operate correctly. Visit www.mazda.com.au/Bluetooth or consult your Mazda Dealer for further information.

[†] i-ACTIVSENSE, other safety technologies and driver-assistance features do not replace the driver's judgement, and should not be used in place of skilled and safe driving practices. It is the driver's sole responsibility to monitor vehicle surroundings and conditions and comply with all applicable laws at all times.

* Combined fuel consumption figures are based on ADR 81/02 test results. They are useful in comparing the fuel consumption of different vehicles. They may not be the fuel consumption achieved in practice. This will depend on traffic, road conditions and how the vehicle is driven.



PLAY IT YOUR WAY

Apple CarPlay® and Android® Auto means you can pair up your compatible smartphone and access a whole range of your favourite apps.[§]



SAFELY SWITCH LANES

Blind Spot Monitoring (BSM) warns of hazardous lane changes with LED icons and beeping alerts.



SAFE DISTANCE

Mazda Radar Cruise Control (MRCC) with Stop & Go function automatically adjusts speed to maintain a safe distance from the car ahead, even in heavy traffic![†]



EXTRA SENSES

Rear camera and rear parking sensors give you added confidence while reversing.

CX-9 TOURING



Touring in Snowflake White Pearl Mica.

TOURING FEATURES

ADDITIONAL TO SPORT

- » 18-inch alloy wheels (bright) with 255/60 tyres
- » Front fog-lamps (LED)
- » Seat trim: Black leather#
- » Front seats with: 6-way power adjustment (passenger), 8-way power adjustment (driver) and heating function
- » Rear seats with: centre armrest storage and USB input ports (2nd row)
- » 8-inch touch screen display (MZD Connect)
- » Advanced keyless entry
- » Parking sensors (front)

POWERTRAIN

SKYACTIV-G 2.5T

- » 2.5 litre in-line 4 cylinder 16 valve DOHC S-VT turbo petrol engine with i-stop and i-ELOOP
- » Drivetrain: FWD or i-ACTIV AWD
- » Fuel consumption (combined): 8.4L/100km* (FWD) or 8.8L/100km* (AWD)
- » Max power: 170kW @ 5,000rpm
- » Max torque: 420Nm @ 2,000rpm
- » Transmission: 6-speed auto (SKYACTIV-Drive)

Leather interior includes some Maztex material on selected high-impact surfaces.

* Combined fuel consumption figures are based on ADR 81/02 test results. They are useful in comparing the fuel consumption of different vehicles. They may not be the fuel consumption achieved in practice. This will depend on traffic, road conditions and how the vehicle is driven.



HEADS UP

The full colour Active Driving Display projects important driving information onto the windscreen into your line of sight.



MAKES LIGHT WORK

Auto on-off headlamps mean one less thing to think about while driving in changing light conditions.

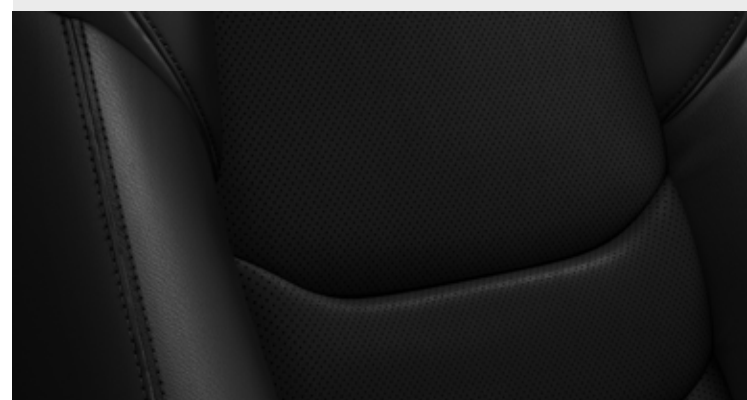

A CUT ABOVE

Luxurious leather# seats in sleek black are timelessly elegant.



STAY IN TOUCH

Large 8-inch communication touch screen puts MZD Connect infotainment at your fingertips.

CX-9

GT



GT in Soul Red Crystal Metallic.

GT FEATURES

ADDITIONAL TO TOURING

- » 20-inch alloy wheels with 255/50 tyres
- » Remote operated power tailgate (open/close)
- » Power sliding and tilt glass sunroof
- » Seat trim: Black or Natural stone leather#
- » Front seats with: 2-position memory function (driver) and 10-way power adjustment (driver)
- » Rear seats with: heating function (2nd row outer)
- » Premium Bose® 294 watt amplifier and 12 speakers (including subwoofer)

POWERTRAIN

SKYACTIV-G 2.5T

- » 2.5 litre in-line 4 cylinder 16 valve DOHC S-VT turbo petrol engine with i-stop and i-ELOOP
- » Drivetrain: FWD or i-ACTIV AWD
- » Fuel consumption (combined): 8.4L/100km* (FWD) or 8.8L/100km* (AWD)
- » Max power: 170kW @ 5,000rpm
- » Max torque: 420Nm @ 2,000rpm
- » Transmission: 6-speed auto (SKYACTIV-Drive)

Leather interior includes some Maztex material on selected high-impact surfaces.

* Combined fuel consumption figures are based on ADR 81/02 test results. They are useful in comparing the fuel consumption of different vehicles. They may not be the fuel consumption achieved in practice. This will depend on traffic, road conditions and how the vehicle is driven.



STUNNING SOUND

A 12-speaker system ensures every passenger enjoys the premium Bose® audio experience.



PARK WITH EASE

Enjoy the added confidence of front parking sensors alerting the distance to objects in front.



HANDS-FREE ACCESS

Power liftgate conveniently lifts the tailgate with the push of a button when your hands are full.



SHINE ON

Bright 20-inch alloys add dynamic edge with their sharp, bold design and high-gloss finish.



Azami in Sonic Silver Metallic.

AZAMI FEATURES

ADDITIONAL TO GT

- » Adaptive LED Headlamps (ALH)*
- » Windscreen de-icer
- » 7-inch TFT LCD multi-information meter display
- » Heated steering wheel
- » Frameless rear-view mirror
- » Front seats with: ventilation function
- » 360° View Monitor†

POWERTRAIN

SKYACTIV-G 2.5T

- » 2.5 litre in-line 4 cylinder 16 valve DOHC S-VT turbo petrol engine with i-stop and i-ELOOP
- » Drivetrain: FWD or i-ACTIV AWD
- » Fuel consumption (combined): 8.4L/100km* (FWD) or 8.8L/100km* (AWD)
- » Max power: 170kW @ 5,000rpm
- » Max torque: 420Nm @ 2,000rpm
- » Transmission: 6-speed auto (SKYACTIV-Drive)

+ i-ACTIVSENSE, other safety technologies and driver-assistance features do not replace the driver's judgement, and should not be used in place of skilled and safe driving practices. It is the driver's sole responsibility to monitor vehicle surroundings and conditions and comply with all applicable laws at all times.

* Combined fuel consumption figures are based on ADR 81/02 test results. They are useful in comparing the fuel consumption of different vehicles. They may not be the fuel consumption achieved in practice. This will depend on traffic, road conditions and how the vehicle is driven.

28 # Leather interior includes some Maztex material on selected high-impact surfaces.



TOUCH THE SKY

The power-operated sliding glass sunroof with tilt function unites the interior with the sky.



BRIGHT LIGHTS

Adaptive LED Headlamps (ALH)* automatically control LED light patterns for optimal road illumination.



LUXURIOUS LEATHER

Beautifully crafted Natural stone leather* seat trim with impeccable stitching adds understated appeal. Black leather also available.



THE COMPLETE PICTURE

The 360° View Monitor employs four cameras to give you a complete aerial view of your surroundings so you can manoeuvre easily and safely!



Azami LE in Machine Grey Metallic.

AZAMI LE FEATURES

ADDITIONAL TO AZAMI

- » Real wood decoration panels
- » Centre console ambient lighting (LED)
- » Hand-crafted box stitch steering wheel
- » Seat trim: Chroma brown nappa leather#
- » Unique overhead console

POWERTRAIN

SKYACTIV-G 2.5T

- » 2.5 litre in-line 4 cylinder 16 valve DOHC S-VT turbo petrol engine with i-stop and i-ELOOP
- » Drivetrain: i-ACTIV AWD
- » Fuel consumption 8.8L/100km* (AWD)
- » Max power: 170kW @ 5,000rpm
- » Max torque: 420Nm @ 2,000rpm
- » Transmission: 6-speed auto (SKYACTIV-Drive)

Leather interior includes some Maztex material on selected high-impact surfaces.

* Combined fuel consumption figures are based on ADR 81/02 test results. They are useful in comparing the fuel consumption of different vehicles. They may not be the fuel consumption achieved in practice. This will depend on traffic, road conditions and how the vehicle is driven.



LUXURIOUS FINISHES

Aluminium and wood trim throughout the cabin offers a sense of premium luxury.



A WARM TOUCH

Once you experience the heated steering wheel you'll wonder how you ever lived without it.



SETTLE INTO STYLE

Enjoy true comfort with a soft touch thanks to Chroma brown nappa leather# seats.



AN AIR OF COMFORT

The ventilated front seats draw warm air away, leaving the occupants more comfortable than ever.

SPECIFICATIONS

Powertrain	2.5L Turbo I4 Petrol FWD	2.5L Turbo I4 Petrol AWD
Bore and stroke (mm)	89.0 x 100.0	89.0 x 100.0
Compression ratio	10.5 : 1	10.5 : 1
Drivetrain	FWD	i-ACTIV AWD
Emissions standard	Euro stage V	Euro stage V
Engine capacity (cc)	2,488	2,488
Engine type	2.5 litre turbo in-line 4 cylinder 16 valve DOHC S-VT petrol (SKYACTIV-G 2.5T) engine	2.5 litre turbo in-line 4 cylinder 16 valve DOHC S-VT petrol (SKYACTIV-G 2.5T) engine
Fuel consumption (l/100km)*:		
Auto (combined)	8.4	8.8
Auto (extra urban)	6.9	7.3
Auto (urban)	11.0	11.4
Fuel system	Electronic direct injection	Electronic direct injection
Fuel tank capacity (litres)	72	74
Gear ratio:		
1st	3.487	3.487
2nd	1.992	1.992
3rd	1.449	1.449
4th	1.000	1.000
5th	0.707	0.707
6th	0.600	0.600
Reverse	3.990	3.990
Final drive	4.411	4.411
Maximum power (kW @ rpm)	170 @ 5,000	170 @ 5,000
Maximum torque (Nm @ rpm)	420 @ 2,000	420 @ 2,000
Recommended fuel	Unleaded (91RON or higher) or E10	Unleaded (91RON or higher) or E10
Throttle control	Electronic (drive-by-wire)	Electronic (drive-by-wire)
Transmission	6-speed (SKYACTIV-Drive)	6-speed (SKYACTIV-Drive)

Model Availability		Sport	Touring	GT	Azami	Azami LE
7-seat SUV:	2.5L Turbo I4 Petrol FWD / 6-speed automatic	●	●	●	●	-
	2.5L Turbo I4 Petrol AWD / 6-speed automatic	●	●	●	●	●

Chassis and Powertrain Technologies	Sport	Touring	GT	Azami	Azami LE
Automatic transmission drive selection	●	●	●	●	●
Automatic transmission kickdown switch	●	●	●	●	●
Dynamic Pressure Turbo system	●	●	●	●	●
Electric Parking Brake	●	●	●	●	●
Electric power assist steering	●	●	●	●	●
i-ACTIV AWD	○	○	○	○	●
i-ELOOP	●	●	●	●	●
i-stop	●	●	●	●	●
SKYACTIV-BODY	●	●	●	●	●
SKYACTIV-CHASSIS	●	●	●	●	●
SKYACTIV-VEHICLE DYNAMICS G-Vectoring Control (GVC)	●	●	●	●	●

Chassis	Sport	Touring	GT	Azami	Azami LE
Brake diameter (mm):	Front	----- 320 -----			
	Rear	----- 325 -----			
Brake type:	Front	----- Ventilated disc -----			
	Rear	----- Solid disc -----			
Suspension:	Front	----- MacPherson strut -----			
	Rear	----- Multi-link -----			
Turning circle kerb to kerb (m)	----- 11.8 -----				
Tyre size	255/60 R18	255/60 R18	255/50 R20	255/50 R20	255/50 R20
Tyre index	108H	108H	105V	105V	105V
Wheel size	18 x 8.0 J	18 x 8.0 J	20 x 8.5 J	20 x 8.5 J	20 x 8.5 J
Wheel type	----- Alloy -----				
Tyre size (spare)	----- 185/80 R17 -----				
Wheel size (spare)	----- 17 x 5.5 J -----				
Wheel type (spare)	----- Temporary (Steel) -----				

Weights and Capacities	Sport	Touring	GT	Azami	Azami LE	
Cargo volume VDA [‡] (litres)	230	230	230	230	230	
Cargo volume VDA [^] (litres)	810	810	810	810	810	
Gross Vehicle Mass (GVM) (kg):	2.5L Turbo I4 Petrol FWD / 6-speed automatic	2,505	2,505	2,505	2,505	-
	2.5L Turbo I4 Petrol AWD / 6-speed automatic	2,575	2,575	2,575	2,575	2,575
Kerb weight (kg):	2.5L Turbo I4 Petrol FWD / 6-speed automatic	1,878	1,878	1,928	1,928	-
	2.5L Turbo I4 Petrol AWD / 6-speed automatic	1,950	1,950	2,000	2,000	2,000
Payload capacity (kg):	2.5L Turbo I4 Petrol FWD / 6-speed automatic	627	627	577	577	-
	2.5L Turbo I4 Petrol AWD / 6-speed automatic	625	625	575	575	575
Towing capacity [⌘] (kg):	Braked	2,000	2,000	2,000	2,000	2,000
	Unbraked	750	750	750	750	750
Tow ball download maximum (kg)	150	150	150	150	150	

● = Standard, ○ = Option, - = Not available.

* Fuel consumption figures are based on ADR 81/02 test results. They are useful in comparing the fuel consumption of different vehicles. They may not be the fuel consumption achieved in practice. This will depend on traffic and road conditions and how the vehicle is driven.

‡ Measured with 3rd row seats up and up to roof.

^ Measured with 3rd row seats folded down and up to roof.

⌘ When fitted with a Mazda Genuine Towing kit. Subject to State and Territory regulations.

Dimensions		Sport	Touring	GT	Azami	Azami LE
Ground clearance (mm):	Laden	220	220	220	220	220
	Unladen	222	222	222	222	222
Overall length (mm)		5,075	5,075	5,075	5,075	5,075
Overall width (mm)		1,969	1,969	1,969	1,969	1,969
Overall height (mm)		1,747	1,747	1,747	1,747	1,747
Track (mm):	Front	1,663	1,663	1,663	1,663	1,663
	Rear	1,663	1,663	1,663	1,663	1,663
Wheelbase (mm)		2,930	2,930	2,930	2,930	2,930

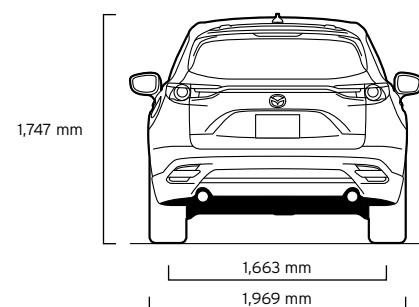
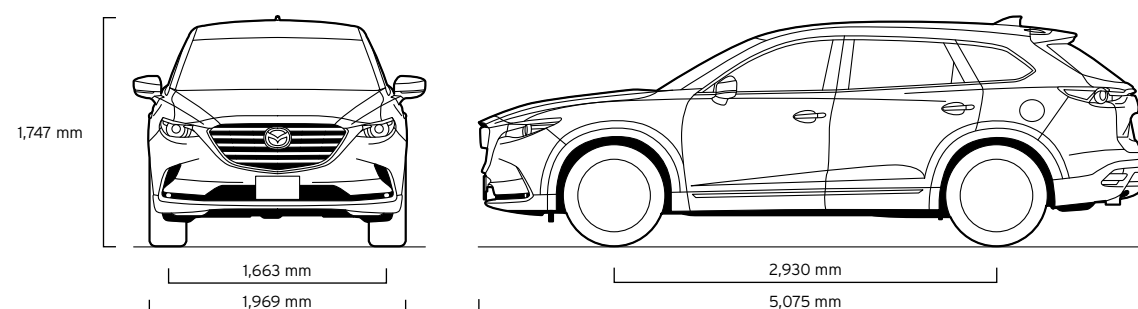

Exterior	Sport	Touring	GT	Azami	Azami LE
Daytime running lamps (Halogen)	●	●	●	-	-
Daytime running lamps (LED)	-	-	-	●	●
Door handles (body coloured)	●	●	●	●	●
Exhaust extensions (chrome)	●	●	●	●	●
Front fog-lamps (LED)	-	●	●	●	●
Front and rear bumpers (body coloured)	●	●	●	●	●
Green-tinted windscreen, side and rear windows	●	●	●	●	●
Headlamps (LED)	●	●	●	●	●
Headlamps auto on/off function	●	●	●	●	●
Power mirrors (body coloured with heating and auto-folding function)	●	●	●	●	●
Power sliding and tilt glass sunroof	-	-	●	●	●
Power windows	●	●	●	●	●
Rear spoiler	●	●	●	●	●
Remote operated power tailgate (open/close)	-	-	●	●	●
Tail-lamps (LED)	●	●	●	●	●
Window demister (rear)	●	●	●	●	●
Windscreen de-icer	-	-	-	●	●
Wipers (front) 2-speed with rain-sensing function	●	●	●	●	●
Wiper (rear) with intermittent function	●	●	●	●	●

Seats	Sport	Touring	GT	Azami	Azami LE
Front seats with:	2-position memory function (driver)	-	-	●	●
	6-way power adjustment (passenger)	-	●	●	●
	8-way power adjustment (driver)	-	●	-	-
	10-way power adjustment (driver)	-	-	●	●
	Adjustable head restraints	●	●	●	●
	Heating function	-	●	●	●
	Height adjustment	●	●	●	●
	Lumbar support adjustment (driver)	-	●	●	●
	Rake and slide adjustment	●	●	●	●
	Seat back pockets	●	●	●	●
Rear seats with:	Ventilation function	-	-	-	●
	60/40 split fold backrest (2nd row)	●	●	●	●
	50/50 split fold backrest (3rd row)	●	●	●	●
	Adjustable head restraints	●	●	●	●
	Centre fold down armrest (2nd row)	●	-	-	-
	Centre fold down armrest with USB and storage (2nd row)	-	●	●	●
	Heating function (2nd row, outer)	-	-	●	●
	Rake and slide adjustment (2nd row)	●	●	●	●
Seat trim:	Black cloth	●	-	-	-
	Black leather#	-	●	●	-
	Natural stone leather#	-	-	○	○
	Chroma brown nappa leather#	-	-	-	-

● = Standard, ○ = Option, - = Not available.

SPECIFICATIONS

Interior	Sport	Touring	GT	Azami	Azami LE
7-inch TFT LCD multi-information meter display	-	-	-	●	●
Active Driving Display	●	●	●	●	●
Air-conditioning (three-zone climate control) with independent rear control and vents (2nd row)	●	●	●	●	●
Ambient temperature display	●	●	●	●	●
Cargo area 12 volt power outlet	●	●	●	●	●
Centre armrest console	●	●	●	●	●
Critical function warning lights/chimes	●	●	●	●	●
Cupholders	●	●	●	●	●
Door bottle holders (front and rear)	●	●	●	●	●
Glove box	●	●	●	●	●
Heated steering wheel function	-	-	-	●	●
Instrument panel light dimmer	●	●	●	●	●
Interior illumination:					
Cargo room lamp	●	●	●	●	●
Entry system with delayed fade	●	●	●	●	●
Map reading spot lamps (Incandescent)	●	●	-	-	-
Map reading spot lamps (LED)	-	-	●	●	●
Power window switch	●	●	●	●	●
Leather-wrapped:					
Gear shift knob	●	●	●	●	●
Steering wheel	●	●	●	●	●
Mazda Radar Cruise Control with Stop & Go function	●	●	●	●	●
One touch (up and down) power windows (front and rear)	●	●	●	●	●
Overhead sunglass storage box	●	●	●	●	●
Rear door window sunshade	-	-	●	●	●
Rear-view mirror with auto dimming function	●	●	●	●	●
Tachometer and electronic odometer/tripmeter	●	●	●	●	●
Tilt and telescopic adjustable steering wheel	●	●	●	●	●
Trip computer	●	●	●	●	●
Vanity mirrors (front) with illumination	●	●	●	●	●

Infotainment	Sport	Touring	GT	Azami	Azami LE
7-inch full colour touch screen display (MZD Connect)	●	-	-	-	-
8-inch full colour touch screen display (MZD Connect)	-	●	●	●	●
AM/FM tuner	●	●	●	●	●
Apple Carplay® and Android® Auto	●	●	●	●	●
Auxiliary-audio input jack (3.5mm mini-stereo)	●	●	●	●	●
Bluetooth® hands-free phone and audio capability [§]	●	●	●	●	●
Digital radio (DAB+)	●	●	●	●	●
Internet radio integration (Stitcher™ and Aha™)	●	●	●	●	●
Multi-function commander control	●	●	●	●	●
Premium Bose® 294 watt amplifier and speakers	-	-	●	●	●
Radio Data System (RDS) program information	●	●	●	●	●
Satellite navigation	●	●	●	●	●
Speakers (6)	●	●	-	-	-
Speakers (12)	-	-	●	●	●
Steering wheel-mounted audio controls	●	●	●	●	●
USB-audio input port (iPod® compatible)	●	●	●	●	●

Safety and Security	Sport	Touring	GT	Azami	Azami LE
360° View Monitor	-	-	-	●	●
Adaptive LED Headlamps (ALH)	-	-	-	●	●
Blind Spot Monitoring (BSM)	●	●	●	●	●
Advanced keyless entry	-	●	●	●	●
Advanced keyless push-button engine start	●	●	●	●	●
Airbags SRS:					
Front (driver and passenger)	●	●	●	●	●
Side (front)	●	●	●	●	●
Curtain (front and rear)	●	●	●	●	●
Anti-lock Braking System (ABS)	●	●	●	●	●
Auto Door Lock (ADL)	●	●	●	●	●
Childproof rear door locks	●	●	●	●	●
Child restraint anchorage points:					
ISOFIX (x2)	●	●	●	●	●
Top tether (x5)	●	●	●	●	●
Driver Attention Alert (DAA)	●	●	●	●	●
Dynamic Stability Control (DSC)	●	●	●	●	●
Electronic Brake-force Distribution (EBD)	●	●	●	●	●
Emergency Brake Assist (EBA)	●	●	●	●	●
Emergency Stop Signal (ESS)	●	●	●	●	●
Engine immobiliser	●	●	●	●	●
Forward Obstruction Warning (FOW)	●	●	●	●	●
High Beam Control (HBC)	●	●	●	-	-
High mount stop lamp	●	●	●	●	●
Hill Launch Assist (HLA)	●	●	●	●	●
Intrusion-minimising brake pedal	●	●	●	●	●
Lane Keep-assist System (LAS)	●	●	●	●	●
Lane Departure Warning (LDW)	●	●	●	●	●
Left-hand-side convex (wide angle) exterior mirror	●	●	●	●	●
Parking sensors (front)	-	●	●	●	●
Parking sensors (rear)	●	●	●	●	●
Rear Cross Traffic Alert (RCTA)	●	●	●	●	●
Remote central locking (2 transmitters)	●	●	●	●	●
Reverse camera	●	●	●	●	●
Roll Stability Control (RSC)	●	●	●	●	●
Seat-belt warning (front and rear)	●	●	●	●	●
Seat-belts 3-point lap-sash (all seats)	●	●	●	●	●
Seat-belts (front) with pretensioners, load-limiters and height adjustable shoulder anchorages	●	●	●	●	●
Seat-belts (2nd row) with pretensioners and load-limiters	●	●	●	●	●
Side impact door beams	●	●	●	●	●
Smart Brake Support (SBS)	●	●	●	●	●
Smart City Brake Support [Forward/Reverse] (SCBS F/R)	●	●	●	●	●
Traction Control System (TCS)	●	●	●	●	●
Trailer Stability Assist (TSA)	●	●	●	●	●
Traffic Sign Recognition (TSR)	●	●	●	●	●
*Triple H' safety construction with front and rear crumple zones	●	●	●	●	●
Tyre Pressure Monitoring System (TPMS)	●	●	●	●	●
Whiplash-minimising front seats	●	●	●	●	●

● = Standard, - = Not available.

[§] Please check the compatibility of your Bluetooth® device (particularly your mobile phone) with the specific Mazda vehicle you intend to purchase as not all devices operate correctly. Visit www.mazda.com.au/Bluetooth or consult your Mazda Dealer for further information.

ENJOY MAZDA CX-9 WITH CONFIDENCE



MAZDA CX-9 COLOUR AND TRIM

BODY COLOURS



Snowflake White Pearl Mica

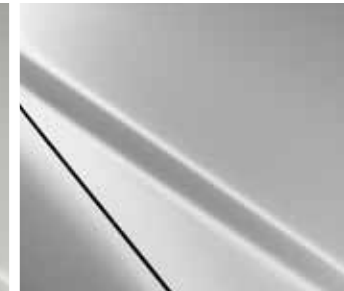

Sonic Silver Metallic



Soul Red Crystal Metallic[■]



Machine Grey Metallic[■]



Titanium Flash Mica[■]



Deep Crystal Blue Mica[■]



Jet Black Mica[■]

INTERIOR TRIMS

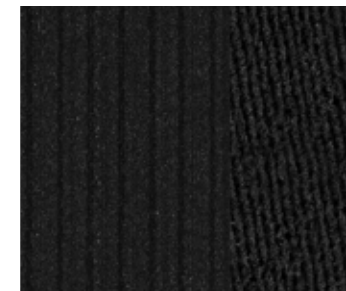

Black cloth
(Sport)



Black leather[#]
(Touring, GT and Azami)

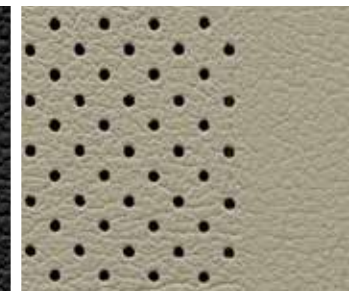

Natural stone leather^{#■}
(GT and Azami)

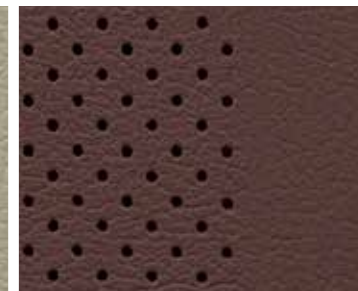

Chroma brown nappa leather[#]
(Azami LE)



REST ASSURED – YOUR WARRANTY

The quality built into Mazda CX-9 is backed up by a 5 year, unlimited kilometre factory warranty and 6 year panel protection warranty.*



MAINTAIN THAT ZOOM-ZOOM

Your Mazda CX-9 deserves the best in care. Servicing with Mazda Service Select gives your car the advantage of factory trained Service Technicians and advanced computer diagnostic systems. As well as maintaining your Mazda in A1 condition, you'll also be protecting your vehicle's outstanding resale value.

HELP IS AT HAND – MAZDA ROADSIDE ASSISTANCE

Flat batteries, running out of fuel, flat tyres – everyone faces hiccups from time to time. When the unexpected happens, Mazda Roadside Assistance is there to keep you moving. You'll be covered 24 hours a day, 365 days a year, all round Australia. Better still, your Mazda will only be worked on by Mazda-approved technicians. Choose a Standard policy offering everything needed to get going again, or Premium with extras like accommodation, a rental car and vehicle recovery. Either can be purchased across the entire Mazda range. (Terms and conditions apply.)

* New 5 year unlimited kilometre warranty available on all brand new vehicles purchased from 1 August 2018. For full terms and conditions please visit <https://www.mazda.com.au/owners/warranty/>

[^] At extra cost.

[■] Natural stone leather interior only available with Soul Red Crystal Metallic, Machine Grey Metallic, Titanium Flash Mica, Deep Crystal Blue Mica and Jet Black Mica exterior colours.

[#] Leather interior includes some Maztex material on selected high-impact surfaces.

All care is taken to ensure the accuracy of this brochure and availability of vehicles and features at the time of publication, however, to the extent permitted by law, Mazda Australia Pty Ltd will not be liable for any loss suffered or incurred by a purchaser or prospective purchaser if the content is inaccurate or not up to date, or if it withdraws any vehicles or features referred to in the brochure from the market. Specifications, features and model availability may vary from State to State and may change without notice. Please refer to mazda.com.au or consult your Mazda Dealer prior to placing an order to ascertain current information on model availability, specifications, options, features and prices. Mazda Australia Pty Ltd ABN 78 004 690 804. 211A Wellington Road, Mulgrave, Victoria 3170. iPod is a trademark of Apple Inc., registered in the U.S. and other countries. Due to the nature of the printing process, colours may vary from those shown in this brochure. Ask your Dealer to show you a product sample.

IMAGINATION DRIVES US



Facebook.com/
MazdaAus



YouTube.com/
ZoomZoom



Twitter.com/
MazdaAus



Instagram.com/
MazdaAus

Published August 2018. MAZ13755 129.622

For further information visit mazda.com.au or Freecall 1800 034 411

*MAZDA
GENUINE
ACCESSORIES*

CX-9



ZOOM-ZOOM





MOBILE PHONE HOLDER

Safe, stylish and compatible with many popular phones, this gives drivers easy phone visibility and access. Allows for portrait or landscape use.



REAR SEAT ENTERTAINMENT HOLDER FOR IPAD®

Keep rear seat passengers entertained with this convenient holder for your iPad®

MAKE YOUR MAZDA EVEN MORE REWARDING

New Mazda CX-9 is the seven seat SUV where luxury meets family. Mazda Genuine Accessories enhance the styling and practical features, while customising and protecting your investment. Featuring outstanding design, quality, fit and safety, each accessory comes backed by a Mazda Warranty. Mazda Genuine Accessories add extra Zoom-Zoom to your CX-9 and indulge your family even more.



FRONT FLOOR MATS

Protect your carpet with these high-quality, tailor-made floor mats. Fastening system enhances safety. (Front and rear sold separately)



REAR WINDOW SHADES

Provide sun protection for rear passengers and cargo. (Set of two) (Sport and Touring models only)



CARGO ORGANISER BOX

Prevent items from sliding around in the cargo area. Features moveable internal dividers, detachable lids and a securable base.



CARGO NET

Restrain smaller cargo items in the load compartment with this easily removable netting.



FRONT SEAT COVERS

These durable, waterproof neoprene covers keep your seats free from dirt and grime, and offer full airbag compatibility.



REAR SEAT COVERS

Guard against dirt, spills, damage and the effects of wear with this lightweight, waterproof cover.



CARGO TRAY

A durable, custom-fitted tray with raised edges to protect the load compartment from spills, dirt and scratches.



BOOT LIP PROTECTOR

Protect your rear bumper and boot lip from scratches and scuffs during loading and unloading.



SCUFF PLATES

Guard door sills from scratches and scuffing with protective plates styled to enhance the look of your CX-9.



WELCOME ILLUMINATION

Welcome lighting radiates soft blue illumination from both foot wells.



CARGO ILLUMINATION

Additional LED lighting that allows for a clearer view of the load compartment.



CARGO COVER

Keep valuable items hidden from view.

FEATURED HERE

- Front mud guards
- Rear mud guards
- Roof racks
- Slimline weathershields
- Tow bar*



*Features maximum 2,000kg braked towing capacity and 150kg tow ball download limit. Subject to State or Territory regulations. Chrome tow ball sold separately.

Azami in Machine Grey Metallic.



BIKE RACK (WHEEL OFF)

Makes it easier to take your bike along for the ride.



BIKE RACK (WHEEL ON)

Transport your bike without the inconvenience of removing a wheel.



UNIVERSAL CARRIER

This streamlined and easy-to-use carrier allows you to bring all sorts of objects along safely and securely.



KAYAK HOLDER

A convenient way to carry a canoe, kayak or similar sized watercraft.



BONNET PROTECTOR

Guards the bonnet against damage caused by road debris. (Smoke Bonnet Protector also available)

HEADLIGHT PROTECTORS

Shield headlamps from costly damage.



FRONT PARKING SENSORS

Take the guesswork out of parking with audio alerts advising the distance between your CX-9 and objects to the front. (Only compatible with Sport model)



FRONT MUDGUARDS

Stop mud and road grime collecting on the front bodywork of your car.



REAR BUMPER STEP PLATE

Protect tailgate paintwork from damage while enhancing its appearance.



COLLAPSIBLE SUN SCREEN

Keep your vehicle cool and protect the interior from the sun's harmful rays.



ELECTRONIC BRAKE CONTROLLER

Supplies power to a towed trailer's electric brakes when the CX-9's brakes are applied.

ALSO AVAILABLE

- Audio retractable Lightning cable
- Audio retractable Micro USB cable
- Black wheel lock set
- Chrome wheel lock set

- Mazda retractable audio cable
- Rear floor mats
- Retractable USB to type C cable

- Tow ball
- Tow ball cover

SEE THE FULL RANGE OF MAZDA GENUINE ACCESSORIES AT MAZDA.COM.AU

All care is taken to ensure the accuracy of this brochure and availability of vehicles and features at the time of publication, however, to the extent permitted by law, Mazda Australia Pty Ltd will not be liable for any loss suffered or incurred by a purchaser or prospective purchaser if the content is inaccurate or not up to date, or if it withdraws any vehicles or features referred to in the brochure from the market. Sports and other equipment shown in the brochure are for illustration purposes only and do not come standard with the vehicle, or as Mazda Genuine Accessories. Specifications, features and availability may vary from State to State and may change without notice. Please refer to mazda.com.au or consult your Mazda Dealer prior to placing an order to ascertain current information on availability, specifications, features and prices. Mazda Australia Pty Ltd ABN 78 004 690 804. 211A Wellington Road, Mulgrave VIC 3170. All Mazda Genuine Accessories fitted at the point of sale of a new Mazda passenger vehicle are covered under the Mazda 5 year/unlimited kilometre warranty. Mazda Genuine Accessories fitted after the sale of a new Mazda vehicle are covered by the Mazda 2 year or 40,000 kilometre warranty (whichever should occur first). New 5 year unlimited kilometre warranty available on all brand new vehicles purchased from 1 August 2018. For full terms and conditions please visit <https://www.mazda.com.au/owners/warranty/> iPhone® is a trademark of Apple Inc., registered in the U.S. and other countries. Published September 2018. MAZ13756 126.034