

SUBARU
FORESTER
2019

**every moment
is a chance to do**



SUBARU



Find out more at [subaru.com.au/forester](https://www.subaru.com.au/forester)



Forester 2.5i-S AWD

every moment is a chance to do

Every moment you and your family spend in the all-new Subaru Forester is designed to be awesome.

Plenty of space, super comfortable seats, dual zone climate control, clever storage pockets and an upgraded touchscreen infotainment system make every drive more enjoyable. Your music, maps and contacts are right where you need them, thanks to Apple CarPlay® and Android Auto™ connectivity¹, so you can get stuff done on the go.

The new generation Forester is built on the all-new Subaru Global Platform which delivers a low centre of gravity, supreme stability, responsive steering control and a quieter cabin. This makes the ultimate family SUV safer to its core.

There's nothing more important than protecting your family, which is why every Forester also comes with EyeSight® Driver Assist technology, like a second pair of eyes looking out for you.

Make the most of every moment in the next generation Subaru Forester. Book a test drive today.

1. Compatible Apple® or Android™ device required.



Forester 2.5i AWD

packed with features

The all-new Subaru Forester helps you seize moments great and small – epic adventures, spontaneous trips and everyday life. You won't miss a thing with amazing visibility and reduced blind spots. Big windows and smart pillar design gives you outstanding visibility.

The Forester 2.5i AWD is loaded with amazing features like EyeSight® Driver Assist technology including Adaptive Cruise Control, an intuitive 6.5" touchscreen and thoughtful rear USB ports that can charge your passengers' devices. An array of new lighting features makes the Forester 2.5i AWD safer and more stylish, including Steering Responsive LED Headlights, LED tail lights and Daytime Running Lights.

Forester 2.5i AWD features

Performance

- + Symmetrical All-Wheel Drive (AWD)
- + 2.5-litre horizontally-opposed Boxer 4-cylinder, direct injection petrol engine
- + Lineartronic® CVT with manual mode
- + Maximum power output: 136kW@5800rpm
- + Maximum torque: 239Nm@4400rpm
- + X-Mode

Interior

- + 60/40 split folding rear seats
- + Air-conditioning – dual zone climate control with rear vents
- + Cloth seat trim – choice of black or platinum and black
- + Electronic parking brake
- + One touch lane change indicator
- + Paddle gear shifters
- + Reclining rear seat
- + Smart key and push-start ignition
- + USB charge port – rear passengers (x2)

+ Exterior

- + 17" alloy wheels
- + Daytime Running Lights – LED
- + Door mirrors with indicators – heated and power-folding
- + Front fog lights
- + LED tail lights
- + Push open fuel lid
- + Rain-sensing front windscreen wipers
- + Rear mud guards
- + Rear view reverse camera – with washer
- + Roof rails
- + Self-levelling LED headlights with auto off (dusk-sensing)
- + Steering Responsive Headlights (SRH)
- + Wheel arch mouldings

Entertainment/Technology

- + Bluetooth®¹ wireless technology
- + EyeSight® Driver Assist system featuring:
 - + Adaptive Cruise Control

- + Brake Light Recognition
- + Emergency Lane Keep Assist
- + Lane Departure Warning
- + Lane Keep Assist
- + Lane Sway Warning
- + Lead Vehicle Start Alert
- + Pre-Collision Brake Assist
- + Pre-Collision Braking System
- + Pre-Collision Throttle Management
- + Speed Limiter
- + Integrated infotainment system featuring:
 - + 6.5" LCD touchscreen
 - + Apple CarPlay® and Android Auto™ connectivity²
 - + Digital radio³ (DAB+)
 - + Siri®⁴ compatibility
- + Multi-Function Display unit (MFD) with 6.3" LCD screen
- + Multi-Information Display unit (MID)
- + Subaru's Vision Assist

1. Bluetooth® is a registered trademark of Bluetooth SIG Inc. System functionality is subject to the Bluetooth® wireless technology specification of individual device. 2. Compatible Apple® or Android™ device required. 3. Digital radio station coverage dependent on vehicle location. 4. Requires compatible Siri® enabled Apple® device to be paired with the infotainment system.

scans the road and your face

The Forester 2.5i-L AWD features Subaru's brand-new Driver Monitoring System - Driver Focus¹, which uses facial scanning technology to scan your face for signs of drowsiness and distraction. Every moment on the road is safer and easier with Adaptive Driving Beams, which automatically switch your headlights to low beam for oncoming traffic, and Reverse Automatic Braking which can detect obstacles in your way and apply the brakes to assist you from backing into them.

Forester 2.5i-L AWD features

Performance

- + Symmetrical All-Wheel Drive (AWD)
- + 2.5-litre horizontally-opposed Boxer 4-cylinder, direct injection petrol engine
- + Lineartronic[®] CVT with manual mode
- + Maximum power output: 136kW@5800rpm
- + Maximum torque: 239Nm@4400rpm
- + X-Mode

Interior

- + 60/40 split folding rear seats
- + Air-conditioning – dual zone climate control with rear vents
- + Cloth seat trim – choice of black or platinum and black
- + Electronic parking brake
- + One touch lane change indicator
- + Paddle gear shifters
- + Reclining rear seat
- + Smart key and push-start ignition
- + USB charge port – rear passengers (x2)

+ Exterior

- + 17" alloy wheels
- + Daytime Running Lights – LED
- + Door mirrors with indicators – heated and power-folding
- + Front fog lights
- + LED tail lights
- + Push open fuel lid
- + Rain-sensing front windscreen wipers
- + Rear mud guards
- + Rear view reverse camera – with washer
- + Roof rails
- + Self-levelling LED headlights with auto off (dusk-sensing)
- + Steering Responsive Headlights (SRH)
- + Wheel arch mouldings

Entertainment/Technology

- + *Bluetooth*^{®2} wireless technology

- + Driver Monitoring System - Driver Focus¹ featuring:
 - + Climate control setting (last used)
 - + Distraction warning
 - + Drowsiness warning
 - + Facial recognition
 - + MFD display (last used)
 - + MID display (last used)
- + EyeSight[®] Driver Assist system
- + Integrated infotainment system featuring:
 - + 6.5" LCD touchscreen
 - + Apple CarPlay[®] and Android Auto[™] connectivity³
 - + Digital radio⁴ (DAB+)
 - + Siri^{®5} compatibility
- + Multi-Function Display unit (MFD) with 6.3" LCD screen
- + Multi-Information Display unit (MID)
- + Subaru's Vision Assist

Scans the road and your face.
Explore the range at subaru.com.au/forester

1. Driver Monitoring System performance and capability dependent on environmental and technical conditions. Refer to Owner's Manual for full details. 2. *Bluetooth*[®] is a registered trademark of Bluetooth SIG Inc. System functionality is subject to the *Bluetooth*[®] wireless technology specification of individual device. 3. Compatible Apple[®] or Android[™] device required. 4. Digital radio station coverage dependent on vehicle location. 5. Requires compatible Siri[®] enabled Apple[®] device to be paired with the infotainment system.



FORESTER

Forester 2.5i-L AWD



Forester 2.5i Premium AWD

brimming with tech

The Subaru Forester 2.5i Premium AWD is sportier, more comfortable and brimming with tech to make every moment more fun. As well as sports pedals and 18" alloy wheels, Subaru Intelligent Drive technology lets you switch from Intelligent (I) mode to Sport (S) mode.

You'll get away quicker with a fast-powered rear tailgate, 8-way powered front seats, one touch folding rear seats, auto power-folding mirrors and an upgraded 8" LCD touchscreen with inbuilt satellite navigation. The new Driver Monitoring System¹ can recognise your face and instantly adjust the seat, mirrors and climate to your personal settings so you can take off at a moments notice.

Forester 2.5i Premium AWD features

Performance

- + Symmetrical All-Wheel Drive (AWD)
- + 2.5-litre horizontally-opposed Boxer 4-cylinder, direct injection petrol engine
- + Lineartronic[®] CVT with manual mode
- + Maximum power output: 136kW@5800rpm
- + Maximum torque: 239Nm@4400rpm
- + X-Mode

Interior

- + 60/40 split folding rear seats
- + 8-way power seats – driver and front passenger (driver with dual memory)
- + Air-conditioning – dual zone climate control with rear vents
- + Electronic parking brake
- + Paddle gear shifters
- + Premium cloth seat trim – choice of black or platinum and black
- + Smart key and push-start ignition
- + USB charge port – rear passengers (x2)

Exterior

- + 18" alloy wheels
- + Auto-dipping mirror – passenger side
- + Daytime Running Lights – LED
- + Door mirrors with indicators – heated and auto power-folding
- + Front fog lights
- + LED tail lights
- + Powered rear tailgate
- + Push open fuel lid
- + Rain-sensing front windscreen wipers
- + Rear mud guards
- + Rear view reverse camera – with washer
- + Self-levelling LED headlights with auto off (dusk-sensing)
- + Steering Responsive Headlights (SRH)
- + Wheel arch mouldings

Entertainment/Technology

- + *Bluetooth*^{®2} wireless technology

- + Driver Monitoring System¹ – Driver Focus featuring:
 - + Auto door mirror adjustment
 - + Auto driver's seat adjustment
 - + Climate control setting (last used)
 - + Distraction warning
 - + Drowsiness warning
 - + Facial recognition
 - + MFD display (last used)
 - + MID display (last used)
- + EyeSight[®] Driver Assist system
- + Integrated infotainment system featuring:
 - + 8" LCD touchscreen
 - + Apple CarPlay[®] and Android Auto[™] connectivity³
 - + Digital radio⁴ (DAB+)
 - + Satellite navigation
 - + Siri^{®5} compatibility
- + Multi-Function Display unit (MFD) with 6.3" LCD screen
- + Multi-Information Display unit (MID)
- + Subaru's Vision Assist

1. Driver Monitoring System performance and capability dependent on environmental and technical conditions. Refer to Owner's Manual for full details. 2. *Bluetooth*[®] is a registered trademark of Bluetooth SIG Inc. System functionality is subject to the *Bluetooth*[®] wireless technology specification of individual device. 3. Compatible Apple[®] or Android[™] device required. 4. Digital radio station coverage dependent on vehicle location. 5. Requires compatible Siri[®] enabled Apple[®] device to be paired with the infotainment system.

loaded with luxury

Step it up with the Forester 2.5i-S AWD. With leather¹ seat trim and a state of the art Harman Kardon^{®2} stereo to crank out more of the music you love. Plus, you'll make the most of every beautiful day with a super large electric sunroof.

Forester 2.5i-S AWD features

Performance

- + Symmetrical All-Wheel Drive (AWD)
- + 2.5-litre horizontally-opposed Boxer 4-cylinder, direct injection petrol engine
- + Lineartronic[®] CVT with manual mode
- + Maximum power output: 136kW@5800rpm
- + Maximum torque: 239Nm@4400rpm
- + X-Mode – 2 mode

Interior

- + 60/40 split folding rear seats
- + 8-way power seats – driver and front passenger (driver with dual memory)
- + Air-conditioning – dual zone climate control with rear vents
- + Electronic parking brake
- + Leather¹ seat trim – choice of black or platinum and black
- + One touch electric folding rear seats
- + One touch lane change indicator
- + Paddle gear shifters
- + Reclining rear seat
- + Smart key and push-start ignition
- + Sports pedals
- + USB charge port – rear passengers (x2)

Exterior

- + 18" alloy wheels
- + Auto-dipping mirror – passenger side
- + Chrome type window sills
- + Daytime Running Lights – LED
- + Door mirrors with indicators – heated and auto power-folding (silver)
- + Electric sunroof
- + Front fog lights – LED
- + LED tail lights
- + Powered rear tailgate
- + Push open fuel lid
- + Rain-sensing front windscreen wipers
- + Rear mud guards
- + Rear view reverse camera – with washer
- + Self-levelling LED headlights with auto off (dusk-sensing)
- + Steering Responsive Headlights (SRH)

Entertainment/Technology

- + 8 Harman Kardon^{®2} speakers, subwoofer and amplifier
- + Bluetooth^{®3} wireless technology

- + Driver Monitoring System⁴ – Driver Focus featuring:
 - + Auto door mirror adjustment
 - + Auto driver's seat adjustment
 - + Climate control setting (last used)
 - + Distraction warning
 - + Drowsiness warning
 - + Facial recognition
 - + MFD display (last used)
 - + MID display (last used)
- + EyeSight[®] Driver Assist system
- + Integrated infotainment system featuring:
 - + 8" LCD touchscreen
 - + Apple CarPlay[®] and Android Auto[™] connectivity⁵
 - + Digital radio⁶ (DAB+)
 - + Satellite navigation
 - + Siri^{®7} compatibility
- + Multi-Function Display unit (MFD) with 6.3" LCD screen
- + Multi-Information Display unit (MID)
- + Subaru's Vision Assist

Loaded with luxury.

Explore the range at subaru.com.au/forester

1. Some parts of the seating or trim are not full natural leather. 2. Harman Kardon[®] is a registered trademark of HARMAN International Industries, Incorporated. 3. Bluetooth[®] is a registered trademark of Bluetooth SIG Inc. System functionality is subject to the Bluetooth[®] wireless technology specification of individual device. 4. Driver Monitoring System performance and capability dependent on environmental and technical conditions. Refer to Owner's Manual for full details. 5. Compatible Apple[®] or Android[™] device required. 6. Digital radio station coverage dependent on vehicle location. 7. Requires compatible Siri[®] enabled Apple[®] device to be paired with the infotainment system.



Forester 2.5i-S AWD

why Forester?

Symmetrical force of power

Our All-Wheel Drive philosophy

Greater balance and control. That's the confidence you get from our unique Symmetrical All-Wheel Drive (AWD) system, which delivers the drive distribution to all four wheels, all the time. Every Subaru Forester has an innate sense of balance from the ground up, thanks to a near perfect symmetrical layout.

Boxing clever

Our famous Subaru Boxer engine

While most engines stand vertically, ours lay flat. The famous Subaru Boxer engine helps to deliver better handling. Sitting horizontally in the engine bay, it moves like a boxer's fists with a punch and counterpunch action. Lightweight, low and flat, it makes for perfect balance and a much lower centre of gravity. It creates less noise and vibration too. All of this means better on-road handling for you. More stability. More performance. More fun. And a more confident drive.

DataDotDNA®

Every Subaru is fitted with advanced engine immobilisers and the DataDotDNA®¹ Theft Deterrent System. Microscopic dots are laser-etched with each vehicle's unique Vehicle Identification Number – making it a less attractive target for thieves.

Three Year Rebate on Theft Insurance Excess

DataDot Technology (Australia) Pty Ltd will pay your theft insurance excess² (up to a maximum of \$800 including GST) should your new Subaru be stolen in the first three years of purchase and not recovered within 45 days despite the presence of DataDotDNA®¹ and warning labels.

The backbone of the future

Subaru Global Platform

The new generation Forester is built on the new Subaru Global Platform (SGP). Revolutionary Subaru engineering underpins the superior modular platform for enhanced performance, safety and drivability. Innovative to the core, the game changing frame delivers reduced vibration, less roll when cornering, a smoother ride

and improved overall road dynamics. The result? A drive that's damn near perfect and super smooth - with greater straight line stability, improved rigidity, responsive steering control and a quieter cabin.

Eyes in the back of your head

Rear view reverse camera

Manoeuvring back into a tight side street? Family driveway littered with toys? Reverse with confidence, thanks to our rear view reverse camera technology. The rear view reverse camera is like having eyes in the back of your head. This greatly improves your visibility and reduces the risk of bumps and scrapes. A rear view reverse camera is standard across the Subaru Forester range.

Efficiency without compromise

Auto Stop Start

We're constantly thinking of ways to help the environment and become more fuel-efficient. That's why we developed Auto Stop Start technology. It saves fuel by cutting the engine when you don't need it, like when you're idling or stopped in heavy

1. DataDotDNA® is a theft deterrent not a theft prevention mechanism. 2. Vehicles must be registered, comprehensively insured and less than 3 years old. DTA must receive a claim within 45 days of the theft. Terms and conditions apply.

traffic. The moment you're ready to move again, the engine restarts in a fraction of a second. Our Auto Stop Start technology is standard across the Subaru Forester range.

The eyes have it

Driver Monitoring System - Driver Focus¹

Using the facial recognition capabilities of the Driver Monitoring System – Driver Focus¹ the Forester can identify the driver as they take their seat – then can automatically adjust cabin settings to that driver's pre-programmed preferences. The individual preferences of up to five drivers can be stored, allowing the Multi-Function Display, instrument settings and climate control to be restored to the driver's last setting. While the driver's seat and door mirror positions are moved to the driver's personal settings on the 2.5i Premium AWD and 2.5i-S AWD variants.

Yet another world first

Lineartronic[®] CVT

Pushing innovation beyond the bounds, we introduced an automatic transmission called Lineartronic[®] Continuously Variable

Transmission (CVT). And it's the reason our automatic models drive so smooth. It's the world's first longitudinally mounted system for AWD vehicles. Unlike a conventional automatic transmission – which uses fixed gear ratios – our Lineartronic[®] CVT provides infinite variability between the highest and lowest available ratios. So you now experience a smoothness that also optimises the efficiency of the vehicle. For even more excitement, switch to manual mode for greater control to suit your driving style. Lineartronic[®] CVT is standard on all Forester variants.

Intelligently driven

Subaru Intelligent Drive

Heading to the shops? Taking on the Great Ocean Road? Each situation deserves a distinctive driving mode, so we crafted Subaru Intelligent Drive (SI-Drive) technology to do just that. Intelligent (I) mode – perfect for everyday driving and Sport (S) mode – for enhanced acceleration and all-round sport performance. SI-Drive is standard on Forester 2.5i Premium AWD and 2.5i-S AWD.

Get smart

X-Mode

When the going gets tough, engage Subaru's intelligent X-Mode, now standard across the Subaru Forester range. Featuring Hill Descent Control and improved grip and traction in low speed and slippery conditions, X-Mode delivers uncompromising performance in challenging terrain.

We're looking out for you

EyeSight[®] Driver Assist

We were the first car company to exclusively use stereo camera technology to detect objects in our vehicles path. A sign of our future-thinking and our commitment to quality, technology and safety, EyeSight[®] Driver Assist is like your second pair of eyes, spotting potentially dangerous situations. If EyeSight[®] detects anything that might be of danger, it warns you audibly, urging you to take action and brake. EyeSight[®] is now standard across the Subaru Forester range.

1. Driver Monitoring System - Driver Focus performance and capability dependent on environmental and technical conditions. Refer to Owner's Manual for full details. Excludes Subaru Forester 2.5i AWD variant.

get more done

Clever design, beautiful finishes and cutting-edge tech make the all-new Forester more enjoyable and productive. A large intuitive touchscreen connects to your phone using Apple CarPlay® and Android Auto™ connectivity¹, plus extra device charging ports in the back and plenty of legroom. A rear view reverse camera will also make it easier to get away safely.



USB charge ports – rear (x2)
All Forester variants



X-Mode (2 mode)
Forester 2.5i-S AWD



Steering wheel controls
Forester 2.5i Premium AWD and 2.5i-S AWD



Harman Kardon^{®2} speakers
Forester 2.5i-S AWD



1. Compatible Apple® or Android™ device required.
2. Harman Kardon® is a registered trademark of HARMAN International Industries, Incorporated.

be inspired

Interior

On the inside, choose from black or platinum/black cloth in the Forester 2.5i AWD and 2.5i-L AWD. Forester 2.5i Premium AWD features premium cloth interior in a choice of black or platinum/black. And for the range-topping Forester 2.5i-S AWD, sumptuous leather¹ is available in black or platinum/black.



Cloth
Black



Cloth
Platinum/Black

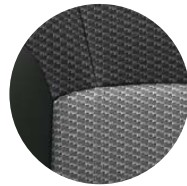

Premium Cloth
Black



Premium Cloth
Platinum/Black



Leather
Black



Leather
Platinum/Black

Exterior

The colour you choose for your Subaru makes a bold statement about who you are. So we've made sure you've got lots of ways to express yourself – with a wide range of colours to make your Subaru more...you.

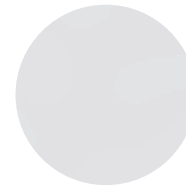

Crystal White
Pearl

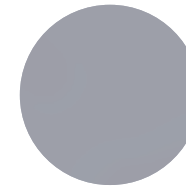

Ice Silver
Metallic

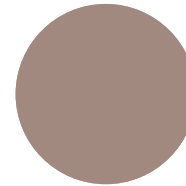

Sepia Bronze
Metallic

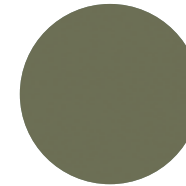

Jasper Green
Metallic

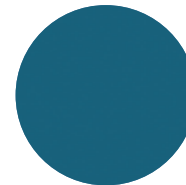

Horizon Blue
Pearl

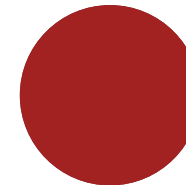

Crimson Red
Pearl

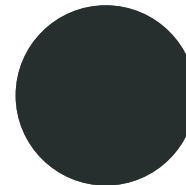

Dark Grey
Metallic

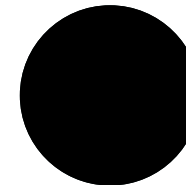

Crystal Black
Silica

Note: Paint colours are representative only and subject to variation due to the printing process.

1. Some parts of the seating or trim are not full natural leather.

Subaru Forester specifications¹

MODEL	2.5i AWD	2.5i-L AWD	2.5i Premium AWD	2.5i-S AWD
	SUV	SUV	SUV	SUV
Transmission				
Lineartronic® CVT with manual mode	•	•	•	•
Engine				
Bore x stroke	mm	94.0 x 90.0		
Capacity	cc	2498		
Compression ratio		12.0:1		
Engine type		Horizontally-opposed Boxer 4-cylinder, petrol engine		
Fuel requirement (min)	RON	91		
Fuel system		Direct injection		
Fuel tank capacity	litres	63		
Valve mechanism		DOHC with Dual AVCS		
Performance²				
CO ₂ emissions (ADR 81/02)	combined	(g/km)	168	
Electronic Throttle Control system (ETC)			Drive-by-wire	
Fuel consumption (ADR 81/02)	For comparison purposes only. Real world results may vary ³ :			
	combined	l/100km	7.4	
	urban	l/100km	9.3	
	extra urban	l/100km	6.3	
Maximum power output (DIN)	kW/rpm	136kW@5800rpm		
Maximum torque (DIN)	Nm/rpm	239Nm@4400rpm		
Symmetrical All-Wheel Drive (AWD)				
Type	Auto	Active Torque Split		
Transmission				
Final reduction gear ratio		3.900		
Gear ratio	1st	3.600		
	2nd	2.323		
	3rd	1.647		
	4th	1.241		
	5th	0.979		
	6th	0.746		
	7th	0.557		
Gear ratio – reverse		3.687		

1. Subaru Australia reserves the right to change mechanical specification and equipment levels without notice. 2. All performance data measured using 95RON test fuel as required by Australian Design Rule 81/02. Vehicles tested in accordance with ADR 81/02. 3. Fuel consumption figures quoted are measured in accordance with Australian Design Rule 81/02 and are for comparison purposes only. Real world results may vary based on individual driving circumstances e.g. traffic conditions, driving style, vehicle conditions, fuel quality, climatic conditions etc. Quoted figures may not reflect real world fuel consumption.

Subaru Forester specifications¹

MODEL		2.5i AWD	2.5i-L AWD	2.5i Premium AWD	2.5i-S AWD
Steering					
Minimum turning circle	m	10.8			
Type		Electric power assisted rack and pinion			
Suspension					
Type	Front	MacPherson struts, lower L-arms, coil springs, stabiliser bar			
	Rear	Double wishbone type, independent suspension			
Brakes					
ABS		4-channel, 4-sensor ABS with Electronic Brakeforce Distribution			
Brake booster type		Tandem			
Type	Front	Ventilated disc brake			
	Rear	Ventilated disc brake			
Wheels and Tyres					
Rim size		17x7J		18x7J	
Spare wheel		17"		18"	
Tyre manufacturer		Bridgestone		Bridgestone	
Tyres (width, profile, size, load index and speed rating)		225/60 R17 99V		225/55 R18 98V	
Wheels		17"		18"	
Measurement					
Cargo volume – rear seat up/down	litres	498/1768			
Front track	mm	1565			
Minimum ground clearance ²	mm	220			
Overall height	mm	1730			
Overall length	mm	4625			
Overall width	mm	1815			
Rear track	mm	1570			
Seating capacity		5			
Tare mass ³	kg	1523	1525	1546	1577
Wheel base	mm	2670			
Towing					
Maximum tow ball down load	kg	150			
Without trailer brakes (max)	kg	750			
With trailer brakes (max)	kg	1500			

1. Subaru Australia reserves the right to change mechanical specification and equipment levels without notice. 2. Ground clearance at kerb weight. 3. Vehicle tare mass varies according to the types of optional equipment included.

Subaru Forester features¹

MODEL	2.5i AWD	2.5i-L AWD	2.5i Premium AWD	2.5i-S AWD
Collision Avoidance				
Symmetrical All-Wheel Drive (AWD)	•	•	•	•
4-wheel disc brakes	•	•	•	•
Auto Vehicle Hold (AVH)	•	•	•	•
Driver Monitoring System – Driver Focus ² featuring:		•	•	•
Auto door mirror adjustment			•	•
Auto driver’s seat adjustment			•	•
Climate control setting (last used)		•	•	•
Distraction warning		•	•	•
Drowsiness warning		•	•	•
Facial recognition		•	•	•
MFD display (last used)		•	•	•
MID display (last used)		•	•	•
Electronic parking brake	•	•	•	•
Rear view reverse camera	•	•	•	•
Vehicle Dynamics Control system (VDC) featuring:	•	•	•	•
Active Torque Vectoring System	•	•	•	•
Anti-lock Braking System (ABS)	•	•	•	•
Brake Assist	•	•	•	•
Electronic Brakeforce Distribution (EBD)	•	•	•	•
Electronic Stability Control (ESC)	•	•	•	•
Traction Control System (TCS)	•	•	•	•
Vision Assist featuring:	•	•	•	•
Adaptive Driving Beam (ADB)		•	•	•
Blind Spot Monitor (BSM)	•	•	•	•
EyeSight® Assist Monitor	•	•	•	•
Front View Monitor (FVM)		•	•	•
Lane Change Assist (LCA)	•	•	•	•
Rear Cross Traffic Alert (RCTA)	•	•	•	•
Reverse Automatic Braking (RAB)		•	•	•
Side View Monitor (SVM)		•	•	•

1. Subaru Australia reserves the right to change mechanical specification and equipment levels without notice. 2. Driver Monitoring System - Driver Focus performance and capability dependent on environmental and technical conditions. Refer to Owner’s Manual for full details.

Subaru Forester features¹

MODEL	2.5i AWD	2.5i-L AWD	2.5i Premium AWD	2.5i-S AWD
Collision Protection				
3 point A/ELR rear seat belts	•	•	•	•
Front seat belts with pretensioners and load limiters	•	•	•	•
Height adjustable rear seat headrests for 3 seating positions	•	•	•	•
Height adjustable seat belt anchors – driver and front passenger	•	•	•	•
Height and angle adjustable front seat headrests	•	•	•	•
Seat belt warning lights – all seats	•	•	•	•
SRS ² airbags – dual front, dual front side, dual curtain and driver's knee	•	•	•	•
Child Safety				
Child seat anchor points (x3)	•	•	•	•
ISOFIX anchor points (x2)	•	•	•	•
Rear door child locks	•	•	•	•
Intelligent Driving Dynamics				
Auto Stop Start	•	•	•	•
Electronic Throttle Control system (ETC)	•	•	•	•
EyeSight [®] Driver Assist system featuring:	•	•	•	•
Adaptive Cruise Control	•	•	•	•
Brake Light Recognition	•	•	•	•
Emergency Lane Keep Assist	•	•	•	•
Lane Departure Warning	•	•	•	•
Lane Keep Assist	•	•	•	•
Lane Sway Warning	•	•	•	•
Lead Vehicle Start Alert	•	•	•	•
Pre-Collision Brake Assist	•	•	•	•
Pre-Collision Braking System	•	•	•	•
Pre-Collision Throttle Management	•	•	•	•
Speed Limiter	•	•	•	•
Subaru Intelligent Drive (SI-Drive) – 2 modes:			•	•
Intelligent (I) mode			•	•
Sport (S) mode			•	•
Tyre Pressure Monitoring System	•	•	•	•
X-Mode	•	•	•	2 mode

1. Subaru Australia reserves the right to change mechanical specification and equipment levels without notice. 2. SRS: Supplemental Restraint System. Effective when used in conjunction with seat belts.

Subaru Forester features¹

MODEL	2.5i AWD	2.5i-L AWD	2.5i Premium AWD	2.5i-S AWD
Exterior				
17" alloy wheels	•	•		
18" alloy wheels			•	•
Body coloured mirrors and door handles	•	•	•	Silver mirrors
Chrome type window sills			•	•
Detachable module type windscreen wipers	•	•	•	•
Door mirrors:	•	•	•	•
Auto-dipping (passenger side)			•	•
Heated	•	•	•	•
Indicators	•	•	•	•
Power-folding	•	•	Auto	Auto
Electric sunroof				•
Full size spare wheel	•	•	•	•
Privacy glass – rear door, rear quarter and rear windscreen	•	•	•	•
Rear mud guards	•	•	•	•
Rear spoiler	•	•	•	•
Rear window wiper	•	•	•	•
Reverse camera washer	•	•	•	•
Roof rails	•	•	•	Silver inserts
Shark fin antenna	•	•	•	•
Side cladding	•	•	•	Silver inserts
Tail pipe cover			•	•
Wheel arch mouldings	•	•	•	•
Lighting – Exterior				
Daytime Running Lights – LED	•	•	•	•
Front fog lights	•	•	•	LED
Headlights – dusk-sensing	•	•	•	•
Headlights – self-levelling LED with auto off	•	•	•	•
LED tail lights	•	•	•	•
Rear bumper reflectors	•	•	•	•
Rear combination lights	•	•	•	•
Rear LED stoplight	•	•	•	•
Steering Responsive Headlights (SRH)	•	•	•	•

1. Subaru Australia reserves the right to change mechanical specification and equipment levels without notice.

Subaru Forester features¹

MODEL	2.5i AWD	2.5i-L AWD	2.5i Premium AWD	2.5i-S AWD
Lighting – Interior				
Blue interior illumination	•	•	•	•
Cabin and cargo area lights	•	•	•	•
Map lights – LED (x2)	•	•	•	•
Air-conditioning				
Anti-dust filter	•	•	•	•
Dual zone climate control with rear vents	•	•	•	•
Floor heater ducts for rear passengers	•	•	•	•
Front and side demisters	•	•	•	•
Rear windscreen demister – electric	•	•	•	•
Security				
DataDotDNA ^{®2} security system	•	•	•	•
Immobiliser security system	•	•	•	•
Instrumentation and Controls				
Adjustable steering wheel - height and telescopic	•	•	•	•
Electroluminescent gauges with colour MID	•	•	•	•
Instrument cluster	•	•	•	•
Manual mode	•	•	•	•
One touch lane change indicator	•	•	•	•
Paddle gear shifters	•	•	•	•
Sports pedals			•	•
Steering wheel controls:	•	•	•	•
Audio	•	•	•	•
Bluetooth ^{®3}	•	•	•	•
EyeSight [®]	•	•	•	•
MFD	•	•	•	•
MID	•	•	•	•
SI-Drive			•	•
Twin trip meter (switchable)	•	•	•	•

1. Subaru Australia reserves the right to change mechanical specification and equipment levels without notice. 2. DataDotDNA[®] is a theft deterrent not a theft prevention mechanism. 3. Bluetooth[®] is a registered trademark of Bluetooth SIG Inc. System functionality is subject to the Bluetooth[®] wireless technology specification of individual device.

Subaru Forester features¹

MODEL	2.5i AWD	2.5i-L AWD	2.5i Premium AWD	2.5i-S AWD
Multi-Function Displays				
Multi-Function Display unit (MFD) featuring:	•	•	•	•
6.3" LCD screen	•	•	•	•
Air-conditioning display	•	•	•	•
Audio display	•	•	•	•
Driver Monitoring System ² (DMS) display		•	•	•
Electrical component operating condition display	•	•	•	•
EyeSight [®] display	•	•	•	•
Front View Monitor display		•	•	•
Fuel economy and journey information	•	•	•	•
Navigation display			•	•
Outside temperature and clock display	•	•	•	•
Preventative Safety display	•	•	•	•
Side View Monitor display		•	•	•
X-Mode display	•	•	•	•
Multi-Information Display unit (MID) featuring:	•	•	•	•
4.2" LCD screen	•	•	•	•
Auto Stop Start information	•	•	•	•
Bluetooth ^{®3} phone display	•	•	•	•
Digital speedometer	•	•	•	•
Eco-gauge display	•	•	•	•
EyeSight [®] display	•	•	•	•
Fuel economy and journey information	•	•	•	•
SI-Drive display			•	•
Tyre Pressure Monitoring System	•	•	•	•
Warning display	•	•	•	•
X-Mode display	•	•	•	•
Storage				
Cargo hooks	•	•	•	•
Cupholders – centre console	•	•	•	•
Cupholders – rear	•	•	•	•
Door pockets with integrated bottle holder – front and rear	•	•	•	•
Front centre tray	•	•	•	•

1. Subaru Australia reserves the right to change mechanical specification and equipment levels without notice. 2. Driver Monitoring System performance and capability dependent on environmental and technical conditions. Refer to Owner's Manual for full details. 3. Bluetooth[®] is a registered trademark of Bluetooth SIG Inc. System functionality is subject to the Bluetooth[®] wireless technology specification of individual device.

Subaru Forester features¹

MODEL	2.5i AWD	2.5i-L AWD	2.5i Premium AWD	2.5i-S AWD
Overhead console – sunglasses holder	•	•	•	•
Pull-out cargo area tie down points	•	•	•	•
Retractable cargo blind	•	•	•	•
Seat back pockets – driver and front passenger side	•	•	•	•
Convenience				
12V/120W power jacks (x3)	•	•	•	•
Boot/tailgate unlock on remote central locking keys	•	•	•	•
Intermittent variable speed front windscreen wipers	•	•	•	•
Power mirrors and windows – driver and front passenger window with auto function	•	•	•	•
Powered rear tailgate			•	•
Power steering	•	•	•	•
Push open fuel lid	•	•	•	•
Rain-sensing front windscreen wipers	•	•	•	•
Rear seat centre armrest	•	•	•	•
Remote central locking keys (x2)	•	•	•	•
Smart key and push-start ignition	•	•	•	•
Sunvisor extensions	•	•	•	•
Sunvisors with illuminated vanity mirrors – driver and front passenger	•	•	•	•
USB charge port – rear passengers (x2)	•	•	•	•
Interior Trims				
Cargo area carpet colour – black	•	•	•	•
Carpet trim – black	•	•	•	•
Leather ² steering wheel and gear shift	•	•	•	•
Seat trim – cloth	•	•	Premium cloth	
Seat trim colour – choice of black or platinum and black	•	•	•	•
Seat trim – leather ²				•
Shift boot	•	•	•	•
Seating Extras				
60/40 split folding rear seats	•	•	•	•
8-way power seat – front passenger			•	•
8-way power seat with dual memory – driver			•	•

1. Subaru Australia reserves the right to change mechanical specification and equipment levels without notice. 2. Some parts of the seating or trim are not full natural leather.

Subaru Forester features¹

MODEL	2.5i AWD	2.5i-L AWD	2.5i Premium AWD	2.5i-S AWD
Manual seat height lifter – driver	•	•		
One touch electronic folding rear seats			•	•
Reclining rear seat	•	•	•	•
Entertainment				
Auxiliary jack	•	•	•	•
Bluetooth ^{®2} wireless technology with:	•	•	•	•
Handsfree mobile communication	•	•	•	•
Audio streaming ³	•	•	•	•
Integrated infotainment system featuring:	•	•	•	•
6 speakers	•	•	•	
6.5" LCD touchscreen	•	•		
8 Harman Kardon ^{®4} speakers, subwoofer and amplifier				•
8" LCD touchscreen			•	•
AM/FM radio	•	•	•	•
Apple CarPlay [®] and Android Auto [™] connectivity ⁵	•	•	•	•
Digital radio ⁶ (DAB+)	•	•	•	•
Satellite navigation			•	•
Single CD player	•	•	•	•
Siri ^{®7} compatibility	•	•	•	•
USB connection(s) – front centre console	(x1)	(x1)	(x2)	(x2)
Voice command recognition	•	•	•	•
Owner Benefits				
5 Year/Unlimited Km Warranty	•	•	•	•
5 Year/62,500 Km Capped Price Servicing Program ⁸	•	•	•	•
12 Month Roadside Assistance Program ⁹	•	•	•	•

1. Subaru Australia reserves the right to change mechanical specification and equipment levels without notice. 2. Bluetooth[®] is a registered trademark of Bluetooth SIG Inc. System functionality is subject to the Bluetooth[®] wireless technology specification of individual device. 3. There may be restrictions on features available for certain models that are not fully compliant with AVCRP. 4. Harman Kardon[®] is a registered trademark of HARMAN International Industries, Incorporated. 5. Compatible Apple[®] or Android[™] device required. 6. Digital radio station coverage dependent on vehicle location. 7. Requires compatible Siri[®] enabled Apple[®] device to be paired with the infotainment system. 8. Every eligible Model Year 2019 onward Subaru Forester comes with Subaru's 5 Year/62,500 Km Capped Price Servicing Program. Available at participating Subaru Retailers only and does not apply to rental and some other classes of vehicles. For full Capped Price Servicing Terms and Conditions visit www.subaru.com.au/service/pricing/capped-price-servicing. 9. 12 Month Roadside Assistance Program is standard upon activation with relevant Motoring Club in each state. To receive this benefit the customer must opt into the 12 Month Roadside Assistance program at time of vehicle delivery. Eligible customers are those retail and novated lease customers who purchase a new Subaru on or after 1st June 2013 and have less than 5 vehicles under the Club Membership offer. Customers must provide a valid phone and residential address, as well as date of birth. Fleet, Government and Rental companies are excluded.



Forester 2.5i-S AWD

accessories for every adventure

We've got all the Genuine Subaru Accessories you need for your adventures. From bike and watercraft carriers to cargo pods, and a seat protector for the dogs. There's many ways to make your Subaru Forester fit you and your family even better.

- + Styling Tailor your Forester to your personal fit with a range of stylish interior and exterior options.
- + Protection Protect your Forester from a life of sandy feet, muddy paws and heavy luggage with a range of carpet or rubber mat sets, a cargo tray and a rear bumper cargo step panel.
- + Cargo and Tow To extend your Forester's towing and carrying capacity we offer a tow bar along with a broad range of Thule sport and cargo carrier accessories.
- + Security, Convenience and Safety Keep your new wheels secure with a security car alarm system. Park easily using Front Corner Parking Assist - sensors are automatically activated when reverse gear is engaged to guide you into tight spots.

Genuine Subaru Accessories are available from your Subaru Retailer, so be sure to ask about the range when buying your new Subaru Forester.

 To view our complete range of accessories and pricing online visit subaru.com.au/forester/accessories



packs that will inspire you

From action-packed to packing the back, these quality Genuine Subaru Accessory Packs will give you the protection you need and versatility you desire to do more of the good stuff.

Both stylish and functional, each Accessory Pack has been custom made for a tailored fit to complement your Subaru Forester and keep it looking good for years to come.

Plus all Genuine Subaru Accessories are protected by our manufacturer's warranty¹.

Protection Pack includes:

a Carpet Mat Set

Enjoy the comfort with a luxurious Subaru branded quality carpet mat set.

b Cargo Tray

Throw all the gear in the back with a heavy duty mat to protect the cargo area from dust and dirt.

c Cargo Step Panel (Resin)

Grab your gear and go without worrying about scratching the rear top face of the bumper with a tailored resin panel.

d Mud Guard Set (Front)

Help protect the sides of your Forester from nasty stone chips with tailor made Mud Guards.

e Weather Shields

Sleekly designed and tailored to fit on to each door individually.

Explorer Pack includes:

Add a Tow Bar to the Protection Pack to squeeze more out of your everyday.

f Tow Bar

Hook your toys up to a functional and sturdy tow bar engineered specifically for Subaru vehicles and designed for optimum performance.



Weather Shields
(Part Number F0010SJ000) shown



¹. For full warranty terms and conditions, visit subaru.com.au/accessories-information/warranty

protect your investment

Get out and do more while protecting your Subaru Forester from the rough and tumble of daily life. From our cargo tray to our bumper protector, each accessory is tailored for a perfect fit.

ACCESSORY		Part Number	2.5i AWD	2.5i-L AWD	2.5i Premium AWD	2.5i-S AWD
Styling						
1	Front Grille (Chrome)	J1010SJ100			•	•
2	Front Grille (Silver)	J1010SJ101	•	•		
3	Side Sill Plates	E1010SJ010	•	•	•	•
4	Bumper Under Guard (Rear) (Not applicable with Tow Bar)	E5510SJ000	•	•		
5	Centre Console Ultra Suede Side Trim	J1310SJ010	•	•	•	•
6	Ultra Suede Arm Rest	J1310SJ020	•	•	•	•
7	Front Dash Ultra Suede Trim Pieces	J1310SJ030	•	•	•	•
8	Centre Console Rose Gold Trim	J1310SJ110	•	•	•	•
Protection						
9	Carpet Mat Set	J501ASJ000	•	•	•	•
10	Rubber Mat Set	J5010SJ000	•	•	•	•
11	Weather Shields	F0010SJ000	•	•		
12	Weather Shields (Chrome)	F0010SJ010			•	•
13	Mud Guards Front	J1010SJ001	•	•	•	•
14	Cargo Step Panel (Stainless)	E7710SJ000	•	•	•	•
15	Cargo Step Panel (Resin)	E7710SJ010	•	•	•	•
16	Rear Seat Pet Protector	F4110SG000	•	•	•	•

To view our complete range of accessories and pricing online visit subaru.com.au/forester/accessories

	Not Applicable
•	Applicable



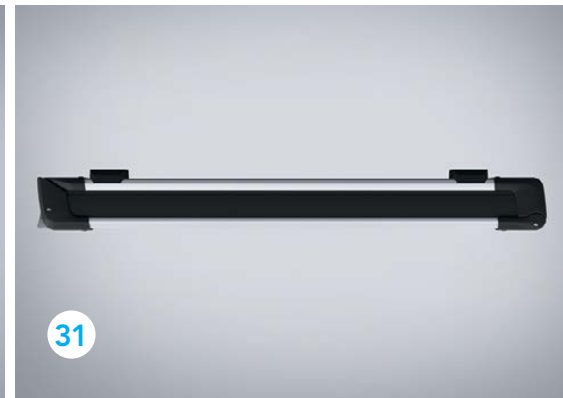
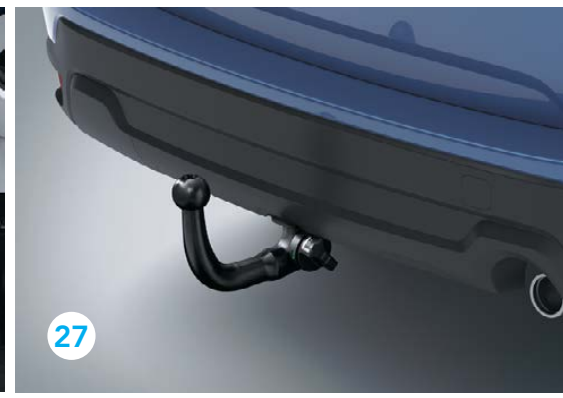
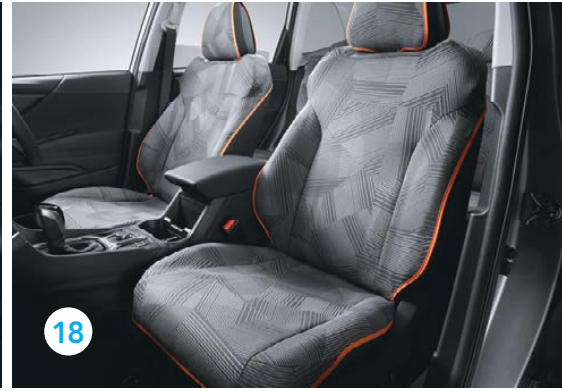

do all the things you've planned

Tow it, stow it or just pack more into your every day with a wide range of Subaru Forester compatible cargo options, plus premium Thule sport and cargo carrier accessories.

ACCESSORY	Part Number	2.5i AWD	2.5i-L AWD	2.5i Premium AWD	2.5i-S AWD
17 Front Black All Weather Seat Covers	F4110SJ000	•	•	•	•
18 Front Stripe All Weather Seat Covers	F4110SJ010	•	•	•	•
19 Rear Black All Weather Seat Cover	F4110SJ100	•	•	•	•
20 Rear Stripe All Weather Seat Cover	F4110SJ110	•	•	•	•
21 Bootlip and Bumper Protector	SAT6003	•	•	•	•
22 Headlamp Protectors	J101ASJ000	•	•	•	•

Cargo and Tow

23 Roof Cross Bars	E365ESG000	•	•	•	•
24 Cargo Tray Mat	J501ASJ100	•	•	•	•
25 Forester Cargo Net	F551SSJ000	•	•	•	•
26 Forester Cargo Barrier	F551ASJ000	•	•	•	•
27 Tow Bar	L101ASJ501	•	•	•	•
28 Lifestyle Awning Kit	SAT9020	•	•	•	•

Thule Roof Attachments and Accessories (Roof Cross Bars Required)

29 Xtender 6 Pair Ski Holder	SA1156	•	•	•	•
30 Deluxe Ski Carrier – 4 Pair	SAT8023	•	•	•	•
31 Deluxe Ski Carrier – 6 Pair	SAT8024	•	•	•	•
32 Bicycle Holder – Silver (Upright)	SAT8018	•	•	•	•

 To view our complete range of accessories and pricing online visit subaru.com.au/forester/accessories

ACCESSORY		Part Number	2.5i AWD	2.5i-L AWD	2.5i Premium AWD	2.5i-S AWD
Thule Roof Attachments and Accessories (Roof Cross Bars Required)						
33	Bicycle Holder – Black (Upright)	SAT8019	•	•	•	•
34	Bicycle Holder (Fork Mounted)	SA1042	•	•	•	•
35	Ski Holder – 4 Pair	SAT9012	•	•	•	•
36	Ski Holder – 6 Pair	SAT9013	•	•	•	•
37	Surfboard Carrier	SA1139	•	•	•	•
38	Kayak Carrier – Dockglide	SAT9018	•	•	•	•
39	Thule Paddleboard and Mal Carrier	SAT8016	•	•	•	•
40	Luggage Pod Touring 100 (Titan Aeroskin) Textured Finish (Small)	SAT5008	•	•	•	•
41	Luggage Pod Touring 100 (Black Glossy) Smooth Finish (Small)	SAT5008B	•	•	•	•
42	Luggage Pod Motion XT M (Glossy Silver)	SAT9014	•	•	•	•
43	Luggage Pod Motion XT M (Glossy Black)	SAT9015	•	•	•	•
44	Luggage Pod Motion XT XL (Glossy Silver)	SAT9016	•	•	•	•
45	Luggage Pod Motion XT XL (Glossy Black)	SAT9017	•	•	•	•
46	Thule Go Box	SAT8005	•	•	•	•
47	Thule Go Pack Set (4 Bags)	SAT8006	•	•	•	•
48	Side Up Wheel Step	SAT9004	•	•	•	•

 To view our complete range of accessories and pricing online visit subaru.com.au/forester/accessories



33



34

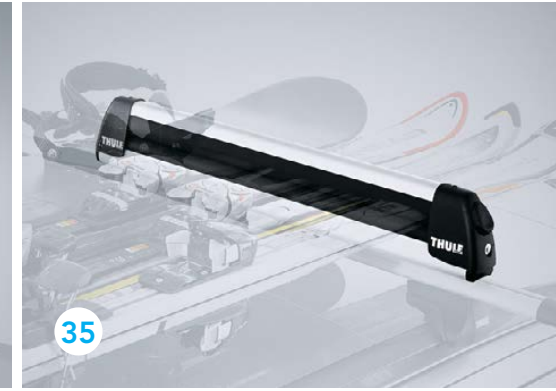

35



36



37



38



39



40



41



42



43

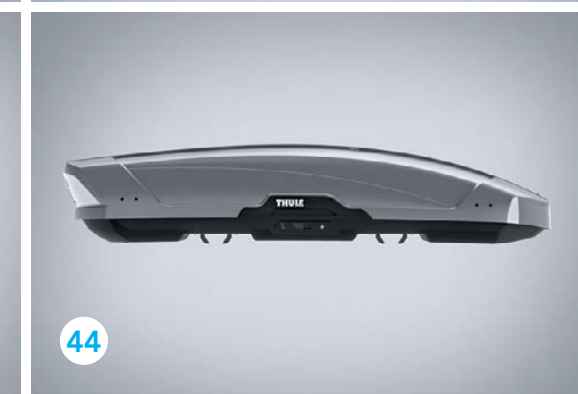

44



45



46



47



48

49



50



51



52



53



54



55



56



57



58



59



60



61



62



63



relax, we've thought of everything

From the simplest wheel lock nuts, to intelligent Front Corner Parking Assist, you can be sure we have you covered.

ACCESSORY	Part Number	2.5i AWD	2.5i-L AWD	2.5i Premium AWD	2.5i-S AWD
Security					
49 Wheel Lock Nuts	B327EYA000	•	•	•	•
Convenience and Safety					
50 Front Corner Parking Assist	H481ASJ000##	•	•	•	•
51 Cigarette Lighter	H6710AL010	•	•	•	•
52 Garbage Box	J2010FL020	•	•	•	•
53 First Aid Kit	PR7670	•	•	•	•
54 Safety Triangle	SAT9007	•	•	•	•
55 Garmin Dash Cam 55	0100175011	•	•	•	•
56 Magnetic Mount (additional)	0101253000	•	•	•	•
STI Performance Parts					
57 STI Shift Knob CVT	C1010SJ000	•	•	•	•
58 STI Alloy Wheel Set (4) – 18in (Silver)	B3110SJ000K	•	•	•	•
59 STI Alloy Wheel Set (4) – 18in (Gun Metal)	B3110SJ010K	•	•	•	•
60 STI Alloy Wheel Set (4) – 18in (Black)	B3110SJ020K	•	•	•	•
61 STI Alloy Wheel Set (4) – 17in (Silver)	B3110SJ100K	•	•	•	•
62 STI Alloy Wheel Set (4) – 17in (Gun Metal)	B3110SJ110K	•	•	•	•
63 STI Alloy Wheel Set (4) – 17in (Black)	B3110SJ120K	•	•	•	•

 To view our complete range of accessories and pricing online visit subaru.com.au/forester/accessories

Denotes colour option of your choice.





FORESTER

Forester 2.5i-S AWD

welcome to the family

There are cars that simply get you from A to B, and then there are cars that empower you. Buying a Subaru is like embracing life with both hands and knowing that nothing is going to stop you. When you buy a new Subaru you



are welcomed into an owner's program that gives you access to a number of benefits.

Subaru New Car Warranty – 5 Year/Unlimited Kilometres

Every new Subaru purchased on or after 1st January 2019 is covered by a 5 Year/Unlimited Kilometre manufacturer's national warranty. Visit subaru.com.au/warranty or ask your Subaru Retailer for more information.

Subaru Capped Price Servicing

With our 5 Year/62,500 Kilometre Capped Price Servicing Program¹, you'll now know the maximum amount you will have to pay for your next scheduled service during the Program

period. You'll also have peace of mind knowing that specialist Subaru technicians



will be looking after your pride and joy using only Genuine Subaru Parts.

DataDotDNA®

Every Subaru is fitted with advanced engine immobilisers and the DataDotDNA^{®2} Theft Deterrent System. Microscopic dots are laser-etched with each vehicle's unique Vehicle Identification Number – making it a less attractive target for thieves.

Three Year Rebate on Theft Insurance Excess

DataDot Technology (Australia) Pty Ltd will pay your theft insurance excess³ (up to a maximum of \$800 including GST) should your new Subaru be stolen in the first three years of purchase and not recovered within 45 days despite the presence of DataDotDNA^{®2} and warning labels.

1-Month Health Check and Chat

The 1-Month Health Check and Chat is a free consultation within the first month after delivery of your new Subaru. It allows our factory-trained technicians to provide quick vehicle checks, and one of our Service Advisors will answer any of your questions to help ensure an ongoing, worry-free experience.

Subaru's Map Updates

If your new Subaru is fitted with a factory line fit navigation unit your unit will be covered by Subaru's Map Update Program⁴ – guaranteeing you'll have access to the latest maps for the first 3 years of ownership.

My Subaru – online owner's destination

The My Subaru owner's portal is an online destination for owners which provides access to exclusive benefits, tailored content, your vehicle's ownership history and much more.

1. Every eligible Model Year 2019 onward Subaru Forester comes with Subaru's 5 Year/62,500 Km Capped Price Servicing Program. Available at participating Subaru Retailers only and does not apply to rental and some other classes of vehicles. For full Capped Price Servicing Terms and Conditions visit www.subaru.com.au/service/pricing/capped-price-servicing. 2. DataDotDNA[®] is a theft deterrent not a theft prevention mechanism. 3. Vehicles must be registered, comprehensively insured and less than 3 years old. DTA must receive a claim within 45 days of the theft. Terms and conditions apply. 4. Subaru's Map Update Program is available on MY19 Subaru Forester models purchased from September 9, 2018 onwards with the factory line fit Gen3.1 navigation unit. Subaru's Map Update Program is not available on accessory fit or dealer sourced navigation units. Subaru Australia reserves the right to add and remove eligible vehicles at its discretion. For full terms and conditions of the Subaru Map Update Program visit www.subaru.com.au/owner-experience/benefits/subaru-map-update-program.

live life without limits

Login to My Subaru, the online destination for Subaru owners that will help you get more out of your vehicle, and more out of your life. Visit my.subaru.com.au

Subaru Roadside Assistance

Enjoy 12 months of Australia-wide, standard Roadside Assistance when you purchase your new Subaru. In the unfortunate situation where you need that extra helping hand, our Roadside Assistance will help¹ with arranging a tow, battery service, flat tyre service, fuel delivery and lockout service.

Subaru Certified Collision Repairer Network

With a dedicated Subaru Certified Collision Repairer² helpline available on 1800 737 179, help is available when you need it most. Available 24-hours a day, 7 days a week, help is only a phone call away. Subaru Certified Collision Repairers guarantee that trained specialists will repair your Subaru to strict factory specifications using Genuine Subaru Parts.

Genuine Accessories

Genuine Subaru Accessories are designed to enhance your vehicle, help you get more stuff done and have more fun! Our genuine accessories are factory approved by Subaru and are protected by the Genuine Subaru Accessories Warranty. For our full range of Subaru Forester accessories visit subaru.com.au/forester/accessories. For warranty information visit subaru.com.au/warranty and click on "Genuine Subaru Accessories Warranty".

Subaru Finance

Subaru Finance³ provides a range of competitive financial solutions to approved customers. Our finance specialists will help you find a finance package to meet your needs conveniently.

Subaru Insurance

It's important to enjoy the freedom of owning a Subaru, but it's also important to protect it. A range of Subaru Insurance⁴ options provides a variety of choices, including: Subaru Comprehensive Motor Vehicle Insurance and Subaru Loan Protection Insurance.

Subaru Certified Used Cars

Every Subaru Certified Used Car has passed a 120-point quality inspection and comes with a one year unlimited kilometre Subaru Assured Warranty⁵ – to complement the balance of a new vehicle warranty or the statutory warranty that remains – from participating Subaru Certified Used Car Retailers.

1. 12 month Club Membership and Roadside Assistance Offer is standard upon activation with the relevant Motoring Club in each state. To receive this benefit the customer must opt into the 12 month Club Membership and Roadside Assistance Offer at time of vehicle delivery. Eligible customers are those retail and novated lease customers who purchase a new Subaru and have less than 5 vehicles under the Club Membership offer. Customers must provide a valid phone number and residential address, as well as date of birth. Fleet, Government and Rental companies are excluded. Terms and conditions apply. For a full list of benefits, visit www.subaru.com.au/owner-experience/benefits/program/roadside. 2. Subaru Certified Collision Repairer network not available in all areas. Call 1800 737 179 or visit www.subaru.com.au/retailers to find your closest Subaru Certified Collision Repairer. 3. Finance provided by Macquarie Leasing Pty Limited ABN 38 002 674 982 Australian Credit Licence Number 394925 trading as Subaru Finance. All applications for credit are subject to Macquarie's normal credit approval criteria. Terms and conditions, fees and charges apply. 4. Subaru Insurance products are issued by Allianz Australia Insurance Limited AFS Licence No. 234 708 ABN 15 000 122 850 (Allianz). In arranging this insurance Subaru (Aust) Pty Limited ABN 95 000 312 792 (Subaru) and the authorised dealers act as agents of Allianz and not as your agent. Neither Subaru nor any of its related companies or appointed authorised retailers have any liability in respect of these policies. 5. The Subaru Assured Warranty product is issued by the selling Subaru Retailer. Subaru Australia has no liability in respect of this warranty.

Forester Awards

- 2018 - Drive Car of the Year, Best Small SUV, Subaru Forester 2.5i-S AWD
- 2014 - Australia's Best Cars, Best AWD SUV Under \$45,000, Subaru Forester 2.5i
- 2013 - Australia's Best Cars, Best SUV Under \$45,000, Subaru Forester 2.5i
- 2013 - Australasian New Car Assessment Program 5 star ANCAP safety rating
- 2011 - Australia's best selling compact SUV, VFACTS 2008, 2009, 2010 and 2011
- 2009 - Best Compact SUV - Carsales Network People's Choice Award 2009, Subaru Forester
- 2008 - Best Compact SUV - Carsales Network People's Choice Award 2008, Subaru Forester
 - People's Choice Award - Drive 2008, Subaru Forester
 - Australasian New Car Assessment Program 5 star ANCAP safety rating for the entire Forester range
 - International Engine of the Year Award, 2.0 – 2.5-litre class, Subaru Forester XT (2.5-litre turbocharged horizontally-opposed Boxer engine)
- 2006 - Australia's Best Cars, Best Recreational 4WD, Subaru Forester X
 - International Engine of the Year Award, 2.0 – 2.5-litre class, Subaru Forester XT (2.5-litre turbocharged horizontally-opposed Boxer engine)
- 2004 - Australasian New Car Assessment Program 5 star ANCAP safety rating for the entire Forester range
 - Queensland Country Life, Queensland Country and Recreational Car of the Year, Subaru Forester 2.0XT
- 2003 - Australia's Best Cars, Best Recreational 4 Wheel Drive, Subaru Forester X
 - Australasian New Car Assessment Program 5 star ANCAP safety rating for the Forester XS Luxury (the best-ever rating for a compact ATW)
- 2002 - Australia's Best Cars, Best Recreational 4-Wheel Drive, Subaru Forester X
 - The Courier Mail, Queensland Car of the Year, Outstanding Recreational Vehicle, Subaru Forester X
- 2001 - Australia's Best Cars, Best Recreational Vehicle Under \$45,000, Subaru Forester Limited
 - The Courier Mail, Queensland Car of the Year, Outstanding Recreational Vehicle, Subaru Forester
- 2000 - Australia's Best Cars, Best Recreational Vehicle, Subaru Forester
 - 4x4 Australia, Best All-Wheel Drive, Subaru Forester
 - The Courier Mail, Queensland Car of the Year, Outstanding Recreational Vehicle, Subaru Forester
- 1999 - RACT Best Cars, TAS, Best Recreational Vehicle & Overall Winner, Subaru Forester
 - RACQ/The Courier Mail, QLD, Q-Car 1999, Best Recreational Vehicle & Overall Winner, Subaru Forester

Subaru Australia reserves the right to vary vehicle specifications and standard features in Australia from those detailed in this brochure. Vehicles shown in this brochure may be fitted with accessories available at additional cost. No part of the brochure can be reproduced without written permission from Subaru Australia. Printed in Australia.

subaru.com.au



SUBARU

© Copyright 2019 – Subaru (Aust) Pty Limited. All rights reserved.

Subaru (Aust) Pty Limited ABN 95 000 312 792 (Subaru Australia) PO Box 8311, Norwest NSW 2153 Toll Free: 1800 226 643