

SUBARU  
**IMPREZA**  
2019

**every moment  
is a chance to do**



**SUBARU**





Find out more at [subaru.com.au/impreza](https://subaru.com.au/impreza)





**Impreza 2.0i-S AWD Hatch**

## have it all

Spending time with friends is one of the best things about life. That's why you'll love the Subaru Impreza and your friends will too.

Loaded from head to toe with advanced driving and entertainment technology, it's fun for the driver and backseat ones too.

With an intuitive touchscreen infotainment system front and centre, you can swipe, pinch and tap to instantly play the music you love, access maps, messages and more via your smartphone and in-built Apple Carplay® and Android Auto™ connectivity<sup>1</sup>. Everything you love, right there at your fingertips.

With a sleek, modern exterior, it not only looks smart, Impreza thinks smart. The interior is better than ever too, with contemporary styling, high quality finishes and super comfortable seats.

Look closer and you'll see that many of the features you want come as standard, which we think makes Impreza one of the best value cars on the road. Add the 2.0-litre horizontally-opposed direct injection Boxer engine and life just gets better. Turning small car agility into big time fun, the Subaru Impreza is a car for doing all the things you love, with friends you love. Take it for a test drive today.

<sup>1</sup>. Compatible Apple® or Android™ device required.





Impreza 2.0i AWD Hatch

# raising small car standards

Some small cars miss the little things. Big on standard features, the Subaru Impreza 2.0i AWD doesn't skimp on premium cutting-edge technologies - they're built in, so you'll never feel compromised.

Apple CarPlay® and Android Auto™ connectivity<sup>1</sup>. Standard. Subaru's legendary Symmetrical All-Wheel Drive (AWD). Standard. Boxer engine performance. Standard. Digital radio<sup>2</sup> (DAB+). Standard. Auto Vehicle Hold to reduce driver fatigue by holding the vehicle in position when stopped. Standard.

Not to mention Auto Stop Start, USB ports, climate control air conditioning, an intuitive 6.5" LCD touchscreen infotainment system, Bluetooth®<sup>3</sup> wireless technology, 17" alloy wheels, power mirrors, power steering, a rear view reverse camera - you get the picture, they all come as standard.

## Impreza 2.0i AWD features

### Performance

- + Symmetrical All-Wheel Drive (AWD)
- + 2.0-litre horizontally-opposed Boxer 4-cylinder, direct injection petrol engine
- + Lineartronic® CVT with manual mode
- + Maximum power output: 115kW@6000rpm
- + Maximum torque: 196Nm@4000rpm

### Interior

- + 60/40 split folding rear seats
- + Air-conditioning – climate control
- + Cloth seat trim – choice of black or ivory
- + Electronic parking brake

- + Manual seat height lifter – driver
- + One touch lane change indicator
- + Paddle gear shifters
- + Smart key and push-start ignition
- + USB charge port – centre console (x2)

### Exterior

- + 17" alloy wheels
- + Body coloured mirrors and door handles
- + Halogen headlights with auto off
- + Rear spoiler (hatch)
- + Rear view reverse camera

### Entertainment/Technology

- + Bluetooth®<sup>3</sup> wireless technology
- + Cruise control
- + Integrated infotainment system featuring:
  - + 6.5" LCD touchscreen
  - + Apple CarPlay® and Android Auto™ connectivity<sup>1</sup>
  - + Digital radio<sup>2</sup> (DAB+)
  - + Siri®<sup>4</sup> compatibility
- + USB connection – front centre console

1. Compatible Apple® or Android™ device required. 2. Digital radio station coverage dependent on vehicle location. 3. Bluetooth® is a registered trademark of Bluetooth SIG Inc. System functionality is subject to the Bluetooth® wireless technology specification of individual device. 4. Requires compatible Siri® enabled Apple® device to be paired with the infotainment system.



# step things up

For even more of the amazing stuff, step into a Subaru Impreza 2.0i-L AWD or 2.0i Premium AWD. Enjoy the added safety and control of the EyeSight® Driver Assist system. EyeSight® features advanced preventative safety technologies, including Pre-Collision Brake Assist and Lane Keep Assist to help avoid accidents. Pure genius.

The more polished interior is pure premium, with leather steering wheel and gear shift. Pump up the volume with the 8" LCD touchscreen infotainment system and get all the info you need via a 6.3" Multi-Function Display unit, a Tyre Pressure Monitoring System (TPMS), and on the 2.0i Premium AWD, satellite navigation.

## Impreza 2.0i-L AWD features

### Performance

- + Symmetrical All-Wheel Drive (AWD)
- + 2.0-litre horizontally-opposed Boxer 4-cylinder, direct injection petrol engine
- + Lineartronic® CVT with manual mode
- + Maximum power output: 115kW@6000rpm
- + Maximum torque: 196Nm@4000rpm

### Interior

- + 60/40 split folding rear seats
- + Air-conditioning – dual zone climate control
- + Electronic parking brake
- + Leather steering wheel and gear shift
- + Manual seat height lifter – driver
- + One touch lane change indicator
- + Paddle gear shifters
- + Premium cloth seat trim – choice of black or ivory
- + Smart key and push-start ignition
- + Tyre Pressure Monitoring System (TPMS)
- + USB charge port – centre console (x2)

### Exterior

- + 17" alloy wheels
- + Body coloured door mirrors with indicators – power-folding
- + Daytime Running Lights - halogen
- + Front fog lights
- + Halogen headlights with auto off
- + Rear spoiler and rear window wiper (hatch)
- + Rear view reverse camera

### Entertainment/Technology

- + *Bluetooth*®<sup>1</sup> wireless technology
- + EyeSight® Driver Assist system featuring:
  - + Adaptive Cruise Control
  - + Brake Light Recognition
  - + Lane Departure Warning
  - + Lane Keep Assist
  - + Lane Sway Warning
  - + Lead Vehicle Start Alert
  - + Pre-Collision Brake Assist

- + Pre-Collision Braking System
- + Pre-Collision Throttle Management
- + Integrated infotainment system featuring:
  - + 8" LCD touchscreen
  - + Apple CarPlay® and Android Auto™ connectivity<sup>2</sup>
  - + Digital radio<sup>3</sup> (DAB+)
  - + Siri®<sup>4</sup> compatibility
- + Multi-Function Display unit (MFD) with 6.3" LCD screen
- + Multi-Information Display unit (MID)
- + USB connections – front centre console (x2)

## Impreza 2.0i Premium AWD extras

### Additional Features

- + Electric sunroof
- + Satellite navigation

Step things up.  
Explore the range at [subaru.com.au/impreza](http://subaru.com.au/impreza)

1. *Bluetooth*® is a registered trademark of Bluetooth SIG Inc. System functionality is subject to the *Bluetooth*® wireless technology specification of individual device. 2. Compatible Apple® or Android™ device required. 3. Digital radio station coverage dependent on vehicle location. 4. Requires compatible Siri® enabled Apple® device to be paired with the infotainment system.





Impreza 2.0i Premium AWD Sedan





**Impreza 2.0i-S AWD Hatch**



# the very best

Want next level? The Subaru Impreza 2.0i-S AWD comes with all the bells and whistles. Not only is it underpinned with the legendary ride and handling of Symmetrical All-Wheel Drive (AWD), Boxer engine performance and EyeSight® Driver Assist, it includes Subaru's Vision Assist technology, so you can say goodbye to life's curve balls and blind spots. Reverse Automatic Braking (RAB) can even stop you if there's an unexpected obstacle behind you. Amazing stuff.

## Impreza 2.0i-S AWD features

### Performance

- + Symmetrical All-Wheel Drive (AWD)
- + 2.0-litre horizontally-opposed Boxer 4-cylinder, direct injection petrol engine
- + Lineartronic® CVT with manual mode
- + Maximum power output: 115kW@6000rpm
- + Maximum torque: 196Nm@4000rpm

### Interior

- + 60/40 split folding rear seats
- + 8-way power seat – driver
- + Air-conditioning – dual zone climate control
- + Electronic parking brake
- + Heated front seats
- + Leather<sup>1</sup> seat trim – choice of black or ivory
- + Leather steering wheel and gear shift
- + One touch lane change indicator
- + Paddle gear shifters
- + Sports pedals
- + Smart key and push-start ignition
- + Tyre Pressure Monitoring System (TPMS)
- + USB charge port – centre console (x2)

### Exterior

- + 18" alloy wheels
- + Body coloured door mirrors with indicators – heated and power-folding
- + Chrome type door handles and window sills
- + Daytime Running Lights – LED
- + Electric sunroof
- + Front fog lights – LED
- + Rain-sensing front windscreen wipers
- + Rear spoiler (hatch)
- + Rear view reverse camera
- + Self-levelling LED headlights with auto off (dusk-sensing)
- + Side sill skirts
- + Steering Responsive Headlights (SRH)
- + Tail pipe cover (sedan)

### Entertainment/Technology

- + Bluetooth®<sup>2</sup> wireless technology
- + EyeSight® Driver Assist system featuring:
  - + Adaptive Cruise Control
  - + Brake Light Recognition

- + Lane Departure Warning
- + Lane Keep Assist
- + Lane Sway Warning
- + Lead Vehicle Start Alert
- + Pre-Collision Brake Assist
- + Pre-Collision Braking System
- + Pre-Collision Throttle Management
- + Integrated infotainment system featuring:
  - + 8" LCD touchscreen
  - + Apple CarPlay® and Android Auto™ connectivity<sup>3</sup>
  - + Digital radio<sup>4</sup> (DAB+)
  - + Satellite navigation
  - + Siri®<sup>5</sup> compatibility
- + Multi-Function Display unit (MFD) with 6.3" LCD screen
- + Multi-Information Display unit (MID)
- + Vision Assist featuring:
  - + Blind Spot Monitor (BSM)
  - + Lane Change Assist (LCA)
  - + Rear Cross Traffic Alert (RCTA)
  - + Reverse Automatic Braking (RAB)
- + USB connections – front centre console (x2)

1. Some parts of the seating or trim are not full natural leather. 2. Bluetooth® is a registered trademark of Bluetooth SIG Inc. System functionality is subject to the Bluetooth® wireless technology specification of individual device. 3. Compatible Apple® or Android™ device required. 4. Digital radio station coverage dependent on vehicle location. 5. Requires compatible Siri® enabled Apple® device to be paired with the infotainment system.



# why Impreza?

## Symmetrical force of power

### Our All-Wheel Drive philosophy

Greater balance and control. That's the confidence you get from our unique Symmetrical All-Wheel Drive (AWD) system, which delivers the drive distribution to all four wheels, all the time. Every Subaru Impreza has an innate sense of balance from the ground up, thanks to a near perfect symmetrical layout.

## Boxing clever

### Our famous Subaru Boxer engine

While most engines stand vertically, ours lay flat. The famous Subaru Boxer engine helps to deliver better handling. Sitting horizontally in the engine bay, it moves like a boxer's fists with a punch and counterpunch action. Lightweight, low and flat, it makes for perfect balance and a much lower centre of gravity. It creates less noise and vibration too. All of this means better on-road handling for you. More stability. More performance. More fun. And a more confident drive.

## DataDotDNA®

Every Subaru is fitted with advanced engine immobilisers and the DataDotDNA®<sup>1</sup> Theft Deterrent System. Microscopic dots are laser-etched with each vehicle's unique Vehicle Identification Number – making it a less attractive target for thieves.

### Three Year Rebate on Theft Insurance Excess

DataDot Technology (Australia) Pty Ltd will pay your theft insurance excess<sup>2</sup> (up to a maximum of \$800 including GST) should your new Subaru be stolen in the first three years of purchase and not recovered within 45 days despite the presence of DataDotDNA®<sup>1</sup> and warning labels.

## Finest safety

### 5 star ANCAP safety across the Impreza range

With spirit, quality and imagination comes some serious safety innovation. We want every Subaru Impreza to be amongst the safest cars on the road. Engineered full of cutting-edge technologies and the most intelligent

design features. The Subaru Impreza carries the maximum 5 star ANCAP<sup>3</sup> safety rating.

## The backbone of the future

### Subaru Global Platform

Built on the new Subaru Global Platform (SGP), Impreza is a new-generation small car which sets the benchmark.

Revolutionary Subaru engineering underpins the superior modular platform for enhanced performance, safety and drivability. Innovative to the core, the game changing frame delivers reduced vibration, less roll when cornering, a smoother ride and improved overall road dynamics.

The result? A drive that's damn near perfect and super smooth – with greater straight line stability, improved rigidity, more responsive steering control and a quieter cabin.

1. DataDotDNA® is a theft deterrent not a theft prevention mechanism. 2. Vehicles must be registered, comprehensively insured and less than 3 years old. DTA must receive a claim within 45 days of the theft. Terms and conditions apply. 3. The Australasian New Car Assessment Program (ANCAP) gives consumers consistent information on the level of occupant protection provided by vehicles in serious front and side crashes.



## Eyes in the back of your head

### Rear view reverse camera

Manoeuvring back into a tight side street? Family driveway littered with toys? Reverse with confidence, thanks to our rear view reverse camera technology. The rear view reverse camera is like having eyes in the back of your head. This greatly improves your visibility and helps reduce the risk of bumps and scrapes. The rear view reverse camera comes standard across the Impreza range.

## Efficiency without compromise

### Auto Stop Start

We're constantly thinking of ways to help the environment and become more fuel-efficient. That's why we developed Auto Stop Start technology. It saves fuel by immediately cutting the engine when you don't need it, like when you're idling or stopped in heavy traffic. The moment you're ready to move again, the engine restarts in a fraction of a second. Our Auto Stop Start technology is standard across the Impreza range.

## Yet another world first

### Lineartronic® CVT

Pushing innovation beyond the bounds, we introduced an automatic transmission called Lineartronic® Continuously Variable Transmission (CVT). And it's the reason our automatic models drive so smooth. It's the world's first longitudinally mounted system for AWD vehicles. Unlike a conventional automatic transmission – which uses fixed gear ratios – our Lineartronic® CVT provides infinite variability between the highest and lowest available ratios. So you now experience a smoothness that also optimises the efficiency of the vehicle. For even more excitement, switch to manual mode for greater control to suit your driving style. Lineartronic® CVT is standard across the Impreza range.

## We're looking out for you

### EyeSight® Driver Assist

We were the first car company to exclusively use stereo camera technology to detect objects in our vehicles path. A sign of our

future-thinking and our commitment to quality, technology and safety, EyeSight® Driver Assist is like your second pair of eyes, spotting potentially dangerous situations. If EyeSight® detects anything that might be of danger, it warns you audibly, urging you to take action and brake. EyeSight® Driver Assist is standard on Impreza 2.0i-L AWD, 2.0i Premium AWD and 2.0i-S AWD variants.

## Clever thinking

### Vision Assist

Imagine if your wing mirrors could alert you when there's something in your blind spot. Or if your car could detect the possibility of a collision whilst in reverse, and automatically apply the brakes. We made all this happen – and more – with Subaru's Vision Assist.

Our suite of proactive safety technologies including Blind Spot Monitor, Lane Change Assist, Rear Cross Traffic Alert and Reverse Automatic Braking are always at work to help you feel safer on the road. Subaru's Vision Assist technologies are standard on the Subaru Impreza 2.0i-S AWD.



# feel amazing inside

One of the features to love about a Subaru Impreza is the interior.

The quality of the finish is impressive to say the least. And it's packed with technologies to make every moment you spend behind the wheel a whole lot of fun.

Infotainment lets you enjoy more of the good stuff via the 6.5" or 8" LCD touchscreen, with Apple CarPlay® and Android Auto™ connectivity<sup>1</sup> at your fingertips. The smarts continue with satellite navigation on 2.0i Premium AWD and 2.0i-S AWD variants.



**Infotainment system**  
Impreza 2.0i AWD



**USB connectivity x2**  
Impreza 2.0i-L AWD, 2.0i Premium AWD and 2.0i-S AWD



**Multi-Function Display unit**  
2.0i-L AWD, 2.0i Premium AWD and 2.0i-S AWD



**Steering wheel controls**  
All Impreza variants

1. Compatible Apple® or Android™ device required.



# be inspired

## Interior

On the inside, choose from black or ivory cloth in the Subaru Impreza 2.0i AWD, Impreza 2.0i-L AWD and 2.0i Premium AWD variants feature premium cloth interior in a choice of black or ivory. And for the range-topping 2.0i-S AWD, sumptuous leather<sup>1</sup> is available in black or ivory.



**Leather**  
Black



**Leather**  
Ivory



**Premium Cloth**  
Black



**Premium Cloth**  
Ivory



**Cloth**  
Black



**Cloth**  
Ivory

## Exterior

Sleek and sophisticated, a Subaru Impreza looks stunning in a wide range of colours, the only question is which one is perfect for you?

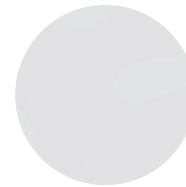

**Crystal White**  
Pearl

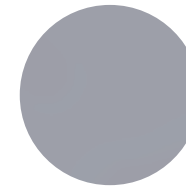

**Ice Silver**  
Metallic

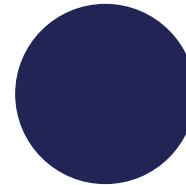

**Dark Blue**  
Pearl

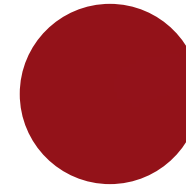

**Venetian Red**  
Pearl

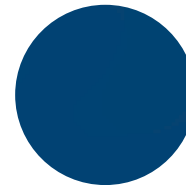

**Quartz Blue**  
Pearl

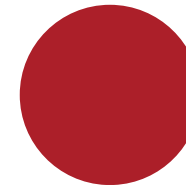

**Pure Red**

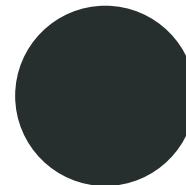

**Dark Grey**  
Metallic

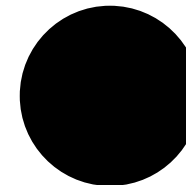

**Crystal Black**  
Silica

**Impreza**  
**2.0i-S AWD**

1. Some parts of the seating or trim are not full natural leather.

Note: Paint colours are representative only and subject to variation due to the printing process.



## Subaru Impreza specifications<sup>1</sup>

MODEL		2.0i AWD	2.0i-L AWD	2.0i Premium AWD	2.0i-S AWD
		Sedan/Hatch	Sedan/Hatch	Sedan/Hatch	Sedan/Hatch
<b>Transmission</b>					
Lineartronic® CVT with manual mode		•	•	•	•
<b>Engine</b>					
Bore x stroke	mm	84.0 x 90.0			
Capacity	cc	1995			
Compression ratio		12.5:1			
Engine type		Horizontally-opposed Boxer 4-cylinder, petrol engine			
Fuel requirement (min)	RON	90			
Fuel system		Direct injection			
Fuel tank capacity	litres	50			
Valve mechanism		DOHC with Dual AVCS			
<b>Performance<sup>2</sup></b>					
CO <sub>2</sub> emissions (ADR 81/02)	combined	(g/km)	152		163
Electronic Throttle Control system (ETC)			Drive-by-wire		
Fuel consumption (ADR 81/02) For comparison purposes only. Real world results may vary <sup>3</sup> :					
	combined	l/100km	6.6		7.2
	urban	l/100km	8.4		9.1
	extra urban	l/100km	5.6		6.1
Maximum power output (DIN)		kW/rpm	115kW@6000rpm		
Maximum torque (DIN)		Nm/rpm	196Nm@4000rpm		
<b>Symmetrical All-Wheel Drive (AWD)</b>					
Type		Auto	Active Torque Split		
<b>Transmission</b>					
Final reduction gear ratio			3.700		
Gear ratio		1st	3.600 (M Mode) / Continuously variable (CVT)		
		2nd	2.155 (M Mode) / Continuously variable (CVT)		
		3rd	1.516 (M Mode) / Continuously variable (CVT)		
		4th	1.092 (M Mode) / Continuously variable (CVT)		
		5th	0.843 (M Mode) / Continuously variable (CVT)		
		6th	0.667 (M Mode) / Continuously variable (CVT)		
		7th	0.557 (M Mode) / Continuously variable (CVT)		
Gear ratio – reverse			3.687		

1. Subaru Australia reserves the right to change mechanical specification and equipment levels without notice. 2. All performance data measured using 95RON test fuel as required by Australian Design Rule 81/02. Vehicles tested in accordance with ADR 81/02. 3. Fuel consumption figures quoted are measured in accordance with Australian Design Rule 81/02 and are for comparison purposes only. Real world results may vary based on individual driving circumstances e.g. traffic conditions, driving style, vehicle conditions, fuel quality, climatic conditions etc. Quoted figures may not reflect real world fuel consumption.

## Subaru Impreza specifications<sup>1</sup>

MODEL		2.0i AWD	2.0i-L AWD	2.0i Premium AWD	2.0i-S AWD
<b>Steering</b>					
Minimum turning circle	m	10.6			
Type		Electric power assisted rack and pinion			
<b>Suspension</b>					
Type	Front	MacPherson strut type, independent suspension			
	Rear	Double wishbone type, independent suspension			
<b>Brakes</b>					
ABS		4-channel, 4-sensor ABS with Electronic Brakeforce Distribution			
Brake booster type		Tandem			
Type	Front	Ventilated disc brake			
	Rear	Ventilated disc brake			
<b>Wheels and Tyres</b>					
Rim size		17x7J			18x7.5J
Spare wheel		Spacesaver spare wheel			
Tyre manufacturer		Bridgestone			Yokohama
Tyres (width, profile, size, load index and speed rating)		205/50R17 89V			225/40R18 92W
Wheels		17"			18"
<b>Measurement</b>					
Cargo volume – rear seat up / down	litres	Sedan - 460 / NA Hatch - 345 / 795			
Front track	mm	1540			
Minimum ground clearance <sup>2</sup>	mm	130			
Overall height	mm	Sedan - 1455 / Hatch - 1480			
Overall length	mm	Sedan - 4625 / Hatch - 4460			
Overall width	mm	1775			
Rear track	mm	1545			
Seating capacity		5			
Tare mass <sup>3</sup>	kg	1346 (Sedan) 1359 (Hatch)	1369 (Sedan) 1381 (Hatch)	1369 (Sedan) 1381 (Hatch)	1393 (Sedan) 1398 (Hatch)
Wheel base	mm	2670			
<b>Towing</b>					
Maximum tow ball down load	kg	120 (Hatch only)			
With trailer brakes (max)	kg	1200 (Hatch only)			
Without trailer brakes (max)	kg	650 (Hatch only)			

1. Subaru Australia reserves the right to change mechanical specification and equipment levels without notice. 2. Ground clearance at kerb weight. 3. Vehicle tare mass varies according to the types of optional equipment included.



## Subaru Impreza features<sup>1</sup>

MODEL	2.0i AWD	2.0i-L AWD	2.0i Premium AWD	2.0i-S AWD
<b>Safety Rating</b>				
5 star ANCAP <sup>2</sup> safety rating (maximum 5)	•	•	•	•
<b>Collision Avoidance</b>				
Symmetrical All-Wheel Drive (AWD)	•	•	•	•
4-wheel disc brakes	•	•	•	•
Auto Vehicle Hold (AVH)	•	•	•	•
Electronic parking brake	•	•	•	•
Rear view reverse camera	•	•	•	•
Vehicle Dynamics Control system (VDC) featuring:	•	•	•	•
Active Torque Vectoring System				•
Anti-lock Braking System (ABS)	•	•	•	•
Brake Assist	•	•	•	•
Electronic Brakeforce Distribution (EBD)	•	•	•	•
Electronic Stability Control (ESC)	•	•	•	•
Traction Control System (TCS)	•	•	•	•
Vision Assist featuring:				•
Blind Spot Monitor (BSM)				•
Lane Change Assist (LCA)				•
Rear Cross Traffic Alert (RCTA)				•
Reverse Automatic Braking (RAB)				•
<b>Collision Protection</b>				
3 point A/ELR rear seat belts	•	•	•	•
Front seat belts with pretensioners and load limiters	•	•	•	•
Height adjustable rear seat headrests for 3 seating positions	•	•	•	•
Height adjustable seat belt anchors – driver and front passenger	•	•	•	•
Height and angle adjustable front seat headrests	•	•	•	•
Ring-shaped passenger safety cell	•	•	•	•
Seat belt warning lights – all seats	•	•	•	•
SRS <sup>3</sup> airbags – dual front side, dual curtain and driver's knee	•	•	•	•
<b>Child Safety</b>				
Child seat anchor points (x3)	•	•	•	•
ISOFIX anchor points (x2)	•	•	•	•
Rear door child locks	•	•	•	•

1. Subaru Australia reserves the right to change mechanical specification and equipment levels without notice. 2. The Australasian New Car Assessment Program (ANCAP) gives consumers consistent information on the level of occupant protection provided by vehicles in serious front and side crashes. 3. SRS: Supplemental Restraint System. Effective when used in conjunction with seat belts.

## Subaru Impreza features<sup>1</sup>

MODEL	2.0i AWD	2.0i-L AWD	2.0i Premium AWD	2.0i-S AWD
<b>Intelligent Driving Dynamics</b>				
Auto Stop Start	•	•	•	•
Cruise control	•			
Electronic Throttle Control system (ETC)	•	•	•	•
EyeSight® Driver Assist system featuring:		•	•	•
Adaptive Cruise Control		•	•	•
Brake Light Recognition		•	•	•
Lane Departure Warning		•	•	•
Lane Keep Assist		•	•	•
Lane Sway Warning		•	•	•
Lead Vehicle Start Alert		•	•	•
Pre-Collision Brake Assist		•	•	•
Pre-Collision Braking System		•	•	•
Pre-Collision Throttle Management		•	•	•
Tyre Pressure Monitoring System (TPMS)	•	•	•	•
<b>Chassis and Mechanism</b>				
Front and rear stabiliser	•	•	•	•
<b>Exterior</b>				
17" alloy wheels	•	•	•	
18" alloy wheels				•
Body coloured door handles	•	•	•	
Body coloured rear garnish (Hatch)	•	•	•	•
Chrome type door handles and window sills				•
Detachable module type windscreen wipers	•	•	•	•
Door mirrors:	•	•	•	•
Body coloured	•	•	•	•
Heated				•
Indicators		•	•	•
Power-folding		•	•	•
Electric sunroof			•	•
Privacy glass – rear door and rear quarter (Sedan)	•	•	•	•
Privacy glass – rear door, rear quarter and rear windscreen (Hatch)	•	•	•	•
Rear spoiler (Hatch)	•	•	•	•
Rear window wiper (Hatch)	•	•	•	•
Roof carrier brackets (Hatch)	•	•	•	•

1. Subaru Australia reserves the right to change mechanical specification and equipment levels without notice.



## Subaru Impreza features<sup>1</sup>

MODEL	2.0i AWD	2.0i-L AWD	2.0i Premium AWD	2.0i-S AWD
Shark fin antenna	•	•	•	•
Side sill skirts				•
Spacesaver spare wheel	•	•	•	•
Tail pipe cover				Sedan
<b>Lighting – Exterior</b>				
Daytime Running Lights		Halogen	Halogen	LED
Front fog lights		•	•	LED
Headlights – halogen with auto off	•	•	•	
Headlights – self-levelling LED with auto off (dusk-sensing)				•
Rear bumper reflectors (Hatch)	•	•	•	•
Rear combination lights and Rear LED stoplight	•	•	•	•
Steering Responsive Headlights (SRH)				•
<b>Lighting – Interior</b>				
Blue interior illumination		•	•	•
Cabin and cargo area lights	•	•	•	•
Map lights (x2)	•	•	•	•
<b>Air-conditioning</b>				
Anti-dust filter	•	•	•	•
Climate control	•			
Dual zone climate control		•	•	•
Floor heater ducts for rear passengers	•	•	•	•
Front and side demisters	•	•	•	•
Rear windscreen demister – electric	•	•	•	•
<b>Security</b>				
DataDotDNA <sup>®2</sup> security system	•	•	•	•
Immobiliser security system	•	•	•	•
<b>Instrumentation and Controls</b>				
Adjustable steering wheel – height and telescopic	•	•	•	•
Electroluminescent gauges with colour MID		•	•	•
Hazard warning indicators	•	•	•	•
Instrument cluster	Standard	Premium	Premium	Premium
Manual mode	•	•	•	•
One touch lane change indicator	•	•	•	•
Paddle gear shifters	•	•	•	•
Sports pedals				•

1. Subaru Australia reserves the right to change mechanical specification and equipment levels without notice. 2. DataDotDNA<sup>®</sup> is a theft deterrent not a theft prevention mechanism.

## Subaru Impreza features<sup>1</sup>

MODEL	2.0i AWD	2.0i-L AWD	2.0i Premium AWD	2.0i-S AWD
Steering wheel controls:	•	•	•	•
Audio	•	•	•	•
Bluetooth <sup>®2</sup>	•	•	•	•
Cruise	•			
EyeSight <sup>®</sup>		•	•	•
MFD	•	•	•	•
MID		•	•	•
Twin trip meter (switchable)	•	•	•	•
<b>Multi-Function Displays</b>				
Multi-Function Display unit (MFD) featuring:	•	•	•	•
6.3" LCD screen		•	•	•
Air-conditioning display		•	•	•
Audio display		•	•	•
Auto Stop Start information	•			
Electrical component operating condition display		•	•	•
EyeSight <sup>®</sup> display		•	•	•
Fuel economy and journey information	•	•	•	•
Navigation display			•	•
Outside temperature and clock display	•	•	•	•
Preventative Safety display		•	•	•
Multi-Information Display unit (MID) featuring:		•	•	•
4.2" LCD screen		•	•	•
Auto Stop Start information		•	•	•
Digital speedometer		•	•	•
Eco-gauge display		•	•	•
EyeSight <sup>®</sup> display		•	•	•
Fuel economy and journey information		•	•	•
Tyre Pressure Monitoring System <sup>3</sup>		•	•	•
Warning display		•	•	•

1. Subaru Australia reserves the right to change mechanical specification and equipment levels without notice. 2. Bluetooth<sup>®</sup> is a registered trademark of Bluetooth SIG Inc. System functionality is subject to the Bluetooth<sup>®</sup> wireless technology specification of individual device. 3. Impreza 2.0i AWD TPMS features warning light only.



## Subaru Impreza features<sup>1</sup>

MODEL	2.0i AWD	2.0i-L AWD	2.0i Premium AWD	2.0i-S AWD
<b>Storage</b>				
Cargo hooks (Hatch)	•	•	•	•
Centre console box	•	With stitching	With stitching	With stitching
Cupholders – centre console and rear	•	•	•	•
Door pockets with integrated bottle holder – front and rear	•	•	•	•
Front centre tray	•	•	•	•
Pull-out cargo area tie down points (Hatch)	•	•	•	•
Retractable cargo blind (Hatch)	•	•	•	•
Seat back pocket – front passenger side	•	•	•	•
<b>Convenience</b>				
12V/120W power jacks (x2)	•	•	•	•
Boot/tailgate unlock on remote central locking keys	•	•	•	•
Interior fuel lid lock release	•	•	•	•
Intermittent variable speed front windscreen wipers	•	•	•	•
Power mirrors and windows – driver and front passenger window with auto function	•	•	•	•
Power steering	•	•	•	•
Rain-sensing front windscreen wipers				•
Rear seat centre armrest	•	•	•	•
Rear view mirror	•	•	•	•
Remote central locking keys (x2)	•	•	•	•
Smart key and push-start ignition	•	•	•	•
Sunvisors with illuminated vanity mirrors – driver and front passenger		•	•	•
Sunvisors with vanity mirrors – driver and front passenger	•			
USB charge port – centre console (x2)	•	•	•	•
<b>Interior Trims</b>				
Carpet trim – black	•	•	•	•
Gear shift surround	Silver	Piano Black	Piano Black	Piano Black
Leather steering wheel and gear shift		•	•	•
Seat trim – cloth	•	Premium cloth	Premium cloth	
Seat trim colour – choice of black or ivory	•	•	•	•
Seat trim – leather <sup>2</sup>				•
Shift boot		•	•	•

1. Subaru Australia reserves the right to change mechanical specification and equipment levels without notice. 2. Some parts of the seating or trim are not full natural leather.

## Subaru Impreza features<sup>1</sup>

MODEL	2.0i AWD	2.0i-L AWD	2.0i Premium AWD	2.0i-S AWD
<b>Seating Extras</b>				
60/40 split folding rear seats	•	•	•	•
8-way power seat – driver				•
Heated seats – driver and front passenger				•
Manual seat height lifter – driver	•	•	•	
<b>Entertainment</b>				
Auxiliary jack	•	•	•	•
Bluetooth <sup>®2</sup> wireless technology with:	•	•	•	•
Audio streaming <sup>3</sup>	•	•	•	•
Handsfree mobile communication	•	•	•	•
Integrated infotainment system featuring:	•	•	•	•
6 speakers	•	•	•	•
6.5" LCD touchscreen	•			
8" LCD touchscreen		•	•	•
AM/FM radio	•	•	•	•
Apple CarPlay <sup>®</sup> + Android Auto <sup>™</sup> connectivity <sup>4</sup>	•	•	•	•
Digital radio <sup>5</sup> (DAB+)	•	•	•	•
Satellite navigation			•	•
Single CD player	•	•	•	•
Siri <sup>®6</sup> compatibility	•	•	•	•
USB connection(s) – front centre console	(x1)	(x2)	(x2)	(x2)
Voice command recognition	•	•	•	•
<b>Owner Benefits</b>				
5 Year/Unlimited Km Warranty	•	•	•	•
5 Year/62,500 Km Capped Price Servicing Program <sup>7</sup>	•	•	•	•
12 Month Roadside Assistance Program <sup>8</sup>	•	•	•	•

1. Subaru Australia reserves the right to change mechanical specification and equipment levels without notice. 2. Bluetooth<sup>®</sup> is a registered trademark of Bluetooth SIG Inc. System functionality is subject to the Bluetooth<sup>®</sup> wireless technology specification of individual device. 3. There may be restrictions on features available for certain models that are not fully compliant with AVCRP. 4. Compatible Apple<sup>®</sup> or Android<sup>™</sup> device required. 5. Digital radio station coverage dependent on vehicle location. 6. Requires compatible Siri<sup>®</sup> enabled Apple<sup>®</sup> device to be paired with the infotainment system. 7. Every eligible Model Year 2018 onward Subaru Impreza comes with Subaru's 5 Year/62,500 Km Capped Price Servicing Program. Available at participating Subaru Retailers only and does not apply to rental and some other classes of vehicles. For full Capped Price Servicing Terms and Conditions visit [www.subaru.com.au/service/pricing/capped-price-servicing](http://www.subaru.com.au/service/pricing/capped-price-servicing). 8. 12 Month Roadside Assistance Program is standard upon activation with relevant Motoring Club in each state. To receive this benefit the customer must opt into the 12 Month Roadside Assistance program at time of vehicle delivery. Eligible customers are those retail and novated lease customers who purchase a new Subaru on or after 1st June 2013 and have less than 5 vehicles under the Club Membership offer. Customers must provide a valid phone and residential address, as well as date of birth. Fleet, Government and Rental companies are excluded.



# gear up for more fun

Throw something extra into the mix. With Genuine Subaru Accessories designed for all those things that make you tick. From bike carriers to cargo trays to tow bars and more. Pimp up your Impreza so you and your friends can get even more out of life.

- + Styling            Make your Impreza unmistakably yours with a range of stylish exterior options.
- + Protection        Keep your Impreza in pristine condition with a range of mat sets, a rear bumper protector and cargo tray.
- + Cargo              Get your Impreza ready to hit the highway with a wide range of quality Thule sport and cargo accessories, bike and kayak mounts.
- + Security, Convenience and Safety    Keep your new wheels secure with a set of wheel lock nuts. To help take the stress away with parking in tight spaces we offer front corner and reverse parking sensors.

Genuine Subaru Accessories are available from your Subaru Retailer, so be sure to ask about the range when buying your new Subaru Impreza.



To view our complete range of accessories and pricing online visit [subaru.com.au/impreza/accessories](http://subaru.com.au/impreza/accessories)



# packs that will inspire you

From action-packed to packing the back, these quality Genuine Subaru Accessory Packs will give you the protection you need and versatility you desire to do more with your Subaru Impreza.

Both stylish and functional, each Accessory Pack has been custom made for a tailored fit to complement your Impreza and keep it looking good for years to come.

Plus all Genuine Subaru Accessories are protected by our manufacturer's warranty<sup>1</sup>.

## Protection Pack includes:

### a Bootlip and Bumper Protector

Grab your gear and go without worrying about scratching the rear bumper with a tailored bootlip and bumper protector.

### b Carpet Mat Set

Enjoy the comfort with a luxurious Subaru branded quality carpet mat set.

### c Cargo Tray

Throw all the gear in the back with a heavy duty mat to protect the cargo area from dust and dirt.

### d Weather Shields

Sleekly designed and tailored to fit onto each door individually.

## Explorer Pack<sup>2</sup> includes:

Add a tow bar to the Protection Pack to squeeze more out of your everyday.

### e Tow Bar

Hook your toys up to a functional and sturdy tow bar engineered specifically for the Australian market.



a



b

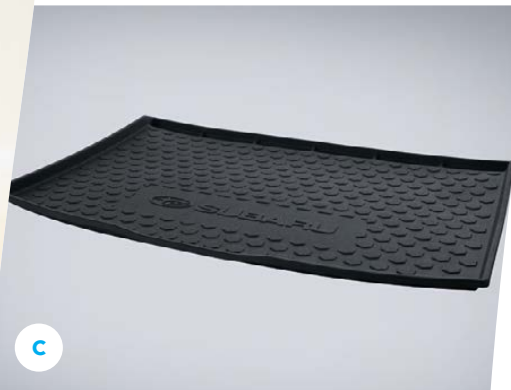

c



d

1. For full warranty terms and conditions, visit [subaru.com.au/accessories-information/warranty](http://subaru.com.au/accessories-information/warranty)  
2. Explorer Pack only applicable to Subaru Impreza Hatch variants.

# protect your investment

Get out and do more while protecting your Impreza from the rough and tumble of daily life. From cargo trays to bumper protectors, each accessory is tailored for a perfect fit.

ACCESSORY	Part Number	Body Type	2.0i AWD	2.0i-L AWD	2.0i Premium AWD	2.0i-S AWD
<b>Styling</b>						
1 Side Sill Plate (Subaru)	E1010FJ100	Sedan and Hatch	•	•	•	•
2 Side Strake Set <sup>1</sup>	E2610FL000NN	Sedan and Hatch				•
3 Front Grille	J1010FL300	Sedan and Hatch	•	•	•	•
4 Rear Bumper Panel	E5510FL000	Sedan	•	•	•	•
5 Rear Bumper Panel	E5510FL010	Hatch	•	•	•	•
<b>Protection</b>						
6 Weather Shields	F0010FL000	Sedan	•	•	•	•
7 Weather Shields	F0010FL010	Hatch	•	•	•	•
8 Mud Guards (Front)	J1010FL001NN	Sedan and Hatch	•	•	•	
9 Mud Guards (Rear)	J1010FL004NN	Sedan	•	•	•	•
10 Mud Guards (Rear)	J1010FL104NN	Hatch	•	•	•	•
11 Aero Splash Guards (Set)	J1010FL500NN	Sedan				•
12 Aero Splash Guards (Set)	J1010FL600NN	Hatch				•
13 Carpet Mat Set	J501AFL000	Sedan and Hatch	•	•	•	•
14 Rubber Mat Set	J5010FL100	Sedan and Hatch	•	•	•	•

1. Includes painting in RRP Fitted Price.



To view our complete range of accessories and pricing online visit [subaru.com.au/impreza/accessories](http://subaru.com.au/impreza/accessories)

•

Not Applicable  
Applicable







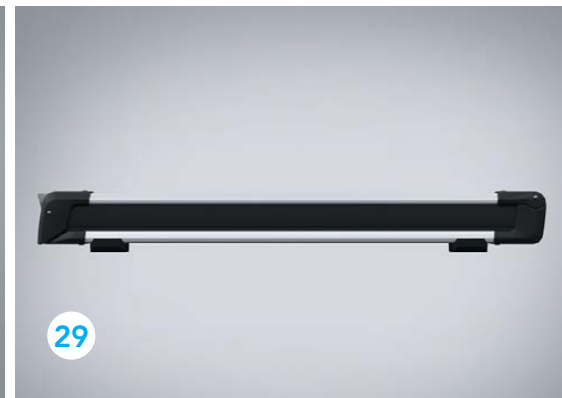
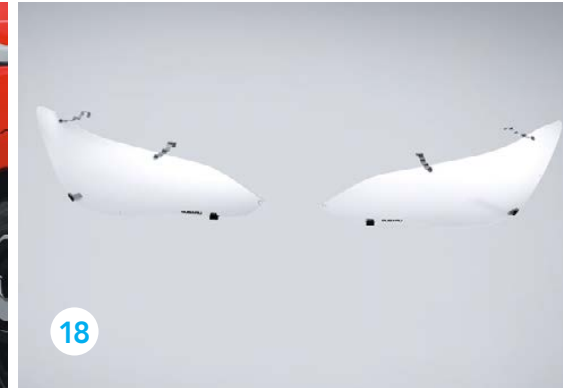

# do all the things you've planned

Tow it, stow it or just pack more into your every day with a wide range of Impreza compatible cargo options, plus premium Thule sport and cargo carrier accessories.

ACCESSORY	Part Number	Body Type	2.0i AWD	2.0i-L AWD	2.0i Premium AWD	2.0i-S AWD
<b>Protection</b>						
15 All Weather Seat Cover – Front <sup>1</sup>	F4110FL000	Sedan and Hatch	•	•	•	
16 All Weather Seat Cover – Rear <sup>1</sup>	F4110FL010	Sedan and Hatch	•	•	•	
17 Body Side Moulding (Non-coloured)	J1010VA600NN	Sedan and Hatch	•	•	•	•
18 Head Lamp Protectors	J101AFL000	Sedan and Hatch	•	•	•	•
19 Cargo Step Panel (Stainless)	E7710FL000	Hatch	•	•	•	•
20 Bootlip and Bumper Protector	SAT6003	Sedan and Hatch	•	•	•	•
21 Door Edge Moulding – Silver (2 required) <sup>2</sup>	F0070YA001	Sedan and Hatch	•	•	•	•
<b>Cargo and Tow</b>						
22 Roof Cross Bars	SAT3017	Sedan	•	•	•	•
23 Roof Cross Bars	SAT3018	Hatch	•	•	•	•
24 Cargo Tray	J501AFL100	Sedan	•	•	•	•
25 Cargo Tray	J501AFL110	Hatch	•	•	•	•
26 Tow Bar <sup>3</sup>	L101AFL000	Hatch	•	•	•	•
<b>Thule Roof Attachments and Accessories (Roof Cross Bars Required)</b>						
27 Xtender 6 Pair Ski Holder	SA1156	Sedan and Hatch	•	•	•	•
28 Deluxe Ski Carrier – 4 Pair	SAT8023	Sedan and Hatch	•	•	•	•
29 Deluxe Ski Carrier – 6 Pair	SAT8024	Sedan and Hatch	•	•	•	•

1. Not applicable for leather seats. 2. Door Edge Moulding also available in white, dark silver, black, red, blue, dark blue and dark green.  
3. Tow bar only applicable to Subaru Impreza Hatch variants.

 To view our complete range of accessories and pricing online visit [subaru.com.au/impreza/accessories](http://subaru.com.au/impreza/accessories)



ACCESSORY		Part Number	Body Type	2.0i AWD	2.0i-L AWD	2.0i Premium AWD	2.0i-S AWD
<b>Thule Roof Attachments and Accessories (Roof Cross Bars Required)</b>							
30	Bicycle Holder – Silver (Upright)	SAT8018	Sedan and Hatch	•	•	•	•
31	Bicycle Holder – Black (Upright)	SAT8019	Sedan and Hatch	•	•	•	•
32	Bicycle Holder (Fork Mounted)	SA1042	Sedan and Hatch	•	•	•	•
33	Ski Holder – 4 Pair	SAT9012	Sedan and Hatch	•	•	•	•
34	Ski Holder – 6 Pair	SAT9013	Sedan and Hatch	•	•	•	•
35	Surfboard Carrier	SA1139	Sedan and Hatch	•	•	•	•
36	Kayak Carrier – DockGlide	SAT9018	Sedan and Hatch	•	•	•	•
37	Thule Paddleboard & Mal Carrier	SAT8016	Sedan and Hatch	•	•	•	•
<b>Thule Roof Attachments and Accessories (Roof Cross Bars Required)</b>							
38	Luggage Pod Touring 100 (Titan Aeroskin) Textured Finish (Small)	SAT5008	Sedan and Hatch	•	•	•	•
39	Luggage Pod Touring 100 (Black Glossy) Smooth Finish (Small)	SAT5008B	Sedan and Hatch	•	•	•	•
40	Luggage Pod Motion XT M (Glossy Silver)	SAT9014	Sedan and Hatch	•	•	•	•
41	Luggage Pod Motion XT M (Glossy Black)	SAT9015	Sedan and Hatch	•	•	•	•
42	Luggage Pod Motion XT XL (Glossy Silver)	SAT9016	Sedan and Hatch	•	•	•	•
43	Luggage Pod Motion XT XL (Glossy Black)	SAT9017	Sedan and Hatch	•	•	•	•
44	Thule Go Box	SAT8005	Sedan and Hatch	•	•	•	•

 To view our complete range of accessories and pricing online visit [subaru.com.au/impreza/accessories](https://subaru.com.au/impreza/accessories)

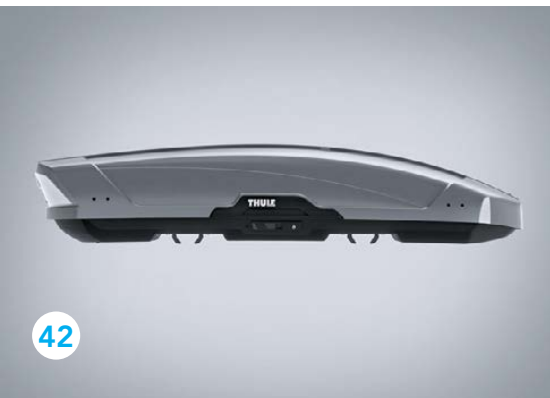
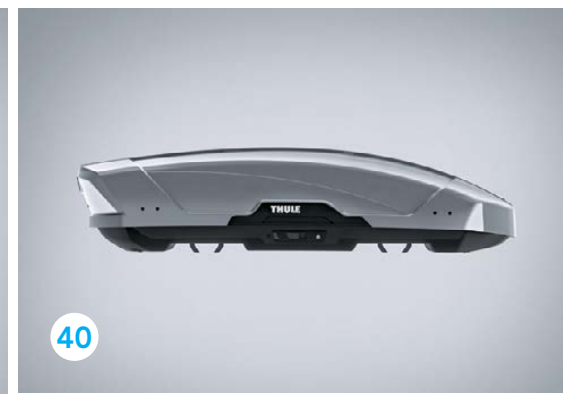
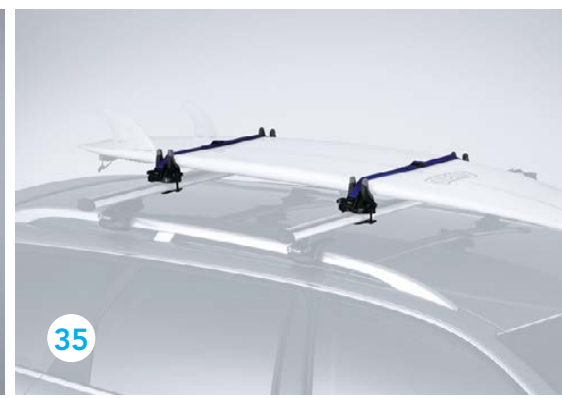
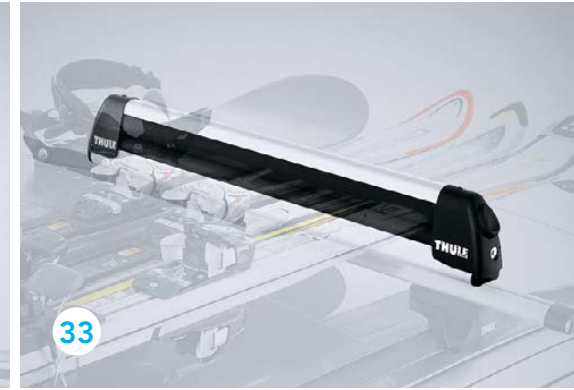





# relax, we've thought of everything

From the simplest wheel lock nuts, to intelligent front corner and reverse parking sensors, you can be sure we have you covered.

ACCESSORY	Part Number	Body Type	2.0i AWD	2.0i-L AWD	2.0i Premium AWD	2.0i-S AWD
45 Thule Go Pack Set (4 Bags)	SAT8006	Sedan and Hatch	•	•	•	•
46 Side Wheel Step Up	SAT9004	Sedan and Hatch	•	•	•	•
<b>Tow Bar Attachments (Tow Bar Required)</b>						
47 Tow Bar Mounted Bike Carrier (Two Bikes)	SAP925	Hatch	•	•	•	•
48 Tow Bar Mounted Bike Carrier (Three Bikes)	SAP927	Hatch	•	•	•	•
<b>Security</b>						
49 Wheel Lock Nuts	B327EYA000	Sedan and Hatch	•	•	•	•
<b>Convenience and Safety</b>						
50 Front Corner Parking Sensors	H481AFL000##	Sedan and Hatch	•	•	•	•
51 Reverse Sensors <sup>1</sup>	H481AFL100##	Sedan	•	•	•	
52 Reverse Sensors <sup>1</sup>	H481AFL200##	Hatch	•	•	•	
53 CTR Console Tray	J2010FL000	Sedan and Hatch	•	•	•	•
54 Garbage Box	J2010FL010	Sedan and Hatch	•	•	•	•
55 First Aid Kit	PR7670	Sedan and Hatch	•	•	•	•
56 Safety Triangle	SAT9007	Sedan and Hatch	•	•	•	•
57 Garmin Dash Cam 55	0100175011	Sedan and Hatch	•	•	•	•
58 Magnetic Mount (additional)	0101253000	Sedan and Hatch	•	•	•	•
59 Fog Lamp Kit	H4510FL010	Sedan and Hatch	•			

## Denotes colour option of your choice. 1. Reverse sensors suitable for all variants except Impreza 2.0i-S AWD.

 To view our complete range of accessories and pricing online visit [subaru.com.au/impreza/accessories](http://subaru.com.au/impreza/accessories)

# kick it into overdrive

Show your allegiance with bold, branded accessories to protect and style your new Subaru Impreza.

ACCESSORY	Part Number	Body Type	2.0i AWD	2.0i-L AWD	2.0i Premium AWD	2.0i-S AWD
<b>STI Performance Parts</b>						
60 STI Front Under Spoiler	E2410FL000	Sedan and Hatch	•	•	•	•
61 STI Side Under Spoiler <sup>1</sup>	E2610FL010	Sedan and Hatch				•
62 STI Roof Spoiler	E7210FL100	Hatch	•	•	•	•
63 STI Rear Side Under Spoiler	E5610FL000	Sedan	•	•	•	•
64 STI Boot Spoiler (Black)	E7210FL000	Sedan	•	•	•	•
65 STI Shift Knob CVT	C1010FL000	Sedan and Hatch	•	•	•	•
66 STI Flexible Tower Bar	E4010FL000	Sedan and Hatch	•	•	•	•
67 STI ENKEI Alloy Wheel Set (4) – 17 inch (Silver)	B3110FL200K	Sedan and Hatch	•	•	•	
68 STI ENKEI Alloy Wheel Set (4) – 17 inch (Gun Metal)	B3110FL210K	Sedan and Hatch	•	•	•	
69 STI ENKEI Alloy Wheel Set (4) – 17 inch (Black)	B3110FL220K	Sedan and Hatch	•	•	•	
70 STI ENKEI Alloy Wheel Set (4) – 18 inch (Silver)	B3110FL100K	Sedan and Hatch				•
71 STI ENKEI Alloy Wheel Set (4) – 18 inch (Gun Metal)	B3110FL110K	Sedan and Hatch				•
72 STI ENKEI Alloy Wheel Set (4) – 18 inch (Black)	B3110FL120K	Sedan and Hatch				•

1. Cannot be used in conjunction with front Aero Splash Guard and Side Strake Set as they will impede the fitment of this item to the vehicle.

 To view our complete range of accessories and pricing online visit [subaru.com.au/impreza/accessories](http://subaru.com.au/impreza/accessories)



60



61



62



63



64



65



66



67



68



69



70



71



72





# welcome to the family

There are cars that simply get you from A to B, and then there are cars that empower you. Buying a Subaru is like embracing life with both hands and knowing that nothing is going to stop you. When you buy a new Subaru you



are welcomed into an owner's program that gives you access to a number of benefits.

## Subaru New Car Warranty – 5 Year/Unlimited Kilometres

Every new Subaru purchased on or after 1st January 2019 is covered by a 5 Year/Unlimited Kilometre manufacturer's national warranty. Visit [subaru.com.au/warranty](http://subaru.com.au/warranty) or ask your Subaru Retailer for more information.

## Subaru Capped Price Servicing

With our 5 Year/62,500 Kilometre Capped Price Servicing Program<sup>1</sup>, you'll now know the maximum amount you will have to pay for your next scheduled service during the Program

period. You'll also have peace of mind knowing that specialist Subaru technicians will be looking after your pride and joy using only Genuine Subaru Parts.



## DataDotDNA®

Every Subaru is fitted with advanced engine immobilisers and the DataDotDNA<sup>®2</sup> Theft Deterrent System. Microscopic dots are laser-etched with each vehicle's unique Vehicle Identification Number – making it a less attractive target for thieves.

## Three Year Rebate on Theft Insurance Excess

DataDot Technology (Australia) Pty Ltd will pay your theft insurance excess<sup>3</sup> (up to a maximum of \$800 including GST) should your new Subaru be stolen in the first three years of purchase and not recovered within 45 days despite the presence of DataDotDNA<sup>®2</sup> and warning labels.

## 1-Month Health Check and Chat

The 1-Month Health Check and Chat is a free consultation within the first month after delivery of your new Subaru. It allows our factory-trained technicians to provide quick vehicle checks, and one of our Service Advisors will answer any of your questions to help ensure an ongoing, worry-free experience.

## Subaru's Map Updates

If your new Subaru is fitted with a factory line fit navigation unit your unit will be covered by Subaru's Map Update Program<sup>4</sup> – guaranteeing you'll have access to the latest maps for the first 3 years of ownership.

## My Subaru – online owner's destination

The My Subaru owner's portal is an online destination for owners which provides access to exclusive benefits, tailored content, your vehicle's ownership history and much more.

1. Every eligible Model Year 2018 onward Subaru Impreza comes with Subaru's 5 Year/62,500 Km Capped Price Servicing Program. Available at participating Subaru Retailers only and does not apply to rental and some other classes of vehicles. For full Capped Price Servicing Terms and Conditions visit [www.subaru.com.au/service/pricing/capped-price-servicing](http://www.subaru.com.au/service/pricing/capped-price-servicing). 2. DataDotDNA<sup>®</sup> is a theft deterrent not a theft prevention mechanism. 3. Vehicles must be registered, comprehensively insured and less than 3 years old. DTA must receive a claim within 45 days of the theft. Terms and conditions apply. 4. Subaru's Map Update Program is available on MY19 Subaru Impreza models purchased from November 01, 2018 onwards with the factory line fit Gen3.1 navigation unit. Subaru's Map Update Program is not available on accessory fit or dealer sourced navigation units. For full terms and conditions of the Subaru Map Update Program visit [www.subaru.com.au/owner-experience/benefits/subaru-map-update-program](http://www.subaru.com.au/owner-experience/benefits/subaru-map-update-program).

# live life without limits

Login to My Subaru, the online destination for Subaru owners that will help you get more out of your vehicle, and more out of your life. Visit [my.subaru.com.au](https://my.subaru.com.au)

## Subaru Roadside Assistance

Enjoy 12 months of Australia-wide, standard Roadside Assistance when you purchase your new Subaru. In the unfortunate situation where you need that extra helping hand, our Roadside Assistance will help<sup>1</sup> with arranging a tow, battery service, flat tyre service, fuel delivery and lockout service.

## Subaru Certified Collision Repairer Network

With a dedicated Subaru Certified Collision Repairer<sup>2</sup> helpline available on 1800 737 179, help is available when you need it most. Available 24-hours a day, 7 days a week, help is only a phone call away. Subaru Certified Collision Repairers guarantee that trained specialists will repair your Subaru to strict factory specifications using Genuine Subaru Parts.

## Genuine Accessories

Genuine Subaru Accessories are designed to enhance your vehicle, help you get more stuff done and have more fun! Our genuine accessories are factory approved by Subaru and are protected by the Genuine Subaru Accessories Warranty. For our full range of Subaru Impreza accessories visit [subaru.com.au/impreza/accessories](https://subaru.com.au/impreza/accessories). For warranty information visit [subaru.com.au/warranty](https://subaru.com.au/warranty) and click on "Genuine Subaru Accessories Warranty".

## Subaru Finance

Subaru Finance<sup>3</sup> provides a range of competitive financial solutions to approved customers. Our finance specialists will help you find a finance package to meet your needs conveniently.

## Subaru Insurance

It's important to enjoy the freedom of owning a Subaru, but it's also important to protect it. A range of Subaru Insurance<sup>4</sup> options provides a variety of choices, including: Subaru Comprehensive Motor Vehicle Insurance and Subaru Loan Protection Insurance.

## Subaru Certified Used Cars

Every Subaru Certified Used Car has passed a 120-point quality inspection and comes with a one year unlimited kilometre Subaru Assured Warranty<sup>5</sup> – to complement the balance of a new vehicle warranty or the statutory warranty that remains – from participating Subaru Certified Used Car Retailers.

1. 12 month Club Membership and Roadside Assistance Offer is standard upon activation with the relevant Motoring Club in each state. To receive this benefit the customer must opt into the 12 month Club Membership and Roadside Assistance Offer at time of vehicle delivery. Eligible customers are those retail and novated lease customers who purchase a new Subaru and have less than 5 vehicles under the Club Membership offer. Customers must provide a valid phone number and residential address, as well as date of birth. Fleet, Government and Rental companies are excluded. Terms and conditions apply. For a full list of benefits, visit [www.subaru.com.au/owner-experience/benefits/program/roadside](https://www.subaru.com.au/owner-experience/benefits/program/roadside). 2. Subaru Certified Collision Repairer network not available in all areas. Call 1800 737 179 or visit [www.subaru.com.au/retailers](https://www.subaru.com.au/retailers) to find your closest Subaru Certified Collision Repairer. 3. Finance provided by Macquarie Leasing Pty Limited ABN 38 002 674 982 Australian Credit Licence Number 394925 trading as Subaru Finance. All applications for credit are subject to Macquarie's normal credit approval criteria. Terms and conditions, fees and charges apply. 4. Subaru Insurance products are issued by Allianz Australia Insurance Limited AFS Licence No. 234 708 ABN 15 000 122 850 (Allianz). In arranging this insurance Subaru (Aust) Pty Limited ABN 95 000 312 792 (Subaru) and the authorised dealers act as agents of Allianz and not as your agent. Neither Subaru nor any of its related companies or appointed authorised retailers have any liability in respect of these policies. 5. The Subaru Assured Warranty product is issued by the selling Subaru Retailer. Subaru Australia has no liability in respect of this warranty.

## Subaru Impreza Awards

- 2016 - Australasian New Car Assessment Program 5 star ANCAP safety rating for the entire Impreza range
- 2011 - Australasian New Car Assessment Program 5 star ANCAP safety rating for the entire Impreza range
- 2007 - Australasian New Car Assessment Program 5 star ANCAP safety rating for the entire Impreza range
- 2003 - Australia's Best Cars, Best Mid-Size Car 2003 under \$28,000, Subaru Impreza GX
- 2000 - Wheels Car of the Year, Subaru Impreza
  - QLD Car of the Year Awards, Outstanding Compact Car, Subaru Impreza

Subaru Australia reserves the right to vary vehicle specifications and standard features in Australia from those detailed in this brochure. Vehicles shown in this brochure may be fitted with accessories available at additional cost. No part of the brochure can be reproduced without written permission from Subaru Australia. Printed in Australia.

[subaru.com.au](http://subaru.com.au)

© Copyright 2019 – Subaru (Aust) Pty Limited. All rights reserved.  
Subaru (Aust) Pty Limited ABN 95 000 312 792 (Subaru Australia) PO Box 8311, Norwest NSW 2153 Toll Free: 1800 226 643

