

SUBARU
FORESTER
ALL-WHEEL DRIVE

**every moment
is a chance to do**



2020



SUBARU



Find out more at www.subaru.com.au/forester



Forester 2.5i-S AWD

every moment is a chance to do

Every moment you and your family spend in the Subaru Forester is designed to be awesome.

Plenty of space, super comfortable seats, dual zone climate control, clever storage pockets and an intuitive touchscreen infotainment system make every drive more enjoyable. Your music, maps and contacts are right where you need them, thanks to Apple CarPlay® and Android Auto™ connectivity¹, so you can get stuff done on the go.

The new generation Forester is built on the Subaru Global Platform which delivers a low centre of gravity, supreme stability, responsive steering control and a quieter cabin. This makes the ultimate family SUV safer to its core.

There's nothing more important than protecting your family, which is why every Forester also comes with EyeSight® Driver Assist technology, like a second pair of eyes looking out for you.

Make the most of every moment in the next generation Subaru Forester. Book a test drive today.

1. Compatible Apple® or Android™ device required.



Forester 2.5i AWD

packed with features

The Subaru Forester helps you seize moments great and small – epic adventures, spontaneous trips and everyday life. Big windows and smart pillar design gives you great visibility.

The Forester 2.5i AWD is loaded with amazing features like EyeSight® Driver Assist technology including Adaptive Cruise Control, a 6.5" touchscreen and handy rear USB ports that can charge your passengers' devices. An array of lighting features makes the Forester 2.5i AWD safer and more stylish, including Steering Responsive LED Headlights, LED tail lights and Daytime Running Lights.

Forester 2.5i AWD features

Performance

- + Symmetrical All-Wheel Drive (AWD)
- + 2.5-litre horizontally-opposed Boxer 4-cylinder, direct injection petrol engine
- + Lineartronic® CVT with manual mode
- + Maximum power output: 136kW@5800rpm
- + Maximum torque: 239Nm@4400rpm
- + X-Mode

Interior

- + 60/40 split folding rear seats
- + Air-conditioning – dual zone climate control with rear vents
- + Cloth seat trim – choice of black or platinum and black
- + Electronic parking brake
- + One touch lane change indicator
- + Reclining rear seat
- + Smart key and push-start ignition
- + USB charge port – rear passengers (x2)

+ Exterior

- + 17" alloy wheels
- + Daytime Running Lights – LED
- + Door mirrors with indicators – heated and power-folding
- + Front fog lights
- + LED tail lights
- + Push open fuel lid
- + Rain-sensing front windscreen wipers
- + Rear mud guards
- + Rear view reverse camera – with washer
- + Roof rails
- + Self-levelling LED headlights with auto off (dusk-sensing)
- + Steering Responsive Headlights (SRH)
- + Wheel arch mouldings

Entertainment/Technology

- + Bluetooth®¹ wireless technology
- + EyeSight® Driver Assist system featuring:
 - + Adaptive Cruise Control

- + Brake Light Recognition
- + Emergency Lane Keep Assist
- + Lane Departure Warning
- + Lane Keep Assist
- + Lane Sway Warning
- + Lead Vehicle Start Alert
- + Pre-Collision Brake Assist
- + Pre-Collision Braking System
- + Pre-Collision Throttle Management
- + Speed Limiter
- + Integrated infotainment system featuring:
 - + 6.5" LCD touchscreen
 - + Apple CarPlay® and Android Auto™ connectivity²
 - + Digital radio³ (DAB+)
 - + Siri®⁴ compatibility
- + Multi-Function Display unit (MFD) with 6.3" LCD screen
- + Multi-Information Display unit (MID)
- + Subaru's Vision Assist

1. Bluetooth® is a registered trademark of Bluetooth SIG Inc. System functionality is subject to the Bluetooth® wireless technology specification of individual device. 2. Compatible Apple® or Android™ device required. 3. Digital radio station coverage dependent on vehicle location. 4. Requires compatible Siri® enabled Apple® device to be paired with the infotainment system.

scans the road and your face

The Forester 2.5i-L AWD features Subaru's Driver Monitoring System - Driver Focus¹, which uses facial scanning technology to scan your face for signs of drowsiness and distraction. Every moment on the road is safer and easier with Adaptive Driving Beam, which automatically switch your headlights to low beam for oncoming traffic, and Reverse Automatic Braking which can detect obstacles in your way and apply the brakes to help you avoid backing into them.

Forester 2.5i-L AWD features

Performance

- + Symmetrical All-Wheel Drive (AWD)
- + 2.5-litre horizontally-opposed Boxer 4-cylinder, direct injection petrol engine
- + Lineartronic[®] CVT with manual mode
- + Maximum power output: 136kW@5800rpm
- + Maximum torque: 239Nm@4400rpm
- + X-Mode

Interior

- + 60/40 split folding rear seats
- + Air-conditioning – dual zone climate control with rear vents
- + Cloth seat trim – choice of black or platinum and black
- + Electronic parking brake
- + Heated seats – driver and front passenger
- + One touch lane change indicator
- + Reclining rear seat
- + Smart key and push-start ignition
- + USB charge port – rear passengers (x2)

+ Exterior

- + 17" alloy wheels
- + Daytime Running Lights – LED
- + Door mirrors with indicators – heated and power-folding
- + Front fog lights
- + LED tail lights
- + Push open fuel lid
- + Rain-sensing front windscreen wipers
- + Rear mud guards
- + Rear view reverse camera – with washer
- + Roof rails
- + Self-levelling LED headlights with auto off (dusk-sensing)
- + Steering Responsive Headlights (SRH)
- + Wheel arch mouldings

Entertainment/Technology

- + *Bluetooth*^{®2} wireless technology

- + Driver Monitoring System - Driver Focus¹ featuring:
 - + Climate control setting (last used)
 - + Distraction warning
 - + Drowsiness warning
 - + Facial recognition
 - + MFD display (last used)
 - + MID display (last used)
- + EyeSight[®] Driver Assist system
- + Integrated infotainment system featuring:
 - + 6.5" LCD touchscreen
 - + Apple CarPlay[®] and Android Auto[™] connectivity³
 - + Digital radio⁴ (DAB+)
 - + Siri^{®5} compatibility
- + Multi-Function Display unit (MFD) with 6.3" LCD screen
- + Multi-Information Display unit (MID)
- + Subaru's Vision Assist

Scans the road and your face.
Explore the range at www.subaru.com.au/forester

1. Driver Monitoring System performance and capability dependent on environmental and technical conditions. Refer to Owner's Manual for full details. 2. *Bluetooth*[®] is a registered trademark of Bluetooth SIG Inc. System functionality is subject to the *Bluetooth*[®] wireless technology specification of individual device. 3. Compatible Apple[®] or Android[™] device required. 4. Digital radio station coverage dependent on vehicle location. 5. Requires compatible Siri[®] enabled Apple[®] device to be paired with the infotainment system.



FORESTER

Forester 2.5i-L AWD



Forester 2.5i Premium AWD

brimming with tech

The Subaru Forester 2.5i Premium AWD is sporty, comfy and brimming with tech to make every moment more fun. As well as sports pedals and 18" alloy wheels, Subaru Intelligent Drive technology lets you switch from Intelligent (I) mode to Sport (S) mode.

You'll get away quicker with a fast-powered tailgate, 8-way powered front seats, one touch folding rear seats, auto power-folding mirrors and an upgraded 8" LCD touchscreen with inbuilt satellite navigation. The Driver Monitoring System¹ can recognise your face and instantly adjust the seat, mirrors and climate to your personal settings so you can take off at a moment's notice.

Forester 2.5i Premium AWD features

Performance

- + Symmetrical All-Wheel Drive (AWD)
- + 2.5-litre horizontally-opposed Boxer 4-cylinder, direct injection petrol engine
- + Lineartronic[®] CVT with manual mode
- + Maximum power output: 136kW@5800rpm
- + Maximum torque: 239Nm@4400rpm
- + Subaru Intelligent Drive (SI-Drive) – 2 mode
- + X-Mode

Interior

- + 60/40 split folding rear seats
- + 8-way power seats – driver and front passenger (driver with dual memory)
- + Air-conditioning – dual zone climate control with rear vents
- + Electronic parking brake
- + Heated seats – driver and front passenger
- + Premium cloth seat trim – choice of black or platinum and black

- + Smart key and push-start ignition
- + USB charge port – rear passengers (x2)

Exterior

- + 18" alloy wheels
- + Auto-dipping mirror – passenger side
- + Daytime Running Lights – LED
- + Door mirrors with indicators – heated and auto power-folding
- + Front fog lights
- + LED tail lights
- + Powered tailgate
- + Push open fuel lid
- + Rain-sensing front windscreen wipers
- + Rear mud guards
- + Rear view reverse camera – with washer
- + Self-levelling LED headlights with auto off (dusk-sensing)
- + Steering Responsive Headlights (SRH)
- + Wheel arch mouldings

Entertainment/Technology

- + Bluetooth^{®2} wireless technology
- + Driver Monitoring System¹ – Driver Focus featuring:
 - + Auto door mirror adjustment
 - + Auto driver's seat adjustment
 - + Climate control setting (last used)
 - + Distraction warning
 - + Drowsiness warning
 - + Facial recognition
 - + MFD display (last used)
 - + MID display (last used)
- + EyeSight[®] Driver Assist system
- + Integrated infotainment system featuring:
 - + 8" LCD touchscreen
 - + Apple CarPlay[®] and Android Auto[™] connectivity³
 - + Digital radio⁴ (DAB+)
 - + Satellite navigation
 - + Siri^{®5} compatibility
- + Multi-Function Display unit (MFD) with 6.3" LCD screen
- + Multi-Information Display unit (MID)
- + Subaru's Vision Assist

1. Driver Monitoring System performance and capability dependent on environmental and technical conditions. Refer to Owner's Manual for full details. 2. Bluetooth[®] is a registered trademark of Bluetooth SIG Inc. System functionality is subject to the Bluetooth[®] wireless technology specification of individual device. 3. Compatible Apple[®] or Android[™] device required. 4. Digital radio station coverage dependent on vehicle location. 5. Requires compatible Siri[®] enabled Apple[®] device to be paired with the infotainment system.

loaded with luxury

Step it up with the Forester 2.5i-S AWD. With leather accented seats and a state of the art Harman Kardon®¹ stereo to crank out more of the music you love. Plus, you'll make the most of every beautiful day with a super large electric sunroof.

Forester 2.5i-S AWD features

Performance

- + Symmetrical All-Wheel Drive (AWD)
- + 2.5-litre horizontally-opposed Boxer 4-cylinder, direct injection petrol engine
- + Lineartronic® CVT with manual mode
- + Maximum power output: 136kW@5800rpm
- + Maximum torque: 239Nm@4400rpm
- + Subaru Intelligent Drive (SI-Drive) – 2 mode
- + X-Mode – 2 mode

Interior

- + 60/40 split folding rear seats
- + 8-way power seats – driver and front passenger (driver with dual memory)
- + Air-conditioning – dual zone climate control with rear vents
- + Electronic parking brake
- + Heated seats – driver and front passenger
- + Leather accented seats – choice of black or platinum and black
- + One touch electric folding rear seats
- + One touch lane change indicator
- + Reclining rear seat
- + Smart key and push-start ignition
- + Sports pedals
- + USB charge port – rear passengers (x2)

Exterior

- + 18" alloy wheels
- + Auto-dipping mirror – passenger side
- + Daytime Running Lights – LED
- + Door mirrors with indicators – heated and auto power-folding (silver)
- + Electric sunroof
- + Front fog lights – LED
- + LED tail lights
- + Powered tailgate
- + Push open fuel lid
- + Rain-sensing front windscreen wipers
- + Rear mud guards
- + Rear view reverse camera – with washer
- + Self-levelling LED headlights with auto off (dusk-sensing)
- + Steering Responsive Headlights (SRH)

Entertainment/Technology

- + 8 Harman Kardon®¹ speakers, subwoofer and amplifier
- + Bluetooth®² wireless technology

- + Driver Monitoring System³ – Driver Focus featuring:
 - + Auto door mirror adjustment
 - + Auto driver's seat adjustment
 - + Climate control setting (last used)
 - + Distraction warning
 - + Drowsiness warning
 - + Facial recognition
 - + MFD display (last used)
 - + MID display (last used)
- + EyeSight® Driver Assist system
- + Integrated infotainment system featuring:
 - + 8" LCD touchscreen
 - + Apple CarPlay® and Android Auto™ connectivity⁴
 - + Digital radio⁵ (DAB+)
 - + Satellite navigation
 - + Siri®⁶ compatibility
- + Multi-Function Display unit (MFD) with 6.3" LCD screen
- + Multi-Information Display unit (MID)
- + Subaru's Vision Assist

Loaded with luxury.

Explore the range at www.subaru.com.au/forester

1. Harman Kardon® is a registered trademark of HARMAN International Industries, Incorporated. 2. Bluetooth® is a registered trademark of Bluetooth SIG Inc. System functionality is subject to the Bluetooth® wireless technology specification of individual device. 3. Driver Monitoring System performance and capability dependent on environmental and technical conditions. Refer to Owner's Manual for full details. 4. Compatible Apple® or Android™ device required. 5. Digital radio station coverage dependent on vehicle location. 6. Requires compatible Siri® enabled Apple® device to be paired with the infotainment system.



Forester 2.5i-S AWD



Forester Hybrid L AWD

fully charged and ready to roll

The Subaru Forester Hybrid L AWD is Subaru future tech in action. Built around the all-new e-Boxer, Subaru's new generation power unit, the Forester Hybrid L AWD delivers better low speed acceleration and torque, for a highly responsive drive with effortless efficiency and lower fuel consumption. Working in synergy with Subaru Symmetrical All-Wheel Drive, the e-Boxer captures excess engine power and braking energy to recharge the electric battery – so you never need to plug it in.

Forester Hybrid L AWD features

Performance

- + Symmetrical All-Wheel Drive (AWD)
- + 2.0-litre horizontally-opposed e-Boxer 4-cylinder, direct injection petrol engine
- + Lineartronic® CVT with manual mode
- + Maximum petrol engine power output: 110kW@6000rpm
- + Maximum petrol engine torque: 196Nm@4000rpm
- + Maximum electric motor power output: 12.3kW
- + Maximum electric motor torque: 66Nm
- + X-Mode

Interior

- + Air-conditioning – dual zone climate control with rear vents
- + Premium cloth seat trim – black
- + Electronic parking brake
- + Heated seats – driver and front passenger
- + One touch lane change indicator

- + Smart key and push-start ignition
- + USB charge port – rear passengers (x2)

Exterior

- + 17" alloy wheels
- + Black coloured rear garnish
- + Daytime Running Lights – LED
- + Door mirrors with indicators – heated and power-folding (silver)
- + Front fog lights – LED
- + LED tail lights
- + Puncture repair kit
- + Rain-sensing front windscreen wipers
- + Rear view reverse camera – with washer
- + Roof rails
- + Self-levelling LED headlights with auto off (dusk-sensing)
- + Steering Responsive Headlights (SRH)

Entertainment/Technology

- + Bluetooth®¹ wireless technology
- + Driver Monitoring System² – Driver Focus featuring:
 - + Climate control setting (last used)
 - + Distraction warning
 - + Drowsiness warning
 - + Facial recognition
 - + MFD display (last used)
 - + MID display (last used)
- + EyeSight® Driver Assist system
- + Integrated infotainment system featuring:
 - + 6.5" LCD touchscreen
 - + Apple CarPlay® and Android Auto™ connectivity³
 - + Digital radio⁴ (DAB+)
 - + Siri®⁵ compatibility
- + Multi-Function Display unit (MFD) with 6.3" LCD screen
- + Multi-Information Display unit (MID)
- + Pedestrian alert system
- + Subaru's Vision Assist

1. Bluetooth® is a registered trademark of Bluetooth SIG Inc. System functionality is subject to the Bluetooth® wireless technology specification of individual device. 2. Driver Monitoring System performance and capability dependent on environmental and technical conditions. Refer to Owner's Manual for full details. 3. Compatible Apple® or Android™ device required. 4. Digital radio station coverage dependent on vehicle location. 5. Requires compatible Siri® enabled Apple® device to be paired with the infotainment system.

effortless efficiency

Step up to the Subaru Forester Hybrid S AWD with an 8" LCD touchscreen, satellite navigation, electric sunroof, powered tailgate and stylish leather accented seat trim.

Forester Hybrid S AWD features

Performance

- + Symmetrical All-Wheel Drive (AWD)
- + 2.0-litre horizontally-opposed e-Boxer 4-cylinder, direct injection petrol engine
- + Lineartronic® CVT with manual mode
- + Maximum petrol engine power output: 110kW@6000rpm
- + Maximum petrol engine torque: 196Nm@4000rpm
- + Maximum electric motor power output: 12.3kW
- + Maximum electric motor torque: 66Nm
- + Subaru Intelligent Drive (SI-Drive) – 2 mode
- + X-Mode – 2 mode

Interior

- + 8-way power seats – driver and front passenger (driver with dual memory)
- + Air-conditioning – dual zone climate control with rear vents
- + Electronic parking brake
- + Heated seats – driver and front passenger
- + Leather accented seats – black

- + One touch electric folding rear seats
- + One touch lane change indicator
- + Smart key and push-start ignition
- + Sports pedals
- + USB charge port – rear passengers (x2)

Exterior

- + 18" alloy wheels
- + Auto-dipping mirror – passenger side
- + Black coloured rear garnish
- + Daytime Running Lights – LED
- + Door mirrors with indicators – heated and power-folding (silver)
- + Electric sunroof
- + Front fog lights – LED
- + LED tail lights
- + Powered tailgate
- + Puncture repair kit
- + Rain-sensing front windscreen wipers
- + Rear view reverse camera – with washer
- + Roof rails
- + Self-levelling LED headlights with auto off (dusk-sensing)
- + Steering Responsive Headlights (SRH)

Entertainment/Technology

- + 8 Harman Kardon®¹ speakers, subwoofer and amplifier
- + Bluetooth®² wireless technology
- + Driver Monitoring System³ – Driver Focus featuring:
 - + Auto door mirror adjustment
 - + Auto driver's seat adjustment
 - + Climate control setting (last used)
 - + Distraction warning
 - + Drowsiness warning
 - + Facial recognition
 - + MFD display (last used)
 - + MID display (last used)
- + EyeSight® Driver Assist system
- + Integrated infotainment system featuring:
 - + 8" LCD touchscreen
 - + Apple CarPlay® and Android Auto™ connectivity⁴
 - + Digital radio⁵ (DAB+)
 - + Satellite navigation
 - + Siri®⁶ compatibility
- + Pedestrian alert system
- + Subaru's Vision Assist

1. Harman Kardon® is a registered trademark of HARMAN International Industries, Incorporated. 2. Bluetooth® is a registered trademark of Bluetooth SIG Inc. System functionality is subject to the Bluetooth® wireless technology specification of individual device. 3. Driver Monitoring System performance and capability dependent on environmental and technical conditions. Refer to Owner's Manual for full details. 4. Compatible Apple® or Android™ device required. 5. Digital radio station coverage dependent on vehicle location. 6. Requires compatible Siri® enabled Apple® device to be paired with the infotainment system.



Forester Hybrid S AWD

the future of driving is here

Loaded with state-of-the-art safety and entertainment tech, the Subaru Forester is made to help you and your family make the most of every moment. And now Australian families have another reason to love Subaru Forester even more, with the debut of our new generation Subaru e-Boxer hybrid technology.

Self-charging on the go

e-Boxer technology combines an electric motor and high voltage battery with a petrol Boxer engine for better performance and fuel efficiency. Plus, self-charging technology captures braking energy to recharge the battery.

A perfect match

Subaru e-Boxer hybrid uses power from a compact battery and electric motor to assist the petrol engine – changing between Electric only, Motor Assist and Engine only driving modes to match the conditions.

3-way power

In certain conditions, such as when gently pulling away or driving slowly, the electric motor exclusively powers the car. However, when cruising, the petrol engine alone is the most suitable power source. While under other conditions, e-Boxer's Motor Assist engages both power sources for a superior drive.

Framed to deliver

Delivering a linear, highly-responsive drive with excellent handling and stability, the Subaru Forester Hybrid range incorporates structural changes designed to enhance overall torsional and rear suspension rigidity.

Loaded for fun

With the electric motor's battery and other electrical components positioned under the cargo floor, the Subaru Forester Hybrid range boasts generous cargo space with the same convenient height for loading all your gear and then some.

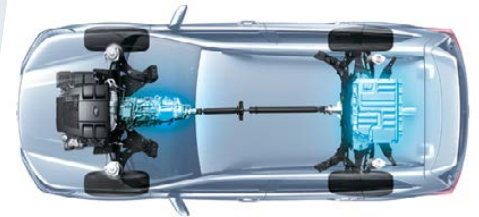



SUBARU
HYBRID
e-BOXER

The future of driving is here.
Explore the range at www.subaru.com.au/forester

why Forester?

Symmetrical force of power

Our All-Wheel Drive philosophy

Greater balance and control. That's the confidence you get from our unique Symmetrical All-Wheel Drive (AWD) system, which delivers the drive distribution to all four wheels, all the time. Every Subaru Forester has an innate sense of balance from the ground up, thanks to a near perfect symmetrical layout.

Boxing clever

Our famous Subaru Boxer engine

While most engines stand vertically, ours lay flat. The famous Subaru Boxer engine helps to deliver better handling. Sitting horizontally in the engine bay, it moves like a boxer's fists with a punch and counterpunch action. Lightweight, low and flat, it makes for perfect balance and a much lower centre of gravity. It creates less noise and vibration too. All of this means better on-road handling for you. More stability. More performance. More fun. And a more confident drive.

Finest safety

5 star ANCAP¹ safety across the Forester range

With Forester comes some serious safety innovation. We want every Subaru Forester to be amongst the safest cars on the road. Engineered full of cutting-edge technologies and the most intelligent design features. The Subaru Forester carries the maximum 5 star ANCAP safety rating.

The backbone of the future

Subaru Global Platform

The Forester is built on the new Subaru Global Platform (SGP). Revolutionary Subaru engineering underpins the superior modular platform for enhanced performance, safety and drivability. Innovative to the core, the game changing frame delivers reduced vibration, less roll when cornering, a smoother ride and improved overall road dynamics. The result? A drive that's damn near perfect and super smooth - with greater straight line stability, improved rigidity, responsive steering control and a quieter cabin.

Eyes in the back of your head

Rear view reverse camera

Manoeuvring back into a tight side street? Family driveway littered with toys? Reverse with confidence, thanks to our rear view reverse camera technology. The rear view reverse camera is like having eyes in the back of your head. This greatly improves your visibility and reduces the risk of bumps and scrapes. A rear view reverse camera is standard across the Subaru Forester range.

Efficiency without compromise

Auto Stop Start

We're constantly thinking of ways to help the environment and become more fuel-efficient. That's why we developed Auto Stop Start technology. It saves fuel by cutting the engine when you don't need it, like when you're idling or stopped in heavy traffic. The moment you're ready to move again, the engine restarts in a fraction of a second. Our Auto Stop Start technology is standard across the Subaru Forester range.

1. The Australasian New Car Assessment Program (ANCAP) gives consumers consistent information on the level of occupant protection provided by vehicles in serious front and side crashes.

The eyes have it

Driver Monitoring System - Driver Focus¹

Using the facial recognition capabilities of the Driver Monitoring System – Driver Focus, the Forester may identify the driver as they take their seat and automatically adjust cabin settings to that driver's pre-programmed preferences. The individual preferences of up to five drivers can be stored, allowing the Multi-Function Display, instrument settings and climate control to be restored to the driver's last setting. Also, the driver's seat and door mirror positions are moved to the driver's personal settings on the 2.5i Premium AWD, 2.5i-S AWD and Hybrid S AWD variants.

Yet another world first

Lineartronic[®] CVT

Pushing innovation beyond the bounds, we introduced an automatic transmission called Lineartronic[®] Continuously Variable Transmission (CVT) and it's the reason our automatic models drive so smooth. It's the

world's first longitudinally mounted system for AWD vehicles. Unlike a conventional automatic transmission – which uses fixed gear ratios – our Lineartronic[®] CVT provides infinite variability between the highest and lowest available ratios. So you now experience a smoothness that also optimises the efficiency of the vehicle. For even more excitement, switch to manual mode for greater control to suit your driving style. Lineartronic[®] CVT is standard on all Forester variants.

Intelligently driven

Subaru Intelligent Drive

Heading to the shops? Taking on the Great Ocean Road? Each situation deserves a distinctive driving mode, so we crafted Subaru Intelligent Drive (SI-Drive) technology to do just that. Intelligent (I) mode – perfect for everyday driving and Sport (S) mode – for enhanced acceleration and all-round sport performance. SI-Drive is standard on Forester 2.5i Premium AWD, 2.5i-S AWD and Hybrid S AWD.

Get smart

X-Mode

When the going gets tough, engage Subaru's intelligent X-Mode, standard across the Subaru Forester range. Featuring Hill Descent Control which optimises traction in low speed and slippery conditions, X-Mode delivers uncompromising performance in challenging terrain.

We're looking out for you

EyeSight[®] Driver Assist

We were the first car company to exclusively use stereo camera technology to detect objects in our vehicle's path. A sign of our future-thinking and our commitment to quality, technology and safety, EyeSight[®] Driver Assist is like your second pair of eyes, spotting potentially dangerous situations. If EyeSight[®] detects anything that might be of danger, it warns you audibly, urging you to take action and brake. EyeSight[®] is standard across the Subaru Forester range.

1. Driver Monitoring System - Driver Focus performance and capability dependent on environmental and technical conditions. Refer to Owner's Manual for full details. Excludes Subaru Forester 2.5i AWD variant.

get more done

Clever design, beautiful finishes and cutting-edge tech make the Forester more enjoyable and productive. A large intuitive touchscreen connects to your phone using Apple CarPlay® and Android Auto™ connectivity¹, plus extra device charging ports in the back and plenty of legroom. A rear view reverse camera will also make it easier to get away safely.



USB charge ports – rear (x2)
All Forester variants



X-Mode (2 mode)
Forester 2.5i-S AWD



Steering wheel controls
Forester 2.5i Premium AWD,
2.5i-S AWD and Hybrid S
AWD



Harman Kardon®² speakers
Forester 2.5i-S AWD and
Hybrid S AWD



1. Compatible Apple® or Android™ device required.
2. Harman Kardon® is a registered trademark of HARMAN International Industries, Incorporated.

be inspired

Interior

On the inside, choose from black or platinum/black cloth in the Forester 2.5i AWD and 2.5i-L AWD. Forester 2.5i Premium AWD and Forester Hybrid L AWD feature premium cloth. And for the 2.5i-S AWD and range-topping Forester Hybrid S AWD, sumptuous leather accented seats are available.



Cloth
Black



Cloth
Platinum/Black

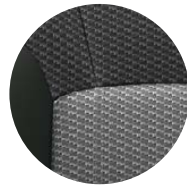

Premium Cloth
Black



Premium Cloth¹
Platinum/Black



Leather
Black



Leather²
Platinum/Black

Exterior

The colour you choose for your Subaru makes a bold statement about who you are. So we've made sure you've got lots of ways to express yourself – with a wide range of colours to make your Subaru more...you.



Crystal White
Pearl

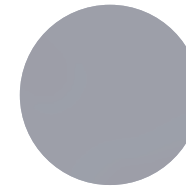

Ice Silver
Metallic

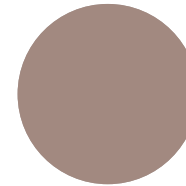

Sepia Bronze
Metallic

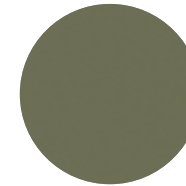

Jasper Green
Metallic

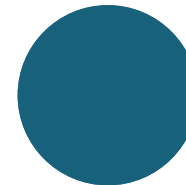

Horizon Blue
Pearl

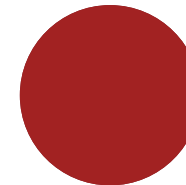

Crimson Red
Pearl

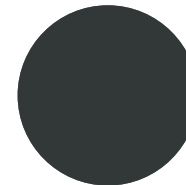

Magnetite Grey
Metallic

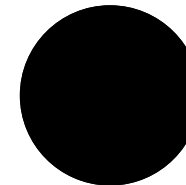

Crystal Black
Silica

1. Platinum/black premium cloth not available on Forester Hybrid L AWD.
2. Platinum/black leather not available on Forester Hybrid S AWD.

Note: Paint colours are representative only and subject to variation due to the printing process.

Subaru Forester specifications¹

MODEL	2.5i AWD	2.5i-L AWD	2.5i Premium AWD	2.5i-S AWD	Hybrid L AWD	Hybrid S AWD
	SUV	SUV	SUV	SUV	SUV	SUV
Transmission						
Lineartronic® CVT	•	•	•	•	•	•
Engine						
Engine type	Direct injected, horizontally-opposed Boxer 4-cylinder, petrol engine				Direct injected, horizontally-opposed e-Boxer 4 cylinder, petrol engine	
Valve mechanism	DOHC with Dual AVCS					
Bore x stroke	mm	94.0 x 90.0			84.0 x 90.0	
Capacity	cc	2498			1995	
Compression ratio		12.0:1			12.5:1	
Fuel tank capacity	litres	63			48	
Fuel system		Direct injection				
Fuel requirement (min)	RON	91				
Electric Motor						
Electric motor		n/a			Permanent magnet AC synchronous motor	
Battery type		n/a			Lithium-ion	
Performance²						
Maximum power output (DIN)	kW/rpm	136kW@5800rpm			110kW @ 6000rpm	
Maximum torque (DIN)	Nm/rpm	239Nm@4400rpm			196Nm @ 4000rpm	
Electric motor maximum power		n/a			12.3kW	
Electric motor maximum torque		n/a			66Nm	
Electronic Throttle Control system (ETC)		Drive-by-wire				
Fuel consumption (ADR 81/02) For comparison purposes only. Real world results may vary ³ :						
	combined	l/100km	7.4			6.7
	urban	l/100km	9.3			7.5
	extra urban	l/100km	6.3			6.2

1. Subaru Australia reserves the right to change mechanical specification and equipment levels without notice. 2. All performance data measured using 95RON test fuel as required by Australian Design Rule 81/02. Vehicles tested in accordance with ADR 81/02. 3. Fuel consumption figures quoted are measured in accordance with Australian Design Rule 81/02 and are for comparison purposes only. Real world results may vary based on individual driving circumstances e.g. traffic conditions, driving style, vehicle modifications, fuel quality, climatic conditions etc. Quoted figures may not reflect real world fuel consumption.

Subaru Forester specifications¹

MODEL			2.5i AWD	2.5i-L AWD	2.5i Premium AWD	2.5i-S AWD	Hybrid L AWD	Hybrid S AWD
CO ₂ emissions (ADR 81/02)	combined	(g/km)	168				152	
Symmetrical All-Wheel Drive (AWD)								
Type	Auto		Active Torque Split					
Transmission								
Gear ratio	1st		3.600			3.552		
	2nd		2.323			1.892		
	3rd		1.647			1.474		
	4th		1.241			1.228		
	5th		0.979			1.024		
	6th		0.746			0.852		
	7th		0.557			0.682		
Gear ratio – reverse			3.687			3.689		
Final reduction gear ratio			3.900					
Steering								
Type			Electric power assisted rack and pinion					
Minimum turning circle	m		10.8					
Suspension								
Type	Front		MacPherson struts, lower L-arms, coil springs, stabiliser bar					
	Rear		Double wishbone type, independent suspension					
Brakes								
Type	Front		Ventilated disc brake					
	Rear		Ventilated disc brake					
Brake booster type			Tandem					
ABS			4-channel, 4-sensor ABS with Electronic Brakeforce Distribution					

1. Subaru Australia reserves the right to change mechanical specification and equipment levels without notice.

Subaru Forester specifications¹

MODEL		2.5i AWD	2.5i-L AWD	2.5i Premium AWD	2.5i-S AWD	Hybrid L AWD	Hybrid S AWD
Wheels and Tyres							
Tyre manufacturer		Bridgestone					
Tyres (width, profile, size, load index and speed rating)		225/60 R17 99V		225/55 R18 98V		225/60 R17 99V	225/55 R18 98V
Rim size		17x7J		18x7J		17x7J	18x7J
Wheels		17"		18"		17"	18"
Spare wheel		17"		18"		n/a (Puncture repair kit)	
Measurement							
Overall length	mm	4625					
Overall width	mm	1815					
Overall height	mm	1730					
Wheel base	mm	2670					
Front track	mm	1565					
Rear track	mm	1570					
Minimum ground clearance ²	mm	220					
Cargo volume – rear seat up/down	litres	498/1768				509/1779	
Seating capacity		5					
Tare mass ³	kg	1520	1522	1543	1575	1603	1642
Towing							
With trailer brakes (max)	kg	1500				1200	
Without trailer brakes (max)	kg	750					
Maximum tow ball down load	kg	150				120	

1. Subaru Australia reserves the right to change mechanical specification and equipment levels without notice. 2. Ground clearance at kerb weight. 3. Vehicle tare mass varies according to the types of optional equipment included.

Subaru Forester features¹

MODEL	2.5i AWD	2.5i-L AWD	2.5i Premium AWD	2.5i-S AWD	Hybrid L AWD	Hybrid S AWD
Safety Rating						
5 star ANCAP ² safety rating (maximum 5)	•	•	•	•	•	•
Collision Avoidance						
Symmetrical All-Wheel Drive (AWD)	•	•	•	•	•	•
4-wheel disc brakes	•	•	•	•	•	•
Auto Vehicle Hold (AVH)	•	•	•	•	•	•
Driver Monitoring System – Driver Focus ³ featuring:		•	•	•	•	•
Auto door mirror adjustment			•	•		•
Auto driver's seat adjustment			•	•		•
Climate control setting (last used)		•	•	•	•	•
Distraction warning		•	•	•	•	•
Drowsiness warning		•	•	•	•	•
Facial recognition		•	•	•	•	•
MFD display (last used)		•	•	•	•	•
MID display (last used)		•	•	•	•	•
Electronic parking brake	•	•	•	•	•	•
Pedestrian alert system					•	•
Rear view reverse camera	•	•	•	•	•	•
Vehicle Dynamics Control system (VDC) featuring:	•	•	•	•	•	•
Active Torque Vectoring System	•	•	•	•	•	•
Anti-lock Braking System (ABS)	•	•	•	•	•	•
Brake Assist	•	•	•	•	•	•
Electronic Brakeforce Distribution (EBD)	•	•	•	•	•	•
Electronic Stability Control (ESC)	•	•	•	•	•	•
Traction Control System (TCS)	•	•	•	•	•	•

1. Subaru Australia reserves the right to change mechanical specification and equipment levels without notice. 2. The Australasian New Car Assessment Program (ANCAP) gives consumers consistent information on the level of occupant protection provided by vehicles in serious front and side crashes. 3. Driver Monitoring System - Driver Focus performance and capability dependent on environmental and technical conditions. Refer to Owner's Manual for full details.

Subaru Forester features¹

MODEL	2.5i AWD	2.5i-L AWD	2.5i Premium AWD	2.5i-S AWD	Hybrid L AWD	Hybrid S AWD
Subaru's Vision Assist featuring:	•	•	•	•	•	•
Adaptive Driving Beam (ADB)		•	•	•	•	•
Blind Spot Monitor (BSM)	•	•	•	•	•	•
EyeSight® Assist Monitor	•	•	•	•	•	•
Front View Monitor (FVM)		•	•	•	•	•
Lane Change Assist (LCA)	•	•	•	•	•	•
Rear Cross Traffic Alert (RCTA)	•	•	•	•	•	•
Reverse Automatic Braking (RAB)		•	•	•	•	•
Side View Monitor (SVM)		•	•	•	•	•
Collision Protection						
3 point A/ELR rear seat belts	•	•	•	•	•	•
Front seat belts with pretensioners and load limiters	•	•	•	•	•	•
Height adjustable rear seat headrests for 3 seating positions	•	•	•	•	•	•
Height adjustable seat belt anchors – driver and front passenger	•	•	•	•	•	•
Height and angle adjustable front seat headrests	•	•	•	•	•	•
Ring-shaped passenger safety cell	•	•	•	•	•	•
Seat belt warning lights – all seats	•	•	•	•	•	•
SRS ² airbags – dual front, dual front side, dual curtain and driver's knee	•	•	•	•	•	•
Child Safety						
Child seat anchor points (x3)	•	•	•	•	•	•
ISOFIX anchor points (x2)	•	•	•	•	•	•
Rear door child locks	•	•	•	•	•	•
Intelligent Driving Dynamics						
Auto Stop Start	•	•	•	•	•	•
Electronic Throttle Control system (ETC)	•	•	•	•	•	•
EyeSight® Driver Assist system featuring:	•	•	•	•	•	•
Adaptive Cruise Control	•	•	•	•	•	•
Brake Light Recognition	•	•	•	•	•	•
Emergency Lane Keep Assist	•	•	•	•	•	•

1. Subaru Australia reserves the right to change mechanical specification and equipment levels without notice. 2. SRS: Supplemental Restraint System. Effective when used in conjunction with seat belts.

Subaru Forester features¹

MODEL	2.5i AWD	2.5i-L AWD	2.5i Premium AWD	2.5i-S AWD	Hybrid L AWD	Hybrid S AWD
Lane Departure Warning	•	•	•	•	•	•
Lane Keep Assist	•	•	•	•	•	•
Lane Sway Warning	•	•	•	•	•	•
Lead Vehicle Start Alert	•	•	•	•	•	•
Pre-Collision Brake Assist	•	•	•	•	•	•
Pre-Collision Braking System	•	•	•	•	•	•
Pre-Collision Throttle Management	•	•	•	•	•	•
Speed Limiter	•	•	•	•	•	•
Subaru Intelligent Drive (SI-Drive) – 2 modes:			•	•		•
Intelligent (I) mode			•	•		•
Sport (S) mode			•	•		•
Tyre Pressure Monitoring System	•	•	•	•	•	•
X-Mode	•	•	•	2 mode	•	2 mode
Chassis and Mechanism						
Front and rear stabiliser	•	•	•	•	•	•
Exterior						
17" alloy wheels	•	•			•	
18" alloy wheels			•	•		•
Body coloured door handles	•	•	•	•	Chrome look	Chrome look
Body coloured rear garnish	•	•	•	•	Black	Black
Chrome look window sills			•	•	•	•
Detachable module type windscreen wipers	•	•	•	•	•	•
Door mirrors:	•	•	•	•	•	•
Auto-dipping (passenger side)			•	•		•
Body coloured	•	•	•	Silver	Silver	Silver
Heated	•	•	•	•	•	•
Indicators	•	•	•	•	•	•
Power-folding	•	•	Auto	Auto	•	Auto
Electric sunroof				•		•
Engine cover					•	•
Exterior grade badge					•	•
Front and rear wipers with front de-icer		•	•	•	•	•

1. Subaru Australia reserves the right to change mechanical specification and equipment levels without notice.

Subaru Forester features¹

MODEL	2.5i AWD	2.5i-L AWD	2.5i Premium AWD	2.5i-S AWD	Hybrid L AWD	Hybrid S AWD
Full size spare wheel	•	•	•	•		
Privacy glass – rear door, rear quarter and rear windscreen	•	•	•	•	•	•
Puncture repair kit					•	•
Rear mud guards	•	•	•	•	•	•
Rear spoiler	•	•	•	•	•	•
Rear window wiper	•	•	•	•	•	•
Reverse camera washer	•	•	•	•	•	•
Roof rails	•	•	•	Silver inserts	Silver inserts	Silver inserts
Shark fin antenna	•	•	•	•	•	•
Side cladding	•	•	•	Silver inserts	Silver inserts	Silver inserts
Tail pipe cover			•	•		•
Wheel arch mouldings	•	•	•	•	•	•
Lighting – Exterior						
Daytime Running Lights – LED	•	•	•	•	•	•
Front fog lights	•	•	•	LED	LED	LED
Headlights – dusk-sensing	•	•	•	•	•	•
Headlights – self-levelling LED with auto off	•	•	•	•	•	•
LED tail lights	•	•	•	•	•	•
Rear bumper reflectors	•	•	•	•	•	•
Rear combination lights	•	•	•	•	•	•
Rear LED stoplight	•	•	•	•	•	•
Steering Responsive Headlights (SRH)	•	•	•	•	•	•
Lighting – Interior						
Blue interior illumination	•	•	•	•	•	•
Cabin and cargo area lights	•	•	•	•	•	•
Map lights – LED (x2)	•	•	•	•	•	•
Air-conditioning						
Anti-dust filter	•	•	•	•	•	•
Dual zone climate control with rear vents	•	•	•	•	•	•
Floor heater ducts for rear passengers	•	•	•	•	•	•
Front and side demisters	•	•	•	•	•	•
Rear windscreen demister – electric	•	•	•	•	•	•

1. Subaru Australia reserves the right to change mechanical specification and equipment levels without notice.

Subaru Forester features¹

MODEL	2.5i AWD	2.5i-L AWD	2.5i Premium AWD	2.5i-S AWD	Hybrid L AWD	Hybrid S AWD
Security						
Immobiliser security system	•	•	•	•	•	•
Instrumentation and Controls						
Adjustable steering wheel - height and telescopic	•	•	•	•	•	•
Electroluminescent gauges with colour MID	•	•	•	•	•	•
Instrument cluster	•	•	•	•	•	•
Manual mode	•	•	•	•	•	•
One touch lane change indicator	•	•	•	•	•	•
Paddle gear shifters	•	•	•	•	•	•
Sports pedals			•	•		•
Steering wheel controls:	•	•	•	•	•	•
Audio	•	•	•	•	•	•
Bluetooth ^{®2}	•	•	•	•	•	•
EyeSight [®]	•	•	•	•	•	•
MFD	•	•	•	•	•	•
MID	•	•	•	•	•	•
SI-Drive			•	•		•
Multi-Function Displays						
Multi-Function Display unit (MFD) featuring:	•	•	•	•	•	•
6.3" LCD screen	•	•	•	•	•	•
Air-conditioning display	•	•	•	•	•	•
Audio display	•	•	•	•	•	•
Driver Monitoring System ³ (DMS) display		•	•	•	•	•
Electrical component operating condition display	•	•	•	•	•	•
Energy flow display					•	•
EyeSight [®] display	•	•	•	•	•	•
Front View Monitor display		•	•	•	•	•
Fuel economy and journey information	•	•	•	•	•	•
Navigation display			•	•		•
Outside temperature and clock display	•	•	•	•	•	•

1. Subaru Australia reserves the right to change mechanical specification and equipment levels without notice. 2. Bluetooth[®] is a registered trademark of Bluetooth SIG Inc. System functionality is subject to the Bluetooth[®] wireless technology specification of individual device. 3. Driver Monitoring System performance and capability dependent on environmental and technical conditions. Refer to Owner's Manual for full details.

Subaru Forester features¹

MODEL	2.5i AWD	2.5i-L AWD	2.5i Premium AWD	2.5i-S AWD	Hybrid L AWD	Hybrid S AWD
Preventative Safety display	•	•	•	•	•	•
Side View Monitor display		•	•	•	•	•
X-Mode display	•	•	•	•	•	•
Twin trip meter (switchable)	•	•	•	•	•	•
Multi-Information Display unit (MID) featuring:	•	•	•	•	•	•
4.2" LCD screen	•	•	•	•	•	•
Auto Stop Start information	•	•	•	•	•	•
Bluetooth® ² phone display	•	•	•	•	•	•
Digital speedometer	•	•	•	•	•	•
Eco-gauge display	•	•	•	•	•	•
EyeSight® display	•	•	•	•	•	•
Fuel economy and journey information	•	•	•	•	•	•
Rear seat reminder	•	•	•	•	•	•
SI-Drive display			•	•		•
Tyre Pressure Monitoring System	•	•	•	•	•	•
Warning display	•	•	•	•	•	•
X-Mode display	•	•	•	•	•	•
Storage						
Cargo hooks	•	•	•	•	•	•
Cupholders – centre console	•	•	•	•	•	•
Cupholders – rear	•	•	•	•	•	•
Door pockets with integrated bottle holder – front and rear	•	•	•	•	•	•
Front centre tray	•	•	•	•	•	•
Overhead console – sunglass holder	•	•	•	•	•	•
Pull-out cargo area tie down points	•	•	•	•	•	•
Retractable cargo blind	•	•	•	•	•	•
Seat back pockets – driver and front passenger side	•	•	•	•	•	•
Convenience						
12V/120W power jacks (x3)	•	•	•	•	•	•
Boot/tailgate unlock on remote central locking keys	•	•	•	•	•	•
Intermittent variable speed front windscreen wipers	•	•	•	•	•	•

1. Subaru Australia reserves the right to change mechanical specification and equipment levels without notice. 2. Bluetooth® is a registered trademark of Bluetooth SIG Inc. System functionality is subject to the Bluetooth® wireless technology specification of individual device.

Subaru Forester features¹

MODEL	2.5i AWD	2.5i-L AWD	2.5i Premium AWD	2.5i-S AWD	Hybrid L AWD	Hybrid S AWD
Power mirrors and windows – driver and front passenger window with auto function	•	•	•	•	•	•
Powered tailgate			•	•		•
Power steering	•	•	•	•	•	•
Push open fuel lid	•	•	•	•	•	•
Rain-sensing front windscreen wipers	•	•	•	•	•	•
Rear seat centre armrest	•	•	•	Gloss black	•	Gloss black
Remote central locking keys (x2)	•	•	•	•	•	•
Smart key and push-start ignition	•	•	•	•	•	•
Sunvisor extensions	•	•	•	•	•	•
Sunvisors with illuminated vanity mirrors – driver and front passenger	•	•	•	•	•	•
USB charge port – rear passengers (x2)	•	•	•	•	•	•
Interior Trims						
Cargo area carpet colour – black	•	•	•	•	•	•
Carpet trim – black	•	•	•	•	•	•
Leather steering wheel and gear shift	•	•	•	•	•	•
Seat trim – cloth	•	•	Premium cloth		Premium cloth	
Seat trim colour – choice of black or platinum and black	•	•	•	•	Black only	Black only
Seat trim – leather accented				•		•
Shift boot	•	•	•	•	•	•
Seating Extras						
60/40 split folding rear seats	•	•	•	•	•	•
8-way power seat – front passenger			•	•		•
8-way power seat with dual memory – driver			•	•		•
Heated seats – driver and front passenger		•	•	•	•	•
Manual seat height lifter – driver	•	•			•	
One touch electronic folding rear seats			•	•		•
Reclining rear seat	•	•	•	•	•	•

1. Subaru Australia reserves the right to change mechanical specification and equipment levels without notice.

Subaru Forester features¹

MODEL	2.5i AWD	2.5i-L AWD	2.5i Premium AWD	2.5i-S AWD	Hybrid L AWD	Hybrid S AWD
Entertainment						
Auxiliary jack	•	•	•	•	•	•
Bluetooth ² wireless technology with:	•	•	•	•	•	•
Handsfree mobile communication	•	•	•	•	•	•
Audio streaming ³	•	•	•	•	•	•
Integrated infotainment system featuring:	•	•	•	•	•	•
6 speakers	•	•	•		•	
6.5" LCD touchscreen	•	•			•	
8 Harman Kardon ⁴ speakers, subwoofer and amplifier				•		•
8" LCD touchscreen			•	•		•
AM/FM radio	•	•	•	•	•	•
Apple CarPlay ⁵ and Android Auto™ connectivity ⁵	•	•	•	•	•	•
Digital radio ⁶ (DAB+)	•	•	•	•	•	•
Satellite navigation			•	•		•
Single CD player	•	•	•	•	•	•
Siri ⁷ compatibility	•	•	•	•	•	•
USB connection(s) – front centre console	(x1)	(x1)	(x2)	(x2)	(x1)	(x2)
Voice command recognition	•	•	•	•	•	•
Owner Benefits						
5 Year/Unlimited Km Warranty ⁸	•	•	•	•	•	•
8 Year/160,000 Km High Voltage Battery Warranty ⁹					•	•
5 Year/62,500 Km Capped Price Servicing Program ¹⁰	•	•	•	•	•	•
12 Month Roadside Assistance Program ¹¹	•	•	•	•	•	•

1. Subaru Australia reserves the right to change mechanical specification and equipment levels without notice. 2. Bluetooth[®] is a registered trademark of Bluetooth SIG Inc. System functionality is subject to the Bluetooth[®] wireless technology specification of individual device. 3. There may be restrictions on features available for certain models that are not fully compliant with AVCRP. 4. Harman Kardon[®] is a registered trademark of HARMAN International Industries, Incorporated. 5. Compatible Apple[®] or Android[™] device required. 6. Digital radio station coverage dependent on vehicle location. 7. Requires compatible Siri[®] enabled Apple[®] device to be paired with the infotainment system. 8. Every new Subaru comes with a 5 Year/Unlimited Km warranty period, unless the vehicle is used as a hire car, taxi, ride share, rental, driving school, delivery or courier vehicle in which case the warranty period is 5 years/150,000 kilometres (whichever occurs first). For full warranty terms and conditions, visit www.subaru.com.au/warranty. 9. The Subaru New Vehicle Warranty period on high voltage batteries for Subaru Hybrid vehicles is 8 years/160,000 kms, whichever comes first. 10. Every eligible Model Year 2020 onward Subaru Forester comes with Subaru's 5 Year/62,500 Km Capped Price Servicing Program. Available at participating Subaru Retailers only and does not apply to rental and some other classes of vehicles. For full Capped Price Servicing Terms and Conditions visit www.subaru.com.au/service/pricing/capped-price-servicing. 11. 12 Month Roadside Assistance Program is standard upon activation with relevant Motoring Club in each state. To receive this benefit the customer must opt into the 12 Month Roadside Assistance program at time of vehicle delivery. Eligible customers are those retail and novated lease customers who purchase a new Subaru on or after 1st June 2013 and have less than 5 vehicles under the Club Membership offer. Customers must provide a valid phone and residential address, as well as date of birth. Fleet, Government and Rental companies are excluded.



Forester 2.5i-S AWD

accessories for every adventure

We've got all the Genuine Subaru Accessories you need for your adventures. From bike and watercraft carriers to cargo pods, and a seat protector for the dogs. There's many ways to make your Subaru Forester fit you and your family even better.

- + Styling Tailor your Forester to your personal fit with a range of stylish interior and exterior options.
- + Protection Protect your Forester from a life of sandy feet, muddy paws and heavy luggage with a range of carpet or rubber mat sets, a cargo tray and a rear bumper cargo step panel.
- + Cargo and Tow To extend your Forester's towing and carrying capacity we offer a tow bar along with a broad range of Thule sport and cargo carrier accessories.
- + Security, Convenience and Safety Keep your new wheels secure with a security car alarm system. Park easily using Front Corner Parking Assist - sensors are automatically activated when reverse gear is engaged to guide you into tight spots.

Genuine Subaru Accessories are available from your Subaru Retailer, so be sure to ask about the range when buying your new Subaru Forester.



To view our complete range of accessories and pricing online visit www.subaru.com.au/forester/accessories



packs that will inspire you

From action-packed to packing the back, these quality Genuine Subaru Accessory Packs will give you the protection you need and versatility you desire to do more of the good stuff.

Both stylish and functional, each Accessory Pack has been custom made for a tailored fit to complement your Subaru Forester and keep it looking good for years to come.

Plus all Genuine Subaru Accessories are protected by our manufacturer's warranty¹.

Protection Pack includes:

a Carpet Mat Set

Enjoy the comfort with a luxurious Subaru branded quality carpet mat set.

b Cargo Tray

Throw all the gear in the back with a heavy duty mat to protect the cargo area from dust and dirt.

c Cargo Step Panel (Resin)

Grab your gear and go without worrying about scratching the rear top face of the bumper with a tailored resin panel.

d Mud Guard Set (Front)

Help protect the sides of your Forester from nasty stone chips with tailor made Mud Guards.

e Weather Shields

Sleekly designed and tailored to fit on to each door individually.

Explorer Pack includes:

Add a Tow Bar to the Protection Pack to squeeze more out of your everyday.

f Tow Bar

Hook your toys up to a functional and sturdy tow bar engineered specifically for Subaru vehicles and designed for optimum performance.



a



b



c



d



e

Weather Shields
(Part Number F0010SJ000) shown



f

1. For full warranty terms and conditions, visit www.subaru.com.au/accessories-information

protect your investment

Get out and do more while protecting your Subaru Forester from the rough and tumble of daily life. From our cargo tray to our bumper protector, each accessory is tailored for a perfect fit.

ACCESSORY		Part Number	2.5i AWD	2.5i-L AWD	2.5i Premium AWD	2.5i-S AWD	Hybrid L AWD	Hybrid S AWD
Styling								
1	Front Grille (Chrome)	J1010SJ200				•	•	•
2	Front Grille (Silver)	J1010SJ201	•	•	•			
3	Side Sill Plates	E1010SJ010	•	•	•	•	•	•
4	Bumper Under Guard (Rear) (Not applicable with Tow Bar)	E5510SJ000	•	•				
5	Centre Console Ultra Suede Side Trim	J1310SJ010	•	•	•	•	•	•
6	Ultra Suede Arm Rest	J1310SJ020	•	•	•	•	•	•
7	Front Dash Ultra Suede Trim Pieces	J1310SJ030	•	•	•	•	•	•
8	Centre Console Rose Gold Trim	J1310SJ110	•	•	•	•		
Protection								
9	Carpet Mat Set	J501ASJ000	•	•	•	•	•	•
10	Rubber Mat Set	J5010SJ000	•	•	•	•	•	•
11	Weather Shields	F0010SJ000	•	•				
12	Weather Shields (Chrome)	F0010SJ010			•	•	•	•
13	Mud Guards Front	J1010SJ001	•	•	•	•	•	•
14	Cargo Step Panel (Stainless)	E7710SJ000	•	•	•	•	•	•
15	Cargo Step Panel (Resin)	E7710SJ010	•	•	•	•	•	•
16	Rear Seat Pet Protector	F4110SG000	•	•	•	•	•	•

 To view our complete range of accessories and pricing online visit www.subaru.com.au/forester/accessories

	Not Applicable
•	Applicable



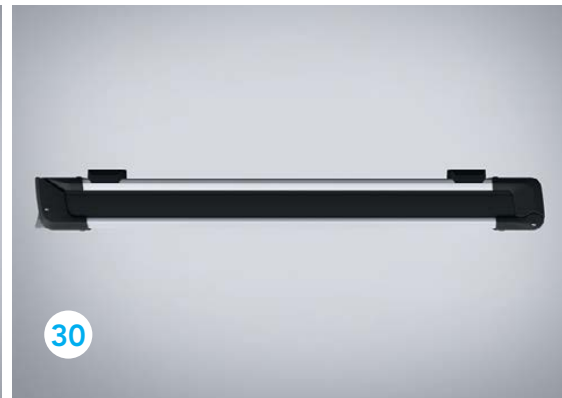
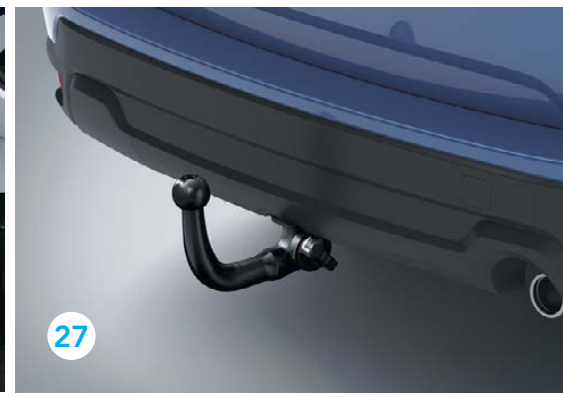
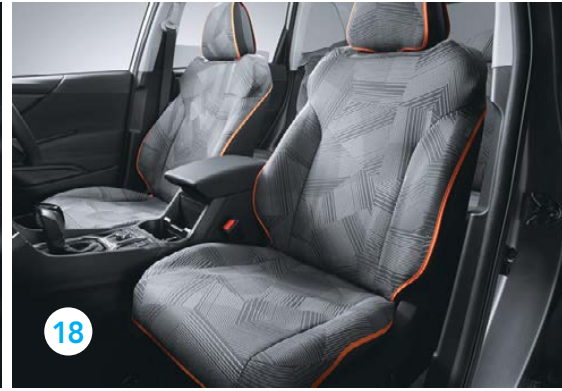

do all the things you've planned

Tow it, stow it or just pack more into your every day with a wide range of Subaru Forester compatible cargo options, plus premium Thule sport and cargo carrier accessories.

ACCESSORY		Part Number	2.5i AWD	2.5i-L AWD	2.5i Premium AWD	2.5i-S AWD	Hybrid L AWD	Hybrid S AWD
17	Front Black All Weather Seat Covers	F4110SJ000	•	•	•		•	
18	Front Stripe All Weather Seat Covers	F4110SJ010	•	•	•		•	
19	Rear Black All Weather Seat Cover	F4110SJ100	•	•	•		•	
20	Rear Stripe All Weather Seat Cover	F4110SJ110	•	•	•		•	
21	Bootlip and Bumper Protector	SAT6003	•	•	•	•	•	•
22	Headlamp Protectors	J101ASJ000	•	•	•	•	•	•
Cargo and Tow								
23	Roof Cross Bars	E365ESG000	•	•	•	•	•	•
24	Cargo Tray Mat	J501ASJ100	•	•	•	•	•	•
25	Forester Cargo Net	F551SSJ000	•	•	•	•	•	•
26	Forester Cargo Barrier	F551ASJ000	•	•	•	•		
27	Tow Bar	L101ASJ002	•	•	•	•	•	•
28	Lifestyle Awning Kit	SAT9020	•	•	•	•	•	•
Thule Roof Attachments and Accessories (Roof Cross Bars Required)								
29	Deluxe Ski Carrier – 4 Pair	SAT8023	•	•	•	•	•	•
30	Deluxe Ski Carrier – 6 Pair	SAT8024	•	•	•	•	•	•
31	Bicycle Holder – Silver (Upright)	SAT8018	•	•	•	•	•	•

 To view our complete range of accessories and pricing online visit www.subaru.com.au/forester/accessories

ACCESSORY		Part Number	2.5i AWD	2.5i-L AWD	2.5i Premium AWD	2.5i-S AWD	Hybrid L AWD	Hybrid S AWD
Thule Roof Attachments and Accessories (Roof Cross Bars Required)								
32	Bicycle Holder – Black (Upright)	SAT8019	•	•	•	•	•	•
33	Bicycle Holder (Fork Mounted)	SA1042	•	•	•	•	•	•
34	Ski Holder – 4 Pair	SAT9012	•	•	•	•	•	•
35	Ski Holder – 6 Pair	SAT9013	•	•	•	•	•	•
36	Surfboard Carrier	SA1139	•	•	•	•	•	•
37	Kayak Carrier – Dockglide	SAT9018	•	•	•	•	•	•
38	Thule Paddleboard and Mal Carrier	SAT8016	•	•	•	•	•	•
39	Roof Box – Thule Force XT M (Matte Black)	SAT5013	•	•	•	•	•	•
40	Roof Box – Thule Force XT L (Matte Black)	SAT5014	•	•	•	•	•	•
41	Roof Box – Thule Force XT XL (Matte Black)	SAT5015	•	•	•	•	•	•
42	Thule GoPack Set (4 bags for Roof Box)	SAT8030	•	•	•	•	•	•
43	Side Up Wheel Step	SAT9004	•	•	•	•	•	•
Security								
44	Wheel Lock Nuts	B327EYA000	•	•	•	•	•	•

 To view our complete range of accessories and pricing online visit www.subaru.com.au/forester/accessories



32



33

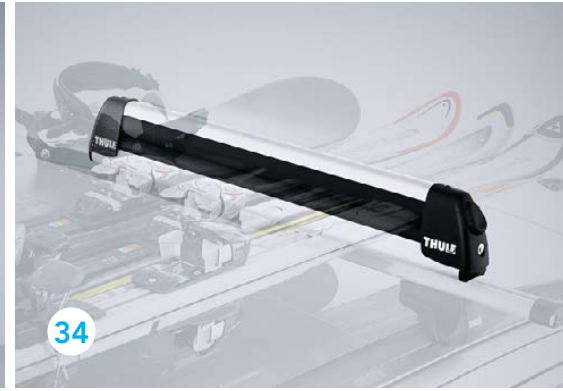

34



35

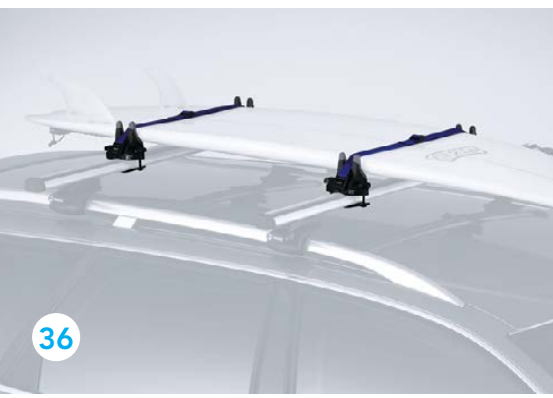

36



37



38



39



40

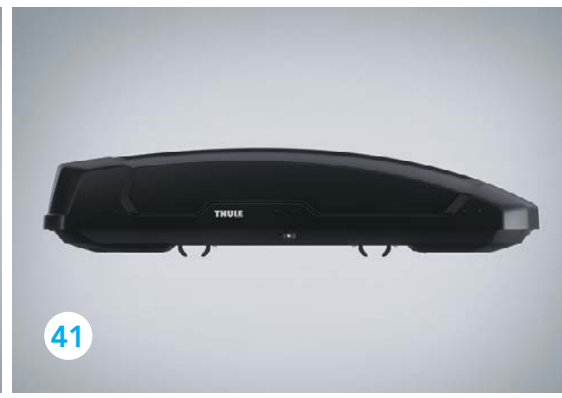

41



42



43



44



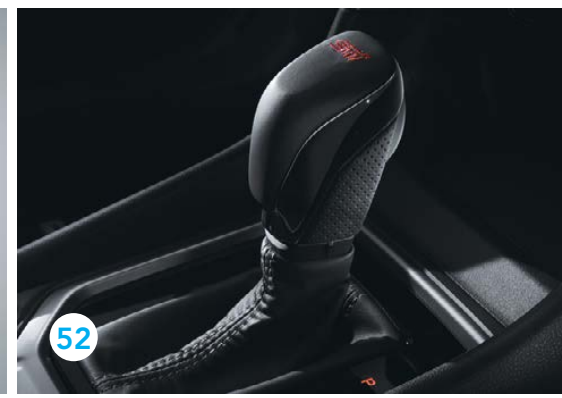

relax, we've thought of everything

From the simplest wheel lock nuts, to intelligent Front Corner Parking Assist, you can be sure we have you covered.

ACCESSORY	Part Number	2.5i AWD	2.5i-L AWD	2.5i Premium AWD	2.5i-S AWD	Hybrid L AWD	Hybrid S AWD
Convenience and Safety							
45	Front Corner Parking Assist	H481ASJ000##	•	•	•	•	•
46	Cigarette Lighter	H6710AL010	•	•	•	•	•
47	Garbage Box	J2010FL020	•	•	•	•	•
48	First Aid Kit	SM7001	•	•	•	•	•
49	Safety Triangle	SAT9007	•	•	•	•	•
50	Garmin Dash Cam 56 ¹	0100223111	•	•	•	•	•
51	Garmin Dash Cam Mini ¹	0100206210	•	•	•	•	•
STI Performance Parts							
52	STI Shift Knob CVT	C1010SJ000	•	•	•	•	•
53	STI Alloy Wheel Set (4) – 18in (Silver)	B3110SJ000K			•	•	•
54	STI Alloy Wheel Set (4) – 18in (Gun Metal)	B3110SJ010K			•	•	•
55	STI Alloy Wheel Set (4) – 18in (Black)	B3110SJ020K			•	•	•
56	STI Alloy Wheel Set (4) – 17in (Silver)	B3110SJ100K	•	•	•	•	•
57	STI Alloy Wheel Set (4) – 17in (Gun Metal)	B3110SJ110K	•	•	•	•	•
58	STI Alloy Wheel Set (4) – 17in (Black)	B3110SJ120K	•	•	•	•	•

1. Requires 8GB microSD™ card, Class-10 or faster (not included).

Denotes colour option of your choice.



To view our complete range of accessories and pricing online visit
www.subaru.com.au/forester/accessories





FORESTER

Forester 2.5i-S AWD

welcome to the family

There are cars that simply get you from A to B, and then there are cars that empower you. Buying a Subaru is like embracing life with both hands and knowing that nothing is going to stop you. When you buy a new Subaru you are welcomed into an owner's program that gives you access to a number of benefits.

Subaru New Car Warranty – 5 Year/Unlimited Kilometres¹

Every new Subaru purchased for private use is covered by a 5 Year/Unlimited Km manufacturer's national warranty. Visit www.subaru.com.au/warranty or ask your Subaru Retailer for more information.

Subaru Capped Price Servicing²

With our 5 Year/62,500 Km Capped Price Servicing Program, you'll now know the maximum amount you will have to pay for your next scheduled service during the Program period. You'll also have peace of mind knowing that specialist Subaru technicians will be looking after your pride and joy using only Genuine Subaru Parts.



1-Month Health Check and Chat

The 1-Month Health Check and Chat is a free consultation within the first month after delivery of your new Subaru. It allows our factory-trained technicians to provide quick vehicle checks, and one of our Service Advisors will answer any of your questions to help ensure an ongoing, worry-free experience.

Subaru's Map Updates³

If your new Subaru is fitted with a factory line fit navigation unit, your unit will be covered by Subaru's Map Update Program – guaranteeing you'll have access to the latest maps for the first 3 years of ownership.

Subaru Roadside Assistance⁴

Enjoy 12 months of Australia-wide, standard Roadside Assistance when you purchase your new Subaru. In the unfortunate situation where you need that extra helping hand, our Roadside Assistance will help with arranging a tow, battery service, flat tyre service, fuel delivery and lockout service.

1. Every new Subaru comes with a 5 Year/Unlimited Km warranty period, unless the vehicle is used as a hire car, taxi, ride share, rental, driving school, delivery or courier vehicle in which case the warranty period is 5 years/150,000 kilometres (whichever occurs first). For full warranty terms and conditions, visit www.subaru.com.au/warranty. 2. Every eligible Model Year 2020 onward Subaru Forester comes with Subaru's 5 Year/62,500 Km Capped Price Servicing Program. Available at participating Subaru Retailers only and does not apply to rental and some other classes of vehicles. For full Capped Price Servicing Terms and Conditions visit www.subaru.com.au/service/pricing/capped-price-servicing. 3. Subaru's Map Update Program is available on MY20 Subaru Forester models purchased from 27th February 2020 onwards with the factory line fit Gen3.1 navigation unit. Subaru's Map Update Program is not available on accessory fit or dealer sourced navigation units. Subaru Australia reserves the right to add and remove eligible vehicles at its discretion. For full terms and conditions of the Subaru Map Update Program visit www.subaru.com.au/owner-experience/benefits/subaru-map-update-program. 4. 12 month Club Membership and Roadside Assistance Offer is standard upon activation with the relevant Motoring Club in each state. To receive this benefit the customer must opt into the 12 month Club Membership and Roadside Assistance Offer at time of vehicle delivery. Eligible customers are those retail and novated lease customers who purchase a new Subaru and have less than 5 vehicles under the Club Membership offer. Customers must provide a valid phone number and residential address, as well as date of birth. Fleet, Government and Rental companies are excluded. Terms and conditions apply. For a full list of benefits, visit www.subaru.com.au/owner-experience/benefits/program/roadside.

live life without limits

Subaru Certified Collision Repairer Network¹

With a dedicated Subaru Certified Collision Repairer helpline available on 1800 737 179, help is available when you need it most. Available 24-hours a day, 7 days a week, help is only a phone call away. Subaru Certified Collision Repairers guarantee that trained specialists will repair your Subaru to strict factory specifications using Genuine Subaru Parts.

Genuine Accessories

Genuine Subaru Accessories are designed to enhance your vehicle, help you get more stuff done and have more fun! Our genuine accessories are factory approved by

Subaru and are protected by the Genuine Subaru Accessories Warranty. For our full range of Subaru Forester accessories visit www.subaru.com.au/forester/accessories. For more information on Genuine Subaru Accessories visit www.subaru.com.au/accessories-information.

Subaru Insurance²

It's important to enjoy the freedom of owning a Subaru, but it's also important to protect it. A range of Subaru Insurance options provides a variety of choices, including: Subaru Premier Motor Insurance and Subaru Extended Warranty Insurance.

Subaru Certified Used Cars

Every Subaru Certified Used Car has passed a 120-point quality inspection and comes with a one year unlimited kilometre Subaru Assured Warranty³ – to complement the balance of a new vehicle warranty or the statutory warranty that remains – from participating Subaru Certified Used Car Retailers.

1. Subaru Certified Collision Repairer network not available in all areas. Call 1800 737 179 or visit www.subaru.com.au/retailers to find your closest Subaru Certified Collision Repairer. 2. Subaru Insurance products are issued by Allianz Australia Insurance Limited AFS Licence No. 234 708 ABN 15 000 122 850 (Allianz). In arranging this insurance Subaru (Aust) Pty Limited ABN 95 000 312 792 (Subaru) and the authorised dealers act as agents of Allianz and not as your agent. Neither Subaru nor any of its related companies or appointed authorised retailers have any liability in respect of these policies. 3. The Subaru Assured Warranty product is issued by the selling Subaru Retailer. Subaru Australia has no liability in respect of this warranty.

Subaru Forester Awards

- 2018 - OzRoamer Car of the Year, AWD SUV \$40,000-\$50,000, Subaru Forester 2.5i-S AWD
- 2018 - Drive Car of the Year, Best Small SUV, Subaru Forester 2.5i-S AWD
- 2014 - Australia's Best Cars, Best AWD SUV Under \$45,000, Subaru Forester 2.5i
- 2013 - Australia's Best Cars, Best SUV Under \$45,000, Subaru Forester 2.5i
- 2013 - Australasian New Car Assessment Program 5 star ANCAP safety rating
- 2011 - Australia's best selling compact SUV, VFACTS 2008, 2009, 2010 and 2011
- 2009 - Best Compact SUV - Carsales Network People's Choice Award 2009, Subaru Forester
- 2008 - Best Compact SUV - Carsales Network People's Choice Award 2008, Subaru Forester
 - People's Choice Award - Drive 2008, Subaru Forester
 - Australasian New Car Assessment Program 5 star ANCAP safety rating for the entire Forester range
 - International Engine of the Year Award, 2.0 – 2.5-litre class, Subaru Forester XT (2.5-litre turbocharged horizontally-opposed Boxer engine)
- 2006 - Australia's Best Cars, Best Recreational 4WD, Subaru Forester X
 - International Engine of the Year Award, 2.0 – 2.5-litre class, Subaru Forester XT (2.5-litre turbocharged horizontally-opposed Boxer engine)
- 2004 - Australasian New Car Assessment Program 5 star ANCAP safety rating for the entire Forester range
 - Queensland Country Life, Queensland Country and Recreational Car of the Year, Subaru Forester 2.0XT
- 2003 - Australia's Best Cars, Best Recreational 4 Wheel Drive, Subaru Forester X
 - Australasian New Car Assessment Program 5 star ANCAP safety rating for the Forester XS Luxury (the best-ever rating for a compact ATW)
- 2002 - Australia's Best Cars, Best Recreational 4-Wheel Drive, Subaru Forester X
 - The Courier Mail, Queensland Car of the Year, Outstanding Recreational Vehicle, Subaru Forester X
- 2001 - Australia's Best Cars, Best Recreational Vehicle Under \$45,000, Subaru Forester Limited
 - The Courier Mail, Queensland Car of the Year, Outstanding Recreational Vehicle, Subaru Forester
- 2000 - Australia's Best Cars, Best Recreational Vehicle, Subaru Forester
 - 4x4 Australia, Best All-Wheel Drive, Subaru Forester
 - The Courier Mail, Queensland Car of the Year, Outstanding Recreational Vehicle, Subaru Forester
- 1999 - RACT Best Cars, TAS, Best Recreational Vehicle & Overall Winner, Subaru Forester
 - RACQ/The Courier Mail, QLD, Q-Car 1999, Best Recreational Vehicle & Overall Winner, Subaru Forester

Subaru Australia reserves the right to vary vehicle specifications and standard features in Australia from those detailed in this brochure. Vehicles shown in this brochure may be fitted with accessories available at additional cost. No part of the brochure can be reproduced without written permission from Subaru Australia. Printed in Australia.

www.subaru.com.au

© Copyright 2020 – Subaru (Aust) Pty Limited. All rights reserved.

Subaru (Aust) Pty Limited ABN 95 000 312 792 (Subaru Australia) PO Box 8311, Norwest NSW 2153 Toll Free: 1800 226 643



SUBARU