

CHEVROLET

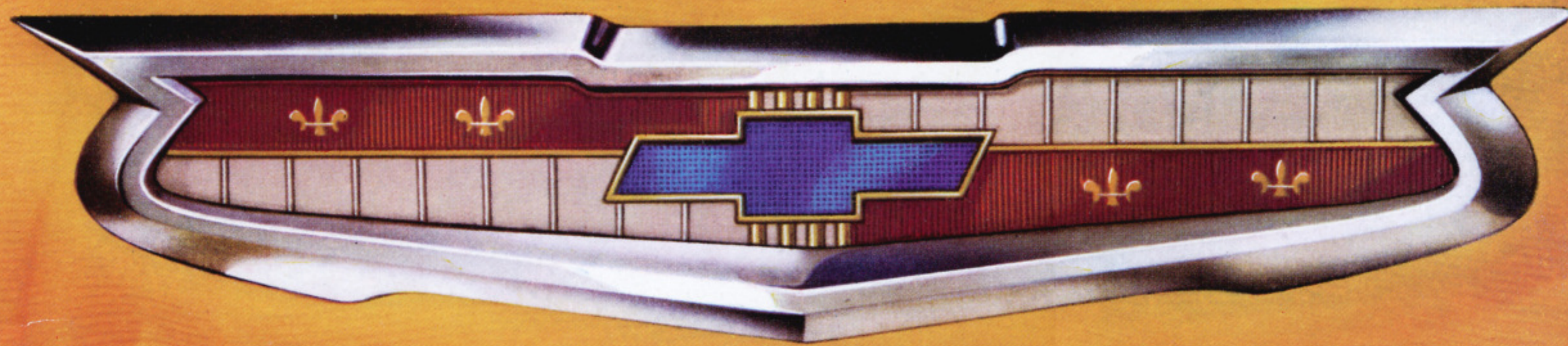

SWEET and SMOOTH with a luxurious new way of going places . . .

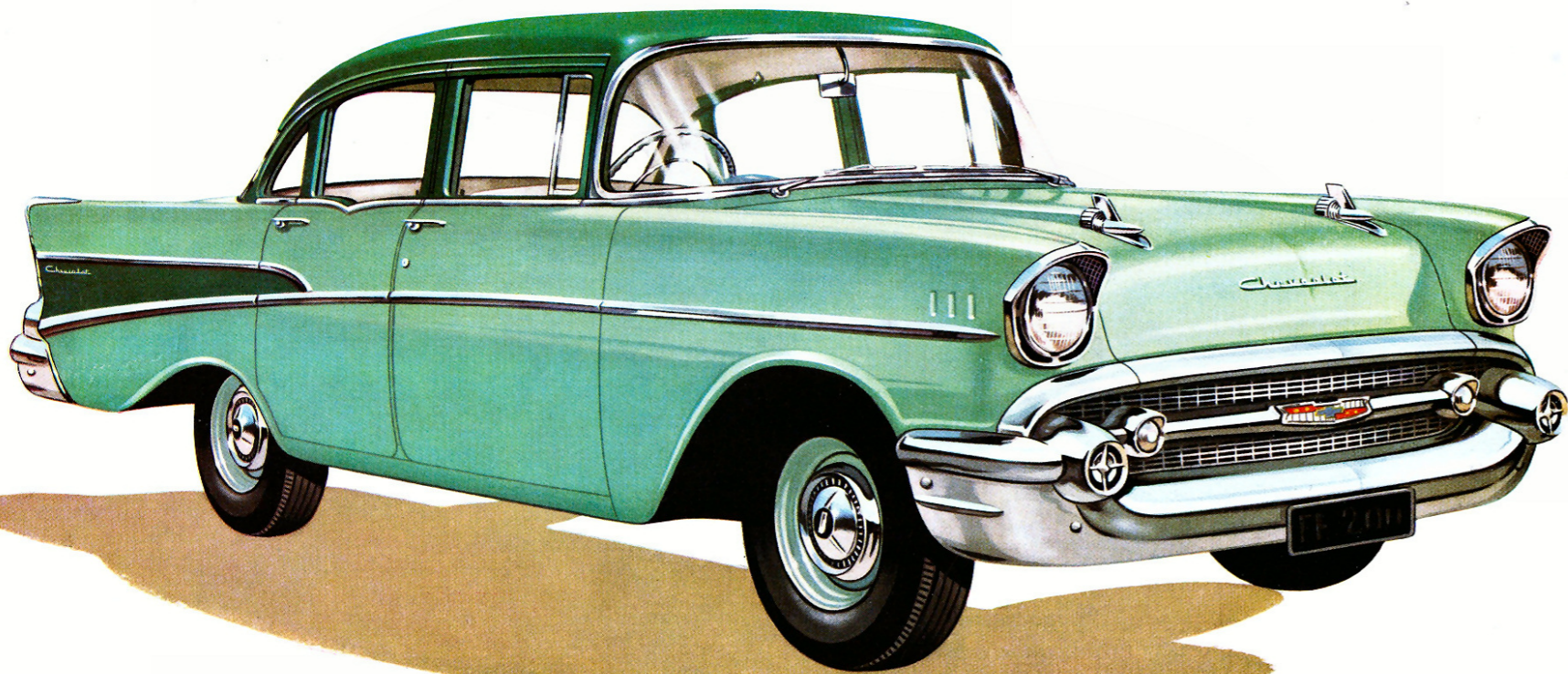

Filled with grace and great new features . . . that's the new Chevrolet. There's a lilt to Chevrolet's long, low-swept line that promises you unmatched handling, a promise Chevrolet keeps to the full. Lovely new styling from new front grille to new high-set rear fenders gives Chevrolet an air of excitement, with fresh new interior beauty emphasising the spacious luxury and comfort you expect of Chevrolet.

There are new luxury-size tyres and wheels, a new, smoother ride, and a new visibility for even safer driving . . . a solid certainty of control for easier, more comfortable handling over city street, highway or rough country track.





Solid beauty with a view to SAFETY

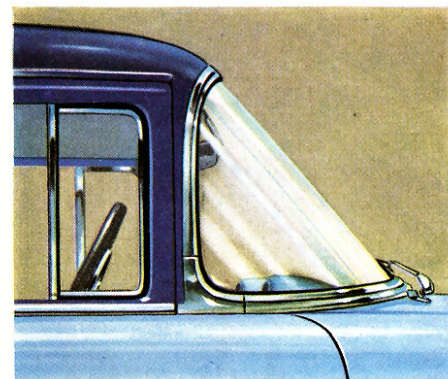

Beautiful focal point of Chevrolet's new styling, the sweep-sight windshield opening has been increased in size along the lower edge, giving you 69 square inches greater visibility . . . offering even greater safety than before, and greater ease when parking and travelling in packed traffic. With this new windshield and the large curving rear window you actually get full four fender visibility from the driving seat.

**CURVED INSTRUMENT PANEL.** Curving gracefully to follow the contour of the windshield, the instrument panel contains driving instruments in a hooded quadrant, placed for easy control right in front of the driver, and the glove box is in the centre of the panel . . . obviating the need for either you or your passenger to reach across to it. The smart off-centre steering wheel spokes radiating from the deeply recessed hub permit an unobstructed view of the instruments.

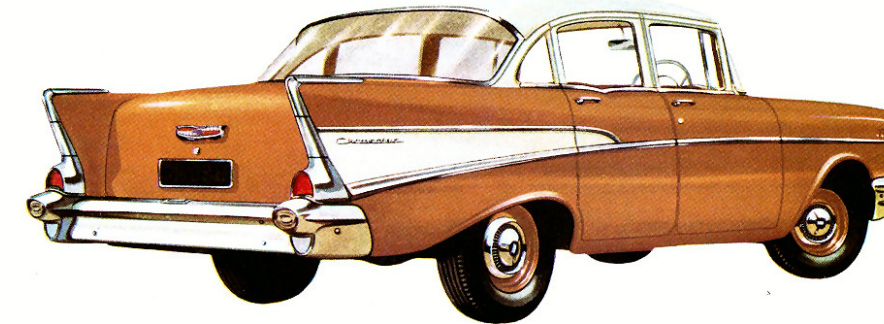

A new standard of beauty and luxury

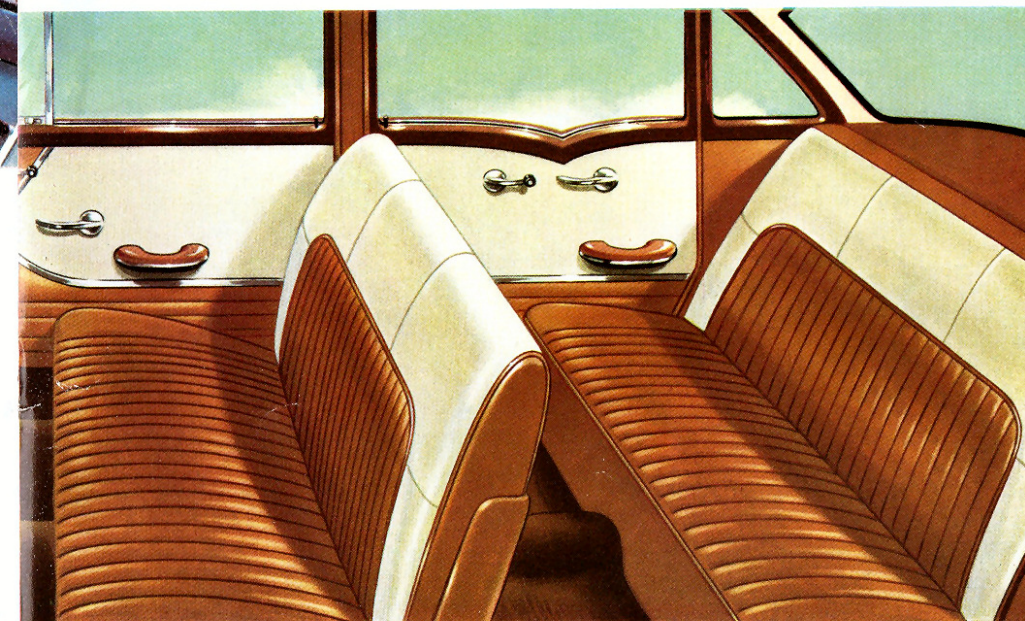

Chevrolet interiors reflect contemporary styling in new slender seats, glamorous leather upholstery and harmonious two tone colour decorations, setting a completely new standard of fresh beauty and comfort. Front seat backrests have been reshaped for greater passenger comfort. Armrests conform to interior colour styling, and also provide a handgrip for closing the door.

And all this roomy comfort and styling is surrounded by a safety-engineered body with brawny roof bow and massive roof rails.

#### HIGH VOLUME VENTILATION

Located in beneath headlight hoods, ventilation system air intakes are well away from the low lying dirt and heat of the road, assuring a comfortable supply of air at all times - making driving the great new Chevrolet a refreshing experience in every type of weather.

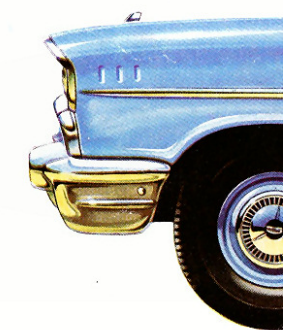

# Certain stability on every road . . .



Many new chassis features combine to give the new Chevrolet vastly improved handling, riding and braking qualities. Beautifully balanced, Chevrolet is smooth, sure and solid in action over any surface, its rugged chassis being the foundation of its down-to-earth roadability.



**BALL RACE STEERING**  
Low-friction ball bearing steering gives you a wonderful feeling of precise control wherever you turn.

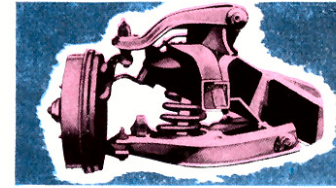

**GLIDE-RIDE FRONT SUSPENSION**  
Chevrolet's spherical joint design and *extra rugged* shock absorbers tame the roughest travel.



**NEW LOW PRESSURE TYRES**  
With new 7.50 x 14 tubeless tyres to absorb more road shock, Chevrolet gives you an even smoother ride.

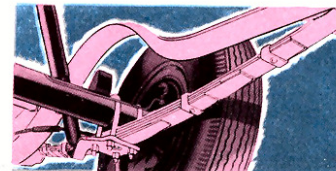

**OUTRIGGER REAR SPRINGS**  
The extra long rear springs are outside the frame to steady the ride and cushion drive shocks. New, more horizontal positioning gives better handling.

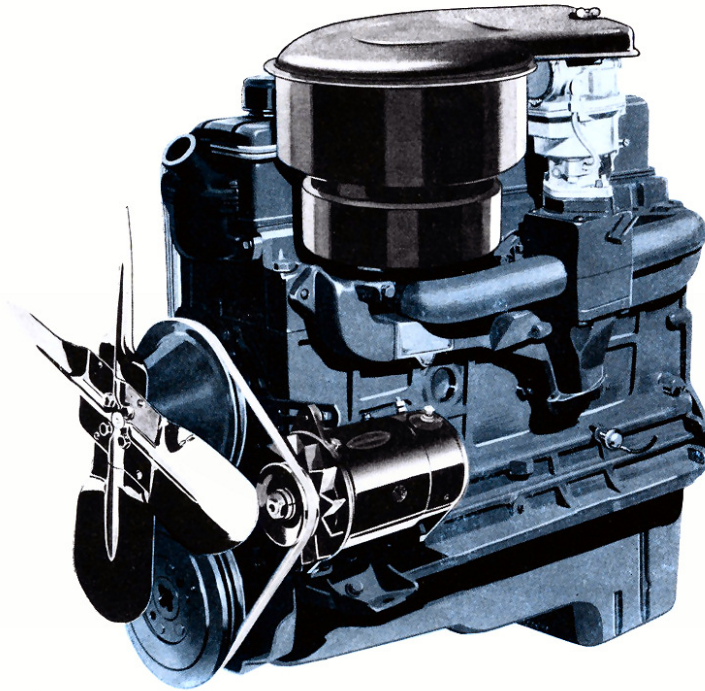

## The world's leading 6 cylinder engine

The reputation of Chevrolet's famous short stroke valve-in-head design has been built on outstanding performance combined with economy and dependability. Its 136 gross brake horsepower assures you of flashing performance and smooth acceleration at all speeds, and it has all the fuel economy you expect of Chevrolet. Immediately you take the wheel of a new Chevrolet you'll be conscious of the engine's eagerness to get up and go . . . and the effortless way it handles that going.

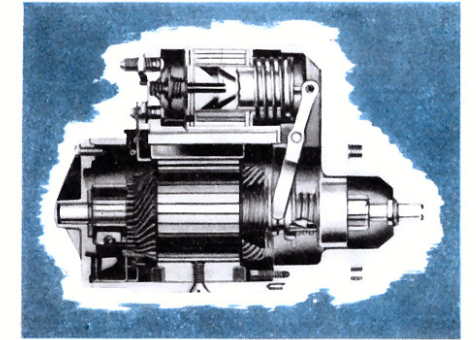

### IMPROVED STARTER MOTOR

The now completely enclosed starter motor protects the solenoid from accumulations of dirt. And fast starting is assured in the coldest weather.

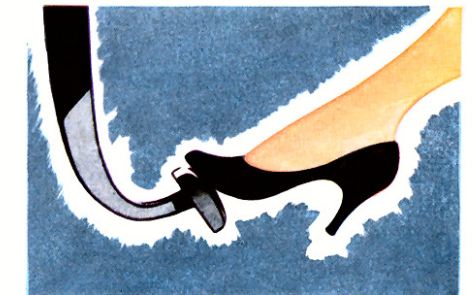

### GREATHER CLUTCH EFFICIENCY

Improvements in the diaphragm spring installation and in disc facings material have added to the efficiency of the proven Chevrolet clutch. Only light initial clutch pedal effort is sufficient for disengagement and this lessens as the pedal is depressed.

## GLAMOUR ACCESSORIES FOR YOUR CHEVROLET

A range of glamour Accessories is available for your new Chevrolet as optional extras.

A specially designed "Air Chief" Car Radio - the GMH car radio - has controls which harmonise with your instrument panel. "Air Chief" is the Car Radio approved and recommended by GMH engineers. It gives magnificent tone and clear reception wherever you travel.

Other Accessories for added beauty, safety and enjoyment include:

- Lovely Tailored NASCO Seat Covers in rich looking patterns.
- Automatic Windshield Washer.
- Venetian Blinds.
- Chromium Exhaust Extension.
- Visor Vanity Mirror.
- Anti-Glare Rear View Mirror.
- Licence Number Plate Frames.
- Car Heater.
- External Sun-Shade.

## SPECIFICATIONS

### POWER PLANT

ENGINE TYPE: 30.4 h.p. (R.A.C.) Valve-in-head. Six cylinders, 7.52:1 compression ratio. Max. gross B.H.P., 136 at 4,200 r.p.m. Max. Gross Torque, 204 ft. lbs. at 2,400 r.p.m. Cubic capacity 235.5 cu. ins.

PISTONS: Aluminium alloy with steel struts. Off-set piston pin.

CRANKSHAFT: Counter-balanced. Rubber floated harmonic balancer.

OILING SYSTEM: Full pressure to main, connecting rod, camshaft bearings, and timing gears; metered pressure to valve mechanism and cylinder walls.

FUEL SYSTEM: Single throat downdraft carburettor, with automatic choke, accelerating pump and fast idle mechanism. Oil bath air cleaner, silencer and flame arrester. Fuel mixture heated (thermostatic control) in manifold heat chamber. Tank capacity, 13½ imperial gallons.

COOLING SYSTEM: Capacity, 13½ quarts. Self-adjusting, permanently lubricated water pump with by-pass. Individually cooled cylinders, full length water jackets.

ELECTRICAL SYSTEM: Delco-Remy ignition system, includes centrifugal and vacuum spark-advance control. Octane selector. Ignition coil - high intensity spark for heavy duty ignition. High output ventilated Delco-Remy generator, with voltage and current regulator, Delco-Remy starter, with key turn starter switch.

POWER PLANT MOUNTING: Four point, dynamically balanced rubber cushioned mountings.

CLUTCH: Diaphragm spring type, ventilated. Permanently lubricated throw-out bearing.

TRANSMISSION: Synchro-mesh with helical gears throughout. Manually operated steering column mounted gearshift control.

### CHASSIS

FRAME: Box-girder type.

FRONT SUSPENSION: Independent front wheel springing, with direct double-acting hydraulic shock absorbers. Steering knuckles supported in spherical joints.

REAR AXLE: Semi-floating type with hypoid-drive gears of 3.55 to 1 ratio.

REAR SPRINGS: Semi-elliptic springs and shackles of compression type. Rubber insulated. Direct double-acting hydraulic shock absorbers.

DRIVE SYSTEM: Hotchkiss drive. Tubular propeller shaft.

BRAKES: Four-wheel self-energising hydraulic, 11 in. brake drums. Self-aligning full contact brake shoes. Mechanical parking brakes with T-shaped pull handle.

STEERING GEAR: Recirculating ball type. Fully adjustable. Ratio 20:1. Relay type steering linkage. Wheel diameter, 18 in.; two spoke with full circle horn blowing ring.

WHEELS AND TYRES: Five; steel disc with short spokes. 7.50-14 tyres on wide base rims. Tyre pressure, 24 pounds. Tubeless tyres.

WHEELBASE: 115 inches. Over-all length, 200 in. (including bumpers).

CHASSIS EQUIPMENT: Bumpers with two guards, both front and rear.

### LIGHTS - HORN - BATTERY

LIGHTS: Sealed beam headlamps with foot controlled beam indicator light on speedometer. Parking lights mounted at ends of grille horizontal centre bar. Dual tail and stop lights incorporating reflectors. Rear licence plate light. Dome light. Dual matched horns. Flashing turn signal lights front and rear.

CIGARETTE LIGHTER.

GLOVE COMPARTMENT LIGHT.

BATTERY: 12 volt, 9-plate 50 ampere-hour capacity.

INSTRUMENT PANEL - CONTROLS - VISION INSTRUMENTS: Speedometer. Engine temperature

and fuel gauges. Battery charge and oil pressure warning lamp indicators. Variable indirect instrument cluster lighting, rheostat controlled.

CONTROLS: Rubber padded foot controls. Illuminated 3 position ignition lock with key turn starting. Lights, air intake, windshield wiper control.

VISION: Single control dual 2 speed self-parking electric windshield wiper. Adjustable inside rear view mirror.

### BODY EQUIPMENT

Regular equipment includes the following:—

EXTERIOR: Stainless steel body belt line moulding. Curved panoramic windshield. Push-button door handles with key locks in both front doors. Petrol filler compartment immediately above left tail light.

INTERIOR: Seat cushions and squabs upholstered in two-tone leather with contrasting coloured inserts. Sponge rubber pads in both seat cushions. Individually controlled ventilators at either side of the dash. Venti-panels on front doors. Dome light controlled by lighting switch on instrument panel. Courtesy switch at each front door for automatic interior lighting. Two extensible sun visors. Instrument panel ash tray. Arm rests on doors, front and rear. Ash tray on back of front seat. Assist straps together with coat hooks located on rear roof rails.

Specifications and equipment subject to change without notice.

### G.M.A.C. CONFIDENTIAL HIRE PURCHASE

Convenient arrangements are available on your Chevrolet through General Motors' own company, G.M.A.C. Because General Motors' Acceptance Corporation is the largest hire-purchase institution in the world, it is able to offer low rental charges, and arrange a payment plan fitted to your individual requirements. Your local dealer can explain the G.M.A.C. plan and arrange payments to suit you.

### PROTECTIVE OWNER SERVICE POLICY

The General Motors-Holden's Ltd. Owner Service Policy protects you against defective workmanship or materials for 90 days or 4,000 miles of operation. You are also entitled to two thorough inspections and adjustments of your Chevrolet without charge. Chevrolet genuine spare parts and expert service available throughout Australia.

### GENERAL MOTORS-HOLDEN'S LIMITED

BRISBANE - SYDNEY - MELBOURNE - ADELAIDE - PERTH