

V A U X H A L L " 2 5 "

AS ENGLISH AS ENGLAND

METROPOLITAN DISTRIBUTORS:

MOTORS PTY., LTD.

324 WICKHAM STREET, BRISBANE

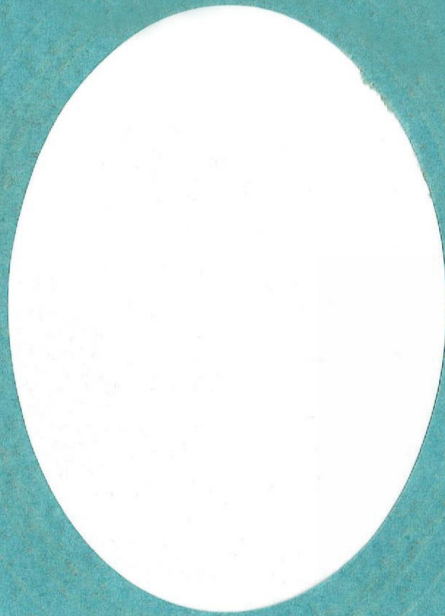

NO English manufacturer realizes so well as Vauxhall the Australian motorist's requirements. *None indeed is in a position to know them so well.* For, through its association with General Motors-Holden's Limited, Vauxhall enjoys what is tantamount to the possession of its own vast organization throughout Australia, its own constant on-the-spot contact with the Australian motorist in every State of the Commonwealth. The value of the co-operation between Vauxhall's English and Australian organizations has been seen in the sensationally-successful Vauxhall "14." Now it is demonstrated again . . . in the Vauxhall "25" . . . a car that examination will convince you, opens an entirely new chapter in the history of the English car in Australia.



*Modern as the moment
yet unmistakably in-
dividual because of
the famous fluting
that have distinguished
Vauxhall's bonnet
throughout a quarter
of a century of fine
car production.*

An English Car that Challenges World Competition **ON EVERY SINGLE POINT**

List all the features you demand in a car, and you will find the Vauxhall 25 incorporates every one. Speed and Acceleration! Vauxhall 25 has them in a degree you have to experience to appreciate (see Page 2). Hydraulic Brakes! Vauxhall has them too, and not merely hydraulic brakes but Dual-Safety Hydraulics. (Page 4.)

Riding comfort! No car can offer you more. For Vauxhall incorporates the very latest form of Independent Front Wheel Springing (the T.T. System described on Page 7). Beauty and Modernity! Vauxhall is distinguished by the Unisteel "Turret" Top Body (and what the "Turret" Top Body means in greater struc-

tural strength and comfort of travel, you can read on Page 6). So you will find it right down your list. Big major features and small refinements, the Vauxhall 25 has them all. Nothing is missing, nothing omitted. Here . . . for the first time . . . are *all* the features you want . . . in one great, medium-priced English car.

The Best in ENGINE DESIGN

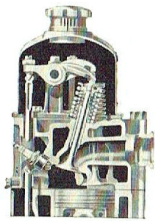

In planning their new 25 H.P. Engine, Vauxhall engineers set up new ideals of power and acceleration combined with smoothness and economy. They aimed high—and attained their objective.

They sought the perfect Combustion Chamber . . . one in which combustion would be fully progressive . . . and achieved it by developing a special machine to enable them to study the burning of fuel in model combustion chambers.

They aimed at maximum efficiency of compression . . . and attained it with Oval-Ground Pistons. Circular pistons do not expand in a perfect circle, so Vauxhall engineers evolved a special method of grinding pistons so that they are slightly oval when cold, but expand to practically perfect circles when the engine is running. To minimise the loss of compression in many engines due to "valve bounce," Vauxhall provided Double Valve Springs, one of which acts as a shock absorber, and checks the valve's tendency to keep on bouncing after it has impacted the seat.

To secure the full benefits of the new combustion chamber and better compression sealing, Vauxhall engineers next turned their attention to improve vaporization. To do this they not only provided a carburettor so responsive to engine requirements that it weakens or enriches the mixture exactly as necessary, but they provided a thermostatic conditioning of the mixture as it passes through the induction manifold. When the engine is cold, the heat from the exhaust gases is used to warm the ingoing mixture, a control valve automatically allowing the heat to blow off when the engine warms up.

(Continued in right-hand column)

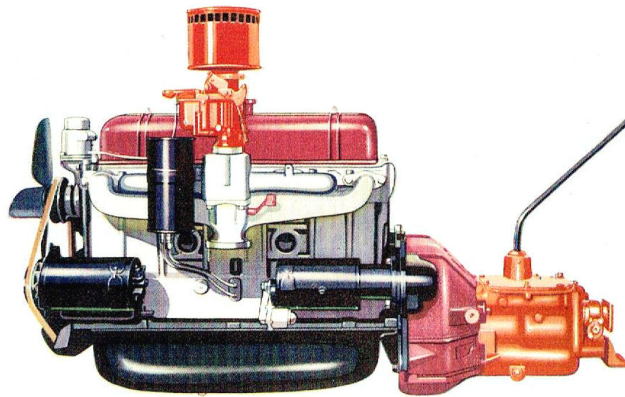

(Continued from left-hand column)

Satisfied with the design of their engine as regards combustion and compression, the next care of Vauxhall engineers was to ensure that the power so developed should be converted into a smooth flow, and to do this they adopted a Crankshaft so perfect of balance that if it is supported on two knife edges a piece of plasticine the size of an ordinary pea stuck on either side will cause the shaft to turn. To this exactly balanced crankshaft, Vauxhall added a Crankshaft Vibration Damper as a final refinement of engine smoothness. By means of this Damper the separate power impulses from the pistons merge into one smooth flow.

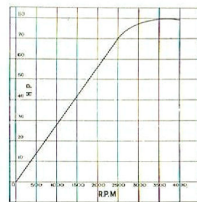
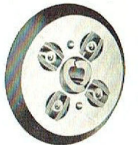

See how fast this new O.H.V. engine develops power . . .

No need to be an engineer to read the story of quick power-development in the power curve of Vauxhall's 25 H.P. Engine. Here is proof, not just promises, of flexibility and acceleration. In the Vauxhall 25 there's a spirited eighty horse power at your command . . . ready to send you surging forward at a smooth eighty miles an hour should the need arise. At ordinary cruising speed . . . forty . . . fifty . . . sixty . . . you're just loafing—and you are pleasantly aware of it. Here's power a-plenty to do everything easier, effortlessly, with never a hint of strain in the engine . . . a power that is untaxed and unflinching in the face of the stiffest grades with the most tortuous turns. Some of the features which contribute to the sparkling performance of this new Vauxhall Engine are briefly described on this page. Others have had to be merely listed. Even were this entire catalogue devoted to a description of the Vauxhall Engine however, it still would be inadequate. There is only one way to appraise the eager responsiveness and smoothness which Vauxhall engineers have built into this new engine . . . BY TAKING THE WHEEL . . . as Vauxhall Dealers gladly invite you to do.

To transmit that flow of power to the drive shaft, Vauxhall adopted a new Centrifugally Loaded Clutch. At high speeds, when the most positive engagement of the clutch is necessary, the Centrifugally Controlled clutch fingers supplement the clutch springs so that the clutch faces grip with a double assurance against slip and loss of power. At slower speeds when the additional action of the clutch fingers are unnecessary, the clutch springs

alone function, so that the clutch is light and does not bring about undue driving fatigue. These, of course, are only high lights of the new Vauxhall 25 H.P. engine. There are many points which cannot be described here, features such as the following, contributing either to performance, economy or long life:

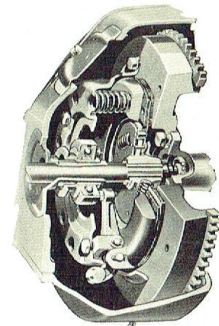

Exhaust valves of non-burn steel . . . Spray cooled valve seats . . . Economy adjustment ignition . . . Large water capacity . . . Full depth water jackets . . . Thermostatically controlled radiator . . . Full pressure lubrication

The Best in BODY APPOINTMENTS

- *Armourplate Safety Glass in all Side Windows as well as Windscreen.*
- *Roomy Inbuilt Luggage Trunk.*
- *Separate Spare Tyre Compartment.*
- *Improved No-Draught Ventilation.*
- *New-type Adjustable Driver's Seat.*
- *Electric Windscreen Wipers (Dual).*
- *Iridescent Tenite Interior Handles.*
- *Relax-o-form Seats.*
- *Glove Box.*
- *Provision for Radio.*
- *Two-way Sun Visors (2).*
- *Visor Vanity Mirror.*
- *Corded Silk Rug Strap.*
- *Carpeted Footrest.*
- *New, tasteful treatment of upholstery.*
- *Conveniently Adjustable Steering Wheel.*
- *Large Cowl Ventilator with insect screen.*
- *Armrests in both front and rear.*

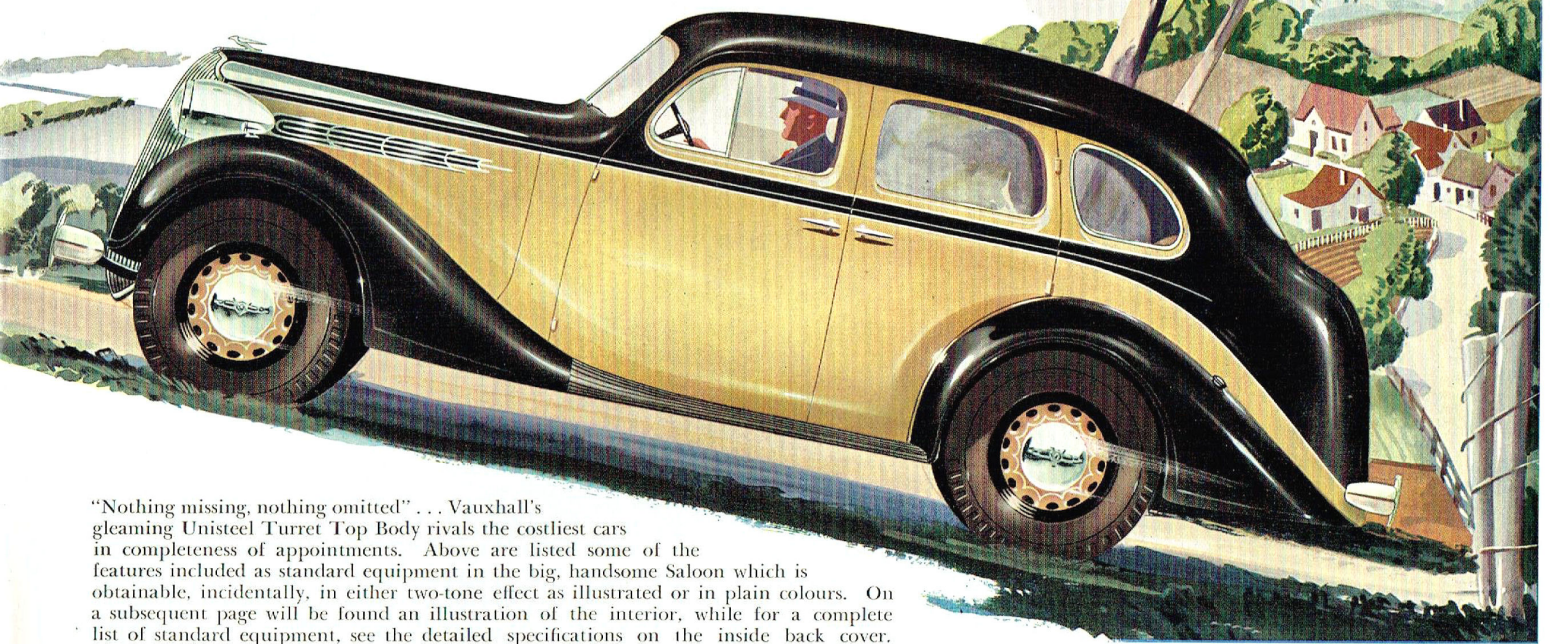

"Nothing missing, nothing omitted" . . . Vauxhall's gleaming Unisteel Turret Top Body rivals the costliest cars in completeness of appointments. Above are listed some of the features included as standard equipment in the big, handsome Saloon which is obtainable, incidentally, in either two-tone effect as illustrated or in plain colours. On a subsequent page will be found an illustration of the interior, while for a complete list of standard equipment, see the detailed specifications on the inside back cover.

The Best in SAFETY FEATURES

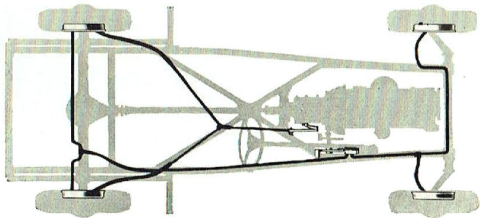

"ARMOURPLATE" GLASS IN
ALL SIDE WINDOWS AS WELL
AS THE VEED WINDSCREEN

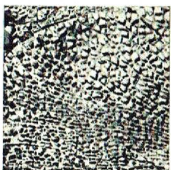

Vauxhall supplements the protection of its rigid Unisteel body with "Armourplate" Safety Glass in all side windows as well as the windscreen. You can drive with confidence in the Vauxhall "25" free of the haunting fear of the flying fragments of glass that can follow even quite a minor accident when car windows are of ordinary glass. "Armourplate" glass is immensely strong, proof of which is the fact that the British Board of Trade (a very conservative body) permits "Armourplate" Safety Glass of one inch thickness to be used to replace ordinary plate glass of one-and-a-half inch thickness in portholes of ships where the glass has to withstand terrific pressures. Even though "Armourplate" Safety Glass will break under a violent blow, there is no splintering. The whole pane of glass simply crumbles into countless, tiny blunt-edged pebbles of glass and tumbles harmlessly from the frame. Non-laminated "Armourplate" Glass is guaranteed to remain always crystal clear, and does not cause irritating distorted vision.

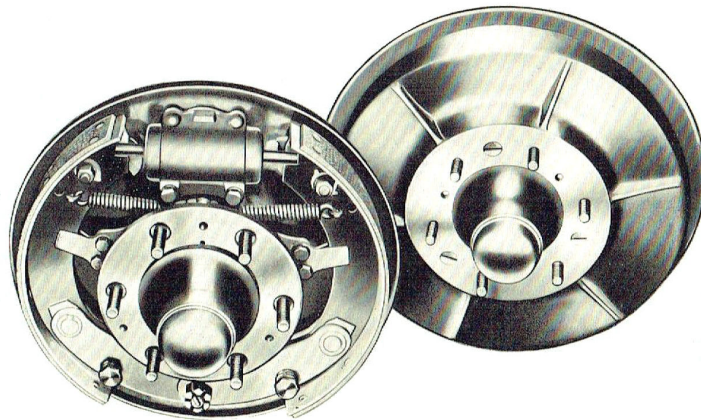

Note the design of the brakes which have self-energizing shoes, reducing the amount of pedal pressure necessary. The brake linings are of extra thickness to give long life, while the shoes are adjustable to take up wear simply by turning two exterior nuts on each brake drum dust shield. The drums are of cast iron ribbed for heat dissipation and to prevent distortion.

You're doubly safe with Vauxhall DUAL SAFETY HYDRAULIC BRAKES

Vauxhall were not content to incorporate simply Hydraulic Brakes. They insisted on Dual Safety Hydraulics. Briefly explained, the advantage is this: Front and rear wheels operate normally as one, but in the unlikely event of a leakage in either front or rear pipe lines, you are not left entirely dependent on your handbrake, either front or rear wheel brakes being able to operate independently of each other. As you see from the diagram, the pipe lines from front and rear wheel systems enter the Master Cylinder independently. Within the Master Cylinder are two pistons, a primary and secondary, for rear and front wheel brakes respectively. When the brake pedal is depressed, the primary piston compresses the fluid in the rear pipe lines, at the same time forcing the secondary piston to similarly affect the fluid in the front pipe lines. Should a leakage occur in the rear lines, the primary piston would be pushed by the pedal mechanism in the ordinary way till it contacted the secondary piston, and pressure would thus be built up in the front pipe lines. If the leakage were in the front pipe lines, the primary piston would exert pressure through the rear lines while pushing the secondary piston to the end of its travel and sealing the entrance of the front pipe line system. Thus the brakes on either front or rear wheels always remain fully effective.

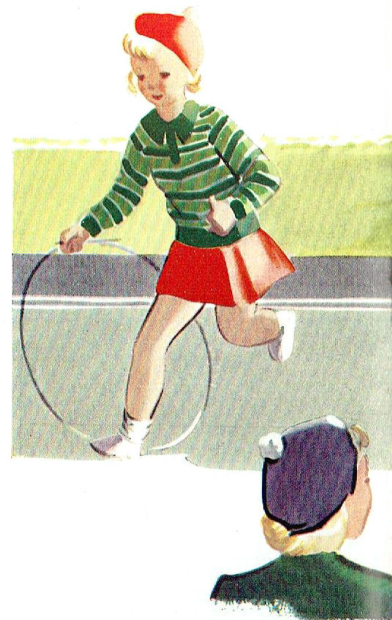

The Best in COUPE DESIGN

THE ORIGINAL HOLDEN
DESIGNED ALL-ENCLOSED
COUPE NOW EVEN MORE
OUTSTANDING BECAUSE OF
ITS UNISTEEL BODY WITH
GLEAMING "TURRET" TOP.

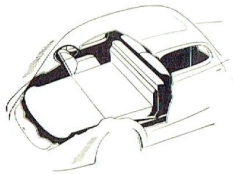

Owners in hundreds have proved the dual-purpose utility of the Holden All Enclosed Coupe. It is the ideal body for those who drive alone or with a single companion most of the time, but who wish on occasions to carry additional passengers in comfort. And it is a body that is simply built to order for those who carry large amounts of luggage or use their car for business purposes. When more luggage accommodation is required than provided by the luggage compartment, the rear seat can be lowered. The back of the car thus becomes one huge luggage compartment which can be loaded through a door in the rear panel.

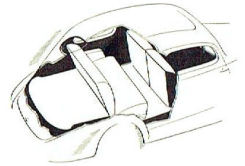

The Best in BODY CONSTRUCTION

THE NEW BODY BY HOLDEN
THAT IS JUST WHAT ITS
NAME IMPLIES—UNISTEEL—
ONE UNYIELDING SOLID
STRUCTURE OF STEEL.

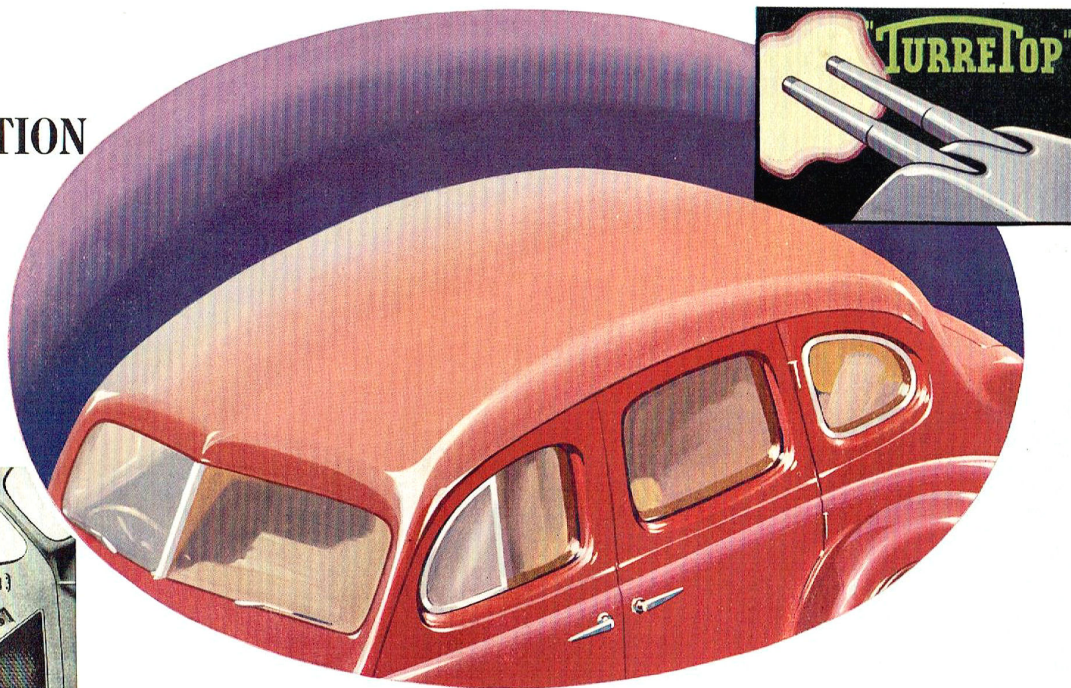
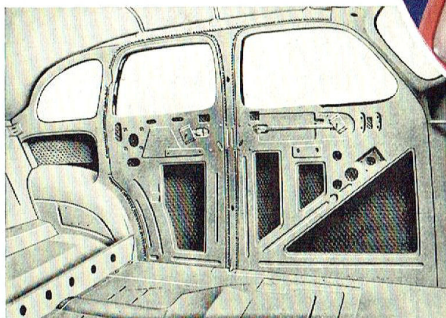

UNISTEEL BODY BY HOLDEN WITH TURRET TOP

Look at the sectional view above, and you will see that this Unisteel Body by Holden is all steel throughout, just as the name implies. Overhead is the one piece *all-steel* Turret Top, arched and crowned for the greatest possible strength, and braced with *steel* cross bows. Underneath is the solid *steel* floor. Front and side pillars are *steel* again. The frames of the doors and their panels, *all* are of steel.

Walk up to this new Unisteel Body. Open one of its big doors. Slam it—*hard*. Hear that deep solid sound? It's the most substantial sound in

1937 cars—the new solidity of outer and inner steel door panels, steel hinges, steel pillars, and steel cowl. Next step on the running board and look over that Turret Top. Note the unyielding rigidity of that seamless crown of steel. Now get into the car. Stamp on that solid steel floor. Here is the same welcome strength of a body in which floor, cowl panels and roof are one integral structure, welded at all joints, without the use of a single bolt, screw, rivet or nail. Finally, take your place at the wheel and note how weaving and body-squeaking are banished.

Floor, roof and sides of this new Unisteel body are all insulated against sound. You ride relaxed and rested . . . enclosed in silence . . . in a luxury you have never before experienced in any car . . . of any cost.

This new Unisteel body of the Vauxhall 25 is the greatest advance in motor car construction today. It means new safety, new comfort . . . and new long life for your car, for built on to the chassis, it braces it and assists it to resist the shocks and torsional strain that are exerted on your car with every hundred yards you drive.

The Best in CHASSIS SPRINGING

STILL FURTHER ENHANCED
... THE BILLIARD-TABLE
RIDE THAT ONLY "KNEE-
ACTION" CAN GIVE.

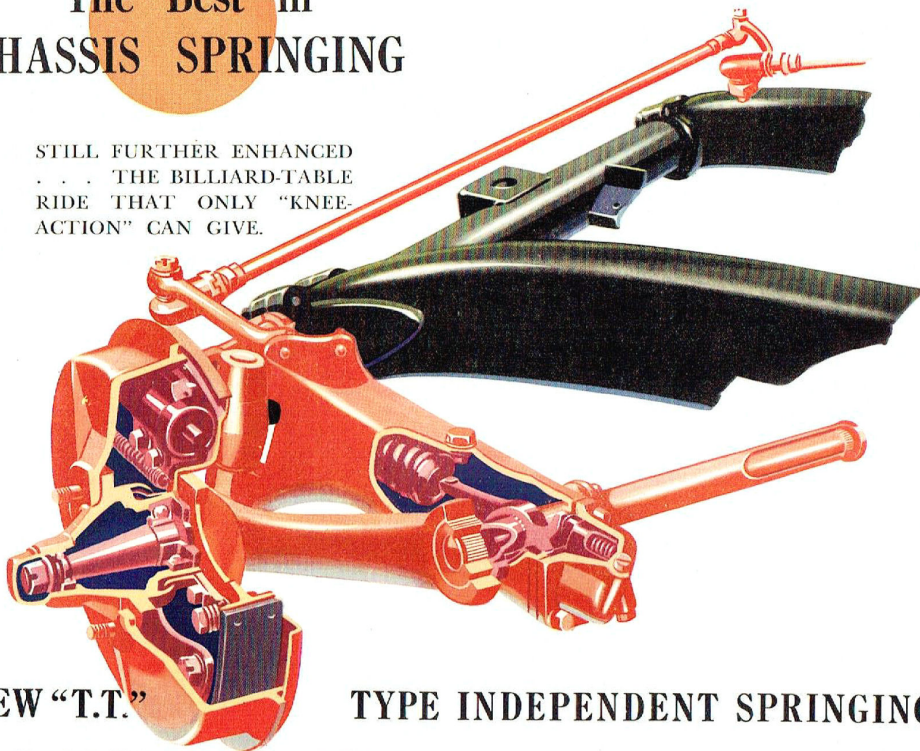

NEW "T.T." TYPE INDEPENDENT SPRINGING

The Vauxhall 25 incorporates a type of Independent Front Wheel Springing with important new features. The system has been called the T.T. type because it embodies a torsion bar and torsion tube and possesses these advantages:

Firstly all working parts are completely enclosed and operate in an oil-bath. Secondly the system provides soft springing for good roads and stiffer springing for bad ones. Thirdly the T.T. system builds up a rapidly increasing resistance to rolling on corners. Fourthly, as the front

wheels move up and down, they alter their camber, adding to the stability of the car, aiding the steering and giving longer tyre life. As you can see from the illustration, the wheel carrier arm on which the wheel moves up and down, is fixed to a torsion bar which then passes through a torsion tube at the end of which it is rigidly fixed. As the wheels rise and fall with the irregularity of the road surface, they try to twist the rod and tube. The wheels are assisted in this action by a powerful coil spring which

**What an endorsement of the Safety
of Independent Springing**

"Independent wheel suspension now finds a place on every European racing car built for this season's events, or under construction."
—*Automotive Industries.*

•

**What a Proof that it is superseding
Conventional Springing**

Twelve cylinder Rolls Royce announced. "It is interesting to find that the most conservative factory in the world has adopted independent front wheel suspension indicating that the principle has been accepted as definitely proved."
—*Melbourne Herald.*

bears on to a toggle, which is set at right angles to the torsion bar. Thanks to the action of this coil spring the flexibility of the action is excellent. On rough roads however where the movement of the wheels is greater, the torsion bar twists and removes the toggle beyond the effective limit of the coil spring. Springing is thus "stiffened." The effect of this dual-rate springing in conjunction with the double-acting hydraulic shock absorbers is to give the utmost in comfort under all road conditions.

The Best in INTERIOR DESIGN

A LUXURY NOT ONLY IN
FEATURES YOU CAN SEE AND
TOUCH . . . BUT IN QUALITIES
OF RESTFULNESS AND
SILENCE THAT YOU CAN
FEEL AND HEAR

You can touch and examine evidences of luxury on every side of you in the Vauxhall "25" Saloon. You can adjust the No-Draught Ventilation for instance to fan your cheek with the breeze, or bring you draughtless ventilation that will not disturb a hair of your head. You can admire the Temite Door Handles . . . and test the comfort of the soft-leather Relax-o-form Seats. You can explore the pockets in all doors . . . and adjust the front seat and steering wheel to your utmost comfort. But there are other features which you cannot see or touch . . . but which you will very definitely *feel* when you enter the Vauxhall "25" Saloon. As you close the door, you shut out noise. You are in a world apart . . . one that is bright and airy yet so scientifically sound-proof that the traffic roar around you dies to a whisper. Here is a silence that is actually *measurable* . . . that indeed has been measured at Holden's by means of the wonderful Scientific Ear which has made it possible for body engineers to track down the source of noise, and by scientific methods, to eliminate 70% of it.

Note incidentally the improved design of the No-Draught Ventilation System in the front window. The chromium strip which seals the space between the two sections of glass, lowers with the window. Vision is assisted, while the new design enables the driver to lean out through his window when parking in confined spaces, etc.



Adjustable Wheel and New Type Adjustable Front Seat

The driver of a Vauxhall "25" can adjust both the Steering Wheel and the Front Seat so exactly to his comfort that it is almost as if the car were made to his individual measurements. By an ingenious device developed by Holden's, the front edge of the seat automatically lowers itself as the seat is pushed forward, a boon to those of below average height. Reversely, when the seat is moved back, the rear of the seat is lowered and the front rises so that a more inclined position than normal is offered, a distinct comfort to tall people.



The Utmost in VALUE

AS YOU CAN QUICKLY VERIFY
FOR YOURSELF BY SCANNING
OVERSEAS CAR ADVERTISEMENTS

You buy better when you buy a Vauxhall . . . firstly because it is English with the tariff even more in its favour to-day than in the past. Price comparisons, even with other similarly favoured English cars, are overwhelmingly in Vauxhall's favour. You have only to scan any English Motoring Magazine and compare English with Australian prices to realise that there is less price increase on Vauxhall than on any other English car. The reasons for Vauxhall's more competitive pricing is twofold. Firstly, because it is an associate of General Motors-Holden's Limited, who possess unapproached facilities for chassis assembly and body construction in Australia. Secondly, Vauxhall is marketed more economically because it is distributed and serviced through the Australia-wide organization of General Motors-Holden's Limited. With the biggest sales of any English car in Australia, Vauxhall's overhead per unit is thus considerably lower. By any standards Vauxhall represents outstanding value for money.

You enjoy other advantages too because of Vauxhall's association with General Motors-Holden's Limited. You can acquire your Vauxhall under the G.M.A.C. Confidential Payment Plan through General Motor's Acceptance Corporation, which is the largest Hire Purchase Institution in the world, and is thus able to offer you low rental charges and to arrange a payment plan fitted to your individual requirements.



You have the assurance too of General Motors-Holden's Owner Service Policy which protects you for ninety days or 3,000 miles of operation. And finally you enjoy the benefits of service and spare parts facilities that are the most extensive of any English Car in Australia.

ADD THESE ACCESSORIES WHEN YOU BUY YOUR VAUXHALL "25"

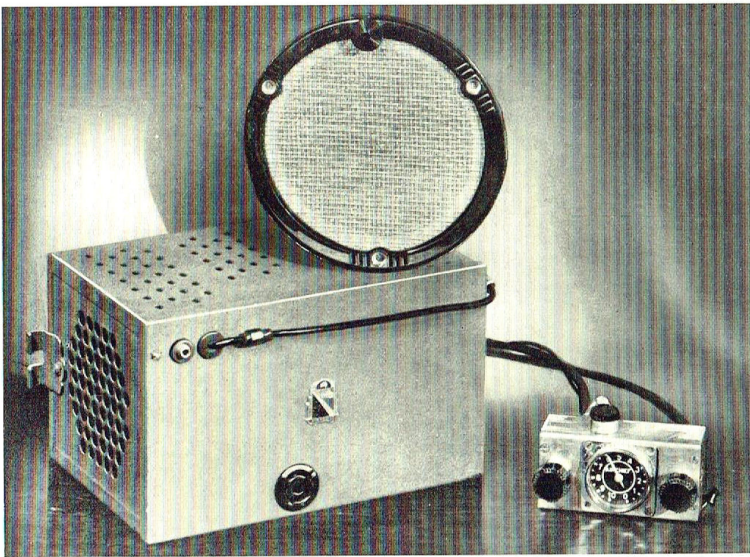

Air Chief Car Radio

The air is full of programmes you want to hear . . . music, sporting results, market and weather reports. Enjoy them as you travel through the magic of "Air Chief" Car Radio. The 2-unit "Air Chief" Radio gives remarkable sensitivity, less fading, longer distance daylight reception, improved tone and volume and combines a special filter which makes spark plug suppressors unnecessary. The 2-unit "Air Chief" incorporates one triple purpose and one double purpose valve, thereby giving 9-valve performance with the use of only 6 valves. The receiver fits snugly behind the dash, the controls being mounted handily on the instrument panel. The speaker fits to the header-bar flush with the lining of the roof, and gives you the advantage of head-height reproduction. You can buy the "Air Chief" Radio and include it under the same convenient payment plan as your new Vauxhall "25."



DOOR-EASE is a clean, dry stick of solidified lubricant for use on doors and other parts of the body. It will not run, smear, stain or collect dust.

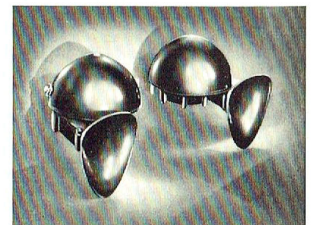

MATCHED HORN SET for underhood mounting. Gives a non-irritating warning in traffic; on the open road its full volume can be heard far off.



INSPECTION LAMP for wheel changing, engine inspection, etc., at night. Plug in and base of lamp is magnetised, adhering to all ferrous surfaces.

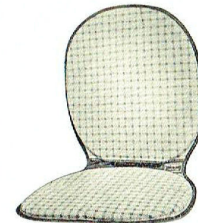

The "KOOLKOOSHION" ends that hot, sticky feeling which often makes summer motoring a discomfort. Air circulates freely through its weave.

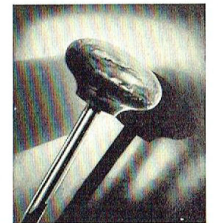

DE LUXE GEAR LEVER KNOB adds another touch of beauty to your car's interior. It will not chip or crack, and remains pleasant to the touch.

Unillustrated

GM-H DUCO CLEANER AND POLISH does two jobs in a single operation—and does them well. First it removes the traffic film which dulls the brilliant finish of the ducro. Then it produces a mirror like gloss which restores the ducro to its showroom finish. GM-H Cleaner and Polish has been developed only after exhaustive tests by General Motors-Holden's Ltd. It is available in 8 oz. and 16 oz. sizes.

FENDER MARKERS are a boon to both novice and experienced drivers, saving many a scraped guard. For parking in the city or garaging your car where you have a confined entrance, fender markers are a guide that can easily be seen without craning forward over the steering wheel. The attachment to the mudguard is secure and fitting can be made by any garage or by the owner in a few minutes.

Senior Car of the Vauxhall Line
VAUXHALL 7 PASSENGER SALOON

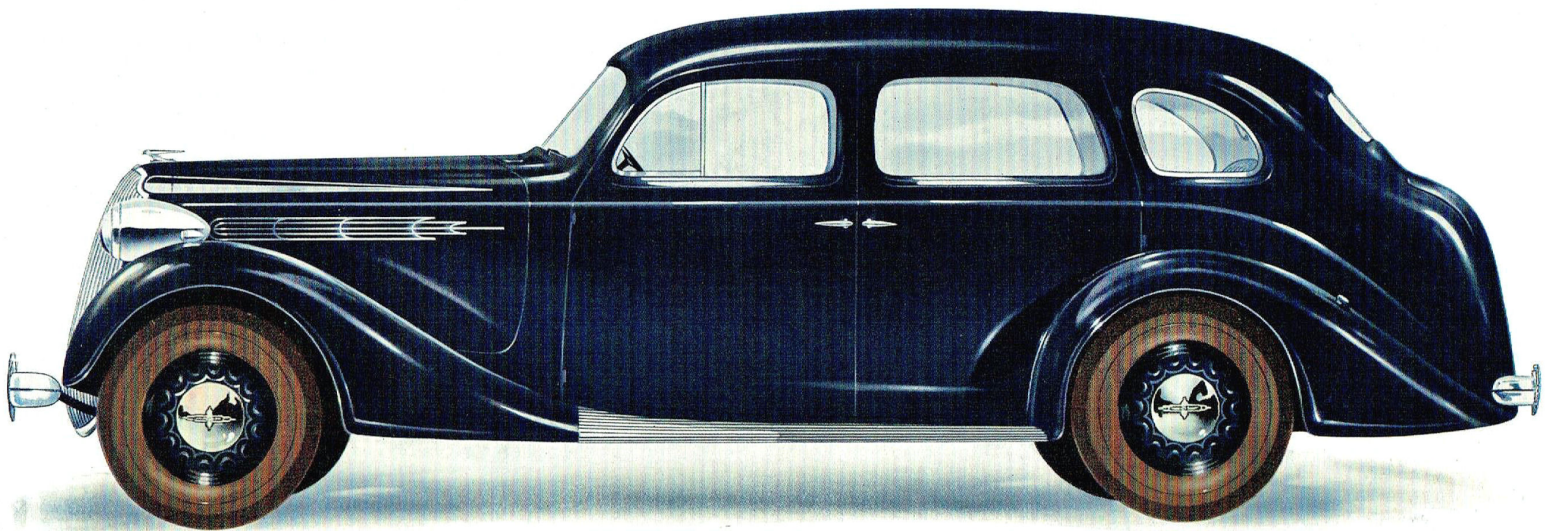

FOR those whose position or requirements call for a 7-passenger Saloon, Vauxhall provides a sumptuous model on a wheelbase of 130 inches at a price that is literally amazing to those accustomed to the cost of English cars of its dimensions. Vauxhall 7-passenger Saloon is indeed priced at just a few pounds more than the figure at which it is available in Piccadilly's motor showrooms. The reason is that not only has the natural price increase over the English cost of the Vauxhall 7-passenger Saloon been kept to a minimum, but Vauxhall's association with Holden's allows of economies that would not be possible in the case of the importation of the entire car. With Holden's to interpret faithfully English good taste in body work, Vauxhall can thus present a 7-passenger Saloon at a figure which comparison will prove to you is unparalleled in the fine English car field in Australia.

A CAR PROPORTIONED FOR THOSE WHO LIKE SPACIOUSNESS

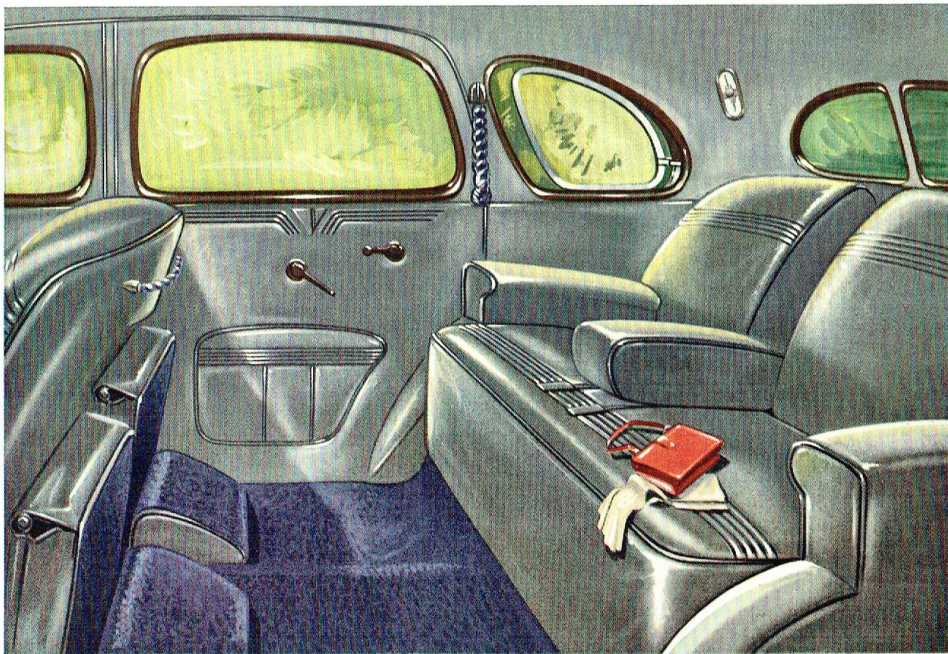

AN INTERIOR THAT IS QUIET, EVEN AT HIGH SPEEDS OR AMID THE ROAR OF THE CITY.

The blare of horns, the clanging of trams, all the roar of the city around reaches only faintly the ears of passengers in the Vauxhall 7-passenger Saloon. Inside that scientifically sound-proof Unisteel Body with its gleaming "Turret" Top, all is quiet and serene. You may carry on your conversation in the same modulated voice that you use in the seclusion of your own home. How great a contribution to more luxurious motoring has been made by Holden Body Engineers you can only appreciate by actually riding in the Vauxhall 7-passenger Saloon.

THE Vauxhall 7-passenger Saloon is dimensioned for those who live leisurely. Note the distance between the driver's and the rear seat . . . the width of the arm rests . . . the breadth of the luxurious, soft-leather Relax-o-form Seats . . . the space in the rear even with the occasional seats in place. Here is a car that can accommodate 5 in luxury . . . 7 in comfort . . . without a crease in a frock. Wide doors give complete freedom of entry and exit.

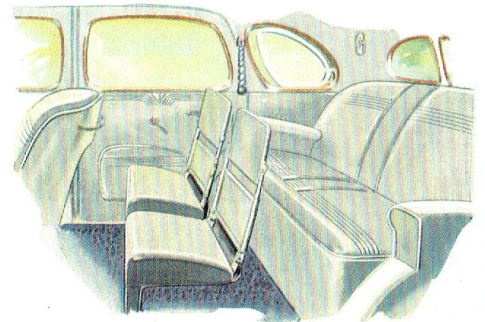

SPECIFICATIONS

Two different chassis models are available on the Vauxhall "25." The STANDARD chassis (9 ft. 3 in. wheelbase). The LONG chassis (10 ft. 10 in. wheelbase).

ENGINE. Six cylinder overhead valve type. Detachable cylinder head. Four bearing crankshaft fitted with vibration damper. Engine rubber-mounted in frame at five points. Bore and stroke, 81.94 x 101.6 mm. Displacement, 3,125 c.c. Rating, 24.97 h.p. Special "non-pinking" combustion chamber design. Compression Ratio, 6 to 1. Brake Horse Power, 80 at 3,600 r.p.m.

ENGINE LUBRICATION. High pressure automatic force feed system from submerged gear pump to main, big end, connecting rod and camshaft bearings, cylinder walls and overhead valve gear. Connecting rods drilled to force lubricate small end bearings. Crankcase ventilation. Oil filters.

CARBURETTOR. Zenith down-draught with accelerating pump and inter-connected choke and throttle controls, for easy starting. Air intake fitted with air cleaner. Complete and rapid vaporisation is ensured by thermostatically controlled exhaust heating of induction manifold.

FUEL SUPPLY. Petrol pump driven from crankshaft. Twelve gallon tank at rear of chassis.

COOLING. Thermostatically controlled circulation. Impeller pump with four-bladed fan. Cylinders water-jacketed to bottom of barrels. Sparking plug bosses and exhaust valves specially cooled by directed water spray.

STARTER. Pedomatic type which automatically starts the engine when the clutch pedal is depressed.

IGNITION. Lucas 12-volt coil and distributor. Fully automatic advance and retard by centrifugal governor and by vacuum control from the induction. Micrometer adjustment for regulating ignition to suit grade of fuel.

ELECTRICAL SYSTEM. 12-volt. Lucas three-rate dynamo charging 12-volt 88 ampere hour battery. Fuse box on dash, fitted with five independent fuses and six

spare fuses. Foot operated head lamp dipping switch which dips nearside lamp and extinguishes off-side. Combined stop, tail and reversing lamp.

CLUTCH. Single dry plate type with flexible centre for smooth engagement. Designed to utilise centrifugal force increasing spring pressure at high engine revs. and giving light pedal pressure at low speeds.

GEARBOX. Four-speed forward and reverse. Super synchromesh easy gear change mechanism, with helical gears giving silent third. Accessible dipstick and oil filler orifice.

UNIVERSAL JOINTS. Two, of Hardy-Spicer needle bearing type. Tubular propeller shaft.

REAR AXLE. Semi-floating, spiral bevel type. Rubber mounted to springs.

FINAL DRIVE RATIOS. Top, 4.44 to 1. 3rd, 6.7 to 1. 2nd, 9.9 to 1. 1st, 14.2 to 1. Reverse, 16.4 to 1.

FRAME. Cruciform (x) type having great rigidity. Five cross members.

STEERING. Marles cam and roller type. Ratio, 15.5 to 1. Steering wheel, 17½" diameter. Turning circle, 41' 5" left, 43' right.

SUSPENSION. Front—Independent front wheel springing of the torsion bar type, operating in totally enclosed oil bath. Progressive spring action increases resistance of springing on bad surfaces and prevents rolling on corners. Double-acting hydraulic shock absorbers included in construction.

Rear—Semi-elliptic underslung rear springs 54½" long. Silentbloc bush at front end. Single-acting hydraulic shock absorbers with inter-controlled operation.

BRAKES. Lockheed hydraulic on all four wheels, operated by foot pedal. Double safety type, front and rear brakes acting independently if pipe line is fractured.

Central cable-operated handbrake lever operates rear shoes only. Cast iron drums.

WHEELS. Large hub, easy-clean wheels. Tyres: Standard chassis, 6.25" x 16". Long wheelbase chassis, 6.50" x 16". Spare wheel carried in separate compartment at rear.

CHASSIS LUBRICATION. By oil gun from accessibly grouped nipples.

EASY JACKING SYSTEM. Jacking operation made easy by provision of ball-bearing, brace-operated jack which fits into accessible brackets designed for this purpose.

EQUIPMENT. Armourplate Safety Glass in windscreen and all side windows. Bumpers front and rear. Tool kit. Roomy Inbuilt Luggage Trunk. Separate Spare Tyre Compartment. Improved No-Draught Ventilation. New-type Adjustable Driver's Seat. Adjustable Steering Wheel. Electric Windscreen Wipers (Dual). Iridescent Tenite Interior Handles. Relax-o-form Seats. Glove Box. Provision for Radio. Two-Way Sun Visors (2). Visor Vanity Mirror. Corded Silk Rug Strap. Carpeted Footrest. New, tasteful treatment of upholstery. Large Cowl Ventilator with insect screen. Armrests in both front and rear. Pockets in all Doors.

INSTRUMENT PANEL. Indirectly lighted and fitted with speedometer, 8-day clock, electric petrol gauge, ammeter, electrically operated oil warning light, ignition warning light, mixture control, engine switch and charging and lighting switch.

DIMENSIONS

Wheelbase	9' 3"	10' 10"
Track, front	57¼"	57¼"
rear	57¼"	57¼"
Ground clearance	7½"	7½"
Overall width	5' 11¼"	5' 11¼"

The right is reserved to alter any details of price, specification, or equipment without notice

G.M.A.C. CONFIDENTIAL PAYMENT PLAN

When you acquire your Vauxhall under the G.M.A.C. Confidential Payment Plan you enter into business relations, not with an outside finance organization, but with a Company which is a unit of General Motors and thus has a direct interest in maintaining your satisfaction. Because General Motors Acceptance Corporation is the largest Hire Purchase Institution in the world, it is able to offer low rental charges and to arrange a payment Plan fitted to your individual requirements. Your local dealer can explain the G.M.A.C. Plan to you and arrange your payments on a basis convenient to you.

SERVICE

You are protected in two ways when you choose a Vauxhall. 1. By General Motors-Holden's Owner Service Policy which protects you for ninety days or 3,000 miles of operation against defective workmanship or material, during which time you are entitled to two thorough inspections and adjustments without charge. 2. By Vauxhall's widespread service and spare parts facilities . . . easily the most extensive of any English car in Australia.

G E N E R A L M O T O R S — H O L D E N ' S L I M I T E D

2822

BRISBANE

SYDNEY

MELBOURNE

ADELAIDE

PERTH

Printed in Australia.

