

VAUXHALL 'FOURTEEN'

The Happy Medium VAUXHALL '14'

Blends big car comfort and performance with small car economy

SINCE 1933 the Vauxhall '14' has been an outstandingly successful car in Australia. Over 14,000 motorists have found in this car a combination of characteristics that most nearly fits their conception of the ideal car.

For it was designed to suit the big majority of motorists. It's **not too big**—yet big enough to give spirited performance and (with its longer, wider body on the lengthened wheelbase of 105") to seat 5 or 6 in superb comfort. It's **not too small**—yet small enough to combine low purchase price with an economy of over 30 m.p.g. (actual figures in one test were 30.31 m.p.g. over the English R.A.C. 1,000-mile course, including much of London's thickest traffic).

Because it was the first car to combine successfully the advantages of both the big car and the small car, the Vauxhall '14' immediately became a great favourite. The first model appeared in 1933 and orders for the new '14' were months behind. Sales figures soared . . . Vauxhall quickly became the fourth best seller in Australia . . . then third best . . . a degree of acceptance by the Australian public never before so quickly achieved.

Now, in this new model the Vauxhall '14' presents the most feature-full English car you've ever seen at such a low price. It has a new, lovelier appearance, new radiator (still embodying the traditional fluted design) new all steel Turret Top Body, by Holden, with its many luxuries of finish and equipment. It has a more powerful engine that's full of

zestful performance yet still gives the amazing economy of over 30 m.p.g. It has Lockheed Hydraulic Brakes—giving a greater sense of security than before. It has Vauxhall's patented T.T. Independent Springing which adapts itself—'soft' or 'hard'—to every type of road surface. It has a synchro-mesh 3-speed gear box which, combined with the new 'Safety Vision' (larger windscreen and side windows of Armour-plate Safety Glass) creates a new ease of control specially appreciated by women drivers. It gives you everything in features, luxurious furnishing and craftsmanlike finish—far beyond what you would expect in such a low-priced car.

But low price and the extra miles-per-gallon are by no means the whole story of Vauxhall '14's' economy. For it can be definitely said that this car has the best resale value (in proportion to cost price) of any car in Australia. Indeed, as a check of used car prices will show, a two-year-old Vauxhall '14' sells for about as much as many cars originally costing £100 more!

The new Vauxhall '14' is front page news in motordom. It's the most **exciting** car in Australia today for it does more than any other to give you the motoring ideal—big car comfort and performance with small car economy.

Before you make any final decision do yourself the justice of experiencing just how good the '14' is in actual practice. We believe it will delight you, and that it offers more than you ever expected for such a moderate cost.



This is probably the first convertible coupe to be offered in Australia as a standard model on a medium priced car. This body style combines the advantages of closed car comfort and open car freedom. In creating this Convertible Coupe, Holden's have paid especial attention to beauty of line, and with hood up or down the Vauxhall is a dashing sports car. Main points of interest are the V windscreen, easy folding and raising of hood, narrow pillars fitted with no-draught ventilation panes, 3-seater comfort, winding windows and an ample rumble seat.

Vauxhall "14"

CONVERTIBLE
COUPE

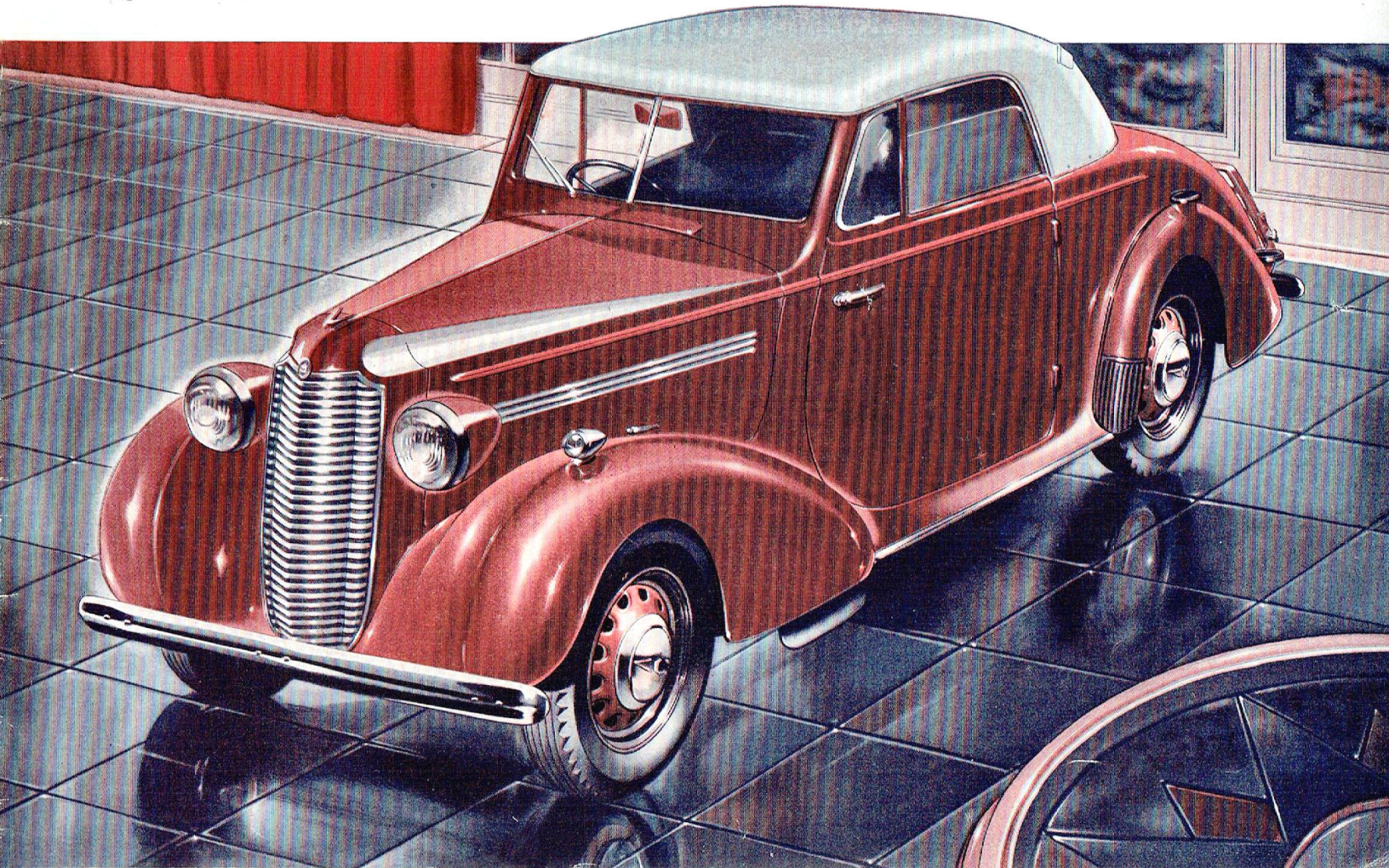

A HOLDEN-BUILT

Behind the smart appearance and rich finish of the new Holden-built Vauxhall '14' bodies are three important factors: plant, men and experience. The Holden plant and equipment are the finest in the Southern Hemisphere . . . the men are Australia's most skilled body engineers and craftsmen . . . and the experience of Holden extends over 22 years in making bodies to suit Australian conditions.

Let's examine these points in more detail with relation to the Holden Vauxhall '14' Saloon Body. First sit in the front seat and observe how the engineers have built a body that is easy to see out of! We call it 'Safety Vision' because with the narrow pillars (made possible with box section engineering of the all steel body) the driver has a clear all-round vision. 'Safety Vision' with its elimination of blind spots gives a sense of greater control—it means easier handling, more confident

● *At Left: An impression of the huge 1,000 ton Hamilton Press used in the manufacture of the Vauxhall '14' Body by Holden. This Press is the most powerful of its type and is the only one in the British Empire.*



BOX SECTION BODY—Body girders are four-sided giving added strength and permitting narrower pillars and modern 'Safety Vision.'



'SAFETY VISION'—There's greater glass area in the new Vauxhall '14' (greater than some bigger cars) adding to ease of control.



NO-DRAUGHT VENTILATION—With a touch you control the ventilating panes admitting fresh air to the car without draughts.

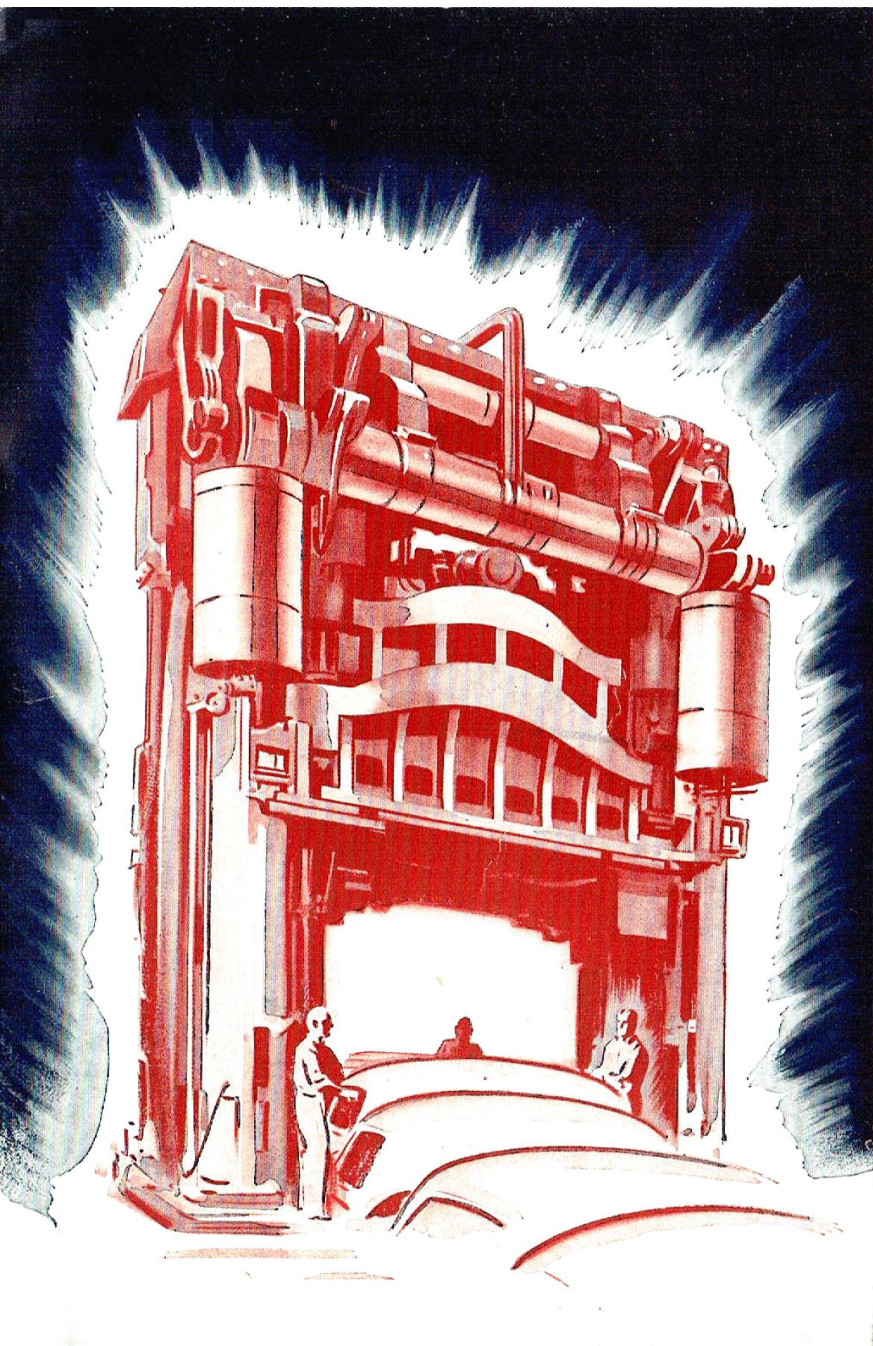

BODY IS THE BEST MONEY CAN BUY

parking, and simplified manoeuvring on every occasion, especially noticeable when you drive over a rough track and steer to miss the deepest ruts and biggest bumps. Then there's the All Steel Turret Top Body—a body that has not one screw or rivet in its entire construction. Top, sides and floor are stamped out in large sections in the most modern presses and electrically welded together to make a solid, one-piece body of immense strength, giving a new measure of safety.

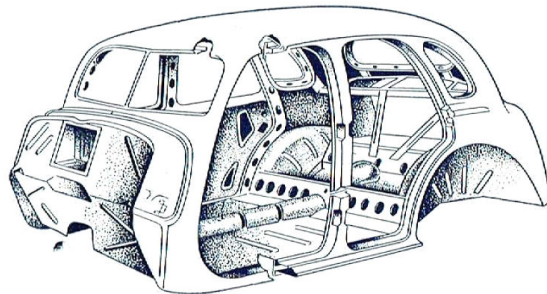

Top: The All Steel Turret Top Body of the Vauxhall '14' is of box section construction for greater strength. Top, floor and sides are welded together (no screws, bolts or rivets used) to form a safe structure of solid steel.

'This body, too, must withstand every extreme of heat and cold' . . . insisted the Holden Body engineers. So with scientific insulation of the entire interior the Vauxhall '14' is more comfortable in all weathers and in all climates, whilst it is draught and dust sealed around all doors and window openings. And, in keeping with Holden's policy to provide every comfort of even the most expensive cars, these

features are built into the Vauxhall '14' bodies: No-Draught Ventilation, Multi-adjustable Front Seat, Armourplate Safety Glass Windscreen and Side Windows, Relax-o-form Seat Springing and a roomy luggage trunk.

The following list of measurements shows the ample roominess of this modern body—a roominess which ensures a restful trip even on the longest journey:

Front Compartment		Back Compartment	
Leg Room - - - -	39"	Leg Room - - - -	38"
Head Room - - - -	36"	Head Room - - - -	35"
Shoulder Room - - -	49"	Shoulder Room - - -	53"

Actually the rear leg-room is greater than shown by these measurements, for the feet can be stretched out at full length under the front seat. With such roominess embodied in its long, low lines, the Vauxhall '14' is more than ever a family-sized car of luxurious comfort for both front and rear-seat passengers.

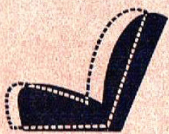

MULTI-ADJUSTABLE FRONT SEAT—Everyone can drive in comfort—the seat moves up and down as well as forward and backward.



ARMOURPLATE SAFETY GLASS—If a tremendous impact did break the glass it would fall to the floor in small rounded pebbles.



INSULATION—Scientific body insulation protects you from variations in temperature in both summer and winter and absorbs noise.



RELAX-O-FORM SEATING—Cradling spring seats hug the body and make even the longest trip restful and comfortable for all passengers.



ROOMY LUGGAGE TRUNK—Here's a real luggage space, with separate storage of the spare which is available without disturbing luggage.



EASY JACKING SYSTEM—No scrambling around on hands and knees—the car can be jacked up comfortably with a new Vauxhall jack.

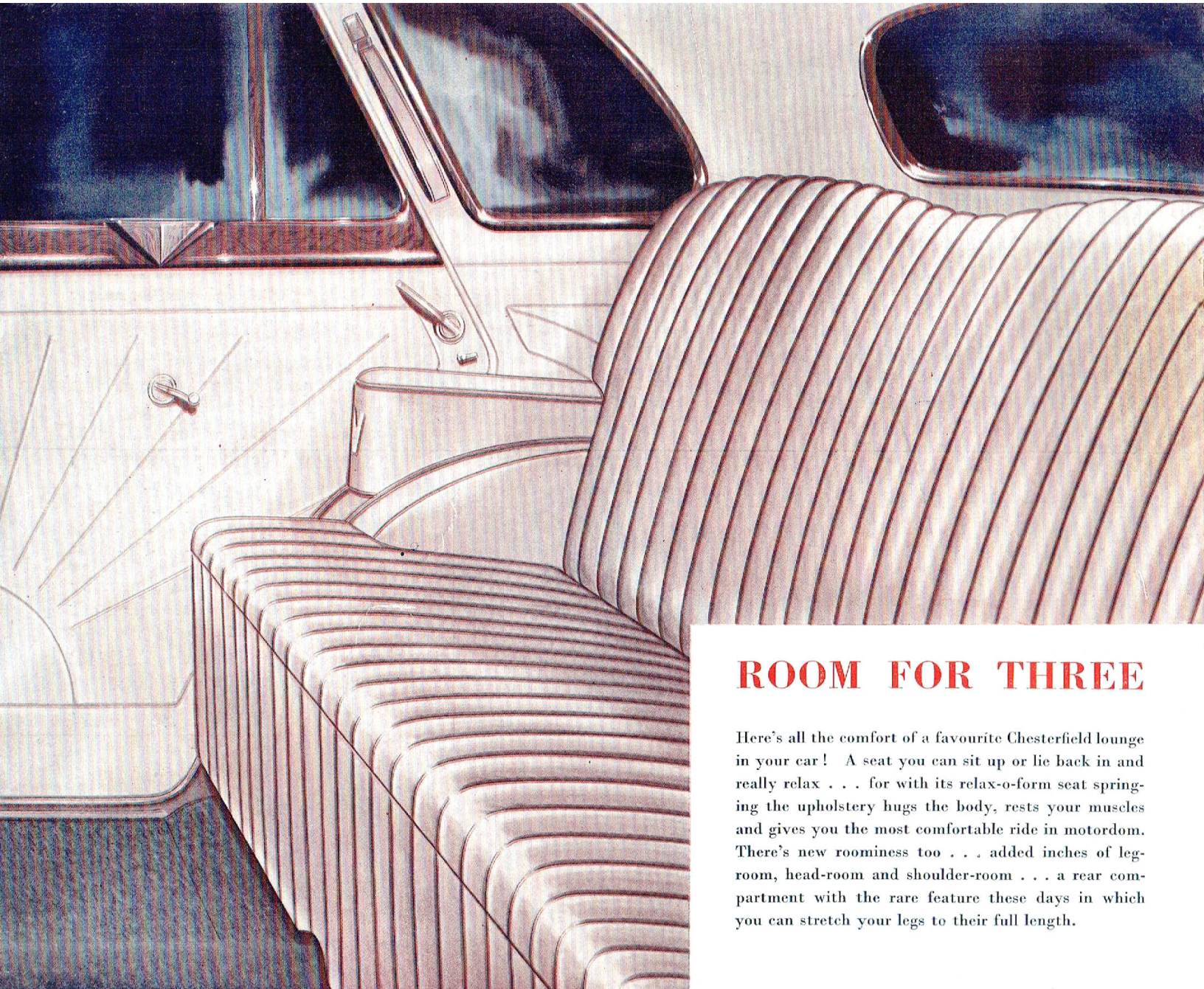

ROOM FOR THREE

Here's all the comfort of a favourite Chesterfield lounge in your car! A seat you can sit up or lie back in and really relax . . . for with its relax-o-form seat springing the upholstery hugs the body, rests your muscles and gives you the most comfortable ride in motordom. There's new roominess too . . . added inches of leg-room, head-room and shoulder-room . . . a rear compartment with the rare feature these days in which you can stretch your legs to their full length.



Vauxhall "14"
SALON

Here is the ideal 'Happy Medium' closed car. Big car performance, big car looks, big car comfort, yet a money saver on petrol giving you half as many more miles to the gallon as most other 5-6 seaters. If you've owned a big car this fourteen will appeal to you because of its roominess. If on the other hand your preference has been for smaller saloons you'll be mighty glad of the Vauxhall's more powerful engine which has registered over 30 m.p.g. in recent Automobile Club tests.

Vauxhall "14"

SPORTS
ROADSTER

Look at it—a Sports Roadster that will gladden your heart! Built on big car lines with a roomy front compartment and a comfortable rumble seat. If you like the freedom of an open car—here's the model that answers your every wish.

Travellers! Business Houses! This model is also available as a Business Roadster with a top-hinged rear door opening into the giant-sized boot.

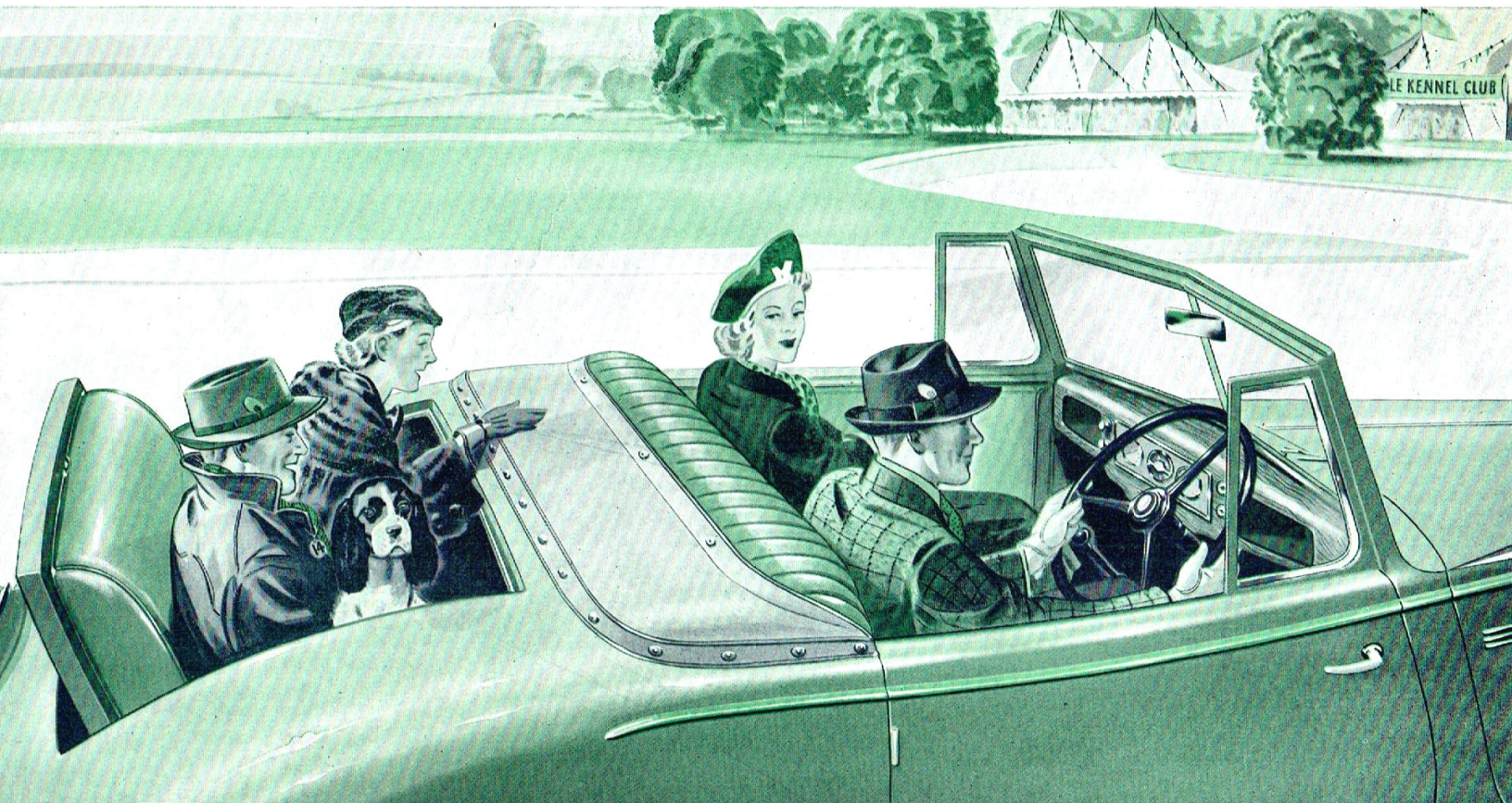
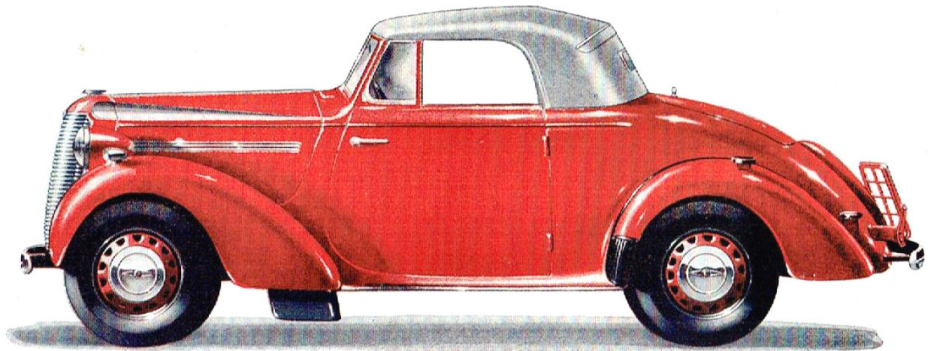

VAUXHALL '14' IS ENGINEERED FOR COMFORT AND SAFETY

'T.T.' INDEPENDENT SPRINGING—No other car but Vauxhall has the patented Vauxhall 'T.T.' Independent Front Wheel Springing. It is the most modern type of springing yet evolved, for it automatically regulates itself to give 'soft' or 'hard' springing to suit every type of road. The photograph at right makes it look complicated—yet its operation is extremely simple. The cut-away diagram illustrated at left shows how the infinitely variable suspension works. The wheel is fixed on the wheel carrier arm (A). When this arm rises or falls with the movements of the wheels, it twists the torsion bar and tube (C and B)—and takes the maximum shocks. On good roads, the coil spring (D) bearing upon the toggle (E) helps the wheel to twist the bar and tube. It will be realised that the full effect of this spring is felt while the wheel movements are relatively slight. When bad surfaces have to be negotiated, the toggle moves further away from dead centre, and the power exerted by the spring (and therefore the assistance it can render) becomes progressively less, thus stiffening the suspension. The springing is damped under all conditions by the double-acting shock absorber (F).

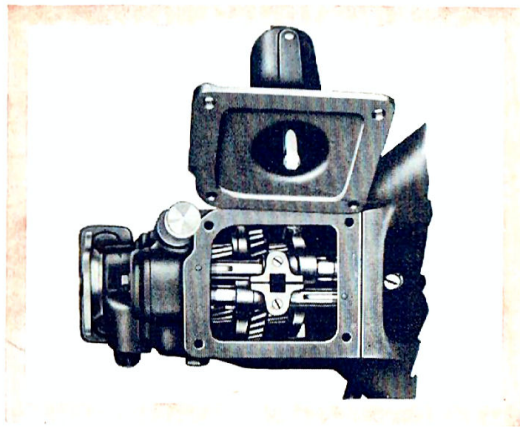
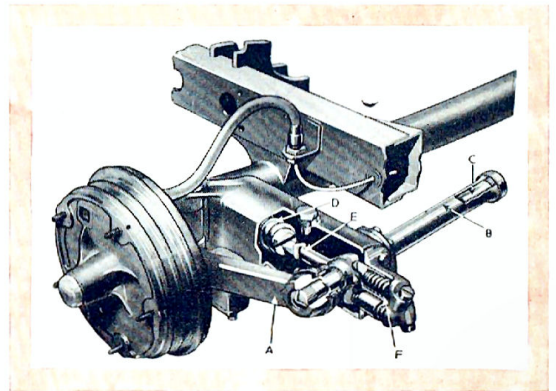

3-SPEED SYNCHRO-MESH GEAR BOX

The new 3-speed gear box is one of this car's most attractive features, particularly for women drivers, making it easier to handle and giving greater control. All gears are helically cut for silent operation, and changing from top to second or from second to top can be achieved at any speed without clashing. Don't make the mistake in thinking that all synchro-mesh gear boxes are equally good. Vauxhall's synchro-mesh is immeasurably superior and does make faultless gear changing supremely easy even for the novice.

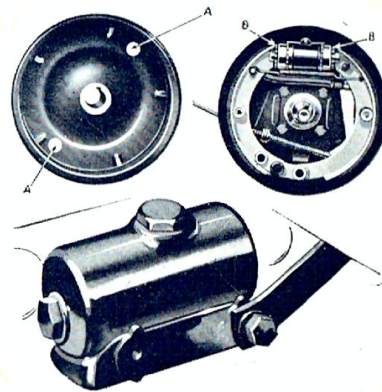

LOCKHEED HYDRAULIC BRAKES

The brake pedal of the Vauxhall '14' operates on the master cylinder shown at left, and immediately you have a tremendous braking pressure transmitted to all four wheels. Braking is automatically equalised on all drums, and pedal pressure has been considerably reduced. Each brake drum is furnished with two screws, and to 'take up' the brakes all you need to do is to adjust the screws. The circular photographs at left show the extreme simplicity

of adjustment. The two openings (A) in the brake drum give access to the notched adjusters (B), which merely have to be turned with a screwdriver or similar tool until the wheel binds, and then slackened back four notches. The hand brake lever is conveniently placed underneath the instrument panel and operates rear brake shoes only.

SUMMARY OF ALL MAIN FEATURES OF THE VAUXHALL FOURTEEN

ENGINE

Six-cylinders overhead valves . . . Increased B.H.P. 48 at 3,800 . . . 6-Phase carburettor . . . Controlled Flame Combustion . . . 3-Speed controlled synchro-mesh gear box . . . Z-slot rubber engine mountings . . . Full pressure lubrication . . . 100 per cent. counter-weighted crankshaft . . . Diagonally divided big end bearings . . . Oval ground pistons . . . Full length water jackets . . . Trap door thermostat . . . Thermostatic cooling control . . . Two oil cleaners . . . Compensated voltage dynamo . . . Automatic advance and retard of ignition . . . Octane Selector . . . Individual fuse system.

CHASSIS

Longer wheelbase—105" . . . Re-designed rear axle . . . T.T. Independent Springing . . . Lockheed Hydraulic Brakes . . . Screw brake adjusters in drums . . . Cushioned clutch . . . Shockless Burman-Douglas steering . . . Smart easy-to-clean wheels . . . Easy maintenance—only 13 grease nipples . . . Battery under bonnet.

BODY

All Steel Turret Top . . . 'Safety Vision' . . . Narrower pillars . . . Increased glass area . . . Box section body construction . . . Increased roominess . . . V windshield . . . Adjustable Steering Wheel . . . More roomy luggage trunk . . . No-Draught Ventilation . . . Attractive Tenite Interior Hardware . . . Multi-adjustable Front Seat . . . Relax-o-form Seat Springing . . . Armourplate Safety Glass . . . Genuine leather upholstery . . . Easy jacking system . . . Sound insulation . . . Draught and Dust Seals.

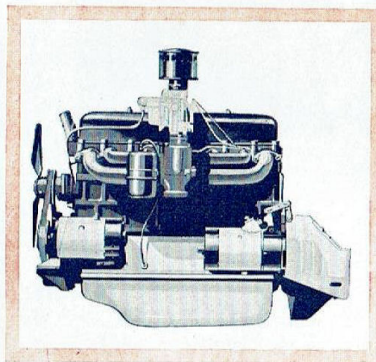

50% MORE MILES MOST OTHER

THE 14 H.P. ENGINE

The overhead valve design (which is 10 per cent. more efficient than other types) has been retained in the improved Vauxhall '14' engine, but power has been boosted to 48 brake horsepower. Result: swifter acceleration, better top gear performance, never a suggestion of labouring even with a full load on board. There's no 'fussiness' either, for the engine is smoother and 'sweeter' at all speeds.

CONTROLLED FLAME COMBUSTION

See the new shape of the piston? Not flat on top as it has been in cars since the first 'one-lunger'—but slightly curved.

And see, too, where the valves are—the exhaust valve being located at a higher level than the inlet valve. This placing of the valves helps to make the combustion chamber more compact and, combined with the new piston design, controls the spread of the flame from the spark plug. The pressure increases gradually and 'pushes' the piston down on its power stroke, thus giving smooth running and obviating the 'hammer blows' which are the main cause of rough running. The Vauxhall 14's 'controlled flame' design is one of the reasons for the car's amazing economy.

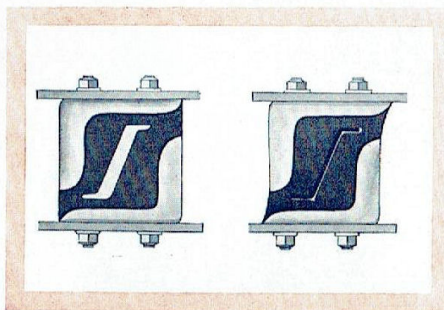
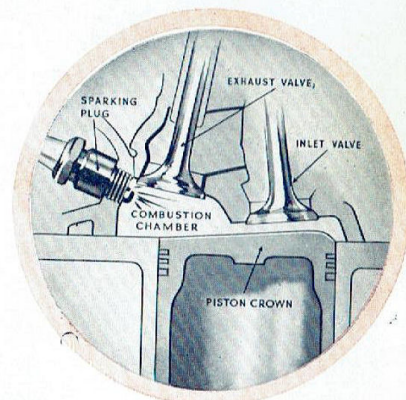

Z-SLOT ENGINE MOUNTINGS

These two illustrations show how the special Vauxhall Z-slot engine mountings operate. Normally the slots are open when the engine is idling or vibrating slightly, giving a fairly flexible mounting. But as soon as the vibration is increased, the slots close, making what is virtually a solid rubber cushion which smothers engine movement and vibration.



ADJUSTABLE STEERING WHEEL

No car manufacturer can build a fixed steering column and be sure it will suit everybody. Vauxhall have incorporated an adjustable steering column—the wheel can be raised or lowered to suit every driver.

PER GALLON THAN 5-6 SEATERS

SIX-PHASE CARBURETTOR

One reason for Vauxhall's better performance and greater economy is the Six-phase carburettor. Ordinarily a carburettor has only three mixtures: One for starting, one for idling and one for general running. Vauxhall has 6 mixtures instead of 3. It has the first two (for starting and idling) but has four for general running. The carburettor switches automatically from one mixture to the other just as the engine requires it. If you accelerate suddenly on part or full throttle—more petrol is pumped in. If you are running easily on part or full throttle—more air is admitted, thereby weakening the mixture and saving petrol.

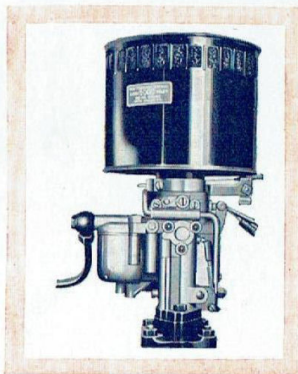

TRAPDOOR THERMOSTAT

Vauxhall is one car which makes sure that the engine is ready for anything within half a mile of starting (even on the coldest days) by specially preheating the mixture before it enters the combustion chamber. Upon starting from 'cold' the flap 'B' is in such a position that hot exhaust gases 'DD' are deflected behind and over the inlet manifold 'E,' thus preheating the mixture. As the engine warms up, the spring 'A' automatically allows the weight 'C' to alter the position of the flap so that the exhaust gases escape direct without surrounding the inlet manifold.

As soon as the engine cools down during a stop, the spring contracts and returns the flap to the 'cold' position.

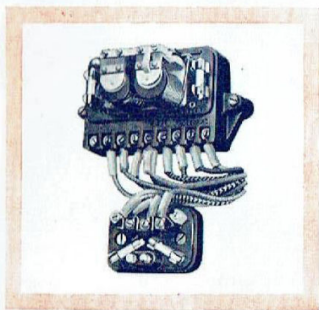
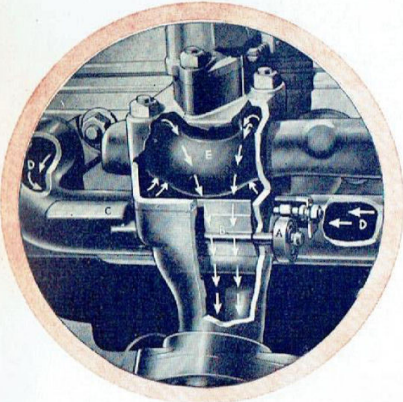

FUSE BOX

You never have a complete 'black out' of lights in a Vauxhall. The four-way fuse box controls four separate electrical circuits each with its own fuse. A voltage control ensures that the battery is never overcharged even when the car is used only for daylight running.

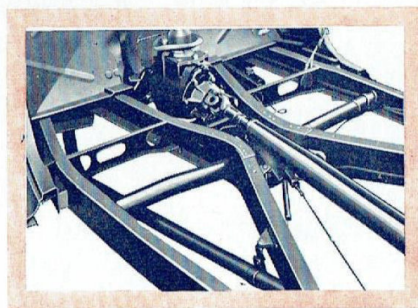

FRAME

What a husky frame! Look at the deep side members, the X-shaped girders and the stout cross member. No chance here for 'weaving' or straining even on daily runs over the roughest of country roads. This 'big car' chassis is one of the outstanding reasons for the long, trouble-free life of the Vauxhall '14.'

Accessories

to personalise your Vauxhall '14'

'AIR CHIEF' CAR RADIO

Add to your enjoyment of your Vauxhall '14' (and incidentally heighten its value) with an 'Air Chief' Car Radio. On long trips or short trips, on week-end jaunts or going about your week-day business, you will find 'Air Chief' a happy companion that will keep you in high spirits. The quality radio of its field, 'Air Chief' has controls to harmonise with Vauxhall '14's' handsome instrument panel. 'Air Chief' is Australia's most perfect car radio—a six valve superheterodyne set having three double-purpose valves, giving it 9-valve performance. You have a choice of speakers—either over the windshield or under the dash. Ask your Dealer to demonstrate to you the rich tone and clarity of reproduction of 'Air Chief' Car Radio. Remember if you are buying your Vauxhall '14' on terms you can include the cost of an 'Air Chief' Car Radio in your monthly payments.

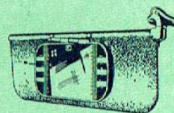
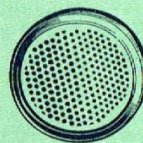
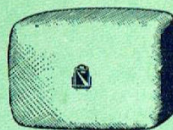

VISOR VANITY MIRROR

The Vanity Mirror, shown in the illustration, clips to the interior sun visor. This mirror has six ground glass spaces at the sides on which you can conveniently note data such as oil change, mileage, etc.

DE LUXE GEAR LEVER KNOB

The handsome De Luxe Gear Lever Knob imparts a new touch of beauty to the interior and is a low-priced accessory that gives a real individuality to the car.



DUCO CLEANER AND POLISH

If you are an owner who takes a pride in keeping your car spick-and-span, you will see more result for your effort if you use Nasco Duco Cleaner and Polish. This preparation does the twofold job of removing the dull coating of traffic film and then imparting a brilliant, lustrous polish.



RADIATOR RUST PREVENTATIVE

Nasco Radiator Rust Preventative is a compound which has already been added to the cooling system of your Vauxhall when you take delivery. It keeps the radiator clean, ensures efficient cooling and needs replacement only after the radiator is drained.

OTHER ACCESSORIES INCLUDE .

Kool Kooshion, Dual Matched Horns, Nasco Tyre Gauge, Inspection Lamp, Door ease, Tandem Windshield Wiper Unit, Nasco Leather Cleaner and Polish, Nasco Chromium Cleaner and Polish, and Lefthand Sun Visor.

Condensed Specifications of the 'Happy Medium' VAUXHALL '14'

ENGINE: Six cylinder with overhead valves, cylinders are cast integrally with upper half of crankcase. Detachable cylinder head of high compression non-detonating type. Power unit mounted in the frame with special Z-slot rubber insulators.

Bore 2.42"—Stroke 3.94"—R.A.C. rating 14.07 horsepower. Brake horsepower 48 at 3,800 r.p.m.

COMPRESSION RATIO: 6.75 to 1.

CRANKSHAFT: Four bearing, high tensile steel drop-forged crankshaft. Statically and dynamically balanced. Main bearings steel backed lined white metal.

PISTONS: Aluminium alloy oval ground split skirt type. Three rings all above gudgeon pin. Two compression rings. Lower ring oil regulating type, seated in groove designed for oil return.

CAMSHAFT: Drop-forged, heat-treated carbon steel with four bearings.

OILING SYSTEM: High-pressure system. Oil is fed through a short copper pipe to a main gallery drilled lengthwise through the crankcase. Crosswise passages carry oil from gallery to main bearings from which it passes through grooves and drilled holes to the camshaft bearings. Crank pins are lubricated through holes drilled in the crankshaft. Oil jets from big ends lubricate cylinder bores, piston pins, etc.

CRANKCASE VENTILATOR: Air is drawn in through breather on oil filler plug situated on top of the rocker gear cover and is ejected together with vapour and fumes through a ventilator pipe attached to the right-hand side of engine at front end of the crankcase. The pipe protrudes below the undershield, thereby preventing fumes from entering the interior of the body.

CARBURETTOR: Vauxhall Six Mixture incorporating acceleration pump, automatic part throttle economy device, inter-connected strangler and throttle control. Especially designed choke shutter ensures easy starting from cold without excessive richness. Combined AC air filter, silencer and flame arrester mounted on air intake.

FUEL SUPPLY: AC fuel pump; 10-gallon tank at rear. Electric type fuel indicator on instrument panel.

IGNITION: Separate unit type.

TRANSMISSION: Three-speed type with synchro-mesh easy change mechanism using helical gears for quiet operation. Three speeds forward, one reverse. Transmission ratios—

Top	-	Direct	First	-	3.43 to 1
Second	-	1.64 to 1	Reverse	-	3.56 to 1

WHEELBASE: 105 inches.

CLUTCH: Single dry plate, 8" diameter.

COOLING: Circulation is by centrifugal pump located at the front end of engine. Circulation between the cylinder block and cylinder head jackets is by means of cored slots and nozzles fitted to the base of the cylinder head. In this way jets of water are directed around exhaust valve seats and sparking plug bosses. The circulation is controlled by a thermostat valve mounted on water outlet casting at front end of cylinder head.

REAR AXLE: Semi-floating type with one piece pressed steel banjo type housing; insulated from rear springs by rubber pads. Gear ratios—

Top	Second	First	Reverse
4.71	7.72	16.15	16.77

SERVICE BRAKES: Lockheed hydraulic system, operated by pedal and acting upon all four wheels—9½-in. drum diameter. Front and rear brake shoes are interchangeable in sets.

HAND BRAKE: Pivoted in inverted position under scuttle on R.H. side. Hand lever operates rear brake shoes.

WHEELS: Ventilated steel disc wheels (14-spoke) with large hubs fitted with spring-retained covers.

TYRES: 5.50-in. x 16-in.

STEERING GEAR: Burman-Douglas screw and nut type with self-centring action, 17" steering wheel. Column adjustable for length.

TURNING CIRCLE: Left or Right—42-ft. diameter.

REAR SPRINGS: Semi-elliptic of special spring steel,

underslung, fitted with Silentbushes at both ends. Centre distance: spring brackets, 45"; width, 1½".

INDEPENDENT FRONT WHEEL SPRINGING: Vauxhall's patented 'T.T.' Independent Front Wheel Springing is infinitely variable to give springing tension suitable for every type of road. Shock absorbers are of double hydraulic acting type, being incorporated in the general construction. Rear shock absorbers, Lovejoy type, single acting units.

SPECIAL JACKING SYSTEM: High-lift hydraulic screw jack operated by wheel-bolt brace and used by attaching to suitable brackets on rear springs and pads on front suspension units.

FRAME: Cruciform 'X' type having extreme torsional rigidity. The front quarter length is of box section formed by the channel section of each side member, and by the Cruciform member.

EQUIPMENT: All cars equipped with high pressure fittings for manual lubrication. Instrument panel (indirectly lighted) includes speedometer and eight-day clock; oil pressure and ignition warning lights; petrol gauge and ammeter; combined charging and lighting switch; ignition switch with two keys; mixture control for starting; starter control; panel light switch and cubby holes on right and left of dash. Provision for radio control installation on right hand side. Foot-operated head-light dimmer switch on toe board; inside sun visor on Saloon. Rear vision mirror. Full bumpers at front and rear. Ashtray in instrument panel. Combination stop and tail lamp. Interior roof lamp on Saloon. Complete tool kit in spare wheel compartment. Multi-adjustable front seat on Saloon. Armourplate Safety Glass Windscreen and side windows and no-draught ventilation, cowl ventilator, windscreen wiper and 4-way fuse box with two spare fuses are also included as standard equipment. Luggage rack at rear on the Sports Roadster and Coupe, built-in luggage trunk on Saloon. Spare wheel with metal cover on Coupe and Sports Roadster, semi-flush mounted in lower back panel. On Saloon this is carried in locker beneath luggage compartment at rear.

Prices, specifications and equipment subject to change without notice.

G.M.A.C. CONFIDENTIAL PURCHASE PLAN

Under the flexible G.M.A.C. Plan you can buy your Vauxhall on terms to exactly suit your requirements. Because G.M.A.C. (General Motors' Acceptance Corporation) is a unit of General Motors and the largest terms financing institution in the world, you save money through low finance charges, and are assured of considerate treatment. Your dealer will tell you how easy a Vauxhall is to own.

AN UNUSUAL OWNER SERVICE POLICY

For 90 days, or 3,000 miles of operation, you are protected against defective workmanship or material under the terms of General Motors-Holden's Ltd. unusual Owner Service Policy. In addition to this, you are entitled to two thorough inspections and adjustments without charge. There are throughout Australia hundreds of specialised Vauxhall dealers with properly trained and equipped mechanics . . . conversant with Vauxhall.

GENERAL MOTORS - HOLDEN'S LIMITED

BRISBANE - - - SYDNEY - - - MELBOURNE - - - ADELAIDE - - - PERTH

Distributors for Qland & Northern Rivers N. S. W.

E. G. Eager & Son Ltd.

Breakfast Creek Road,
Newstead, Brisbane

PRINTED IN AUSTRALIA.