



Commercial
Vehicles

The Caddy



Gets through anything. The Caddy.

Through narrow streets, heavy traffic, and the most arduous working day. It is as manoeuvrable as a passenger car yet offers as much space as a true commercial vehicle. This makes the Caddy very versatile in town traffic. Above all, it offers everything you expect of a genuine Volkswagen: economy, reliability and a long service life.

Whether you choose the Delivery van or Kombi model of the Caddy, it is prepared for every task as a delivery or courier vehicle, mobile workshop or conveying passengers. Its ergonomic driver's workplace and generous interior create optimum working conditions. With the Caddy's powerful, economical engines, supreme running gear and comprehensive safety equipment you not only get through but get ahead of the others.



04 – 09
The Delivery van.



10 – 15
The Kombi.



16 – 19
Driver's cab.



20 – 23
Engines.



24 – 27
The Caddy EcoFuel.
28 – 49
Equipment.
Technical data.

Please contact your local Volkswagen Commercial Vehicle Dealer for details of the standard equipment and optional extras applicable in your country.



The Caddy makes light work of weighty matters.



The Caddy Delivery van gets things moving.

Nearly everything to be exact – with a payload of approx. 730 kg or, as an option, as much as 800 kg plus a gross vehicle weight of up to 2.2 t and a trailer weight of up to 1,500 kg. Even when fully loaded, this is hardly noticeable as the Caddy Delivery van has well-balanced driving characteristics in every situation and makes fast progress.

Please contact your local Volkswagen Commercial Vehicle Dealer for details of the standard equipment and optional extras applicable in your country.



There is one thing you always have with you – a whole load of practicality.

Firstly, the load compartment of the Caddy Delivery van is a roomy 3.2 m³. Secondly, it has very easy access through the standard sliding door with an opening width of 70 cm on the front passenger's side, and the second sliding door offered as an extra. A ladder flap is available as an option so that there are no problems in transporting long, bulky items.

You also have the choice of either rear wing doors or a tail-gate. To ensure that you convey every load safely there are six lashing eyes, and a partition to the cab with a plastic mesh section at the top. There is no slipping in the Caddy or your schedule.

Please contact your local Volkswagen Commercial Vehicle Dealer for details of the standard equipment and optional extras applicable in your country.



There is naturally still work to be done – but you do not have to work alone.



**With the Caddy Kombi
everything can easily be
divided by seven.**

At least, if you order the Caddy Kombi with seven seats. You can of course also drive this model as a 5-seater. No matter how many colleagues share the work to be done, they also share driving enjoyment. A lateral sliding door – or, as an option, two – gives very easy access and the comfortable seats assure relaxed travel. This means that everyone can have a breather before again making a combined effort.

Please contact your local Volkswagen Commercial Vehicle Dealer for details of the standard equipment and optional extras applicable in your country.



An ideal environment for a well-established team.

The roomy interior of the Caddy Kombi has four cup holders in the centre console and Delour carpeting for a pleasant working environment. The seating can be adapted to your particular requirements – as the first row of seats in the passenger compartment consists of a single seat and a 2-seater bench seat. Each can be folded down separately depending on how much additional stowage space is required. This assures a high level of flexibility so that your team is prepared for every task.

Please contact your local Volkswagen Commercial Vehicle Dealer for details of the standard equipment and optional extras applicable in your country.



**For specialists with a good grip
on their job.**



All controls at your fingertips in the Caddy.

The cab of the Caddy puts you in a good position. From the comfortable, adjustable front seats you have a good view of the instrument panel and easy to read instruments – as you do of traffic on the road.

Power assisted steering saves effort when parking and there are plenty of well thought out stowage compartments: pockets in the doors, in the headlining and on the instrument panel – and, as an option, large compartments under the front seats; four cup holders in the centre console; and an open glove compartment. The heating and ventilation system which can, as an option, be supplemented by an additional coolant heater creates a pleasant atmosphere. If required, an air conditioner and heated seats are also available. If you so wish, you need hardly lift a finger as the Caddy has central locking plus radio wave remote control as standard, and electric windows can be ordered as optional extras. To be on the safe side, the standard child-proof lock in the Kombi prevents the sliding door from being opened inadvertently. In addition, a driver's airbag is standard and, on the Kombi, a driver's and a front passenger's airbag. All these features make for very relaxing travel.

Please contact your local Volkswagen Commercial Vehicle Dealer for details of the standard equipment and optional extras applicable in your country.



Leave the competition standing.



The range of engines for the Caddy.

The Caddy is way ahead with its five up-to-date engines. Each is powerful and economical – with low consumption and long maintenance intervals.

- 2.0 l SDI engine: 51 kW (69 bhp) and max. torque of 140 Nm*
- 1.9 l TDI engine: 55 kW (75 bhp) and max. torque of 210 Nm**, with DPF as an optional extra
- 1.9 l TDI engine: 77 kW (105 bhp) and max. torque of 250 Nm, with DPF as an optional extra
- 1.4 l petrol engine: 59 kW (80 bhp) and max. torque of 132 Nm
- 1.6 l petrol engine: 75 kW (102 bhp) and max. torque of 148 Nm

In addition to the standard 5-speed gearbox, the double clutch gearbox (DSG) can be ordered for the powerful diesel engine (77 kW). Optimal interaction of the components keeps the shift times short and results in the comfort of an automatic. A diesel particulate filter (DPF) is available as an option for the 77 kW TDI engine.

Whichever power pack you decide on – each engine, in conjunction with the supreme 15" running gear, ensures agile, balanced driving characteristics.

The Caddy is not nonplussed by rain or poor road surface conditions. With standard ABS, TCS and EBC – and ESP+ with brake assist system and trailer stabilisation as an option – stable roadholding is assured whatever the weather. A vehicle with all these advantages simply leaves others standing.

Please refer to page 45 for information on fuel consumption and CO₂ emission.

*Available only for Delivery van.

**Available only for Kombi.

Please contact your local Volkswagen Commercial Vehicle Dealer for details of the standard equipment and optional extras applicable in your country.



Lower fuel costs: with the Caddy EcoFuel, powered by natural gas.

The Caddy EcoFuel helps you to lower your fuel costs as it primarily uses natural gas which is more favourably priced than petrol or diesel. The innovative, 80 kW (109 bhp) 2.0 l engine* has been optimised for operation with natural gas and it burns this type of fuel very efficiently and economically. The steel natural gas tanks in the Caddy EcoFuel have a capacity of 26 kg. In addition, the vehicle has a petrol reserve of 13 litres. If the supply of natural gas has been used up, the Caddy EcoFuel switches over to petrol automatically. The combined amount of natural gas and petrol is enough to cover a distance of some 570 km.

*Please refer to page 45 for information on fuel consumption and CO₂ emission.

Please contact your local Volkswagen Commercial Vehicle Dealer for details of the standard equipment and optional extras applicable in your country.



Puts in a full day's work yet cuts fuel costs.

The Caddy EcoFuel proves its worth every single working day. The manoeuvrability and outstanding space concept of this extremely economical vehicle enable it to cope with every job – safely and reliably. The space-saving underfloor natural gas tank system means that there is an unrestricted load compartment volume of up to 3.2 m³. The Caddy EcoFuel also makes light work of heavy loads – and stows payloads of up to 666 kg.

Performance

Powerful engine with 80 kW (109 bhp).

The “quasi-monovalent” 2.0 l engine in the Caddy EcoFuel ensures that you reach your destination swiftly – with a top speed of 169 kph. “Quasi-monovalent” means that the engine has been optimised for operation with natural gas.

Payload

A load capacity of 666 kg.

The Caddy EcoFuel makes light work of heavy loads – with a maximum payload of 666 kg.

Load compartment

Load compartment volume of 3.2 m³.

The Caddy EcoFuel is also in great shape if you have to transport bulky loads: the natural gas tanks are fitted under the floor so that you have an unrestricted load compartment volume of up to 3.2 m³.



Economy

The Caddy EcoFuel lowers fuel costs.

The Caddy EcoFuel sets new standards in economy. Natural gas is more favourably priced than petrol and diesel, and the 2.0 litre engine burns this type of fuel more economically and efficiently. Extra-urban consumption is only 4.7 kg/100 km. Changing over is worthwhile.

Safety

Comprehensive safety concept.

The unladen weight of 1,604 kg includes comprehensive safety systems for the protection of the driver and load. The steel natural gas tanks are tremendously heat-resistant and have proved to be virtually indestructible in tests under extreme conditions. Electro-magnetic valves with triple protection prevent uncontrolled escape of natural gas in the event of an accident. The Caddy EcoFuel is therefore one of the safest workplaces there is.

Range

A range of up to 570 km.

You can extend your reach with the Caddy EcoFuel: the tank has a capacity of 26 kg of natural gas which is enough to cover a distance of approx. 440 km. A 13 litre reserve supply of petrol lengthens the range by a further 130 km. This adds up to a total of approx. 570 km without having to stop to refuel – hardly any other natural gas vehicle can equal this.

Please refer to page 45 for information on fuel consumption and CO₂ emission.

Please contact your local Volkswagen Commercial Vehicle Dealer for details of the standard equipment and optional extras applicable in your country.

- 01 Uncompromisingly roomy:** the load compartment of the Caddy EcoFuel offers an unrestricted volume of up to 3.2 m³.
- 02 Everything in order:** the Caddy EcoFuel is ideal for all kinds of fittings and fixtures. The natural gas tanks are fitted under the floor.
- 03 Please get in:** the taxi version of the Caddy EcoFuel Kombi has plenty of room for passengers and their luggage.
- 04 Easy refuelling:** a turn of 180° connects the filling device to the filler neck safely and securely.





Equipment – Delivery van and Kombi.



Sliding door

The standard roof-high sliding door on the front passenger's side has an opening width of 70 cm. A second sliding door on the driver's side is available as an option. The Delivery van can also be ordered without sliding doors.



Rear wing doors

The roof-high rear wing doors are divided 2/3 to 1/3. A wiper and heating are available as extras for the rear windows of the Caddy Delivery van. The optional rear wing doors on the Caddy Kombi have a wiper and heated windows as standard.



Alloy wheels, 6.0 J x 15

15" cast aluminium wheels with 195 x 65 R15 tyres.

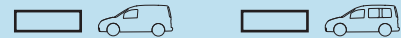

Tailgate

The tailgate of the Caddy Kombi is supplied with a heated rear window and wiper as standard. These features are offered as options for the tailgate of the Caddy Delivery van.



Raised suspension

The raised suspension offers an additional ground clearance of approx. 20 mm and facilitates driving on demanding stretches of road.



Painted bolted-on parts

The bumpers, lateral door handles and door mirrors are colour-keyed. Not available for all paint finishes. Please contact your local Volkswagen Dealer for details.



Protective grille on rear wing door windows

This protects the rear wing door windows when transporting heavy, bulky goods. The grille also provides anti-theft protection for the load compartment.



Ladder flap

The ladder flap enables long and bulky items to be transported with ease. The flap has two gas-filled struts so that it can be opened and closed easily. The cross member serves to retain the ladder flap and the rear wing doors. It can be released by a lever and folded down. The ladder flap is not available for the 7-seater Caddy Kombi.



standard
 optional extra
 special equipment¹

 Delivery van

 Kombi

¹Please refer to page 47 for information regarding special equipment.

Please contact your local Volkswagen Commercial Vehicle Dealer for details of the standard equipment and optional extras applicable in your country.

Equipment – Delivery van and Kombi.



Headlight cleaning system

When the lights are on, the system is activated automatically every fifth time the windscreen is cleaned. A 5.5 l water tank plus a warning lamp in the instrument cluster are included in the specification.



Lashing eyes

The Caddy Delivery van is equipped with six lashing eyes as standard and the Kombi with four.



Fog lights

The fog lights are integrated in the bumpers.

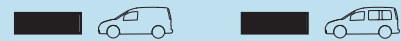

Cloth seat upholstery

The seats in the Caddy Delivery van have “Inca” pattern cloth upholstery, and “Fifty-Five” pattern upholstery in the Caddy Kombi. Both fabrics are in Art Grey. The adjacent illustration shows “Inca” fabric in the Delivery van.



Park distance control

Four sensors in the rear bumper give you acoustic help via a warning buzzer when the Caddy is reversed into a parking space.



Leatherette seat upholstery

As an option, the seats are available in Art Grey “Textile Rhombus” leatherette. The adjacent illustration shows “Textile Rhombus” seat upholstery in the Kombi.



Tow bar

Depending on vehicle type (Delivery van or Kombi) and engine, trailer weights vary from 1,035 kg to a maximum of 1,500 kg. A detachable instead of a fixed tow bar is available as an option for the Kombi (see illustration).

The detachable tow bar is not available for the Caddy EcoFuel.



Headlining

The roomy storage tray on the headlining completes the storage compartment system. The illustration shows “Inca” seat upholstery which is available for the Caddy Delivery van.



Rubber flooring

The Kombi has a Delour floor covering as standard. The floor of the load/passenger compartment and the driver’s footwell can be fitted with a rubber covering as an optional extra.



Roof ventilator

A multi-stage adjustment is possible in the load compartment. The ventilator enables harmful gases to escape, e.g. from paint and adhesives.



standard
 optional extra
 special equipment¹

Delivery van

Kombi

¹Please refer to page 47 for information regarding special equipment.

Please contact your local Volkswagen Commercial Vehicle Dealer for details of the standard equipment and optional extras applicable in your country.

Equipment – Delivery van and Kombi.



Instrument panel

The compartment on the instrument panel is available with a lid plus document clip as an option. Small items of value can be stowed here safely out of sight.



Instrument cluster in conjunction with cruise control

The standard speedometer, rev counter and fuel gauge are complemented by a coolant temperature display and a warning lamp for cruise control. The dot matrix display shows the time, trip recorder and odometer readings. The two large displays have chrome trim rings.



Pockets on driver's and on front passenger's door

Additional stowage space is provided in the cab by pockets on the driver's and on the front passenger's door, and an open glove compartment. As an option, there are large stowage compartments in the Delivery van and spacious drawers under the front seats in the Kombi.



Steering column

The safety steering column can be adjusted for height (+/-20 mm) and rake (+ 30 mm/-20 mm).



Centre console

Four cup holders are integrated in the centre console. The illustration shows "Inca" seat upholstery which is available for the Caddy Delivery van.



Climatic and heated seats

The semi-automatic air conditioner available as an optional extra has infinite temperature control. Heated seats can be ordered as an option for the driver and front passenger. The heating can be adjusted separately for each front seat and the controls are integrated in the central Climatic control unit.



Cruise control

As of a speed of approx. 30 kph, the speed required can be set and is kept at a constant level automatically.



Double clutch gearbox (DSG)

The innovative 6-speed double clutch gearbox (DSG) available for the TDI (77 kW) assures seamless acceleration: engine power continues to be transmitted to the gearbox without interruption between gear-changes. This results in significantly better driving dynamics. Manual or automatic gear-change can be selected.



standard
 optional extra
 special equipment¹

 Delivery van

 Kombi

¹Please refer to page 47 for information regarding special equipment.

Please contact your local Volkswagen Commercial Vehicle Dealer for details of the standard equipment and optional extras applicable in your country.

Equipment – Delivery van and Kombi.



Airbags

The airbag system has a driver's airbag as standard. The specification of the Caddy Kombi includes a front passenger's airbag with deactivation function. A front passenger's airbag is available for the Caddy Delivery van as an optional extra. The range of options also includes side airbags at the front.



R 110 radio

The R 110 radio in the Caddy has four loudspeakers, each with an output of 20 watts. The name of the station is displayed via RDS. Traffic information via traffic programmes is switched on automatically.



ESP

The electronic stabilisation programme ESP+ with brake assist system and trailer stabilisation is available as an optional extra.



RCD 300 radio

With four loudspeakers, a diversity aerial for better reception, and an MP3 compatible CD drive. The radio is available with an external CD changer as an option.



Light + Sight package

The rear view mirror recognises via a photocell when headlights are too bright and dims automatically. A rain sensor registers the amount of rain on the windscreen and regulates the windscreen wipers. A light sensor switches the vehicle's lights on automatically when it gets dark (twilight, tunnels etc.).



RCD 500 radio

As for RCD 300 radio. In addition: an integral MP3 compatible 6-disc CD changer. An external CD changer is available as an optional extra.



AUX-In

As an option, an AUX-In connection is available for the open glove compartment. This enables equipment such as an MP3 player or portable CD player to be connected to a car radio with changer control. Sound reproduction for portable equipment connected to the RCD 300 and RCD 500 radios or the two Radio Navigation Systems is via the speakers of the built-in radios.

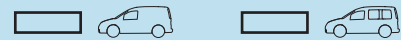

RNS 300 Radio Navigation System

The RNS 300 Radio Navigation System with arrow navigation and text display. This system is MP3 compatible and enables audio CD and navigation functions to be used simultaneously. An external CD changer is also available as an optional extra.



Mobile phone fixture/provision for mobile phone with Bluetooth

A mobile phone fixture incl. a "Nokia 6021" can be ordered as an option (see illustration). Provision for a mobile phone (incl. hands-free facility) can be ordered without a mobile phone. Please contact your local Volkswagen Dealer or refer to www.zubehoer-service.de for details of the current range of adapter cradles suitable for various types of mobile phones.



RNS 500 Radio Navigation System

This Radio Navigation System with colour display offers dynamic route guidance. The system uses data from a navigation DVD which includes most countries in Europe. The drive can also play audio CDs. An external CD changer is also available as an optional extra.



■ standard

□ optional extra

■ special equipment¹

🚐 Delivery van

🚐 Kombi

¹Please refer to page 47 for information regarding special equipment.

Please contact your local Volkswagen Commercial Vehicle Dealer for details of the standard equipment and optional extras applicable in your country.

Equipment – Delivery van.



Window in sliding door

The window in the sliding door provides additional light in the load compartment.



Full partition

In conjunction with the option of a higher payload of 800 kg, a full partition made of metal is supplied (see illustration). The lower part of the standard partition to the cab consists of a plastic surface and the upper part of plastic mesh.



Diagonal ventilation

The diagonal ventilation system facilitates optimal ventilation of the load compartment when carrying hazardous freight. Ventilation is via a roof ventilator and a ventilation system on the right-hand side.



Plexiglass cover for mesh partition

The mesh partition behind the driver's and front passenger seat can be covered using Plexiglass panels. This keeps odours from the load away from the driver. Diagonal ventilation can also be ordered as an ideal complement to this feature.

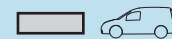

Flex Plus seat package

The front passenger seat can be folded in the footwell to create a through-loading facility for the convenient transport of long or bulky loads. The package consists of a double-folding front passenger seat and a pivoting partition.



Partial trim

The load compartment is well-protected by half-height hardboard side panel trim. The interior roof trim in the load compartment is also made of hardboard.



Lashing rails on side panels

Practical lashing rails on the side panels ensure safe transport in the load compartment.

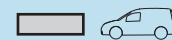

Wooden flooring

The robust wooden flooring of the Caddy Delivery van protects the load compartment floor. The flooring is made of laminated wood and is waterproof.

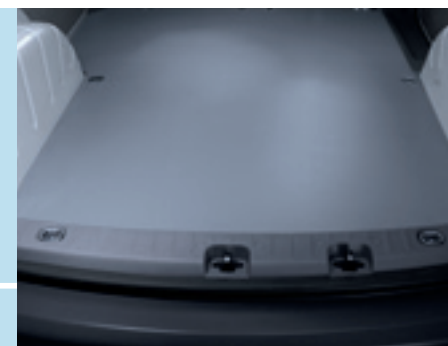
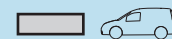

■ standard

□ optional extra

■ special equipment¹

🚐 Delivery van

🚐 Kombi

¹Please refer to page 47 for information regarding special equipment.

Please contact your local Volkswagen Commercial Vehicle Dealer for details of the standard equipment and optional extras applicable in your country.

Equipment – Kombi.



Passenger compartment, Kombi

The Caddy Kombi has a 3-seater bench seat in the first row of seats in the passenger compartment as standard. A 2-seater bench seat can be ordered as an extra for the second row of seats in the passenger compartment. The illustration shows “Fifty-Five” pattern fabric in the Caddy Kombi.



3-seater bench seat, Kombi

The 3-seater bench seat in the passenger compartment of the Kombi consists of a single seat and a 2-seater bench seat. Each seat can be folded down or double folded separately.



Pockets in passenger compartment

Two additional storage compartments in the footwell of the first row of seats in the passenger compartment complete the storage compartment system. If the vehicle is equipped with a detachable tow bar as an option, the detachable ball head is stowed in one of the compartments.



ISOFIX child's seat mounting points

The ISOFIX child's seat mounting points are under a zip on the outer seats of the 3-seater bench seat. These enable child's seats to be securely connected to the vehicle structure.



Luggage compartment cover and net partition

A folding luggage compartment cover is available for the Caddy Kombi as an optional extra to screen the compartment from view. A net partition available as an optional extra keeps the load under control even during sudden braking manoeuvres. The net partition can be rolled together when not required.



Volkswagen Genuine Accessories.

Mud flaps at front and rear

The mud flaps are designed for an exact fit on the front and rear wings. They protect the underbody, bumpers and rear end from dirt, stone damage and water spray.



Mesh partition

The robust, black powder-coated steel mesh partition keeps the load under control, also during sudden braking manoeuvres. It can quickly and easily be secured to the lashing eyes – and just as easily removed again.



Luggage net

This prevents light loads and luggage from slipping in the load compartment. Securing hooks on the net enable it to be fastened to the standard lashing eyes.



Basic carrier with ladder clamp

The basic carrier is made of aerodynamically shaped aluminium profile bars with plastic cover caps and is the basis for all attachments. It has theft-deterrent fasteners and a mechanism of galvanised, coated sheet steel. Net weight approx. 5.6 kg. City crash tested. The illustration shows the basic carrier with a ladder clamp that can be ordered as a supplement.



Basic roof carrier with luggage basket

The very robust, weatherproof luggage basket is made of fully galvanised steel tubing and provides additional facilities to carry loads and luggage. Exterior dimensions: 101 x 76 x 14 cm.



■ standard

□ optional extra

■ special equipment¹

🚐 Delivery van

🚐 Kombi

¹Please refer to page 47 for information regarding special equipment.

Volkswagen Genuine Accessories are only available at your Volkswagen Dealer.

Please contact your local Volkswagen Commercial Vehicle Dealer for details of the standard equipment and optional extras applicable in your country.

Volkswagen Genuine Accessories.



Luggage compartment insert

This flexible, made to measure insert has an approximately 5 cm high rim to protect the load compartment from moisture and dirt. When not in use, the insert can be rolled up to save space.



Luggage compartment tub

This extremely robust Hostalen insert is ideal for everything that could soil the luggage compartment during transport. The tub is acid-resistant, protects from dirt and is easy to clean.

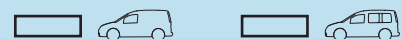

Technical data.

Petrol engines

	1.4 l petrol engine (59 kW) ¹	1.6 l petrol engine (75 kW) ¹
Mixture preparation/injection method	multi-point injection (MPI)	multi-point injection (MPI)
No. of cylinders	4	4
Cubic capacity, cm ³	1,390	1,598
Output, kW at rpm	59 at 5,000	75 at 5,600
Max. torque, Nm/rpm	132/3,800	148/3,800
EU exhaust emission directive	according to 98/69/EC I B, EURO 4	according to 98/69/EC I B, EURO 4
5-speed manual gearbox	standard	standard
6-speed double clutch gearbox (DSG)	–	–
Front-wheel drive	standard	standard
Type of fuel	premium unleaded DIN EN 228, 95 RON ³	premium unleaded DIN EN 228, 95 RON ³

Diesel engines

	2.0 l SDI engine (51 kW) ¹ (available only for Caddy Delivery van)	1.9 l TDI engine (55 kW) ¹ without/with diesel particulate filter (DPF) ²
Mixture preparation/injection method	naturally aspirated diesel with unit injector direct injection	turbo-diesel with unit injector direct injection
No. of cylinders	4	4
Cubic capacity, cm ³	1,968	1,896
Output, kW at rpm	51 at 4,200	55 at 4,000
Max. torque, Nm/rpm	140/2,200 – 2,400	210/1,900
EU exhaust emission directive	according to 98/69/EC II B, EURO 4	according to 98/69/EC I B, EURO 4
5-speed manual gearbox	standard	standard
6-speed double clutch gearbox (DSG)	–	–
Front-wheel drive	standard	standard
Type of fuel	diesel, in accordance with DIN EN 590	diesel, in accordance with DIN EN 590

Diesel engines

	1.9 l TDI engine (77 kW) ¹ without/with diesel particulate filter (DPF) ²
Mixture preparation/injection method	turbo-diesel with unit injector direct injection
No. of cylinders	4
Cubic capacity, cm ³	1,896
Output, kW at rpm	77 at 4,000
Max. torque, Nm/rpm	250/1,900
EU exhaust emission directive	according to 98/69/EC I B, EURO 4
5-speed manual gearbox	standard
6-speed double clutch gearbox (DSG)	combination possible
Front-wheel drive	standard
Type of fuel	diesel, in accordance with DIN EN 590

EcoFuel

	2.0 l natural gas engine (80 kW) ¹
Engine concept	quasi-monovalent ⁴ (petrol engine optimised for operation with natural gas)
No. of cylinders	4
Cubic capacity, cm ³	1,984
Output, kW at rpm	80 at 5,400
Max. torque, Nm/rpm	160/3,500
EU exhaust emission directive	according to 98/69/EC I B, EURO 4
5-speed manual gearbox	standard
6-speed double clutch gearbox (DSG)	–
Front-wheel drive	standard
Type of fuel	natural gas (CNG) ⁵ /Super plus DIN EN 228, 98 RON ⁶

standard
 optional extra
 special equipment¹

Delivery van
 Kombi

¹Please refer to page 47 for information regarding special equipment.

Volkswagen Genuine Accessories are only available at your Volkswagen Dealer.

Please contact your local Volkswagen Commercial Vehicle Dealer for details of the standard equipment and optional extras applicable in your country.

¹ Please refer to page 45 for information on fuel consumption and CO₂ emission.

² Diesel particulate filter is available as an optional extra.

³ 91 RON regular fuel may be used in which case a slight decrease in performance or higher fuel consumption must be reckoned with.

⁴ Primary natural gas mode; secondary petrol reserve mode.

⁵ H or L gas. It is possible to use bio gas.

⁶ 95 RON unleaded premium fuel may be used in which case a slight decrease in performance or higher fuel consumption must be reckoned with.

Performance.

Performance with manual gearbox (without additional equipment, on vehicles registered as trucks plus half payload)

Engine	Output (kW)	Acceleration (kph, s)		Flexibility (kph, s) 80 – 120 (4th/5th gear)	Top speed (kph)
		0 – 80	0 – 100		
1.4 l petrol	59	10.5	16.6	14.9/20.4	151
1.6 l petrol	75	9.1	13.7	13.4/19.1	164
2.0 l SDI	51	12.3	20.5	21.7/23.9	142
1.9 l TDI	55	11.2	17.7	17.1/19.2	150
1.9 l TDI	77	8.8	13.3	11.6/13.7	166
2.0 l natural gas	80	9.2	13.8	14.0/20.0	169

Performance with double clutch gearbox (DSG) (without additional equipment, on vehicles registered as trucks plus half payload)

Engine	Output (kW)	Acceleration (kph, s)		Flexibility (kph, s) 80 – 120 (top gear)	Top speed (kph)
		0 – 80	0 – 100		
1.9 l TDI	77	8.8	13.3	10.8	166

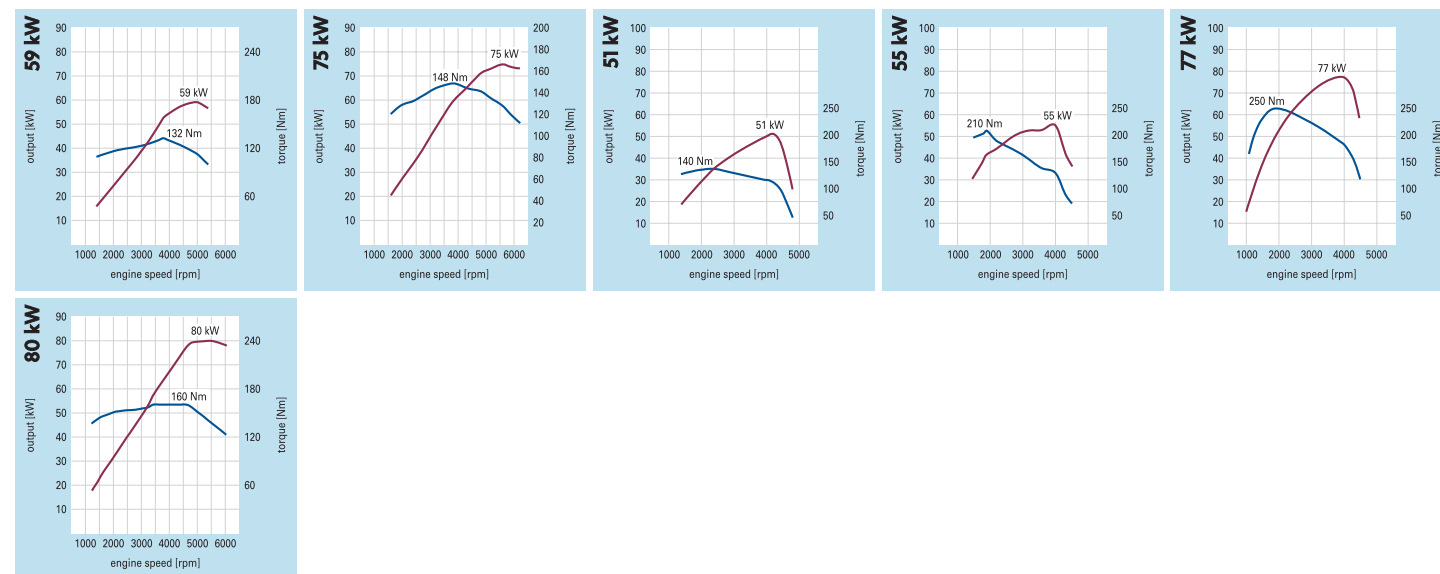

Fuel consumption/CO₂ emission.

Fuel consumption (litres/100 km) and combined CO₂ emission (g/km), tank contents approx. 60 litres

Engine/model	1.4 l petrol (59 kW)	1.6 l petrol (75 kW)	2.0 l SDI ¹ (51 kW)	1.9 l TDI (55 kW) without DPF/with DPF	1.9 l TDI (77 kW)		DSG	DSG and DPF
					manual gearbox	manual gearbox and DPF		
urban	10.3	10.8	7.5	7.4/7.6	7.5	7.6	8.3	8.3
extra-urban	6.7	6.9	5.3	5.2/5.6	5.3	5.6	5.8	6.0
combined	8.0	8.3	6.1	6.0/6.3	6.1	6.3	6.7	6.9
CO ₂ emission combined	191	198	161	158/167	161	167	177	182

Caddy Delivery van and Caddy Kombi 5/7-seater

Engine/model	1.4 l petrol (59 kW)	1.6 l petrol (75 kW)	2.0 l SDI ¹ (51 kW)	1.9 l TDI (55 kW) without DPF/with DPF	1.9 l TDI (77 kW) manual gearbox	1.9 l TDI (77 kW) manual gearbox and DPF	DSG	DSG and DPF
urban	10.3	10.8	7.5	7.4/7.6	7.5	7.6	8.3	8.3
extra-urban	6.7	6.9	5.3	5.2/5.6	5.3	5.6	5.8	6.0
combined	8.0	8.3	6.1	6.0/6.3	6.1	6.3	6.7	6.9
CO ₂ emission combined	191	198	161	158/167	161	167	177	182

Caddy EcoFuel Delivery van and Caddy EcoFuel Kombi 5/7-seater

Consumption² and CO₂ emission with natural gas (H gas), natural gas (or petrol) tank contents approx. 26 kg/35.6 m³ (or approx. 13 litres)

2.0 l natural gas engine (80 kW)	Consumption		CO ₂ emission	
	urban	extra-urban	combined	CO ₂ emission combined
urban	8.2 kg/100 km	4.7 kg/100 km	12.1 m ³ /100 km	157 g/km
extra-urban	4.7 kg/100 km	6.0 kg/100 km	6.8 m ³ /100 km	157 g/km
combined	6.0 kg/100 km	157 g/km	8.8 m ³ /100 km	157 g/km
CO ₂ emission combined	157 g/km	157 g/km	157 g/km	157 g/km

¹ Available for Caddy Delivery van only.

² The data given here in kg/100 km is for information purposes only.

When L gas is used, large fluctuations in the quality of the fuel can result in differing figures for performance and, in particular, for fuel consumption.

The figures listed here have been established in accordance with the measuring method stipulated (the version of directive 80/1268/EEC which is currently valid). These figures do not refer to a particular vehicle and do not constitute part of the offer but are purely for comparison purposes between the various types of vehicle.

In addition to the fuel efficiency of a vehicle, driving behaviour as well as other non-technical factors play a role in determining a vehicle's fuel consumption and CO₂ emission. CO₂ is the main greenhouse gas responsible for global warming.

Note in accordance with directive 1999/94/EC: a guide on fuel consumption and CO₂ emission which contains data for all new passenger car models is available free of charge at every point of sale in the European Union and, for prospective buyers in Germany, at DAT Deutsche Automobil Treuhand GmbH, Hellmuth-Hirth-Strasse 1, 73760 Ostfildern.

Weights.

Engine	Output (kW)	Gross vehicle weight (kg)	Unladen weight with driver (kg) ¹ from – to	Payload (kg) from – to	Axle load limit front/rear (kg)	Trailer weight braked, 12%/8% gradient (kg)	Trailer weight unbraked (kg)	Gross train weight, 12%/8% gradient (kg)
Caddy Delivery van								
1.4l petrol	59	2,130	1,400 – 1,518	730 – 612	1,050/1,200	1,200/1,400	700	3,200/3,530
1.6l petrol	75	2,152	1,422 – 1,540	730 – 612	1,050/1,200	1,300/1,500	710	3,300/3,652
2.0l SDI	51	2,185	1,455 – 1,573	730 – 612	1,050/1,230	1,400/1,500	720	3,500/3,685
1.9l TDI	55	2,205	1,481 – 1,599	724 – 606	1,065/1,230	1,400/1,500	740	3,550/3,705
1.9l TDI	77	2,211	1,481 – 1,599	730 – 612	1,065/1,230	1,500/1,500	740	3,600/3,600
1.9l TDI with DSG	77	2,240	1,510 – 1,628	730 – 612	1,090/1,230	1,500/1,500	750	3,740/3,740
2.0l natural gas	80	2,270	1,604 – 1,722	666 – 548	1,090/1,250	1,300/1,500	750	3,400/3,770
Caddy Kombi 5-seater								
1.4l petrol	59	2,000	1,485 – 1,597	515 – 403	1,000/1,200	1,200/1,400	700	3,200/3,400
1.6l petrol	75	2,186	1,504 – 1,616	682 – 570	1,000/1,200	1,300/1,500	710	3,300/3,686
1.9l TDI	55	2,035	1,569 – 1,681	466 – 354	1,065/1,200	1,400/1,500	750	3,435/3,535
1.9l TDI	77	2,251	1,569 – 1,681	682 – 570	1,065/1,200	1,500/1,500	750	3,600/3,600
1.9l TDI with DSG	77	2,280	1,598 – 1,710	682 – 570	1,095/1,200	1,500/1,500	750	3,780/3,780
2.0l natural gas	80	2,186	1,686 – 1,798	500 – 388	1,030/1,200	1,200/1,500	750	3,386/3,686
Caddy Kombi 7-seater								
1.4l petrol	59	2,167	1,522 – 1,634	645 – 533	1,000/1,200	1,035/1,400	700	3,202/3,567
1.6l petrol	75	2,186	1,541 – 1,653	645 – 533	1,000/1,200	1,115/1,500	710	3,301/3,686
1.9l TDI	55	2,251	1,606 – 1,718	645 – 533	1,065/1,200	1,300/1,500	750	3,551/3,751
1.9l TDI	77	2,251	1,606 – 1,718	645 – 533	1,065/1,200	1,350/1,500	750	3,601/3,751
1.9l TDI with DSG	77	2,280	1,635 – 1,747	645 – 533	1,095/1,200	1,500/1,500	750	3,780/3,780
2.0l natural gas	80	2,270	1,723 – 1,816	547 – 454	1,030/1,250	#/#	#	#/#

¹ Additional equipment may alter the unladen weight of the vehicle in which case the payload, performance, fuel consumption and CO₂ emission are affected.
Tow bar is not available.

Roof load limit/trailer nose weight: Delivery van 100 kg//80 kg, Kombi 100 kg/75 kg.

Dimensional drawings.

Caddy Delivery van/Caddy EcoFuel Delivery van

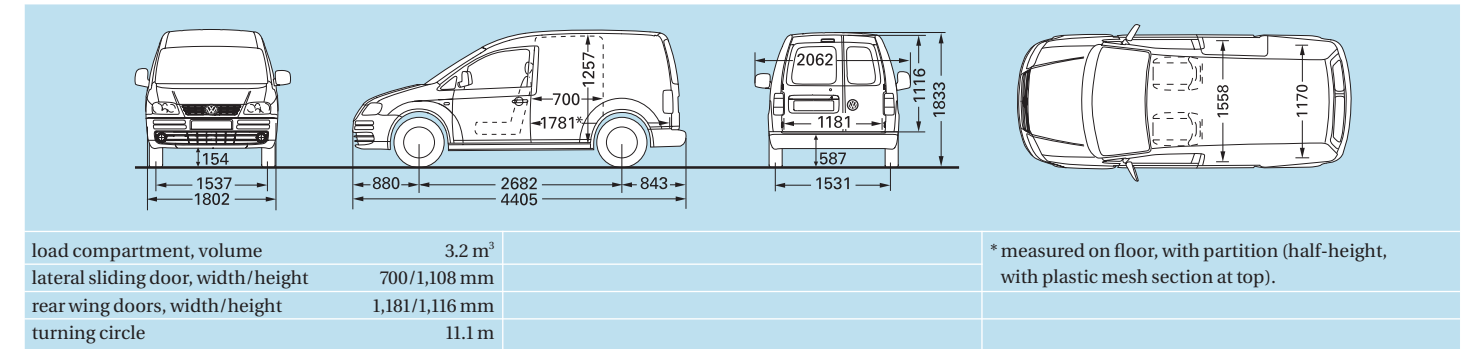

Caddy Kombi 5-seater/Caddy EcoFuel Kombi 5-seater

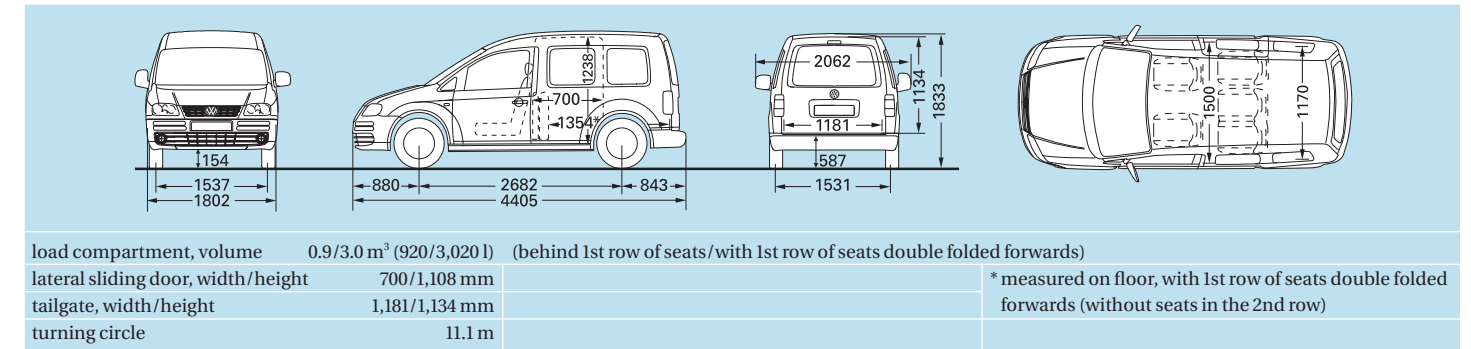

Caddy Kombi 7-seater/Caddy EcoFuel Kombi 7-seater

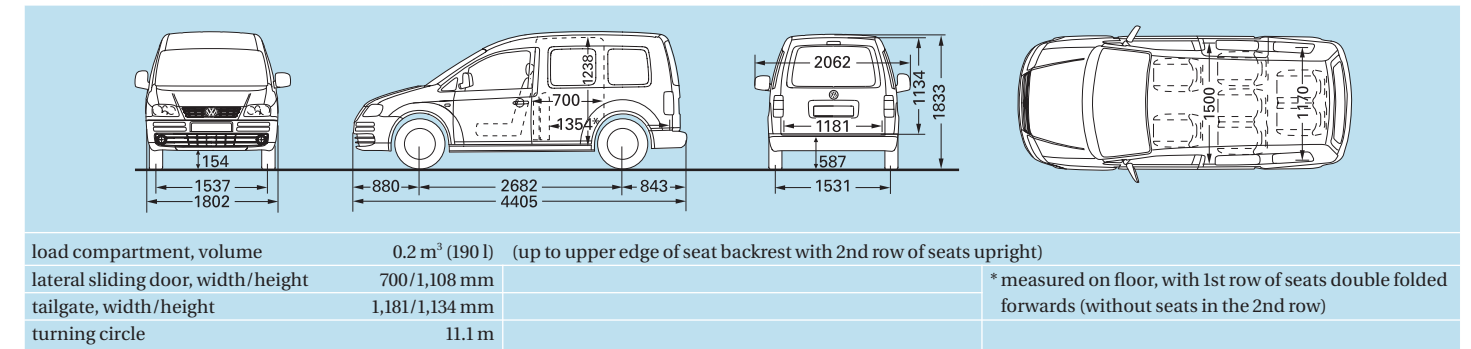

The height measurements listed here can differ by approx. ± 50 mm depending on equipment.
The vehicle drawings are not to scale.

For commercial use: in accordance with EU directive 3820/85, a tachograph is stipulated by law as of a gross train weight of 3.5 tonnes. A tachograph is not available for the Caddy ex factory nor can it be fitted subsequently. This means that if the vehicle is used commercially, a gross train weight (GVW of towing vehicle plus GVW of trailer) of 3.5 tonnes must not be exceeded.

Some of the vehicles shown are equipped with optional extras at extra charge. Decoration contained in the illustrations is not included in the standard specifications. The data given here on specifications, appearance, technical data and operating costs of the vehicles is in accordance with the information available at the time of going to print. All details of equipment and technical data are based on the features of the German market. Subject to change without notice. The product name Caddy is used by Volkswagen Commercial Vehicles with the approval of Caddie S.A. TDI® and DSG® are registered trademarks of Volkswagen AG in Germany and in other countries.

If vehicles are ordered with options classified as “special equipment” this can lead to longer delivery periods.

Take-back and recycling of end of life vehicles

VOLKSWAGEN meets the challenges of modern society and takes them into consideration in all new products of the VOLKSWAGEN brand. This naturally also applies to protection of the environment and resources. All new VOLKSWAGENS can therefore be recycled in an environment-friendly way and can be returned in EU countries free of charge, subject to fulfilment of national legislation.

Please contact your local Volkswagen Dealer for details concerning the take-back and recycling of end of life vehicles or refer to www.volkswagen.de.



Paint finishes.

Solid paints	Candy White B4B4	Flannel Grey B9B9	Stone Blue 1E1E	Surf Blue 1C1C	Danish Blue 2D2D
	Tornado Red G2G2	Paprika Red H7H7	Bright Orange E3E3	Lime W5W5	Lambda Green F9F9
Metallic paints*	Reflex Silver 8E8E	Off-Road Grey M3M3	Ravenna Blue 5Z5Z	Shadow Blue P6P6	Fresco Green 3P3P
	Red Spice K7K7				
	Black Magic Z4Z4				
Pearl effect paints*					

Seat upholstery.

Upholstery colours	Inca/Art Grey** AN	Fifty-Five/Art Grey*** BN	Textile Rhombus/ Art Grey leatherette MB

The illustrations on these pages can only be regarded as a general guide as the printing process cannot render the colours with absolute accuracy.

*Available at extra charge.
 ** The upholstery "Inca/Art Grey" is only available for the Caddy Delivery van.
 *** The upholstery "Fifty-Five/Art Grey" is only available for the Caddy Kombi.

The Caddy

765.1192.10.18 • Printed in Germany
Subject to change without notice
Issue: May 2007

Internet: www.vwn.de