



308



PEUGEOT



THE RIGHT CHEMISTRY

WHEN YOU CHOOSE A PEUGEOT, YOU'RE BUYING MORE THAN AN ELEGANT PIECE OF DESIGN OR A SUPERB PIECE OF ENGINEERING, YOU'RE BUYING A VISION – OUR DREAM OF A MARQUE THAT EMBODIES YOUR DESIRES AND MEETS YOUR EXPECTATIONS IN EVERY WAY. A VEHICLE THAT IS THE VERY PERSONIFICATION OF THE PEUGEOT SPIRIT.

This spirit, or essence, of our marque can be summed up in four words. Style, quality, dynamism and innovation – the values that every Peugeot is created around. So what does that mean to you? It means beauty, stunning design, pure Peugeot lines, the very quintessence of aesthetics as seen by top Peugeot designers.

Or roughly translated, a car that makes your heart beat faster every time you look at it.

It means a car that you can trust. Every new Peugeot is engineered to the very highest standards to achieve optimum active and passive safety, ensuring technical excellence, superb handling plus peace of mind.

It also means passion. Our passion for creating cars with real poise and precision, cars that communicate with the road and connect with you, lifting your spirits on every journey. Cars that re-awaken your enthusiasm for driving.

It goes without saying that it means intelligent, innovative designs and features that answer your demands for better, safer, more comfortable and environmentally respectful vehicles. We've reduced emissions from our engines and every new car we build is at least 90% recyclable.

These are the strands of Peugeot DNA that you'll find running through every vehicle that bears our name today, and every car that we'll build tomorrow. Creating the perfect chemistry between you and your car.

308



Discover //	4
Lead //	16
Protect //	22
Choose //	24
Peugeot and You //	31

Discover //



BUILT TO PERFECTION

How can you tell when you've achieved perfection?

When you've refined every detail until you can't improve it any further? When all the individual components come together to make one, beautifully balanced whole, just as they do in the Peugeot 308?

One look at its sleek V-shaped bonnet, the wide, cat-like headlights, the distinctive front grille with its aluminium louvres and the deeply recessed fog lights, and you don't have to be told that, in its class, this car can't be bettered.

You just know.





PERFECTLY POISED

Even at a standstill, the 308 looks poised, ready for action.

Its perfect balance of height and length, combined with a commanding, wide wheelbase give it a purposeful stance.

The taut body line running the length of its side from the rear shoulder to the front wheel arches gives it a feeling of momentum. The pronounced, flat wheel arches and the large wheels hint at the dynamic performance to come.

While from the rear, the wrap-around window and muscular sports bumper with chrome highlights* simply confirm its intentions.

If you like what you see on the surface of the 308, you'll be even more impressed when you discover what lies beneath.

*XTE model.

ENDLESS POSSIBILITIES



The spacious new 308 Touring is versatile in more ways than one.

Not only is it more powerful than its predecessors, it's also stronger, lower and wider with the ability to accommodate up to seven passengers*. The fact that you can rearrange the rear seating into over 50 different seating configurations means it fits perfectly with any lifestyle. So revolutionary is the Touring's modular interior that it won an Australian International Design Award (Automotive & Transport category) in 2009.

The body has also been designed to reflect the car's versatility, by combining a particularly expressive and dynamic design at the front with an original and curvaceous shape at the rear. A sloping design adds elegance whilst flowing lines reinforce the impression of space and on-board comfort.

Beyond that, the 308 Touring boasts some very practical features such as a panoramic glass roof and wrap-around rear windscreen which all aim to increase natural light and enhance your driving experience.

*6th and 7th seats optional at extra cost





DESTINATION PERFECTION

When we designed the interior of the 308, we wanted it to provide truly superior comfort. So one of our top priorities was to make sure that everyone had plenty of space to stretch out.

Part of our solution was to angle the dashboard by 30 degrees, freeing up space around the driver's and front seat passenger's knees. We also gave them comfortable yet slim-backed sports seats, which created a few valuable extra inches of leg room for the rear passengers.

But we didn't stop at giving the 308 more cabin space.

To boost comfort levels even higher, we raised the back seats –

treating occupants to improved visibility. And just to make the car feel really spacious and airy we designed in a huge panoramic rear window.

More clever thinking went into ensuring that the interior of the 308 was a really calm place to be. We built in high levels of sound insulation. We fitted a photosensitive rear-view mirror* to prevent the driver from being dazzled by the car behind.

The little things were big priorities too. Like making sure that there were plenty of places to stow away all your family's bits and pieces, including a centre armrest that's big enough to hold six CDs, plus an air-conditioned glovebox.



We didn't want you to be left in the dark when light levels started to fall either. That's why you'll find courtesy lights in the front and centre of the roof, as well as in the boot.

So, did we succeed in making the 308 one of the most comfortable places to be on the road? Well, we can honestly say we think you'll be impressed.

A touch of class

Part of the 308's beauty is in the details. Evidence of our commitment to quality can be found in features like the specially woven seat trim.

*XTE model.



Beige leather – option on XSE and XTE models

CREATE YOUR OWN SPACE



The 308 Touring was designed to allow you to create the environment you want. This is done by giving you the ability to literally re-sculpture the inside of your car to fit your personal lifestyle requirements. The three seats in the 2nd row are independent and interchangeable, and can slide, fold away, be removed completely or even placed in the 3rd row. You also have the option of two independent, foldable and

removable 3rd row seats* – perfect for when you have unexpected company. And you will still have room for additional luggage thanks to its extremely generous boot size.

Comfort for every passenger is at the heart of the 308 Touring. Its unique 2nd row seating features backrests that have the

*available at extra cost

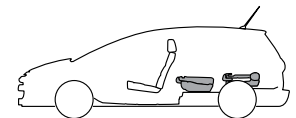
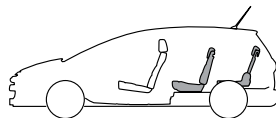



ability to recline at an angle of between 19 and 30 degrees, allowing each passenger to individually adjust the angle to which they are most comfortable. The 2nd row seats also have the advantage of being able to slide over a distance of 90mm, increasing rear leg room or creating extra space in the load area which is handy

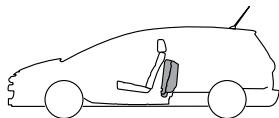

when transporting extra bulky items.

From snowboarding to mountain bike riding to weekends away with the whole family, the award-winning 308 Touring has been designed to do what you want it to do. So you can just relax, sit back and enjoy the ride.

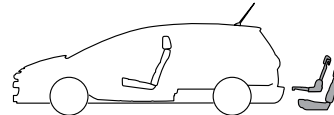

SEE DRIVING IN A NEW LIGHT



Getting into the 308 for the first time is a very enlightening experience.

Not content with giving the 308 the largest expanse of window glass in its class (3.6 m²), for a virtually unobscured view of the road, we've also given it a huge, panoramic glass roof* which lets light flood in from outside to give you an amazing sense of freedom and space. This increases the glass area to an incredible 4.86 m² (Hatch) or 5.58 m² (Touring). Stretching an incredible 1.26 m² (1.68 m² for Touring), the roof effectively extends the stylishly raked windscreen right to the back of the

passenger compartment, brightening up everyone's journey.

Worried about your passengers getting too much sunshine? Don't be. The heat-reflective, tinted glass has been treated to filter out 90% of the sun's ultraviolet rays.

And if the sun really starts to shine down, an electric sunblind is ready to cover up all or part of the roof at the touch of a button. There's even a thoughtful anti-pinch system to stop it operating if little fingers get in the way. Yes, the 308 could seriously change your outlook on driving.

*Standard on XTE and Touring, optional on XSE models.



Lead //

SETTLE DOWN IN THE DRIVING SEAT OF THE 308 AND YOU KNOW YOU'RE ON THE ROAD TO THE PERFECT DRIVING EXPERIENCE.

THE PERFECT DRIVING PARTNER

As if our knowledge and experience plus our passion for developing drivers' cars weren't invitation enough, the 308's rigid chassis, low centre of gravity and wide wheelbase positively beg you to put its outstanding driving dynamics to the test.

Braking hard into a corner? You'll be pleased to know that the 308's brakes are the best in its class, featuring extra-large ventilated discs on the front for more bite and endurance without a hint of vibration.

Storm clouds looming? The 308's already ahead of you. As soon as the first drops hit, the intelligent sensor* at the top of the windscreen will activate the wipers, which speed up to match the intensity of the rain. And if the light levels start to fall too, the same sensor will turn on the headlights for you.

The 308 can also see you safely to and from your door at night. The headlights stay on to light your way for a few seconds after you've used the plip key to lock the car.

Equally important, the 308 can take care of itself. The fuel filler cap can only be opened with a key, and it has a coded anti-start device to discourage unwanted admirers.

*Standard on XSE and XTE models.

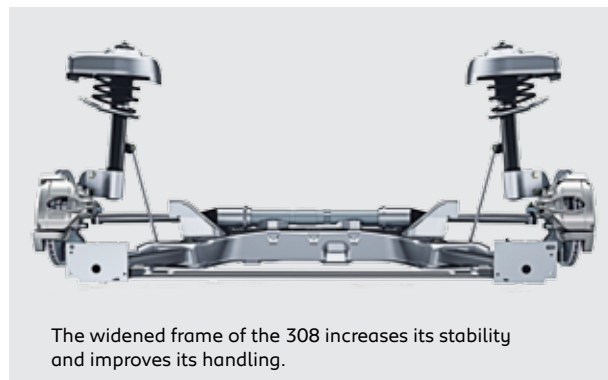

The widened frame of the 308 increases its stability and improves its handling.



AT PEUGEOT, WE GO TO GREAT LENGTHS IN THE PURSUIT OF PERFECTION. WHICH IS ONE OF THE REASONS WE ARE NOW THE WORLD LEADER IN DIRECT-INJECTION DIESEL ENGINES, AND WHY WE'RE PUSHING THE BOUNDARIES OF TECHNOLOGY TO PRODUCE MORE FUEL-EFFICIENT ENGINES AND REDUCE EMISSIONS.

A NEW WORLD POWER

OUR LATEST PETROL AND DIESEL ENGINES ARE THE RESULT OF THAT PASSION, OFFERING THE PERFECT COMBINATION OF FUEL ECONOMY, FLEXIBILITY AND DRIVING PLEASURE.

HDi turbo diesel engines (High-pressure Direct Injection)

The success of our refined HDi diesels is a case in point. A Peugeot innovation, they incorporate a particulate filter (FAP) along with a pump that feeds fuel into a 'common rail' and they are renowned for their remarkable fuel-efficiency, high levels of torque (even at low revs) plus their radically low CO₂ emissions.

With an additional 20Nm torque using the overboost function, this very intelligent application of power also means that they are extremely rewarding to drive.

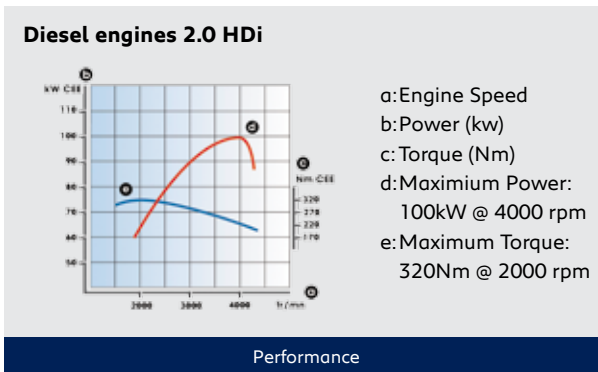

Diesel engines	Maximum power (kW @ rpm)	Maximum torque (Nm @ rpm)	Maximum speed (km/h)
1.6 HDi	80 @ 4000	240 @ 1750	190
2.0 HDi	100 @ 4000	320 @ 2000	205 / 200

Clean, efficient diesel power is supplied by either the responsive 80kW, 1.6 HDi or the impressive 100kW, 2.0 HDi.

Petrol engines

The 308's range of next generation petrol engines boast a host of technological innovations to give you an immediate response. More low end torque along with more constant torque throughout the rev range means you don't have to keep changing gear to get the most out of the engines. Combining smooth power with high efficiency, these engines set new standards for performance, dynamism and CO₂ emissions.

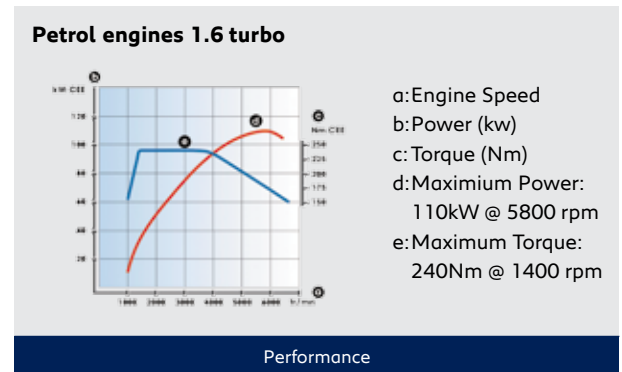

Petrol engines	Maximum power (kW @ rpm)	Maximum torque (Nm @ rpm)	Maximum speed (km/h)
1.6	88 @ 6000	160 @ 4250	195 / 188
1.6 turbo	110 @ 5800 (man) 103 @ 6000 (auto)	240 @ 1400	213 / 202

The responsive, fuel injected 1.6 litre turbo engine develops 110kW (103kW for auto) of power and features variable valve timing (VVT). It delivers power exactly when you need it to ensure you can enjoy the 308's dynamic capabilities to the full. A precise manual or a Tiptronic automatic gearbox (103kW engine only) helps you make the most of its performance.



ENGINEERING INTELLIGENCE

EGC Electronic Gearbox Control

In addition to the slick manual and smooth Tiptronic automatic transmissions which are available across the 308 range, the 308 hatch in combination with the 1.6 HDi diesel engine is now available with the new Electronic Gearbox Control (EGC) transmission.

EGC is a new six-speed transmission that is controlled by state of the art electronics. It can be driven by either manually changing gears, without a clutch pedal, or automatically by allowing the electronics to do all the work.

But you will always be in complete control. The system allows you to alternate between sequential and automatic modes at any time, providing greater flexibility for different driving conditions.

Fully automatic

In automatic mode, simply put the gear lever in "A" and let the ECU do all the work.

Sequential mode

In sequential mode, the driver can either change gears sequentially from the gearbox, or by the steering wheel-mounted paddles – F1 style.

The introduction of the EGC is timely and relevant in today's economic climate thanks to its significantly lower fuel consumption and CO₂ emissions when compared to traditional automatic technology. The HDi engine, when combined with the EGC, achieves a remarkable combined consumption figure of just 4.7 litres/100km and CO₂ emissions of 125g/km. With its 60 litre tank it means you could travel over 1200km on a single tank.

All in all, the EGC transmission makes for an extremely engaging and rewarding driving experience.





PEUGEOT AND THE

Fact: climate change is one of the biggest challenges facing the planet. Sadly, we can't ignore the automobile's contribution to the greenhouse effect. Or turn back time.

So at Peugeot for some years now we've been concentrating on what we can do – to build vehicles with the future in mind.

Because we're genuinely committed to reducing CO₂ emissions, we've invested heavily in new technologies and innovations designed to make our cars more fuel-efficient (believe it or not, we've even been developing biofuels from plants that absorb CO₂ while they're growing).

We've also got on with the job of cleaning up the air. We pioneered the use of the FAP particulate filter in HDi diesel engines, significantly reducing the amount of polluting particles released in the air.

Our hard work is continuing to pay off. We've managed to reduce the CO₂ emissions from the 308's 1.6 HDi engine to just 125g/km

(in conjunction with the 6 speed EGC) in the combined cycle.

So we can all breathe easier, we're switching away from using paints containing organic solvents, opting instead for water-based alternatives that discharge nearly five times fewer volatile organic compounds into the atmosphere, yet still look as good and last as well as their more noxious counterparts. We've even been looking at ways to replace the HFC used in our air-conditioning systems.

Worried about landfill? So are we. That's why at least 90% of every new Peugeot is now recyclable, including the metal, glass, fluids, plastic materials and rubber. And we're well on the way to creating the fully recyclable car.

Which brings us back to the 308. It's the latest in our ever-increasing line of highly fuel-efficient cars. Like every other Peugeot being built today, its petrol engines are already set up to run on a mix of 10% bioethanol.



ENVIRONMENT

It's not just the engines themselves that we've been busy refining either. More aerodynamic cars need less fuel to get moving, which in turn means they produce less pollution (a 10% improvement in aerodynamics ultimately results in a 2.5% drop in CO₂ emissions). Which is why we've designed the 308 to be as sleek and streamlined as possible, reducing its drag co-efficient to just 0.29.

We may not be able to repair the damage that mankind has already done to the environment, but we are committed to doing everything we can to produce vehicles that work with it, rather than against. Are you with us too?

Fuel consumption (litres /100km)				CO ₂ (g/km)
Engines	City	Highway	Combined	Combined
1.6 (man / auto)	9.3 / 10.3	5.2 / 5.7	6.7 / 7.3	159 / 174
1.6 turbo (man / auto)	9.8 / 11.4	5.6 / 6.0	7.1 / 7.9	167 / 188
1.6 HDi (man / EGC)	6.6 / 5.9	4.2 / 4.1	5.1 / 4.7	134 / 125
2.0 HDi (man / auto)	7.2 / 9.4	4.5 / 5.3	5.5 / 6.8	144 / 180

FAP

Every diesel engine generates particles. At Peugeot, we should know because we pioneered the use of particulate filters (FAP) in our diesels. These filters reduce harmful emissions to barely measurable levels, helping to preserve the environment without spoiling the performance of your 308.

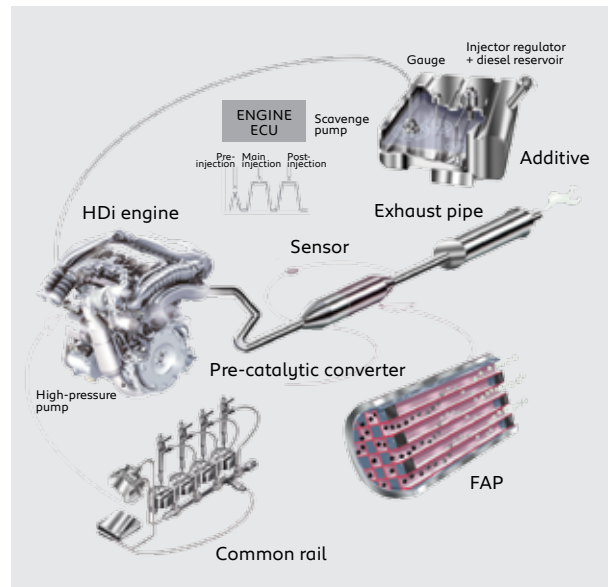

PERFECT PEACE OF MIND



AN ENTERTAINING RIDE IS A SAFE RIDE

At Peugeot, we don't believe you should have to take risks to have fun on the road. That's why we've spent thousands of hours developing, testing and refining the 308 to ensure it can keep its composure on even the most demanding of roads.

Our engineers gave it a wide wheel track and redesigned, electro-pump steering along with MacPherson front suspension and steel rear axle with a deformable cross member. What does that mean on the road? Pick your favourite bends and put the 308 through its paces, you'll find it strikes the perfect balance between solid stability and extreme agility, even at speed. Driving in town? Then you'll find its variable, electric power-assisted steering makes it easy to park and manoeuvre in heavy traffic.

As you might expect, the 308 is also equipped with a powerful, durable braking system designed to help maintain the car's composure even in difficult situations. This includes:

Anti-lock brakes (ABS) to help you keep control of the steering and prevent the car from skidding under heavy braking.

Electronic Brake Force Distribution (EBFD) applies a different amount of braking force to individual wheels to keep the car stable – especially if you need to brake in a corner.

Emergency Brake Assist (EBA) Hit the brakes hard in a hurry and the system will come to your aid, applying maximum braking power in milliseconds to bring you to a halt quickly and safely. This system automatically activates the hazard lights to warn other motorists.

Electronic Stability Program (ESP) which is standard across the range comprises:

- **Traction Control (ASR)** activates the braking and engine management systems to prevent the driven wheels from spinning in slippery conditions.
- **Dynamic Stability Control (DSC)** continuously monitors and compares data from the steering wheel sensor and the yaw sensor to detect any under or oversteer, then uses the braking and engine management systems to keep you on course.

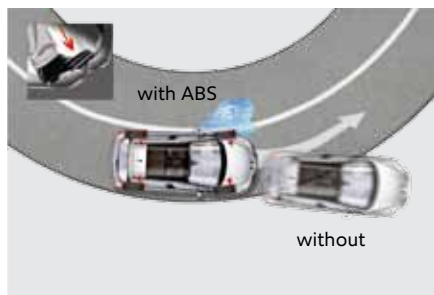

Anti-lock brakes (ABS)



Emergency Brake Assist (EBA)



Electronic Stability Program (ESP)



YOUR PERSONAL BODYGUARD

People come first with us. That's why we've taken all the features you can't see on the 308 as seriously as those you can.

Beneath its elegant, dynamic lines lies a passenger safety cell that's been designed with three impact absorption structures to soak up as much of the crash energy as possible if you're involved in an accident.

In the event of a head-on collision, you're protected by the main impact structure, as well as a new lower structure fitted onto the front subframe and extra reinforcements above the front wheel arches. So you and your passengers are effectively cocooned in a protective cell.

A further safeguard is provided by the 308's collapsible steering column which retracts to prevent excessive injuries to the driver.

The all-round protection continues with reinforced side panels to take the brunt of the force if you're hit from that angle, plus an aluminium alloy impact bar at the back to safeguard the cabin and the fuel tank.

If you do find yourself in a dangerous situation, it's reassuring to know that the 308 is fully equipped with 3-point seatbelts with force limiters, which complement the restraining effect provided by the pretensioner in the driver and front seat passenger's belts.

The 308's final line of defence is provided by six airbags.

- Two adaptive driver and front passenger airbags for head and upper body protection, which adapt their level of inflation to match the severity of the impact.
- Two front side airbags safeguard the driver and front passenger's chests and bodies.
- Two curtain airbags, to protect both the front and rear passengers' heads.

For when you have children on board the rear side seats are fitted with child seat mounting points so you can carry tiny VIPs safely and securely in compatible child seats.

Choose //

LEVELS



XS highlights

Exterior:

- 'Classic' grille
- Electrically operated door mirrors
- 15" steel wheels with 'Pacaya' wheel trims
- Body coloured door mirrors and handles

Interior:

- Electronic Stability Program (ESP)
- Aluminium style centre console
- Trip computer
- Front seat height adjustment
- 6 airbags
- Cruise control and speed limiter
- Air conditioning
- Front centre armrest with storage bin
- Height and reach adjustable steering wheel



'Sibayak' Black cloth (hatch)



'Kawana' Black cloth (Touring)



15" 'Pacaya' wheel trim (standard)



Additional Touring highlights:

- Panoramic glass roof
- Three independent and interchangeable 2nd row seats
- Individually reclining and sliding 2nd row seats
- Individually folding and removable 2nd row seats

Engines:

- 1.6 (Hatch only)
- 1.6 HDi diesel
- 2.0 HDi diesel (Touring only)



16" 'Tzalco' alloy wheels (optional)



Gear lever with Black surround



XSE highlights

XS features, plus:

Exterior:

- Body colour side rubbing strips
- 16" alloy wheels
- Rear parking assistance
- Automatic rain-sensing front wipers
- Automatic headlight illumination system

Interior:

- Leather steering wheel
- Rear centre armrest
- Lumbar support on front seats
- Dual Zone Climate Control



'Starting' Black cloth (hatch)



'Kawana' Black cloth (Touring)



16" 'Santaguito' alloy wheels (standard)



Engines:

- 1.6 turbo
- 1.6 HDi diesel (hatch only)
- 2.0 HDi diesel



17" 'Rinjani' alloy wheels (optional)



'Irazu' Beige cloth (hatch only)



Gear lever with 'Warm Silver' surround



XTE highlights

XSE features, plus:

Exterior:

- Panoramic glass roof
- Electric folding door mirrors
- Sports rear bumper
- 17" alloy wheels

Interior:

- Auto-dipping rear view mirror



'Starting' Black cloth



'Irazu' Beige cloth



17" 'Rinjani' alloy wheels (standard)



Engines:

- 1.6 turbo
- 2.0 HDi diesel



18" 'Lincancabur' alloy wheels (optional)



'Square' trim decor



Gear lever with 'Square' surround

Leather trim (optional)



Black leather – optional on XSE and XTE



Beige leather – optional on XSE and XTE

Dimensions



4276 mm

1498 mm



2038 mm

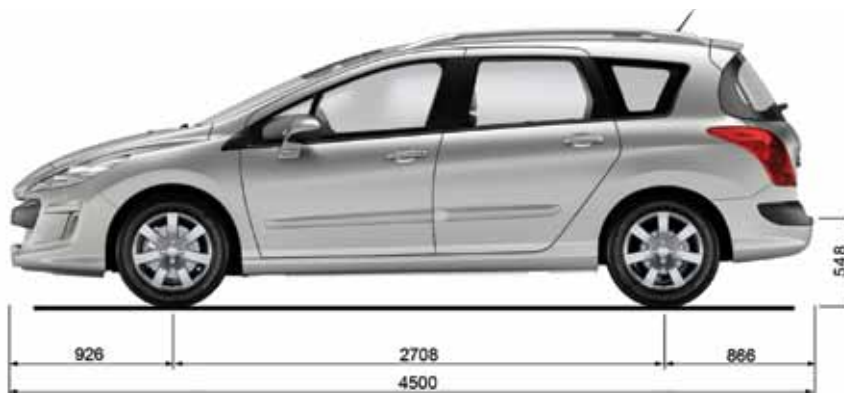

926

2708

886

4500

548

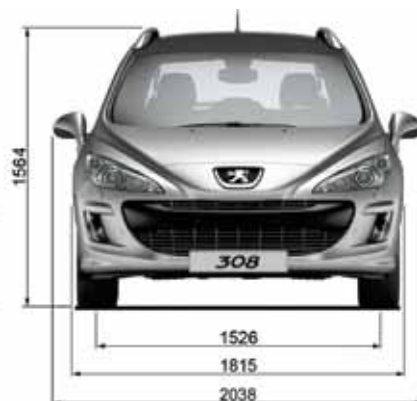

1564

1526

1815

2038

PEACE OF MIND

When you choose Peugeot, you have the reassurance of knowing that your vehicle has been designed and manufactured to give you years of worry-free motoring. Our commitment to you continues after purchase and is embodied in the Peugeot AfterCare program. You can rest assured that everything you'll ever need for your vehicle is covered, from accessories and servicing to parts and warranty. The Peugeot Assistance card you are given with your new vehicle is a key part of AfterCare, as is the reassurance of having a dedicated network of dealers Australia-wide with specialist factory trained technicians to look after you and your vehicle. AfterCare demonstrates that we care for your Peugeot as much as you do, and ensures the quality of your ownership experience lasts long after you've left the showroom.

Driving down the costs of servicing

Peugeot petrol and diesel engine cars need servicing every 20,000 kms or every 12 months, whichever is the sooner. This reflects a recent lengthening of the schedule and with less time spent in the maintenance bay and fewer service visits, Peugeot has passed on the benefits of technology in engine design and lubrication. While Peugeot can predict the maintenance needs of engine and other major components, the wearing of certain components such as tyres and brake pads is less predictable and is affected by driving style and conditions.

3 year /100,000 km warranty

Should any part of the vehicle require repair or replacement as a result of a manufacturing or material defect within the warranty period, the part will be repaired or replaced completely free of charge by your authorised Peugeot dealer, regardless of any change of ownership during the period covered. The warranty does not cover items replaced during normal service

and maintenance operations, which are subject to wear and tear. During the period you will also automatically receive Peugeot Assistance cover for complete peace of mind (subject to the conditions outlined in the Warranty Maintenance Book).

12 year anti-corrosion warranty

Peugeots are renowned for their durability and longevity. This is due in part to the sophisticated measures which are taken during the production process to optimise long-term protection from the elements. Peugeot backs this advanced technology with a 12 year warranty against corrosion-perforation of your car's bodywork – one of the longest body warranties in the world today (subject to conditions in the Warranty Maintenance Book).

Peugeot Assistance

Whatever it takes to get you going again, in the unlikely event of a breakdown or emergency, it only takes one free phone call. Peugeot Assistance is free for Peugeot new car owners.

The programme includes 24-hour roadside assistance, vehicle recovery, technical advice, message service, home assistance and accident or theft co-ordination. Your Peugeot Dealer has full details of all terms and conditions.

Peugeot genuine parts promise

If your car is in for a service or repair, the parts required to keep your car on the road are Peugeot genuine parts. Using specifically designed and manufactured parts ensures your Peugeot can operate at peak performance at all times.

Important notice

Peugeot Automobiles Australia offers this brochure as a general guide to product specifications. Photographs and illustrations in this brochure are for illustrative purposes only and do not necessarily represent final production models for Australia, or modifications made to meet Australian standards or requirements. All data in this brochure is believed to be correct as at March 2010. However, as development is an ongoing

process, changes may occur from time to time which will not necessarily be reflected herein. Therefore, Peugeot Automobiles Australia reserves the right to change specifications without notice. Accordingly, this brochure should not be regarded as an infallible guide to correct specifications, nor does it constitute an offer for sale of any particular vehicle. Dealers are not agents of Peugeot Automobiles Australia and have absolutely no authority to bind Peugeot Automobiles Australia by an express or implied undertaking or representation. Peugeot Automobiles Australia is the trading name of Sime Darby Automobiles Pty Limited (ACN 000 426 282).

For full specifications details

visit peugeot.com.au
Peugeot Automobiles Australia
Locked Bag 206,
Silverwater NSW 1811.

