



308



PEUGEOT



THE RIGHT CHEMISTRY

WHEN YOU CHOOSE A PEUGEOT, YOU'RE BUYING MORE THAN AN ELEGANT PIECE OF DESIGN OR A SUPERB PIECE OF ENGINEERING, YOU'RE BUYING A VISION – OUR DREAM OF A MARQUE THAT EMBODIES YOUR DESIRES AND MEETS YOUR EXPECTATIONS IN EVERY WAY. A VEHICLE THAT IS THE VERY PERSONIFICATION OF THE PEUGEOT SPIRIT.

This spirit, or essence, of our marque can be summed up in four words. Style, quality, dynamism and innovation – the values that every Peugeot is created around. So what does that mean to you? It means beauty, stunning design, pure Peugeot lines, the very quintessence of aesthetics as seen by top Peugeot designers.

Or roughly translated, a car that makes your heart beat faster every time you look at it.

It means a car that you can trust. Every new Peugeot is engineered to the very highest standards to achieve optimum active and passive safety, ensuring technical excellence, superb handling plus peace of mind.

It also means passion. Our passion for creating cars with real poise and precision, cars that communicate with the road and connect with you, lifting your spirits on every journey. Cars that re-awaken your enthusiasm for driving.

It goes without saying that it means intelligent, innovative designs and features that answer your demands for better, safer, more comfortable and environmentally respectful vehicles. We've reduced emissions from our engines and every new car we build is at least 90% recyclable.

These are the strands of Peugeot DNA that you'll find running through every vehicle that bears our name today, and every car that we'll build tomorrow. Creating the perfect chemistry between you and your car.

308



THE ART OF COMPLETENESS

How can you tell when you've achieved design excellence? When you've refined every detail until you can't improve it any further? When all the individual components come together to make one, beautifully balanced whole, just as they do in the Peugeot 308? One look at its sleek V-shaped bonnet, the wide, cat-like headlights, the distinctive front grille with its aerodynamic louvres and the deeply recessed fog lights, and you don't have to be told that, in its class, this car sets a new benchmark. You just know.





PERFECTLY POISED

Even at a standstill, the 308 looks poised, ready for action. Its perfect balance of height and length, combined with a commanding, wide track give it a purposeful stance. The taut body line running the length of its side from the rear shoulder to the front wheel arches gives it a feeling of momentum. The pronounced, flat wheel arches and the large wheels hint at the dynamic performance to come.

While from the rear, the wrap-around window and muscular sports bumper simply confirm its intentions. If you like what you see on the surface of the 308, you'll be even more impressed when you discover what lies beneath.

ENDLESS POSSIBILITIES



The spacious new 308 Touring is versatile in more ways than one. Not only is it more powerful than its predecessors, it's also stronger, lower and wider with the ability to accommodate up to seven passengers.* The fact

that you can rearrange the rear seating into over 50 different seating configurations means it fits perfectly with any lifestyle. So revolutionary is the 308 Touring's modular interior that it won an Australian International



Design Award (Automotive & Transport category) for design excellence. The body has also been designed to reflect the car's versatility, by combining a particularly expressive and dynamic design at the front

with an original and curvaceous shape at the rear.

A sloping design adds elegance whilst flowing lines reinforce the impression of space and on-board comfort.



LET THE LIGHT SHINE

Beyond that, the 308 Touring boasts some very practical features such as a panoramic glass roof and wrap-around rear windscreen which all aim to increase natural light and enhance your driving experience.

*6th and 7th seats optional at extra cost.

THOROUGHNESS – DOWN TO THE LAST DETAIL



When we designed the interior of the 308, we wanted it to provide truly superior comfort. So one of our top priorities was to make sure that everyone had plenty of space to stretch out. Part of our solution was to angle the dashboard by

30 degrees, freeing up space around the driver's and front seat passenger's knees. We also gave them comfortable yet slim-backed sports seats, which created a few valuable extra inches of leg room for the rear passengers.

But we didn't stop at giving the 308 more cabin space. To boost comfort levels even higher, we raised the back seats – treating occupants to improved visibility.

And just to make the car feel

really spacious and airy we designed in a huge panoramic rear window.

More clever thinking went into ensuring that the interior of the 308 was a really calm place to be. We built in high levels



of sound insulation. We fitted a photosensitive rear-view mirror* to prevent the driver from being dazzled by the car behind.

The little things were big priorities too. Like making sure

that there were plenty of places to stow away all your family's bits and pieces.

We didn't want you to be left in the dark when light levels started to fall either. That's why you'll find courtesy lights in the

front and centre of the roof, as well as in the boot.

So, did we succeed in making the 308 one of the most comfortable places to be on the road? Well, we can honestly say we think you'll

be impressed. Part of the 308's beauty is in the details.

Evidence of our commitment to quality can be found in features like the specially woven seat trim.

*Depending on model variant.

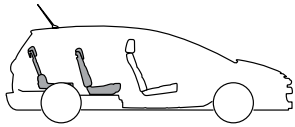

Seating

- 5 seats or up to 7 seats available as an option
- Seat backrests recline from 19 to 30° in seat row 2
- Second seat row comprising 3 individual sliding seats over a length of 90mm

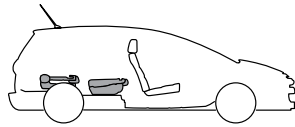

Seat shelf position

- The backrest can be folded down against the seat cushion to form a carpeted shelf
- The centre seat in the second seat row, once the backrest is folded can be used as a table/shelf

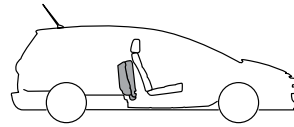

Seats folded position

- Improved load volume when the seats in the second or third seat row are folded down

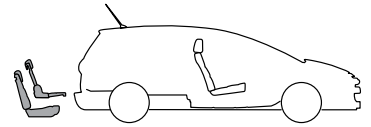

Seats removed

- Option of retaining only the driver and front passenger seats
- Optimised load volume



CREATE YOUR OWN SPACE: 308 TOURING

The 308 Touring was designed to allow you to create the environment you want. This is done by giving you the ability to literally re-sculpture the inside of your car to fit your personal lifestyle requirements. The three seats in the 2nd row are independent and interchangeable, and can slide, fold away, be removed completely or even placed in the 3rd row. You also have the option of two independent, foldable and removable 3rd row seats* – perfect for when you have unexpected company. And you will still have room for additional luggage thanks to its extremely generous boot size.

The 2nd row seats also have the advantage of being able to slide over a distance of 90mm, increasing rear leg room or creating extra space in the load area which is handy when transporting extra bulky items.

*6th and 7th seats optional at extra cost.



CARRYING CAPACITY, PURE AND EASY: 308 WAGON

If you prefer a more conventional 5-seat wagon configuration, then the 308 Wagon is for you. With a fixed 2nd row rear seat offering the benefits of a 60:40 split-folding function, the Wagon maximises the functionality of the rear cargo area without compromising 308's enviable reputation for comfort and refinement.

From furniture shopping to bike riding to weekends away with the family, the 308 Wagon has been designed to do what you need it to do. Quickly, and easily. So you can relax, sit back and enjoy the ride.





SEE DRIVING IN A NEW LIGHT



Getting into the 308 for the first time is a very enlightening experience.

Not content with giving the 308 the largest expanse of window glass in its class (3.6m²), for a virtually unobscured view of the road, we've also given it a huge, panoramic glass roof* which lets light flood in from outside to give you an amazing sense of freedom and space. This increases the glass area to an incredible 4.8m² (Hatch) or 5.58m² (Touring). Stretching an incredible 1.26m (1.68m for Touring), the roof effectively extends the stylishly raked windscreen right to the back of the passenger compartment, brightening up everyone's journey.

Worried about your passengers getting too much sunshine? Don't be. The heat reflective, tinted glass has been treated to filter out 80% of the sun's ultraviolet rays.

And if the sun really starts to shine down, an electric sunblind is ready to cover up all or part of the roof at the touch of a button. There's even a thoughtful anti-pinch system to stop it operating if little fingers get in the way. Yes, the 308 could seriously change your outlook on driving.

Settle down in the driving seat of the 308 and you know you're on the road to the perfect driving experience.

*Standard on Allure Hatch and all Touring models. Optional depending on model variant.

SETTLE DOWN IN THE DRIVING SEAT OF THE 308 AND YOU KNOW YOU'RE ON THE ROAD TO THE PERFECT DRIVING EXPERIENCE.

THE PERFECT DRIVING PARTNER

As if our knowledge and experience plus our passion for developing drivers' cars weren't invitation enough, the 308's rigid chassis, low centre of gravity and wide track positively beg you to put its outstanding driving dynamics to the test.

Braking hard into a corner? You'll be pleased to know that the 308's brakes are the best in its class, featuring extra large ventilated discs on the front for more bite and endurance without a hint of vibration.

Storm clouds looming? The 308's already ahead of you. As soon as the first drops hit, the intelligent sensor* at the top of the windscreen will activate the wipers, which speed up to match the intensity of the rain. And if the light levels start to fall too, the same sensor will turn on the headlights for you.

The 308 can also see you safely to and from your door at night. The headlights stay on to light your way for a few seconds after you've used the plip key to lock the car.

Equally important, the 308 can take care of itself. The fuel filler cap can only be opened with a key, and it has a coded anti-start device to discourage unwanted admirers.

*Depending on model variant.

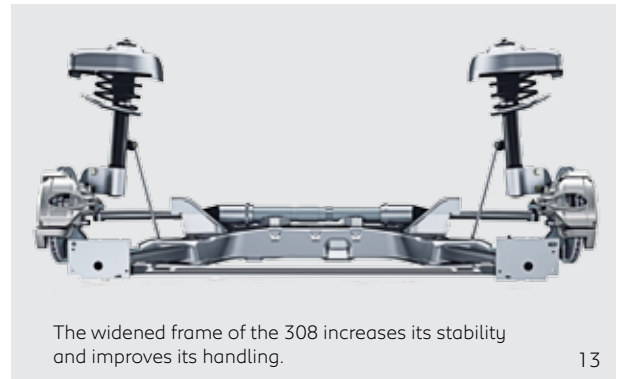

The widened frame of the 308 increases its stability and improves its handling.



ENGINES

PETROL

1.4L 16-valve 72kW & 136Nm

1.6L 16-valve 88kW & 160Nm

1.6L turbo 16-valve 115kW & 240Nm

Each of the three petrol engines available in the 308 range has been designed to deliver maximum performance along with optimised fuel efficiency for its cubic capacity. All offer the benefits of variable valve timing for immediate throttle response at all speeds and in all situations.

DIESEL

2.0L 16-valve HDi FAP 110/120kW & 340Nm

This advanced turbo diesel engine is coupled with either a 6-speed manual or 6-speed automatic transmission and delivers effortless performance and dynamism to make driving a pleasure. Fitted with Peugeot's revolutionary Particle Emission Filter (FAP) system, it is also exceptionally clean and complies with the tough Euro 5 emissions control standards.

STOP & START Diesel

1.6L e-HDi FAP 82kW & 270Nm
Micro-Hybrid technology

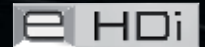

Protecting the future of the planet is one of the greatest challenges facing us. Peugeot has set out to meet this challenge with the introduction of e-HDi technology on the 308 range. Incorporating a host of technical innovations and utilising learnings from Peugeot hybrid research, this STOP & START system automatically cuts the engine each time the vehicle comes to a stop (such as at traffic lights or in heavy traffic). The new feature of this system is that the engine restarts very quickly and smoothly when the driver wants to continue. Consequently, the e-HDi offers improved control of fuel consumption and CO₂ emissions.

Gains in fuel efficiency for the e-HDi engine in congested urban areas are approximately 15% compared with a conventional vehicle, subject to driving style and other conditions.

PEUGEOT AND THE ENVIRONMENT

Peugeot offers an extensive range of low emission vehicles – more than half of its worldwide sales are of vehicles producing less than 140g of CO₂ per km. Peugeot is the leader in a range of proven technologies designed to improve environmental performance. For example, the diesel engine combined with particle emission filter (FAP), results in a 99.99% reduction of particle emissions. Launched in 2000, this technology is now fitted in more than 2.1 million vehicles. Peugeot's breakthrough technology includes integration of the Stop & Start system and the development of a new generation of HDi engines.

HDi FAP

A high-performance emission control system, the Particle Emission Filter (FAP) is combined with HDi technology. A self-cleaning system, it treats the gas resulting from the combustion of the diesel in the engine. The filter contributes to reducing the diesel particles, bringing them to the measurable limit (0.004g/km). The simple end result is a cleaner diesel engine.



CLEANER EMISSIONS

All engines in the 308 range – petrol and HDi – feature advanced technology which allows them to meet and exceed the stringent Euro 5 emissions standard. Euro 5 is the toughest standard in force in Europe today, and easily exceeds the Euro 4 level which has been required by Australian law since July 2010.

PERFECT PEACE OF MIND

At Peugeot, we don't believe you should have to take risks to have fun on the road. That's why we've spent thousands of hours developing, testing and refining the 308 to ensure it can keep its composure on even the most demanding of roads.

Our engineers gave it a wide wheel track and redesigned, electro-pump steering along with MacPherson front suspension and steel rear axle with a deformable cross-member. What does that mean on the road? Pick your favourite bends and put the 308 through its paces, you'll find it strikes the perfect balance between solid

stability and extreme agility, even at speed.

Driving in town? Then you'll find its variable, electric power-assisted steering makes it easy to park and manoeuvre in heavy traffic. As you might expect, the 308 is also equipped with a powerful, durable braking system designed to help maintain the car's composure even in difficult situations. This includes:

Anti-lock brakes (ABS) to help you keep control of the steering and prevent the car from skidding under heavy braking.

Electronic Brake force Distribution (EBD) applies a different amount of braking force to individual wheels to keep the car stable – especially if you need to brake in a corner.

Emergency Brake Assist (EBA)
Hit the brakes hard in a hurry and the system will come to your aid, applying maximum braking power in milliseconds to bring you to a halt quickly and safely.

This system automatically activates the hazard lights to warn other motorists.

Electronic Stability Program (ESP) which is standard across the range comprises:

- **Traction Control (ASR)** activates the braking and engine management systems to prevent the driven wheels from spinning in slippery conditions.
- **Dynamic Stability Control (DSC)** continuously monitors and compares data from the steering wheel sensor and the yaw sensor to detect any under or oversteer, then uses the braking and engine management systems to keep you on course.



YOUR PERSONAL BODYGUARD

People come first with us. That's why we've taken all the features you can't see on the 308 as seriously as those you can. Beneath its elegant, dynamic lines lies a passenger safety cell that's been designed with three impact absorption structures to soak up as much of the crash energy as possible if you're involved in an accident. In the event of a head-on collision, you're protected by the main impact structure, as well as a new lower structure fitted onto the front subframe and extra reinforcements above the front wheel arches. So you and your passengers are effectively cocooned in a protective cell.

A further safeguard is provided by the 308's collapsible steering column which retracts to prevent excessive injuries to the driver. The all-round protection continues with reinforced side panels to take the brunt of the force if you're hit from that angle, plus an aluminium alloy impact bar at the back to safeguard the cabin and the fuel tank.

If you do find yourself in a dangerous situation, it's reassuring to know that the 308 is fully equipped with 3-point seatbelts with force limiters, which complement the restraining effect provided by the

pretensioner in the driver and front seat passenger's belts.

The 308's final line of defence is provided by six airbags.

- Two adaptive driver and front passenger airbags for head and upper body protection, which adapt their level of inflation to match the severity of the impact.
- Two front side airbags safeguard the driver and front passenger's chests and bodies.
- Two curtain airbags, to protect both the front and rear passengers' heads.

For when you have children on board the rear seats are fitted with child seat mounting points so you can carry tiny VIPs safely and securely in compatible child seats.

In 2009, the Peugeot 308 hatch successfully repeated the Euro NCAP* ADULT OCCUPANT PROTECTION test, obtaining once again 5 stars (i.e.; the "excellent" level), the maximum that can be obtained. Created in 1997, the Euro NCAP is an independent European organisation that evaluates the safety of vehicles available on the market by means of several tests: front impact, side impact, pillar test, etc. The organisation makes the results of these tests public using a star rating system.

*European New Car Assessment Program.



Leather trim (optional)



Black leather – optional on Active and Allure variants.



Beige leather – optional on Active and Allure variants.

Black leather – optional on Active and Allure variants.

Dimensions

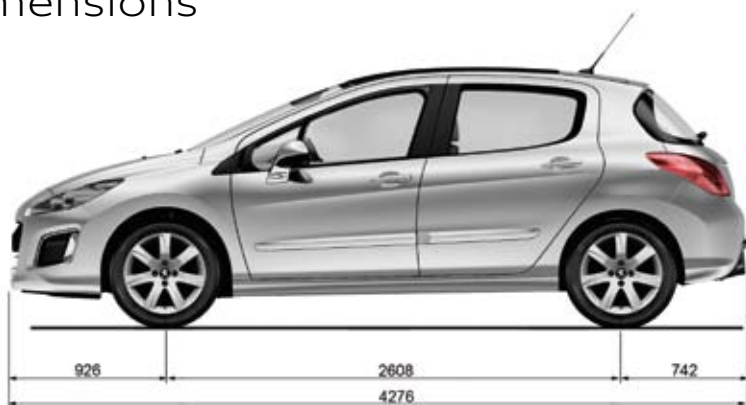

1408

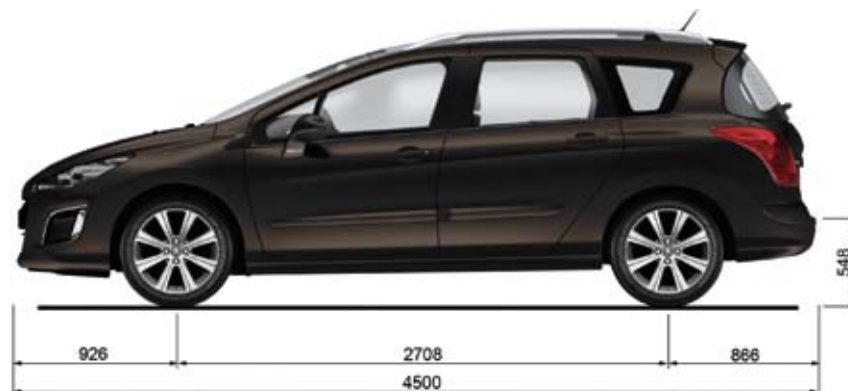

548



PEUGEOT AND YOU

When it comes to peace-of-mind servicing for your new 308 there is no substitute for certainty. Therefore every new 308 includes our innovative new Assured Service Plan, which provides you with a set price for each of the first three scheduled service operations (every 12 months or 20,000km, whichever occurs first). Ask your Peugeot dealer for more details.

AFTERCare
A S S U R E D
S E R V I C E P L A N

DRIVING DOWN THE COSTS OF SERVICING

Peugeot petrol and diesel engine cars need servicing every 20,000km or every 12 months, whichever is the sooner. This reflects a recent lengthening of the schedule and, with less time spent in the maintenance bay and fewer service visits, Peugeot has passed on the benefits of technology in engine design and lubrication. While Peugeot can predict the maintenance needs of engine and other major components, the wearing of certain components such as tyres and brake pads is less predictable and is affected by driving style and conditions.

3 YEAR / 100,000 KM WARRANTY

Should any part of the vehicle require repair or replacement as a result of a manufacturing or material defect within the warranty period, the part will be repaired or replaced completely free of charge by your authorised Peugeot dealer, regardless of any change of ownership during the period covered. The warranty does not cover items replaced during normal service and maintenance operations, which are subject to wear and tear. During the period

you will also automatically receive Peugeot Assistance cover for complete peace of mind (subject to the conditions outlined in the Warranty Maintenance Book).

12 YEAR ANTI-CORROSION WARRANTY

Peugeots are renowned for their durability and longevity. This is due in part to the sophisticated measures which are taken during the production process to optimise long-term protection from the elements. Peugeot backs this advanced technology with a 12 year warranty against corrosion-perforation of your car's bodywork – one of the longest body warranties in the world today (subject to conditions in the Warranty Maintenance Book).

PEUGEOT ASSISTANCE

Whatever it takes to get you going again, in the unlikely event of a breakdown or emergency, it only takes one free phone call. Peugeot Assistance is free for Peugeot new car owners. The programme includes 24-hour roadside assistance, vehicle recovery, technical advice, message service, home assistance and accident or theft co-ordination.

Your Peugeot dealer has full details of all terms and conditions.

PEUGEOT GENUINE PARTS PROMISE

If your car is in for a service or repair, the parts required to keep your car on the road are Peugeot genuine parts. Using specifically designed and manufactured parts ensures your Peugeot can operate at peak performance at all times.

IMPORTANT NOTICE

Peugeot Automobiles Australia offers this brochure as a general guide to product specifications. Photographs and illustrations in this brochure are for illustrative purposes only and do not necessarily represent final production models for Australia, or modifications made to meet Australian standards or requirements. All data in this brochure is believed to be correct as at August 2011. However, as development is an ongoing process, changes may occur from time to time which will not necessarily be reflected herein. Therefore, Peugeot Automobiles Australia reserves the right to change specifications without notice. Accordingly, this brochure should not be regarded as an infallible guide to correct

specifications, nor does it constitute an offer for sale of any particular vehicle.

Whilst all care has been taken to provide any purchaser or prospective purchaser information in regards to the general use of Peugeot products, purchasers should not rely solely on the information provided in this brochure. Purchasers or prospective purchasers should discuss individual intended purposes or use of Peugeot products with your Peugeot dealer before making a purchase decision. Peugeot dealers are not agents of Peugeot Automobiles Australia and have absolutely no authority to bind Peugeot Automobiles Australia by an express or implied undertaking or representation. Peugeot Automobiles Australia is the trading name of Sime Darby Automobiles Pty Limited (ACN 000 426 282).

FOR FULL SPECIFICATIONS DETAILS visit peugeot.com.au
Peugeot Automobiles Australia
Locked Bag 206,
Silverwater NSW 1811

AFTERCare

