

This brochure has been compiled by DaimlerChrysler AG of Germany and is distributed internationally. It provides a general indication of the range of models, features, optional extras and/or colours available in various countries. Some of the models, features, optional extras and/or colours shown may not be available in your country or may only be available in a different specification. Additionally some models, features, optional extras and/or colours may only be available in combination with others. For current and more specific information in relation to the range of models, features, optional extras and/or colours available in your country, and their pricing, you should contact your nearest authorised Mercedes-Benz Passenger Car Dealer.



Mercedes-Benz



## THE C-CLASS ESTATES



Mercedes-Benz



Fit in every discipline. The C-Class Estates









## Contents

|    |                          |
|----|--------------------------|
| 04 | The C-Class Estates      |
| 08 | Drive system             |
| 12 | DIRECT CONTROL           |
| 18 | Comfort                  |
| 26 | Load compartment         |
| 30 | Safety                   |
| 36 | Equipment                |
| 40 | AMG                      |
| 42 | Sports packages          |
| 46 | designo                  |
| 48 | Optional extras          |
| 52 | Accessories              |
| 54 | Paintwork and upholstery |
| 58 | Technical data           |
| 60 | Dimensions               |
| 62 | Glossary                 |

## The honed looks of a true athlete

Design, performance, spaciousness – the toned and muscular C-Class Estates score highly in every category. The Estate's sporty nature is written on its face, its shining eyes taking the form of high-gloss, clear-lens headlamps. The three-louvre radiator grille and the front apron, with its large air intakes, create a powerful look. And the front end is equally impressive when it comes to safety: the bumpers feature integral fog lamps which, in conjunction with the optional bi-xenon headlamps, are automatically activated on cornering, lighting up the inside of the corner to best effect.

The side skirts, the rear bumpers and the tail lights, with their dark red, high-gloss design, complete the Estate's sporty guise. But enough of its looks. Its performance is equally eye-catching, thanks to the new 6-cylinder engines, which offer enhanced power, refinement and fuel-efficiency. The high-precision DIRECT CONTROL suspension ensures agile handling, and the 6-speed DIRECT CONTROL transmission delivers fast, sporty gear changes – as you would expect of a true athlete.

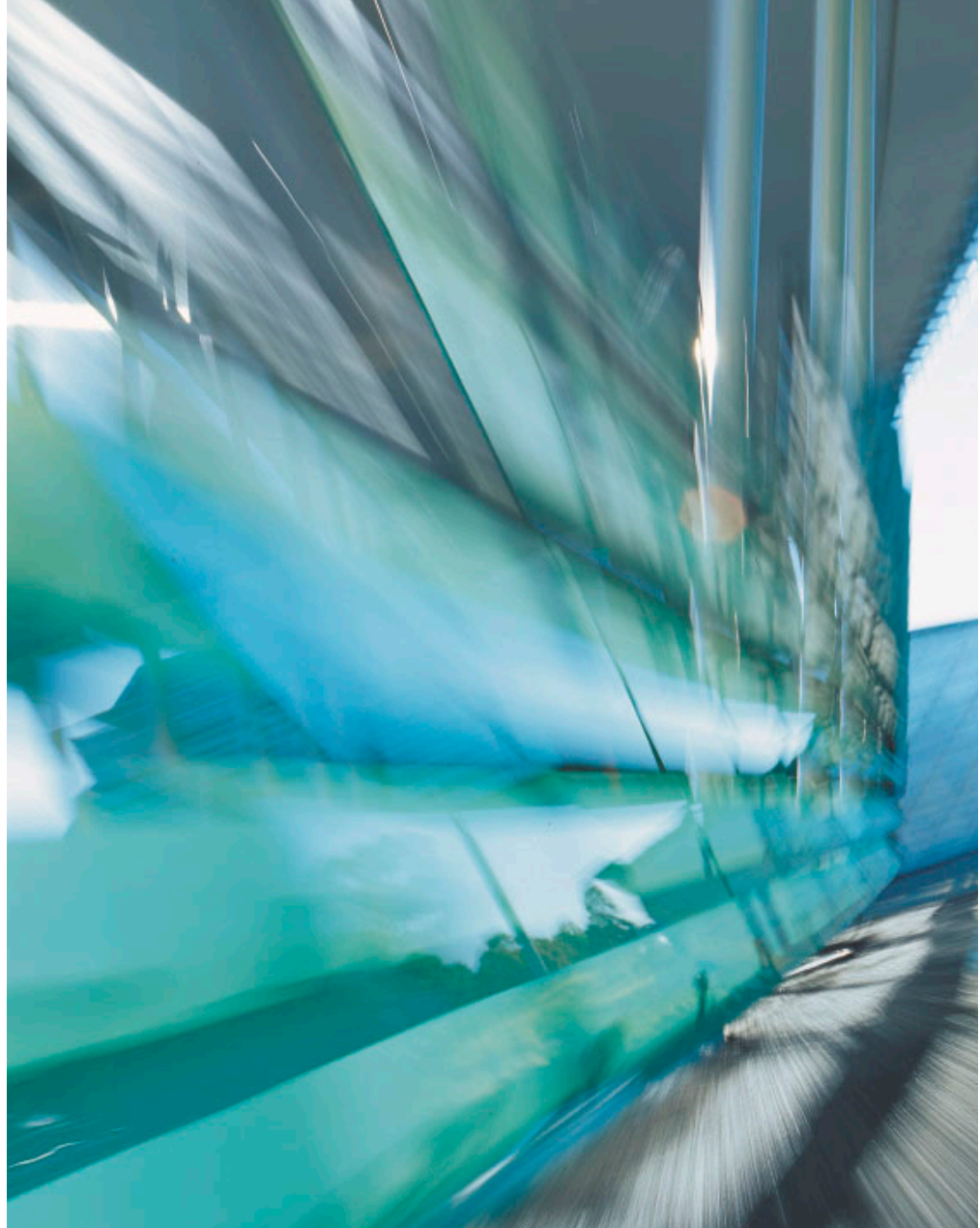











*The interior of the C-Class Estate is worthy of a gold medal. Only the finest materials have been used – and attention to detail is evident wherever you turn, from the ergonomic form of the selector lever to the instrument cluster, with its 4-tube, chrome-ringed design. Optional leather upholstery adds a further refined touch*



## Top performance under pressure

The CDI diesel engines in the C-Class Estate deliver sterling performance every step of the way. With common-rail direct injection, precisely metered quantities of fuel are injected into the combustion chambers at a pressure of up to 1600 bar – something that those on board experience in these models' tremendous tractive power, even in the lower engine speed range. While impressing the Estate's occupants, the CDI engines, thankfully, make somewhat less of an impact on the environment. They are fitted as standard with a particulate filter which minimises emissions.

Other typical features of CDI are low fuel consumption and a reticence when it comes to noise and engine vibration. That's something that applies equally to the C 200 CDI with its 90-kW (122-hp) output, to the C 220 CDI with 110 kW (150 hp) and, of course, to the C 320 CDI, with 165 kW (224 hp). The maximum torque for these engines ranges from 270 Nm to 415 Nm. The C 320 CDI is available with the 7G-TRONIC 7-speed automatic transmission as an optional extra, which means that it has an impressive 510 Nm of torque on tap.







## Quick out of the blocks in sprints, big on stamina for longer distances

With the new generation of 6-cylinder engines in the C 230, C 280 and C 350, the C-Class Estates now have even more of a leading edge – whether they're judged on performance, with up to 200 kW/ 272 hp and 350 Nm on tap, on smoothness, where the balancer shaft and adept mixture formation play a key role, or on economy and environmental compatibility, with optimised fuel combustion. The C 280 and C 350 are also available as 4MATIC models with permanent all-wheel drive.

Thanks to the TWINPULSE system, the 4-cylinder supercharged engines in the C 180 KOMPRESSOR and C 200 KOMPRESSOR deliver driving pleasure and comfort in abundance – and they're impressively economical too.

The crowning glory of the C-Class engine range is the C 55 AMG, with its 5.5-litre V8-engine and 270-kW/367-hp output. While offering the spaciousness and comfort of an Estate, the C 55 AMG performs like a sports car, accelerating from 0 to 100 km/h in just 5.4 seconds.

*C 350 AVANTGARDE with sports package*

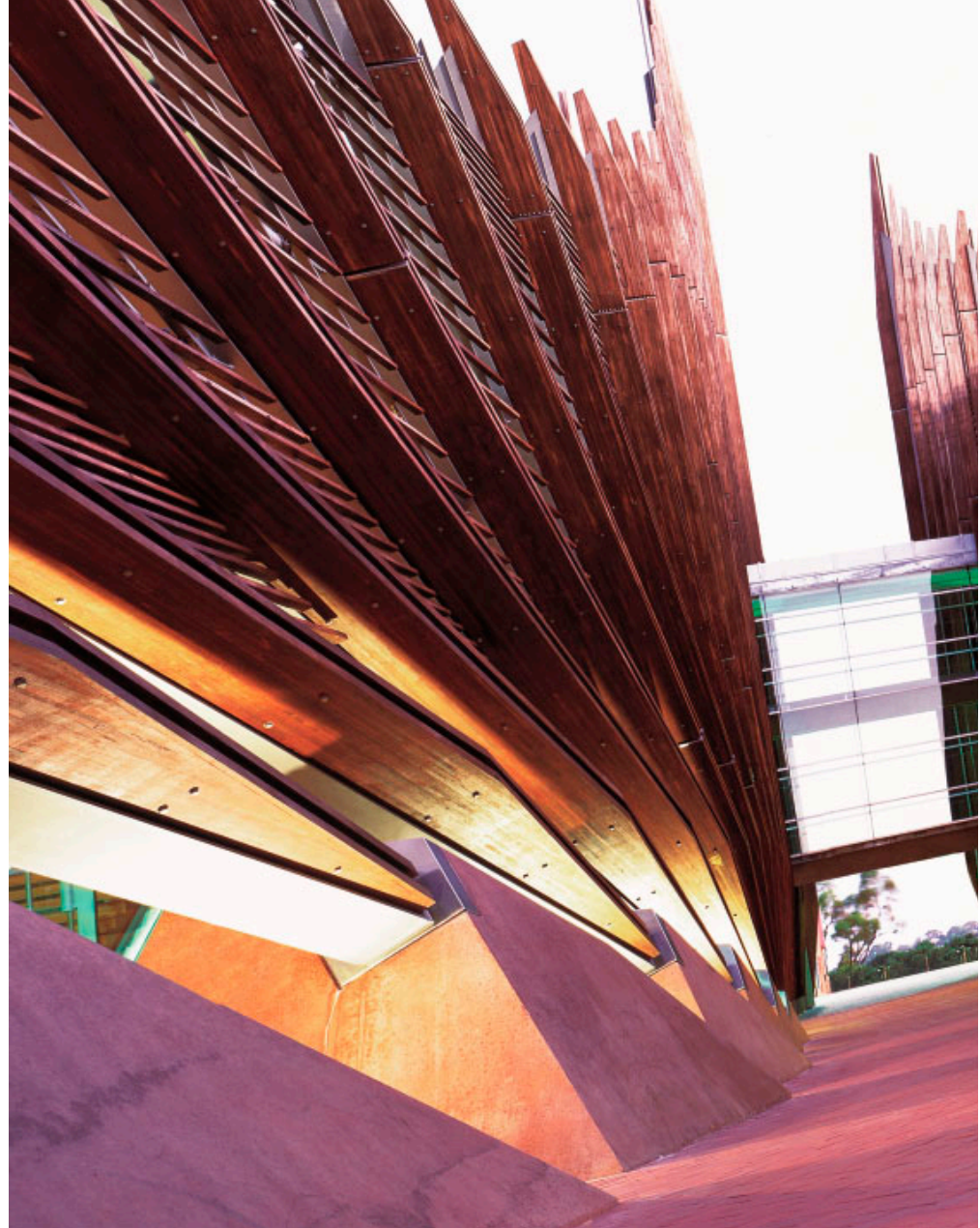







## Sports highlights never fail to raise a smile

There's no stopping it now: the C-Class Estate has, after all, been subjected to no-nonsense agility testing – and has passed with flying colours, combining impressive dynamic handling with top-class comfort.

The key to this driving sensation is DIRECT CONTROL: the suspension tuning and the direct steering lead to significantly enhanced driving pleasure. And the DIRECT CONTROL gearshift, with its short shift travel, makes for even faster gear changes.

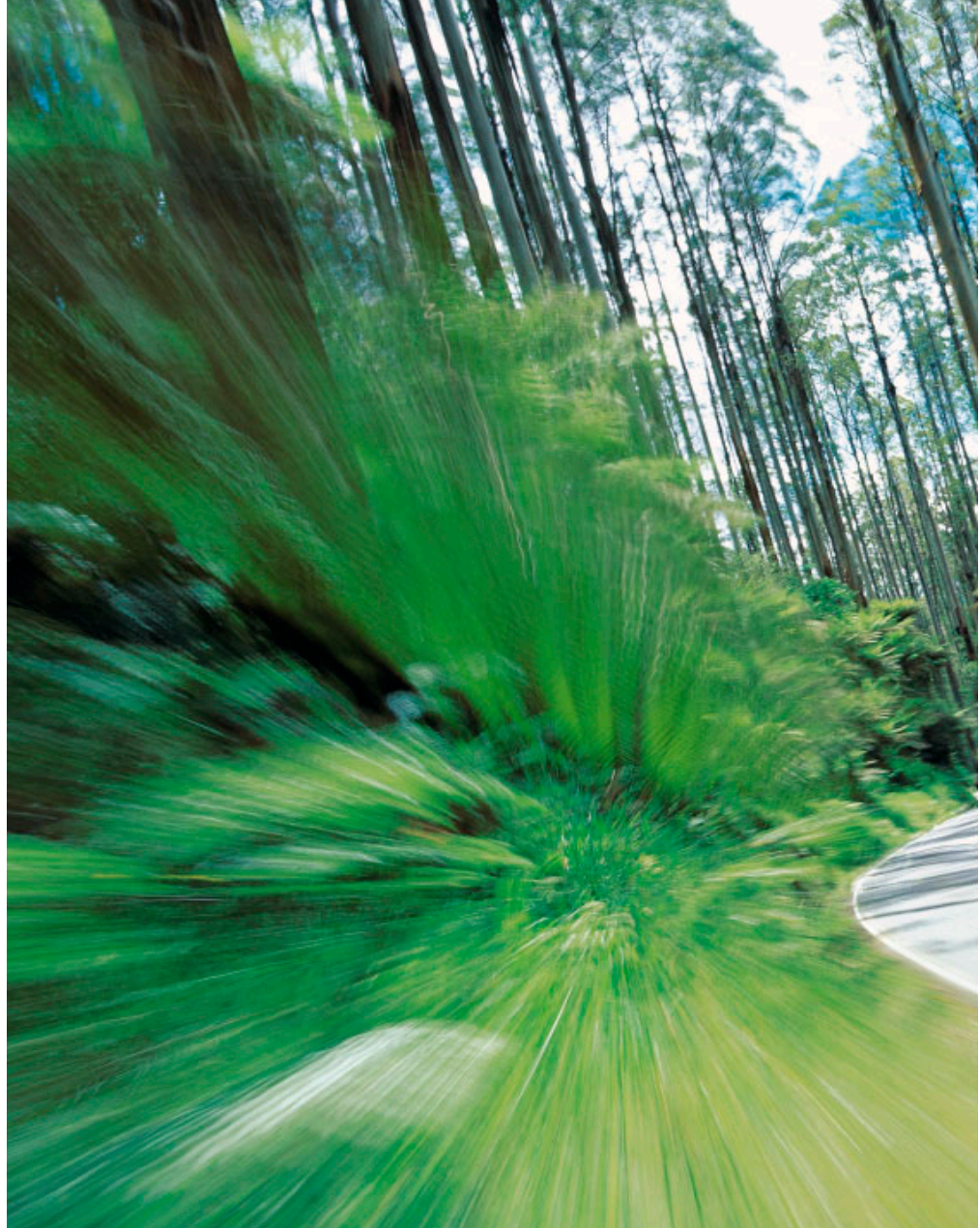







*C 350 AVANTGARDE with sports package*















C 350 AVANTGARDE with sports package

*4MATIC permanent all-wheel drive rounds off the sporty dream team to perfection. Its impressive stability and traction are supported by the 4ETS traction system. Stepping in at the first sign that one or more of the driven wheels is starting to spin, its precisely metered brake intervention produces the same effect as up to three conventional differential locks, which in practical terms makes for a spectacularly enjoyable drive. Even in the wet, or on snow, slush or ice, 4MATIC demonstrates its strengths impressively*



## A personality that eclipses competition

The C-Class Estate makes a dazzling impression. That's partly down to the more scratch-resistant clearcoat. This world first from Mercedes-Benz is significantly tougher than conventional paint, ensuring more intensive gloss over an extended period of time. External appearances give you a good idea of what you can expect inside – where several highlights await.

You can use the buttons on the multifunction steering wheel to operate the CD player, or even your iPod® in conjunction with the iPod® Interface Kit, available as part of the accessories range – and all without taking your hands off the steering wheel. The optional COMAND APS control and display system acts as your C-Class Estate's control centre.

THERMOTRONIC, the luxury climate control system, available as an optional extra, ensures a pleasant on-board atmosphere, allowing even more individual temperature regulation. Residual heat control is also available. And the optional PARKTRONIC system enables you to keep your cool when parking by recognising how far away you are from any obstacle and emitting an audible warning if you get too close.

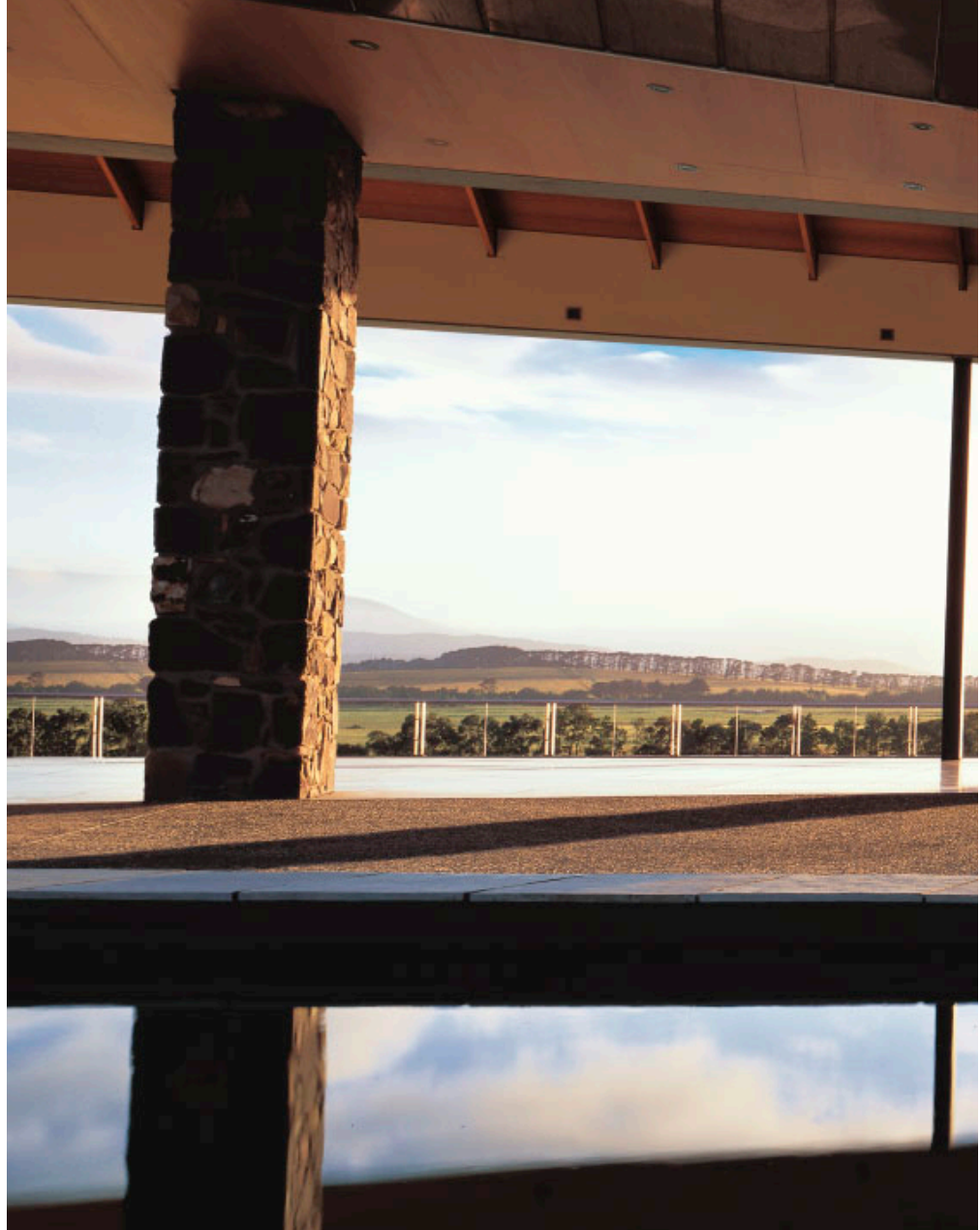



S 0A 5915

210A 5915









C 320 CDI ELEGANCE







*The Estate's comfortable interior is so welcoming that even the most active people will appreciate the chance to sit back and relax. Separate seats and fabric designs have been developed for each of the three lines: Windsor fabric for ELEGANCE, Bristol for CLASSIC and Coventry for AVANTGARDE. When it comes to upholstery colours, you can choose between black, royal blue, pebble beige and alpaca grey. You can also upholster your Estate in fine leather, available as an option*

All information is supplied by the optional COMAND APS control and display system. It features a DVD navigation system and a radio with CD player. The system can be extended with the LINGUATRONIC voice control system, an MP3-compatible CD changer, and the pre-installation for a mobile phone with a universal mobile interface. The optional harman/kardon LOGIC 7® surround sound system with its 12 loudspeakers and 320 watts provides an exceptional listening experience. Other options include the Audio 50 APS with its CD navigation system and an iPod® Interface Kit, which allows you to plug your iPod® into the audio system







*Simple and clear: the seat-adjustment control elements in the door panel. The dials for the standard THERMATIC automatic climate control with its air recirculation switch are trimmed with chrome. The optional electrically folding exterior mirrors can also be conveniently adjusted from inside the car. Headlamp Assist, the standard-fitted light sensor, automatically activates the headlamps when it starts to get dark, for example. A rain sensor is available as an option. It regulates the frequency of the windscreen wipers according to how heavily it is raining. It also moves the open tilting/sliding sunroof to its tilt position when the rain sets in, ensuring fresh air on board while keeping the occupants dry*









## How to maintain your level when you've piled on weight

True sports stars know all about bouncing back when the pressure is on: when you are transporting heavy loads, the automatic self-levelling suspension (optional extra) restores the initial height of the load compartment with the aid of air struts, preventing the rear of the vehicle from lowering under the weight. So if you ever want to make full use of the generous load capacity of up to 1354 litres, you can be sure of optimum roadholding.

Thanks to the special folding mechanism on the rear seats, you can create more stowage space – with a large, flat loading area, if required – in a matter of seconds. But the current Estate has plenty of other tricks up its sleeve to make the interior as flexible as possible: from the luggage cover/retaining net and the collapsible crate for your picnic to the additional stowage compartment beneath the load compartment floor.

*The load compartment provides you with an airy 470 litres of space, expanding to 1354 litres with the rear seats folded down. When the Estate is heavily laden, the optional automatic self-levelling suspension maintains the initial height of the vehicle. Even the spare wheel recess below the load compartment floor can be used as stowage space - thanks to the TIREFIT tyre sealant, the spare wheel is no longer required. The flat loading sill makes the Estate simple to load and unload*

C 200 KOMPRESSOR CLASSIC







*Flexibility is the Estate's speciality - as amply demonstrated by the variable rear bench seat: 1/3, 2/3 or the entire seat can be folded down. When fully folded, a continuous, flat load area is created. It's all down to the special folding mechanism: first the seat cushions are pivoted, then the backrests of the rear seats. The sides feature integral stowage compartments with detachable nets for smaller objects. If you are planning a picnic, the collapsible crate, provided as standard, will come in handy. When not in use, it can be stowed below the load compartment floor. You will also find a 12-V socket on board*

## Good referees only intervene when it's really necessary

If you want to take a sporty drive in the Estate, you will find you're not alone. During your journey, electronic aids act as invisible referees and their decisions help you to stay onside. In critical on-road situations the Electronic Stability Program (ESP®) applies the brake to one or more of the wheels and reduces the engine output as required in order to restabilise the vehicle. This prevents or reduces skidding.

Brake Assist (BAS) also provides crucial support. In an emergency, most drivers apply the brake quickly enough but not hard enough. When this happens, BAS builds up the maximum braking force in fractions of a second. Despite the automatic emergency braking, the wheels do not lock because the anti-lock braking system (ABS) meters the braking force precisely and ensures that the vehicle remains steerable. ABS is partnered by ASR, acceleration skid control, which becomes active if a driven wheel begins to spin. ASR is particularly helpful on slippery road surfaces.













*If you want to reach your destination quickly and safely, it helps if you can anticipate on-road situations - even in the dark. That's why the bi-xenon headlamps are brighter and have a longer range than conventional headlamps. If you select bi-xenon headlamps as an optional extra, you will also enjoy another safety benefit: when cornering with the headlamps on low beam, the left or right fog lamp is activated, illuminating the road more effectively and allowing you to detect pedestrians, for example, at an earlier stage*

C 200 KOMPRESSOR CLASSIC

*Champions understand the importance of control: the multifunction steering wheel can be used to operate the audio, communication and navigation system without taking your hands off the steering wheel. The LCD display shows you the information you require without diverting your attention from the traffic. And the optional LINGUATRONIC voice control system allows you to operate the key functions using just your voice*

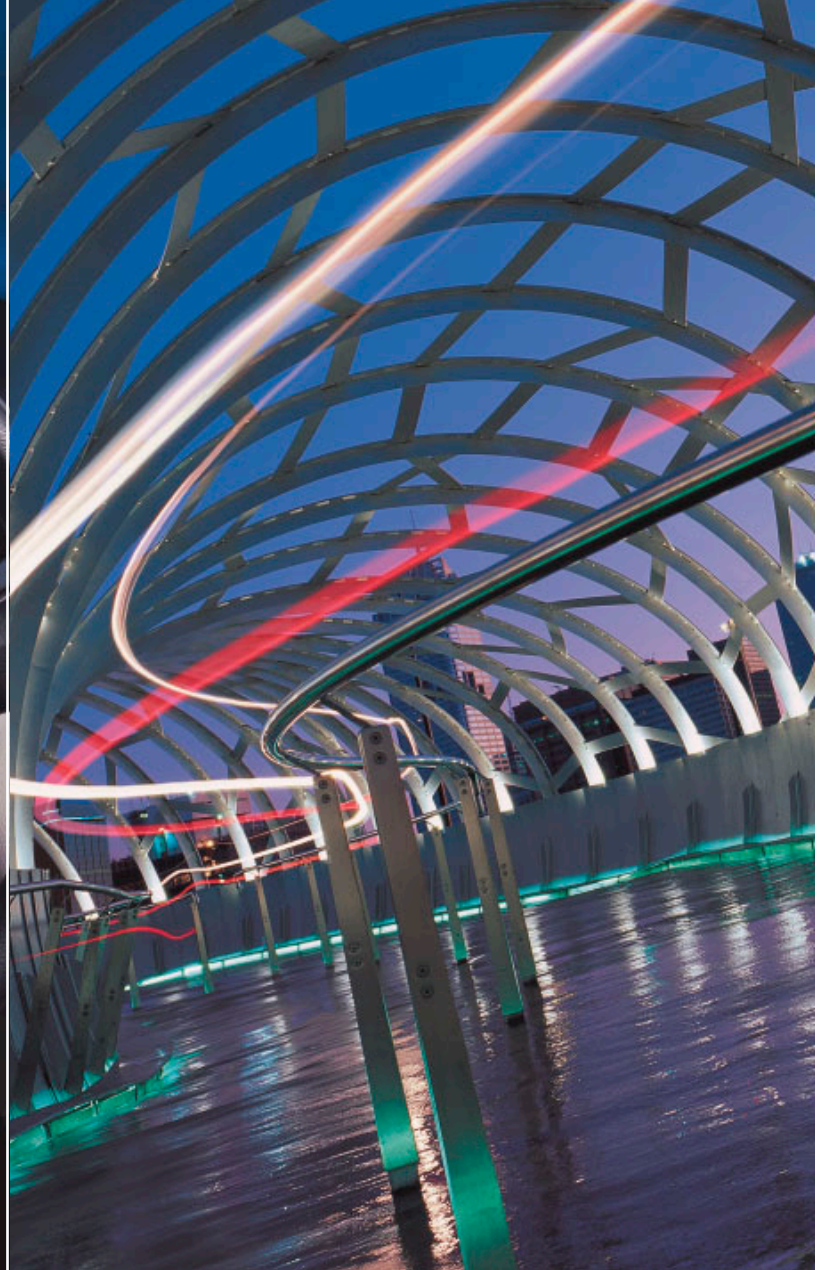





C 200 KOMPRESSOR CLASSIC

*When it comes to sport, a good defence is crucial. In the event of an accident, sensors recognise how serious the impact is and inflate the front airbags in two stages accordingly. The windowbags and sidebags offer additional protection for the head and chest area. In the event of a front or rear-end collision, belt tensioners on the front seats and the outer rear seats pull the belts taut across the body in fractions of a second according to the severity of the accident. The front seats are also fitted with NECK-PRO head restraints. In the event of a rear-end collision, they respond rapidly to support the head, protecting the neck vertebrae*

## Who says there's only one ideal line?

Where the Estate is concerned, all three lines – the CLASSIC, the ELEGANCE and the AVANTGARDE – are hot favourites. The CLASSIC model features eye-catching wheel trims which, together with 16-inch, size 205/55 R 16 wheels and a wider track, create a beefy look. The ELEGANCE and AVANTGARDE models feature specific light-alloy wheel designs and high-shine waist-line trim strips in black with chrome edges.

Which interior is the winner in your books? The Coventry fabric design (AVANTGARDE) is available in black or alpaca grey, the Bristol fabric (CLASSIC) is also available in royal blue and the Windsor fabric (ELEGANCE) comes with a fourth colour option: pebble beige. The trim in the CLASSIC model is in Olive ash wood, in the ELEGANCE model it is in Laurel wood and in the AVANTGARDE model it is in Alu-linea aluminium. Bird's-eye maple wood trim is also available as an exclusive optional extra for the AVANTGARDE.



From left to right: CLASSIC, ELEGANCE, AVANTGARDE





# Standard equipment

## *Selection*

|  |
|--|
| 3-point seat belts and head restraints on all seats<br>(NECK-PRO head restraints for driver and front passenger) |
| 12-volt socket in load compartment   |
| Airbags (two-stage) for driver and front passenger   |
| Armrests, front with stowage compartment, cup holder in front and in rear armrest                                |
| ASSYST service interval indicator  |
| Belt tensioners with belt force limiters, front and outer rear seats   |
| Brake Assist (BAS)   |
| Brake pad wear indicator   |
| Central locking (remote control with selective and global opening)   |
| Clear-lens fog lamps   |
| Collapsible crate in load compartment  |
| Cruise control with SPEEDTRONIC variable speed limiter   |
| DIRECT CONTROL 6-speed manual transmission <sup>1</sup>  |
| DIRECT CONTROL power steering with safety steering column  |
| DIRECT CONTROL suspension  |
| Electronic Stability Program (ESP®)  |
| Flat loading sill, with stainless steel strip  |
| Folding rear bench seat, 1/3:2/3:3/3 split, with load anchorage points   |

|  |
|--|
| Front seats with electrically adjustable height and backrest angle           |
| Headlamp Assist  |
| Heated exterior mirrors, electrically adjustable, with clear-lens indicators |
| High gloss-look clear-lens headlamps   |
| High gloss-look tail lights  |
| Immobiliser with ELCODE locking system and infrared remote control           |
| Load compartment cover and retaining net with one-touch control              |
| Multifunction steering wheel with trip computer                              |
| Outside temperature display  |
| Particulate filter for diesel models   |
| Power windows (4), with one-touch control                                    |
| Roof rails and roof spoiler  |
| Seat occupancy sensor for front passenger seat                               |
| Sidebags for driver and front passenger                                      |
| Steering column manually adjustable for height and reach                     |
| THERMATIC automatic climate control  |
| Tinted glass   |
| Windowbags for driver, front passenger and rear passengers                   |
| Windscreen washer system with heated nozzles                                 |

<sup>1</sup> In the C 280 4MATIC, C 350 4MATIC and C 55 AMG, the 5-speed automatic transmission is standard



## The equipment lines compared

| <i>Selection</i>                                       | <i>CLASSIC</i>  | <i>ELEGANCE</i>   | <i>AVANTGARDE</i>  |
|--|---|---|--|
| Bumpers/rub strips                                     | painted in vehicle colour   | painted in vehicle colour, with chrome trim strip   | painted in vehicle colour, with chrome trim strip  |
| Centre console   | Olive ash wood  | Laurel wood   | Alu-linea aluminium  |
| Door handles   | black-coated  | painted in vehicle colour, with chrome trim   | painted in vehicle colour  |
| Door trim  | -   | Laurel wood   | Alu-linea aluminium  |
| Fabric design  | Bristol   | Windsor   | Coventry <sup>1</sup>  |
| Lettering on rub strip                                 | -   | ELEGANCE  | AVANTGARDE   |
| Radiator grille louveres                               | atlas grey  | high-sheen atlas grey with chrome highlights  | high-sheen black with chrome highlights  |
| Steering wheel, shiftgate surround and gearshift lever | plastic, black  | leather, to match interior appointments   | leather, to match interior appointments  |
| Waistline trim   | haematite   | high-sheen black with chrome edge   | high-sheen black with chrome edge  |
| Wheels   | steel wheel, 16-inch, with wheel trim   | light-alloy wheel, 16-inch, design specific to line                                       | light-alloy wheel, 16-inch, mixed-size tyres, design specific to line                    |
| Windows  | green tinted glass, water-deflectors/roof trim strips powder-coated, deep dark grey | green tinted glass, water-deflectors/roof trim strips anodised aluminium, haematite black | blue tinted glass, water-deflectors/roof trim strips anodised aluminium, haematite black |

- not available

<sup>1</sup> Combined fabric/ARTICO Leather (man-made leather)

## That leading edge – when exceptions become the rule

The C 55 AMG is not a car that meets expectations – it surpasses them. One glance at the technical data tells you that top-class performance is the rule here: AMG 5.5-litre V8 engine, 270 kW (367 hp), maximum torque of 510 Nm, 0 to 100 km/h in 5.4 seconds. The power is controlled via the agile AMG SPEED-SHIFT 5-speed automatic transmission. For an even sportier feel, you can change gear yourself using the AMG shift paddles on the steering wheel. AMG sports suspension, the AMG high-performance braking system and the 18-inch AMG light-alloy wheels provide further evidence of this model's powerful nature. The interior is equally compelling: from the exclusive nappa leather appointments and the AMG sports seats to the AMG instrument cluster and the AMG ergonomic sports steering wheel with shift paddles. The trim is available in Alu-linea aluminium, or in bird's-eye maple as an optional extra.







## Sporting ambitions deserve to be encouraged: the sports packages

The sports package and the AMG sports package emphatically underline the dynamic nature of the Estate. The sports package comprises sports suspension and 17-inch, 5-spoke light-alloy wheels, with mixed-size tyres, size 225/45 at the front and 245/40 at the rear. On the petrol models an oval-design, stainless steel exhaust tailpipe gleams at the rear, while the diesel models feature two chromed tailpipes. And because an athlete has to master more than just rapid acceleration, a sports braking system with perforated brake discs brings the Estate to a standstill just as promptly. Further highlights of the sports package can be found inside: sports seats provide perfect support for the driver and front passenger, particularly on bends. The seats are upholstered in ARTICO man-made leather as standard. Leather upholstery is available as an option. When you want to put your foot down, there are studded pedals in brushed stainless steel. For steering there is a 3-spoke multifunction steering wheel with thumbrests and for changing gear a short leather-trimmed gearshift lever or – in conjunction with an automatic transmission – the new shift paddles.













*The AMG sports package includes all the equipment features of the sports package plus AMG bodystyling, which consists of a sporty front apron with integral fog lamps, a rear apron and side skirts. Sterling silver-painted 17-inch AMG light-alloy wheels in the new 5-spoke design, with size 225/45 tyres at the front and 245/40 at the rear, round off the AMG sports package*

*AMG sports package*

## How do you make a powerful impression before the start? With style

If you're after a sporty yet elegant outfit for your C-Class Estate, designo could be just what you're looking for: the creative designo specialists are masters in their field. They have specially developed a broad range of exclusive paint finishes. And when it comes to fine wood trim for the interior, you can choose between anthracite cinnamora and striking designo brown poplar. The single-tone designo leather seats are available in the standard CLASSIC, ELEGANCE or AVANTGARDE colours. Or if you prefer a two-tone variation, you can combine black with a choice of various designo leather colours. For more information and further inspiration, see our designo brochure.







*Unbeatable when it comes to dignity and poise: the leather upholstery and door trim from designo are available in stylish colour combinations - giving the interior of your Estate a presence that sets it apart from the field*

## The open-air sports arena

The C-Class Estate offers you every conceivable comfort – as our extensive range of optional extras amply demonstrates. Take, for example, the electric tilting/sliding glass sunroof. On fine days it provides you with more sunlight – and more fresh air. If it starts to rain, the optional rain sensor ensures that the tilting/sliding sunroof automatically moves into its tilt position.





## Optional extras

### **Selection**

---

5-speed automatic transmission<sup>1</sup>

---

7G-TRONIC 7-speed automatic transmission<sup>2</sup>

---

AMG sports package<sup>4</sup>

---

Anti-theft alarm system (ATA) with tow-away protection

---

Audio 20 CD radio

---

Audio 50 APS radio with CD drive

---

Automatic self-levelling suspension

---

Auxiliary heater with remote control

---

Bi-xenon headlamps with cornering light function<sup>3</sup>

---

CD changer (for 6 CDs) in glove compartment, MP3-compatible

---

COMAND APS control and display system with DVD drive

---

Electric tilting/sliding glass sunroof

---

Exterior mirrors left and right, folding and automatically dimming

---

Front seat right electrically adjustable with memory function<sup>5</sup>

---

harman/kardon LOGIC 7<sup>®</sup> surround sound system

---

Heated front seats

---

---

Leather steering wheel and shift/selector lever for C-Class CLASSIC

---

Leather upholstery

---

LINGUATRONIC voice control system

---

Memory package for driver's seat, exterior mirrors and steering column

---

PARKTRONIC

---

Pre-installation for mobile phone

---

Privacy windows

---

Rain sensor for windscreen wipers

---

Sidebags in rear

---

Ski bag

---

Sports package<sup>4</sup>

---

Sports suspension<sup>4</sup>

---

THERMOTRONIC luxury automatic climate control

---

Trailer coupling with detachable ball neck

---

Tyre pressure loss warning system

---

<sup>1</sup>Standard on C 280 4MATIC, C 350 4MATIC and C 55 AMG

<sup>2</sup>Available for C 320 CDI, C 230, C 280 and C 350

<sup>3</sup>Cornering light function not available in conjunction with AMG sports package or C 55 AMG

<sup>4</sup>Not available for C 280 4MATIC, C 350 4MATIC or C 55 AMG

<sup>5</sup>Only in conjunction with memory package

*You can also opt for particularly sporty footwear for your Estate: the 17-inch, twin-spoke wheels, size 225/45 at the front and 245/40 at the rear, are available for all lines. The sports package includes 17-inch, 5-spoke light-alloy wheels (size 225/45 at the front and 245/40 at the rear), and there are also 16-inch, 7-spoke wheels (size 205/55 front and rear) for the CLASSIC and ELEGANCE lines*





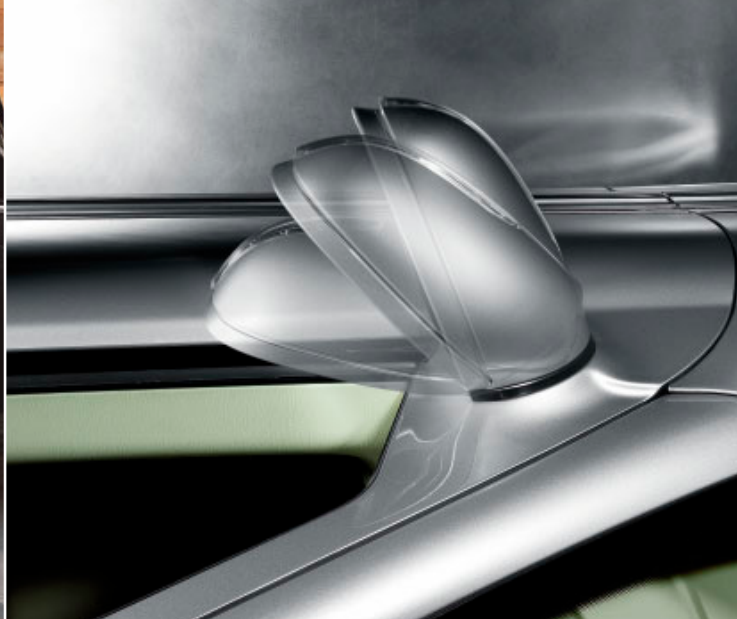

*As nifty and cunning as a top-class striker: electrically folding exterior mirrors with an automatic dimming function are available as an optional extra. And the optional PARKTRONIC system helps make parking a breeze. Ten sensors emit ultrasonic signals which are reflected by any obstacles in the vehicle's path. A microcomputer continuously calculates how far you are away from these obstacles and uses displays on the dashboard and in the rear of the interior plus acoustic signals to keep you informed*

*Moving up a league:  
the roof box from the range  
of accessories for the  
C-Class Estate. It has a  
capacity of 330 litres  
and also scores points  
with its elegant design*







*Top left: the Alustyle ski and snowboard rack, which allows you to transport up to four pairs of skis or two snowboards. Alongside it on the right: one of our child seats, which can be adjusted to suit the size of the young passenger. To keep your refreshments cool and fresh on hot days, our range includes a universal coolbox (bottom left). And the snap-in stowage system for the spare wheel recess (bottom right) provides extra stowage space. Up to five snap-in stowage trays can be arranged as required, allowing the system to be adapted perfectly to the items you are transporting*

**Non-metallic  
paints**

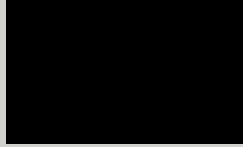

040 black



590 fire opal

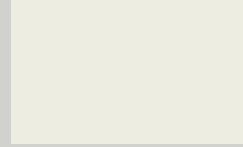

650 calcite white

**Metallic paints  
optional extra**



197 obsidian black



300 periclase green



345 jasper blue<sup>1</sup>



359 tanzanite blue



544 carneol red



723 cubanite silver

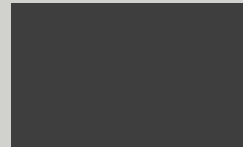

747 perlite grey



775 iridium silver

**Special  
metallic paint  
optional extra for  
AVANTGARDE**

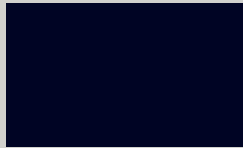

768 diamond black

<sup>1</sup>Not available for C 55 AMG

**Tougher clearcoat**

*The clearcoat used on the C-Class is significantly more scratch-resistant than conventional paint and is characterised by a more durable sheen which is noticeably more intense. The secret of this protective coat is to be found in the countless tiny ceramic particles (each less than one millionth of a millimetre in size) which are integrated in the paint binding agent. Both non-metallic and metallic paint finishes benefit from the more scratch-resistant clearcoat which makes them less susceptible to the effects of the weather and environmental conditions such as precipitation, sunlight, temperature variations, dust and soot*



Olive ash wood  
standard for  
CLASSIC



Laurel wood  
standard for  
ELEGANCE

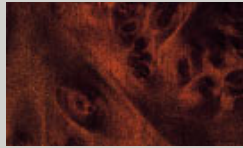

Alu-linea  
aluminium  
standard for  
AVANTGARDE  
and C 55 AMG



Bird's-eye  
maple wood  
optional extra for  
AVANTGARDE  
and C 55 AMG



Bristol fabric  
standard for  
CLASSIC



011 black



012 royal blue



018 alpaca grey

Windsor fabric  
standard for  
ELEGANCE



411 black



412 royal blue

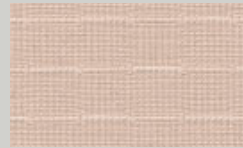

415 pebble beige

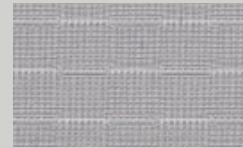

418 alpaca grey

Coventry  
fabric<sup>1</sup>  
standard for  
AVANTGARDE



711 black



718 alpaca grey

<sup>1</sup> Combined fabric/ARTICO Leather (man-made leather) upholstery

**ARTICO Leather<sup>1</sup>**  
*optional extra for  
CLASSIC and  
ELEGANCE*



*141 black<sup>2</sup>*



*145 pebble beige*



*148 alpaca grey*

**Leather**  
*optional extra for  
ELEGANCE*

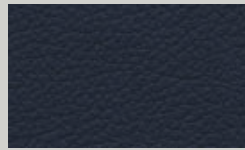

*212 royal blue*

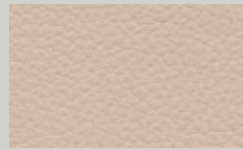

*215 pebble beige*

**Leather**  
*optional extra for  
ELEGANCE and  
AVANTGARDE*

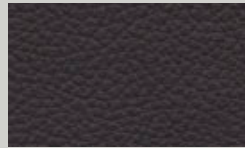

*211 (E), 221 (A) black*

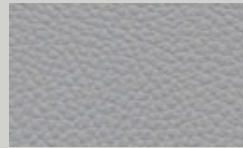

*218 (E), 228 (A) alpaca grey*

**Nappa leather**  
*available only  
as standard  
for C 55 AMG*

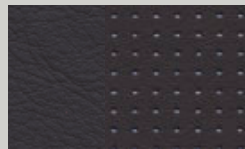

*841 black*



*848 alpaca grey*

**designo  
trim**  
*optional extra*



*W52 anthracite cinnamora*



*W68 brown poplar*

<sup>1</sup>Man-made leather

<sup>2</sup>Standard with sports package and AMG sports package



## Paintwork and upholstery - the combination options

|                               | <i>Bristol fabric</i> |            |             | <i>Windsor fabric</i> |            |              |             | <i>Coventry fabric<sup>1</sup></i> |             | <i>ARTICO Leather<sup>2</sup>/Leather</i> |            |              |             | <i>Nappa leather<sup>3</sup></i> |             |
|-------------------------------|-----------------------|------------|-------------|-----------------------|------------|--------------|-------------|------------------------------------|-------------|---|------------|--------------|-------------|----------------------------------|-------------|
|                               | black                 | royal blue | alpaca grey | black                 | royal blue | pebble beige | alpaca grey | black                              | alpaca grey | black                                     | royal blue | pebble beige | alpaca grey | black                            | alpaca grey |
| <i>Non-metallic paints</i>    |                       |            |             |                       |            |              |             |                                    |             |   |            |              |             |                                  |             |
| black                         | ●                     | △          | ●           | ●                     | △          | ●            | ●           | ●                                  | ●           | ●   | △          | ●            | ●           | ●                                | ●           |
| fire opal                     | ●                     | △          | ○           | ●                     | △          | ○            | ○           | ●                                  | ○           | ●   | △          | ○            | ○           | ●                                | ○           |
| calcite white                 | ●                     | ●          | ●           | ●                     | ●          | ○            | ●           | ●                                  | ●           | ●   | ●          | ○            | ●           | ●                                | ●           |
| <i>Metallic paints</i>        |                       |            |             |                       |            |              |             |                                    |             |   |            |              |             |                                  |             |
| obsidian black                | ●                     | △          | ●           | ●                     | △          | ●            | ●           | ●                                  | ●           | ●   | △          | ●            | ●           | ●                                | ●           |
| periclase green               | ●                     | △          | ○           | ●                     | △          | ●            | ○           | ●                                  | ○           | ●   | △          | ●            | ○           | -                                | -           |
| jasper blue                   | ●                     | △          | ○           | ●                     | △          | △            | ○           | ●                                  | ○           | ●   | △          | △            | ○           | -                                | -           |
| tanzanite blue                | ●                     | ●          | ●           | ●                     | ●          | ●            | ●           | ●                                  | ●           | ●   | ●          | ●            | ●           | ●                                | ●           |
| carneol red                   | ●                     | △          | ●           | ●                     | △          | ●            | ●           | ●                                  | ●           | ●   | △          | ●            | ●           | -                                | -           |
| cubanite silver               | ●                     | ●          | ●           | ●                     | ●          | ○            | ●           | ●                                  | ●           | ●   | ●          | ○            | ●           | ●                                | ●           |
| perlite grey                  | ●                     | ●          | ●           | ●                     | ●          | ○            | ●           | ●                                  | ●           | ●   | ●          | ○            | ●           | ●                                | ●           |
| iridium silver                | ●                     | ●          | ●           | ●                     | ●          | △            | ●           | ●                                  | ●           | ●   | ●          | △            | ●           | ●                                | ●           |
| <i>Special metallic paint</i> |                       |            |             |                       |            |              |             |                                    |             |   |            |              |             |                                  |             |
| diamond black                 | -                     | -          | -           | -                     | -          | -            | -           | ●                                  | ●           | ●   | -          | -            | ●           | ●                                | ●           |

● Recommended    ○ Possible    △ Not recommended    - Not available

<sup>1</sup> Combined fabric/ARTICO Leather (man-made leather) upholstery

<sup>2</sup> Man-made leather upholstery

<sup>3</sup> Available for C 55 AMG only

## Technical data

|  | <i>C 200 CDI</i>                 | <i>C 220 CDI</i>           | <i>C 320 CDI</i>                 | <i>C 180<br/>KOMPRESSOR</i>      | <i>C 200<br/>KOMPRESSOR</i>      |
|--|----------------------------------|----------------------------|----------------------------------|----------------------------------|----------------------------------|
| No. of cylinders/arrangement   | 4/in-line                        | 4/in-line                  | 6/V                              | 4/in-line                        | 4/in-line                        |
| Bore/stroke (mm)   | 88.0/88.3                        | 88.0/88.3                  | 83.0/92.2                        | 82.0/85.0                        | 82.0/85.0                        |
| Total displacement (cc)  | 2148                             | 2148                       | 2987                             | 1796                             | 1796                             |
| Rated output (kW at rpm) <sup>1</sup>                                  | 90/4200                          | 110/4200                   | 165/3800                         | 105/5200                         | 120/5500                         |
| Rated torque (Nm at rpm) <sup>1</sup><br>(automatic transmission)      | 270/1600–2800<br>(270/1600–2800) | 340/2000<br>(340/2000)     | 415/1400–3800<br>(510/1600–2800) | 220/2500–4200<br>(220/2500–4200) | 240/3000–4000<br>(240/3000–4000) |
| Compression ratio  | 18.0                             | 18.0                       | 17.7                             | 10.0                             | 9.3                              |
| Acceleration 0–100 km/h (s) (automatic transmission)                   | 12.2 (12.4)                      | 10.5 (10.8)                | 8.3 (7.1)                        | 10.0 (10.2)                      | 9.4 (9.7)                        |
| Top speed, approx. (km/h) (automatic transmission)                     | 202 (197)                        | 218 (212)                  | 244 (241)                        | 216 (213)                        | 228 (225)                        |
| Tyre size  | front<br>rear                    | front<br>rear              | front<br>rear                    | front<br>rear                    | front<br>rear                    |
|  | 205/55 R 16<br>205/55 R 16       | 205/55 R 16<br>205/55 R 16 | 225/45 R 17<br>225/45 R 17       | 205/55 R 16<br>205/55 R 16       | 205/55 R 16<br>205/55 R 16       |
| Fuel   | Diesel                           | Diesel                     | Diesel                           | Premium                          | Premium                          |
| Fuel consumption (l/100 km) <sup>3</sup>                               |                                  |                            |                                  |                                  |                                  |
| urban (automatic transmission)   | 9.1–9.2 (9.5–9.6)                | 9.2–9.3 (9.6–9.7)          | 10.0–11.1 (10.5–10.9)            | 11.8–12.2 (12.0–12.1)            | 12.0–12.7 (12.4–12.8)            |
| extra-urban (automatic transmission)                                   | 5.6 (5.8–5.9)                    | 5.5–5.6 (5.9–6.0)          | 5.8–6.4 (5.9–6.1)                | 6.5–6.8 (6.6–6.7)                | 6.7–7.1 (6.6–7.0)                |
| combined (automatic transmission)                                      | 6.8–6.9 (7.1–7.2)                | 6.9–7.0 (7.2–7.3)          | 7.4–8.1 (7.6–7.9)                | 8.4–8.8 (8.5–8.7)                | 8.7–9.1 (8.7–9.1)                |
| CO <sub>2</sub> emissions (g/km) <sup>3</sup> (automatic transmission) | 180–183 (188–190)                | 180–183 (190–192)          | 193–214 (199–208)                | 201–209 (203–206)                | 207–217 (206–217)                |
| Tank capacity, incl. reserve, approx. (l)                              | 62/8                             | 62/8                       | 62/8                             | 62/8                             | 62/8                             |
| Turning circle diameter (m)  | 10.76                            | 10.76                      | 10.76                            | 10.76                            | 10.76                            |
| Kerb weight <sup>4</sup> /perm. GVW (kg)                               | 1565/2090                        | 1590/2115                  | 1680/2205                        | 1535/2060                        | 1535/2060                        |



| <i>C 230</i>                         | <i>C 280</i>                         | <i>C 280 4MATIC</i>    | <i>C 350</i>                         | <i>C 350 4MATIC</i>    | <i>C 55 AMG</i>       |
|--------------------------------------|--------------------------------------|------------------------|--------------------------------------|------------------------|-----------------------|
| 6/V                                  | 6/V                                  | 6/V                    | 6/V                                  | 6/V                    | 8/V                   |
| 88.0/68.4                            | 88.0/82.1                            | 88.0/82.1              | 92.9/86.0                            | 92.9/86.0              | 97.0/92.0             |
| 2496                                 | 2996                                 | 2996                   | 3498                                 | 3498                   | 5439                  |
| 150/6100                             | 170/6000                             | 170/6000               | 200/6000                             | 200/6000               | 270/5750              |
| 245/2900 – 5500<br>(245/2900 – 5500) | 300/2500 – 5000<br>(300/2500 – 5000) | –<br>(300/2500 – 5000) | 350/2400 – 5000<br>(350/2400 – 5000) | –<br>(350/2400 – 5000) | –<br>(510/4000)       |
| 11.2                                 | 11.1                                 | 11.1                   | 10.5                                 | 10.5                   | 11.0                  |
| 8.6 (9.1)                            | 7.5 (7.5)                            | – (7.9)                | 6.5 (6.5)                            | – (7.1)                | – (5.4)               |
| 235 (228)                            | 248 (241)                            | – (237)                | 250 <sup>2</sup> (250 <sup>2</sup> ) | – (250 <sup>2</sup> )  | – (250 <sup>2</sup> ) |
| 205/55 R 16                          | 205/55 R 16                          | 205/55 R 16            | 225/45 R 17                          | 225/45 R 17            | 225/40 R 18           |
| 205/55 R 16                          | 205/55 R 16                          | 205/55 R 16            | 225/45 R 17                          | 225/45 R 17            | 245/35 R 18           |
| Premium                              | Premium                              | Premium                | Premium                              | Premium                | Super Plus            |
| 13.6 – 13.9 (13.4 – 13.7)            | 13.8 – 14.1 (13.2 – 13.5)            | – (14.0 – 14.2)        | 14.0 – 14.3 (14.2 – 14.5)            | – (14.5 – 14.8)        | – (17.8)              |
| 7.2 – 7.5 (7.3 – 7.6)                | 7.4 – 7.7 (7.4 – 7.7)                | – (7.9 – 8.1)          | 7.4 – 7.7 (7.8 – 8.1)                | – (8.2 – 8.5)          | – (9.2)               |
| 9.6 – 9.9 (9.5 – 9.8)                | 9.7 – 10.0 (9.6 – 9.9)               | – (10.2 – 10.4)        | 9.8 – 10.1 (10.2 – 10.5)             | – (10.5 – 10.8)        | – (12.3)              |
| 229-237 (226 – 233)                  | 232 – 239 (229 – 236)                | – (243 – 248)          | 234 – 241 (245 – 252)                | – (250 – 257)          | – (293)               |
| 62/8                                 | 62/8                                 | 62/8                   | 62/8                                 | 62/8                   | 62/8                  |
| 10.76                                | 10.76                                | 10.76                  | 10.76                                | 10.76                  | 10.76                 |
| 1580/2105                            | 1585/2110                            | 1690/2215              | 1600/2125                            | 1705/2230              | 1695/2200             |

<sup>1</sup> Figures according to Directive 80/1269/EEC in the currently applicable version    <sup>2</sup> Electronically governed    <sup>3</sup> The figures shown were obtained in accordance with the prescribed measuring process (Directive 80/1268/EEC in the currently applicable version). The figures are not based on an individual vehicle and do not constitute part of the product offer; they are provided solely for purposes of comparison between different vehicle models    <sup>4</sup> Figures according to Directive 92/21/EC, version 95/48/EC (kerb weight with fuel tank 90 % full, with driver, 68 kg, and luggage, 7 kg) for standard-specification vehicles. Optional extras and accessories will generally increase this figure and reduce the payload capacity accordingly

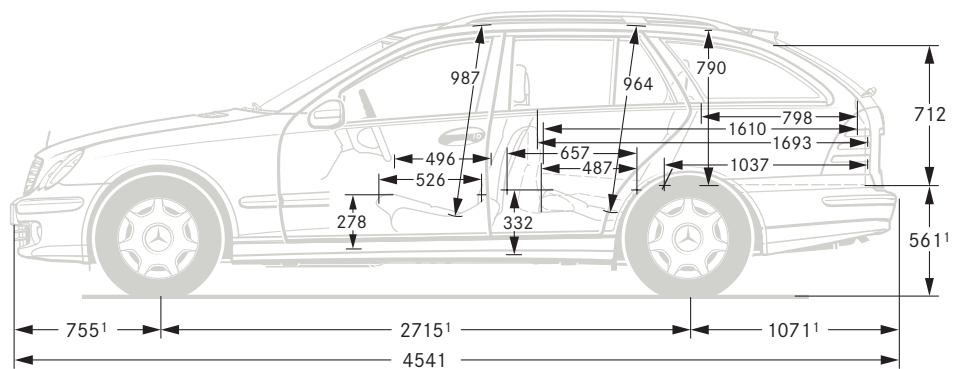
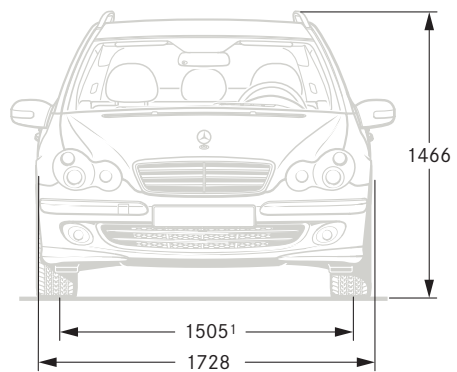



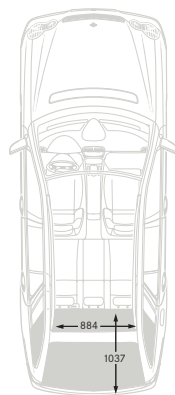
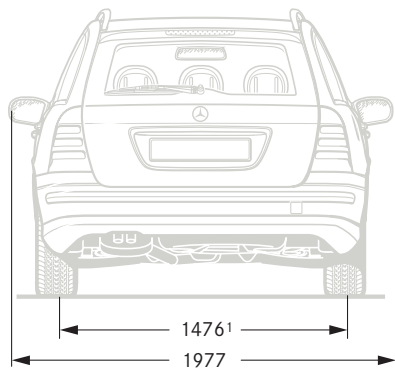

*5 seats*

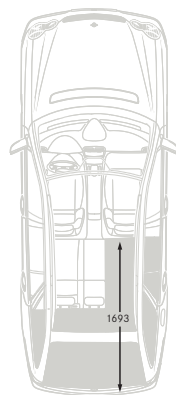

*4 seats*

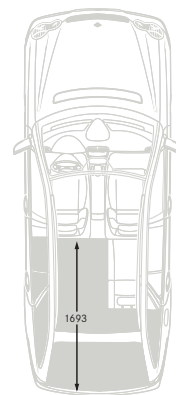

*3 seats*

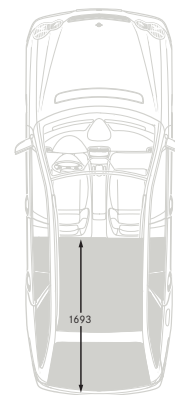

*2 seats*

The dimensions, shown in mm, are average values for the unladen, standard-specification vehicle

<sup>1</sup>Carrying 3 people, each weighing 68 kg. Vehicle without number plate adapter (6 mm)

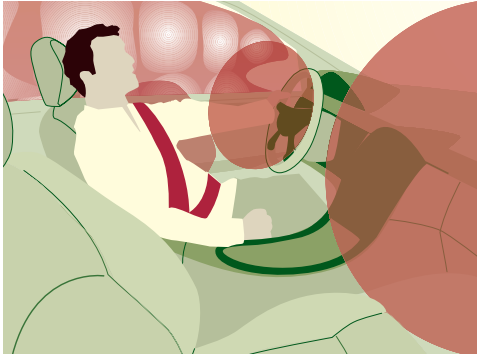

#### **Airbags and belt system**

The C-Class is fitted with selective front airbags plus sidebags and windowbags, all of which are activated in accordance with the type and severity of a collision. In the event of a frontal collision the electronics deploy the front airbags in two stages, depending on the severity of the accident, offering the front occupants an appropriate level of protection. The sidebags provide increased protection for the chest area, while the windowbags offer protection for the head, expanding like a curtain between the A and C-pillars. Belt tensioners on the front and on the outer rear seats pull the belts against the body in fractions of a second in the event of a frontal or rear-end collision of a specific severity.

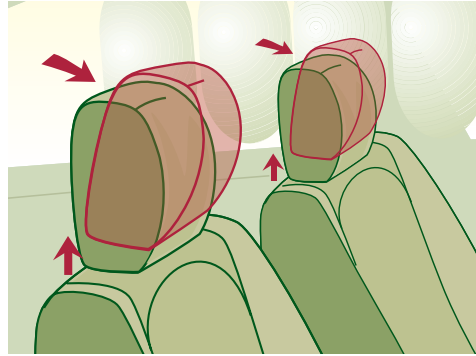

#### **NECK-PRO**

The new NECK-PRO head restraint system for the driver and front passenger responds rapidly to support the head in the event of a rear-end collision. Sensors trigger pre-stressed springs, moving the head restraints forward 44 mm and up 30 mm. NECK-PRO thereby helps to minimise the risk of possible whiplash injuries in a rear-end collision. Once triggered, the head restraints can be returned to their original position manually.

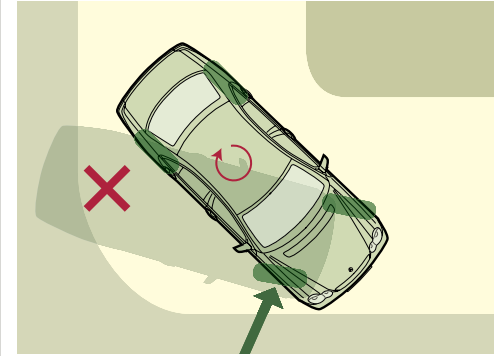

#### **ESP® with tyre pressure loss warning system**

If your car is in danger of skidding, the Electronic Stability Program (ESP®) is instantly activated. The sensors recognise critical dynamic handling situations at an early stage, e.g. the fact that a wheel is spinning or is in danger of losing contact with the road. ESP® throttles back the engine torque and brakes one or more wheels as required in order to stabilise the vehicle. The integral tyre pressure loss warning function can detect severe loss of pressure in a tyre and indicates this in the instrument cluster. It is still vital, however, that you check the tyre pressure and condition on a regular basis.

Further information regarding active and passive safety is available on the Internet; please visit [www.mercedes-benz.com/airbag-brochure](http://www.mercedes-benz.com/airbag-brochure)



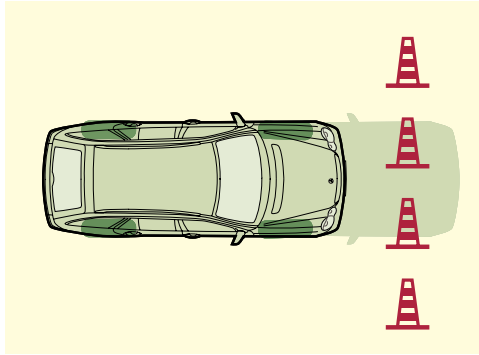

#### **BAS**

The electronic Brake Assist system (BAS) recognises emergency braking by the speed with which you apply the brake and instantly builds up the maximum braking force, bringing the car to a standstill faster. Thanks to the anti-lock braking system (ABS), the wheels do not lock when automatic emergency braking is triggered, and the car remains steerable. When the driver takes his or her foot off the brake pedal again, the automatic brake booster is deactivated.

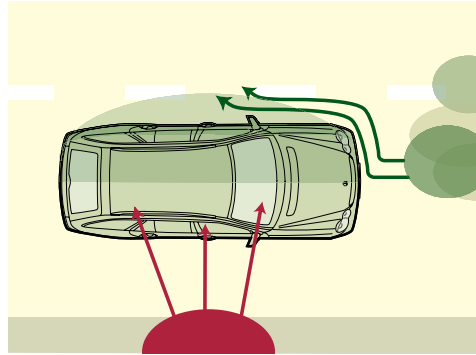

#### **THERMOTRONIC luxury automatic climate control**

The driver and front passenger can each configure their own preferred temperature and airflow settings. Sensors monitor the intensity of the sunlight, while the intake-air quality is improved by a dust filter and an activated charcoal filter. The interior temperature and blower settings are adjusted automatically to create a pleasant atmosphere. A dew-point sensor monitors air humidity to prevent the windows from misting up. The control unit's clear display makes the system simple to use.

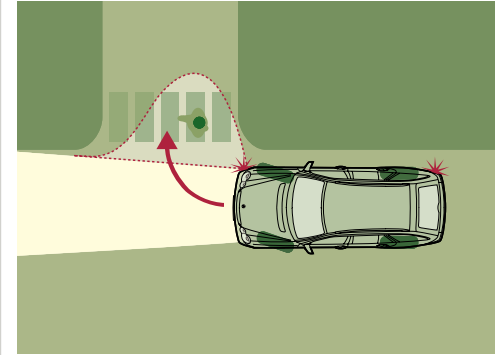

#### **Cornering light function**

The cornering light function is an extended feature of the optional bi-xenon headlamps. By dispersing the light from the fog lamp more widely, the cornering light ensures significantly better illumination of the road into which the vehicle is turning. The left or right fog lamp is activated when the headlamps are on, the vehicle speed is below 40 km/h and the indicator is on or the relevant steering angle is achieved. The cornering light function means that pedestrians and potential obstacles can be detected at an early stage and accidents avoided.

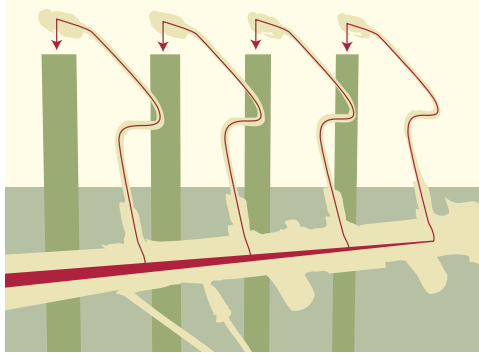

#### **Common-rail diesel engines**

Smooth and quiet operation, economy, low emissions and driving pleasure – the special qualities of the common-rail diesel engines. Responsible for this all-round talent is a common fuel supply pipe, or rail, which keeps the fuel at a permanently high pressure of around 1600 bar throughout the entire engine speed range and injects finely atomised, precisely metered quantities of fuel into the combustion chambers.

The result is a reduction in fuel consumption and lower pollutant emissions. Noise emissions and engine vibration have also been significantly reduced. The good torque values are the result of, among other things, the turbocharger with a variable nozzle turbine (VNT) and the charge-air cooling.

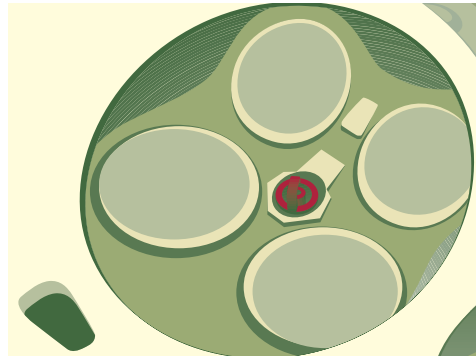

#### **6-cylinder petrol engines with 4 valves per cylinder**

4-valve technology, combined with adjustable intake and exhaust camshafts, improves the rated output and torque of the new V6 engines across a broad engine speed range. The sophisticated air intake concept and the optimised combustion chamber design also lower fuel consumption and exhaust emissions. A balancer shaft ensures quieter engine operation and reduces vibrations.

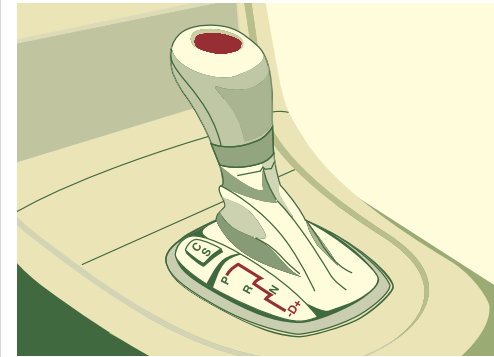

#### **7G-TRONIC**

The world's first 7-speed automatic transmission ensures barely perceptible gearshifts, even in the upper gears. Thanks to the integral transmission control, with faster direct control of the gears, which allows several gears to be skipped, pulling power and acceleration are significantly enhanced. A second reverse gear with a higher transmission ratio makes pulling away on ice and snow easier and safer. The seven gears make for smaller shifts in engine speed. The torque converter helps reduce consumption while enhancing acceleration. Noise emissions remain low.



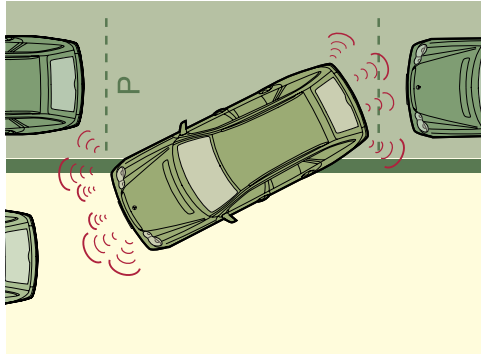

#### **PARKTRONIC**

This electronic system helps you to park and to manoeuvre your way out of a tight parking spot. Like a depth sounder, it sends out ultrasonic signals which are bounced back off obstacles in your vehicle's path. Displays in the interior show how close the vehicle is to a detected obstacle. Depending on the distance, yellow or red signals provide warnings. If the gap falls below a certain limit, PARKTRONIC also emits a continuous acoustic warning.

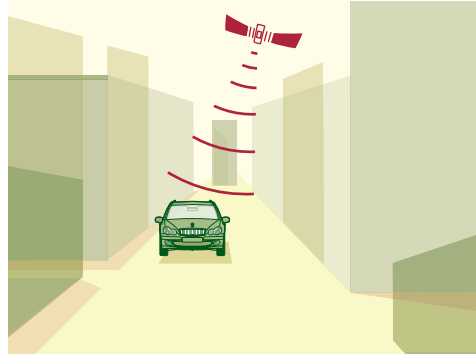

#### **COMAND APS**

A DVD navigation module (for most European countries) can be added to the COMAND control and display system to create COMAND APS. It works with the Global Positioning System (GPS). Enter your destination into the system, and COMAND APS works out the route. Voice instructions or direction arrows in the display tell you which way to go. Dynamic route guidance is an additional service (available in Germany and some other European countries), which uses information provided by radio stations to guide you around tailbacks where there is an alternative route.



#### **LINGUATRONIC**

To operate the telephone, the audio/video system and the navigation system, all you need is your voice and LINGUATRONIC. The system helps enhance safety since it allows you to keep both hands on the steering wheel. If LINGUATRONIC is activated, you can use a selection of easy-to-remember commands to save numbers, for example, access your phone book and make phone calls. Many other functions, such as selecting a waveband and searching for a station, can also be voice-controlled. It is now also possible to input destination details for the navigation system orally and to voice-control other functions.

Our service is your gateway to the world



[www.mercedes-benz.com](http://www.mercedes-benz.com)

Step into the world of Mercedes-Benz on-line and find out more about the brand. From its history, for example in our virtual museum to the company's latest innovations, for example in the far-sighted field of fuel cell technology. Our technology glossary keeps you up-to-date with new developments. Cars and culture? Mercedes-Benz is well-known for its sponsorship programmes, so it's only logical that we also provide you with up-to-the-minute information on motor shows, exhibitions, international fashion trends, fashion weeks and sports events. Have we awakened your interest in motorsport? Formula 1? On-line you can find all the latest results and news, and even order tickets. And of course we haven't forgotten the children. In Cedy's World there are games, a forum where your children can meet others and plenty of opportunities to learn all about cars, technology and the environment. As you can see, the virtual world can sometimes be as exciting as the real one.



### **MobiloLife**

With MobiloLife, our mobility and warranty package, you can expect years of carefree driving. Whether you have lost your key, are having problems starting the car or it breaks down and cannot be repaired immediately, the mobility package ensures that you still reach your destination, anywhere in the European Union. Under certain circumstances we even meet the cost of an airline ticket. And if help takes longer than expected, we put you up in a hotel of your choice. But don't get too excited – it's very rare for a Mercedes to break down. Call Mercedes-Benz on 00800 1777 7777 from almost any European landline or mobile network and our Service 24h team will assist you in your own language. Our staff are there for you 24 hours a day, 365 days a year. Your vehicle documents provide details of the alternative phone numbers for each country. MobiloLife will also help if you bring your car in for a major warranty or policy repair; it applies to a new vehicle for a period of 2 years and is then automatically renewed every time a service is carried out by a Mercedes-Benz service centre, remaining valid until the next service is due – for a maximum of 30 years. Our service even includes a warranty against rusting through from the inside. For more detailed information on MobiloLife, see your vehicle documents.

### **MercedesCard**

There's also a wealth of experiences to enjoy when you're not sitting at the wheel of your Mercedes-Benz. Owning a MercedesCard is all it takes. It acts as your ticket to the world of Mercedes-Benz and doubles as a practical credit card. The MercedesCard Journal contains details of a selection of sporting, cultural and travel events, put together especially for you. Customers in Germany can find further information, along with application forms, at [www.mercedes-benz.de/mercedescard](http://www.mercedes-benz.de/mercedescard). Customers in Austria and Switzerland will find the information on their national websites.

### **DaimlerChrysler Bank – financial services**

If you have already set your heart on your dream Mercedes and want to remain flexible in financial terms, you may be interested in our range of financial services. Our single-source leasing, financing, insurance and service packages could be exactly what you're looking for. The on-line calculator allows you to work out your monthly payments for yourself. In addition to individually geared financial services, we can also offer you tailor-made investment products, including an instant-access savings account, fixed-interest investments and portfolio funds. For further information, call us on 0 18 03-DC BANK or 0 18 03-32 22 65 (9 ct/min), or visit: [www.daimlerchrysler-bank.com](http://www.daimlerchrysler-bank.com)

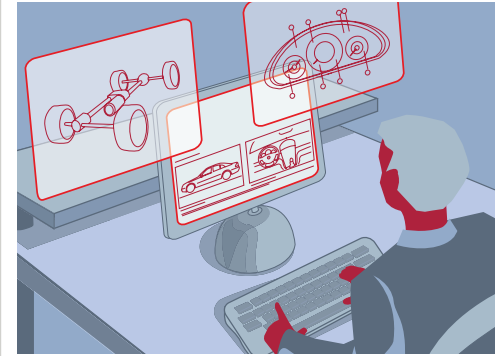

### **Interactive Owner's Manual**

If you want less to read and more to try out for yourself, visit the interactive Owner's Manual from Mercedes-Benz. Our website features informational clips and simulations designed to help you familiarise yourself with the various functions of your car. Discover the technical facts and figures and get a clear picture of a select range of functions that make driving such a joy. For further details, go to: [www.mercedes-benz.de/betriebsanleitung](http://www.mercedes-benz.de/betriebsanleitung)













### **Take-back of end-of-life vehicles. Coming full circle**

At the end of its long life, you can return your C-Class Estate to us for environment-friendly disposal in accordance with the EC End-Of-Life Vehicle Directive.<sup>1</sup>

But that day lies a long way off.

<sup>1</sup>Applies in accordance with national regulations to vehicles up to 3.5 t permissible gross weight. The C-Class Estate has met the statutory regulations governing the suitability of the vehicle's design for reuse and recycling for a number of years now. A network of vehicle take-back depots and dismantlers has been established which will process your vehicle in an environment-friendly manner. The ways in which both vehicles and parts can be recovered are subject to ongoing development and improvement. Consequently, the C-Class Estate will be able to comply with any future increases in the recycling quota within the stipulated time limits. For further information, please call 00800 1777 7777.

Please note: changes may have been made to the product since this brochure went to press (28.02.2006). The manufacturer reserves the right to make changes to the design, form, colour and specification during the delivery period, provided these changes, while taking into account the interests of the vendor, can be deemed reasonable with respect to the purchaser. Where the vendor or the manufacturer uses symbols or numbers to describe an order or the subject of an order, no rights may be derived solely from these. The illustrations may show accessories and items of optional equipment which are not part of standard specification. Colours may differ slightly from those shown in the brochure, owing to the limitations of the printing process. This brochure has been compiled by DaimlerChrysler AG of Germany and is distributed internationally. It provides a general indication of the range of models, features, optional extras and/or colours available in various countries. Some of the models, features, optional extras and/or colours shown may not be available in your country or may only be available in a different specification. Additionally some models, features, optional extras and/or colours may only be available in combination with others. For current and more specific information in relation to the range of models, features, optional extras and/or colours available in your country, and their pricing, you should contact your nearest authorised Mercedes-Benz Passenger Car Dealer.