



Mercedes-Benz

BlueTec<sup>®</sup> SCR diesel technology

The future... now. BlueTec<sup>®</sup>



# Australian emission laws are now tougher. Make sure you reap the benefits.

**New solutions.** There is now an economical solution for anyone wishing to ready themselves for future emissions legislation today: BlueTec®, the SCR diesel technology for heavy and medium duty commercial vehicles from Mercedes-Benz. With this technology, a catalytic converter is responsible for reducing nitrogen oxide emissions. This is done with the aid of an additive called AdBlue, which is fed from a separate tank. AdBlue is an aqueous, non-toxic solution that helps to convert nitrogen oxides into harmless substances. BlueTec® has the added advantage of working extremely economically.

**New benefits.** Up until now, vehicle manufacturers have been faced with a dilemma: it was simply impossible to lower nitrogen oxide and particulate emissions whilst also cutting fuel consumption without resorting to reducing the diesel engine's power. The advent of BlueTec® has changed all that. Instead of merely reducing harmful emissions, it goes that all important step further by heralding a clear improvement in the diesel engines' power and fuel consumption too. Consequently, BlueTec® is not just healthy for the environment, it's good for your wallet too.

**New possibilities.** Our customers are the way forward: BlueTec® is available for all Mercedes-Benz truck model series across the whole spectrum of applications: for the Atego, Axor and Actros – from 175 up to 238 kW (129–598 hp). Whatever the category, BlueTec® offers the safest guarantee for the future.

## Benefits at a glance.

- reduced emissions
- lower fuel consumption
- improved power output throughout almost the entire range
- low-maintenance technology
- no additional heat load on the engine
- no reduction of extended service intervals

Progression of Emissions Standards from 1996 – 2011

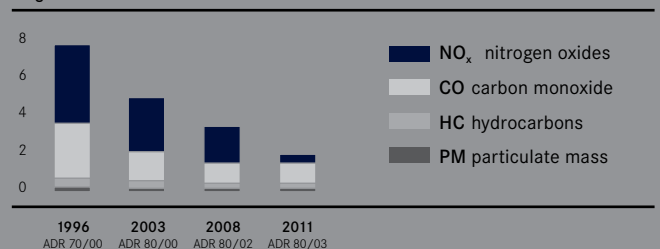

Fewer emissions, more clean air: the evolution of the Emissions Standards between 1996 and 2011 equates to a major reduction in vehicle emissions.



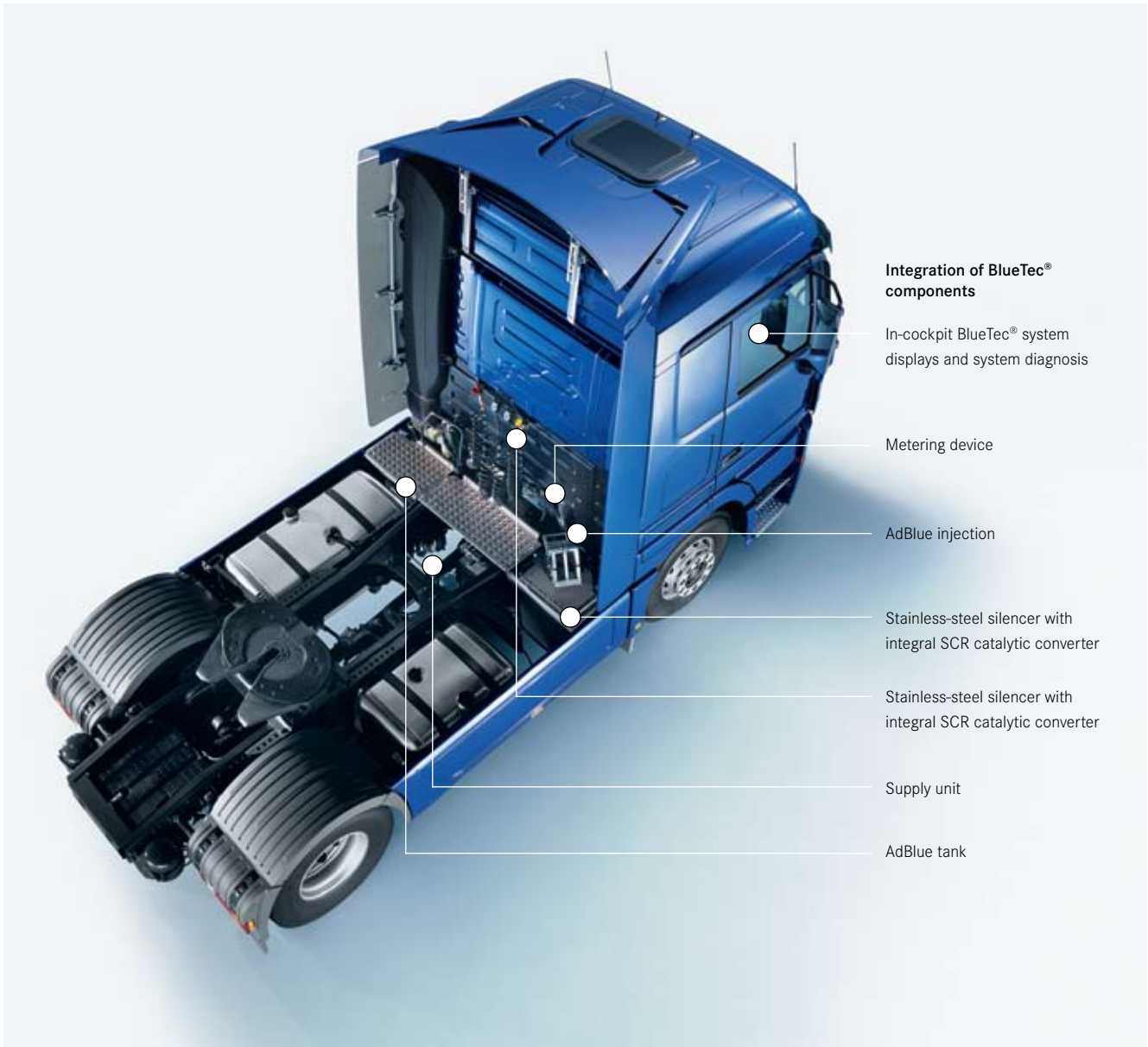

Odourless, non-toxic and simple to refill: that's the additive AdBlue which SCR diesel technology blends with the exhaust flow to reduce the nitrogen oxides in the catalytic converter.

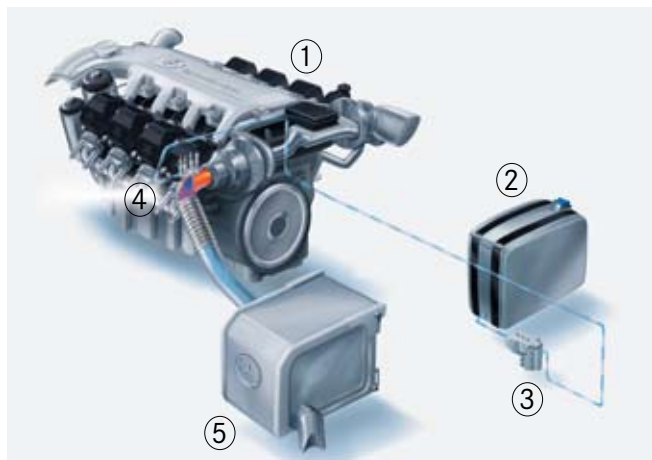

BlueTec® method of operation. ① Engine ② AdBlue tank ③ Supply unit ④ Metering device ⑤ SCR catalytic converter.

# BlueTec® Today's technology for tomorrow's world.

**BlueTec®, the components.** BlueTec® overcomes the challenge of reconciling a reduction in nitrogen oxides and particulate mass with lower fuel consumption using the following components: the redeveloped engine, the additive AdBlue, the supply unit, the SCR catalytic converter and the system diagnosis unit.

**BlueTec®, the method of operation.** The redeveloped engine is at the heart of BlueTec® technology. The increased injection pressure improves combustion, which in turn lowers fuel consumption and the particulate mass. The nitrogen oxides are subsequently converted into harmless substances in the catalytic converter by AdBlue. Operation of the BlueTec® components is monitored at all times by the system diagnosis unit which also keeps the driver informed of the current level of AdBlue in the tank.

**Redeveloped engine.** The redeveloped engine forms the basis for BlueTec®: the increased injection pressure and higher compression ratio make for cleaner combustion, a reduced particulate mass and, depending on the engine variant, added power. The high pressure resistance that these modifications call for is achieved using improved cast-manufactured materials for the crankcase and cylinder head. At the same time, fuel consumption is cut by up to 6% compared to ADR 80/00 vehicles.

**AdBlue.** BlueTec® requires the use of AdBlue, an additive which is fed from the AdBlue tank to the metering device via the supply unit. The supply unit maintains the correct operating pressure for AdBlue which can be refilled at a filling station pump in the same way as diesel. Added to this is the tremendous range of AdBlue: precision metering means that just 1 litre or so of AdBlue is needed for every 25 litres of diesel. The standard-specification AdBlue tank for the Actros has a capacity of 95 litres, for example, which is enough to cover a distance of up to 6,000 km or Melbourne to Cairns and back again.

**AdBlue in the exhaust flow.** AdBlue is injected into the hot flow of exhaust gases through a metering device with high-precision, electronic control. In the heat it reacts to form ammonia, which is required for the chemical reduction of the pollutant in the ceramic SCR catalytic converter.

**Catalytic converter.** Before the exhaust gases are released into the atmosphere, they first pass through the SCR catalytic converter for after-treatment. Here, the nitrogen oxides are converted to harmless substances – nitrogen and water – in a catalytic chemical reaction.

The basis for BlueTec® is the redeveloped engine (1) which is designed for cleaner combustion, a reduced particulate mass and, depending on the engine variant, added power. When the exhaust gas is dispelled from the engine, AdBlue is added. The additive is fed from the AdBlue tank (2) via the supply unit (3) to the metering device (4) which injects it into the hot flow of exhaust gases where it reacts to form ammonia. The SCR catalytic converter (5) and ammonia together convert the nitrogen oxides into harmless substances: nitrogen and water

Progression of Emissions Standards from 1996 – 2011

Euro emissions directive (g/kWh)	ADR 80/00	ADR 80/02	ADR 80/03
Nitrogen oxide	5.00	3.50	2.00
Carbon monoxide	2.10	1.50	1.50
Hydrocarbons	0.66	0.46	0.46
Particulate mass	0.10	0.02	0.02



BlueTec<sup>®</sup> makes its impact felt  
on your bottom line... and on the road.





**The operating cost benefits of BlueTec®.** Fuel consumption accounts for the lion's share of the lifecycle costs in the long-distance haulage sector more than in any other. In the engines that have been developed by Mercedes-Benz for use with the BlueTec® technology, combustion has been optimised to the point where the fuel consumption figures are lower than ever before.

Added to this is the fact that certain engine variants now develop greater power: the V8 engines for the new Actros in particular excel by virtue of their superior pulling power and efficiency, with fuel savings of as much as 6%. Finally, the new drive technology's low-maintenance design brings further cost reductions.

# BlueTec® promises long-term benefits on short-distance routes.

BlueTec® for local distribution, construction site and municipal sectors.



**BlueTec® in day-to-day operation.** Whether it's local distribution, on the construction site or in the municipal sector – every minute counts, making power and acceleration vital. If there's no time to lose, you can rest assured that BlueTec® is the right choice. Thanks to their increased injection pressure, BlueTec® engines do far more than just reduce the particulate mass – depending on the engine variant, power is upped too and fuel consumption reduced by up to 6%. Resistance to wear and robustness are two further areas where BlueTec® excels.

BlueTec® has a low-maintenance design and the drive system can withstand even the toughest conditions. These are the ideal credentials for uninterrupted above all trouble-free operation, and for a healthy balance sheet. All in all, an impressive set of benefits that produce tangible cost savings as well as increased reliability.

Wherever you are headed, whatever you are transporting: BlueTec® will give you peace of mind, both ecologically and economically speaking.





BLUETEC 5

Atego

919

S DC 818



**BLUETEC**

# Progress needs a driving force. So take your pick.

Atego 6-cyl. in-line

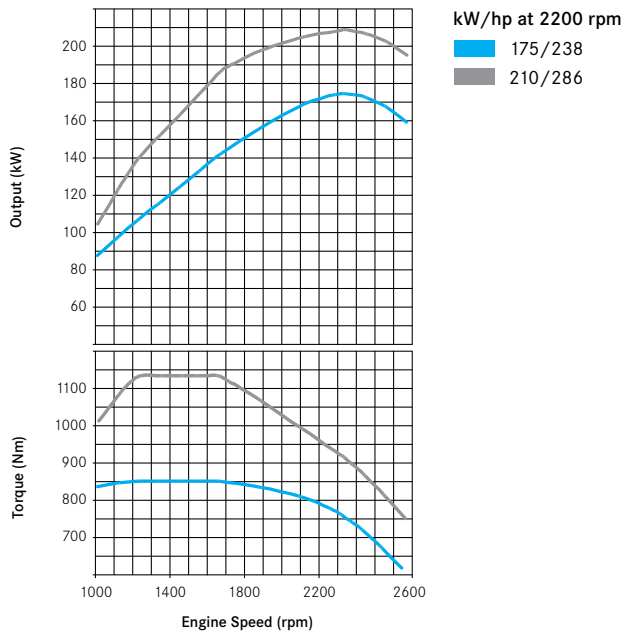

Axor 6-cyl. in-line

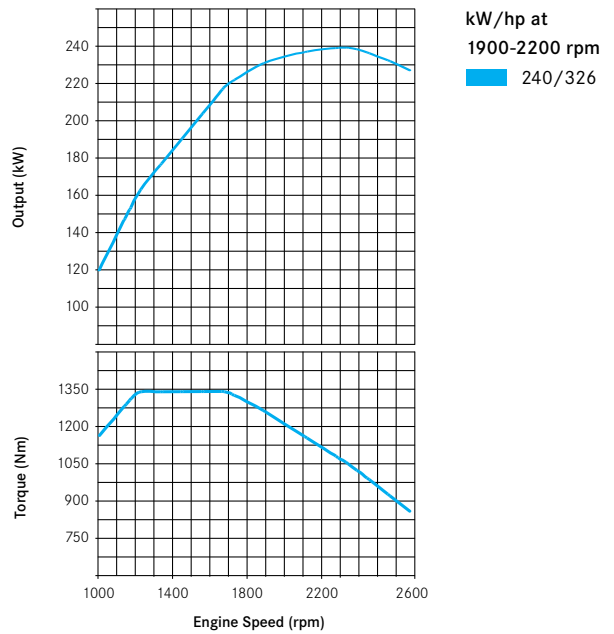

Actros V6

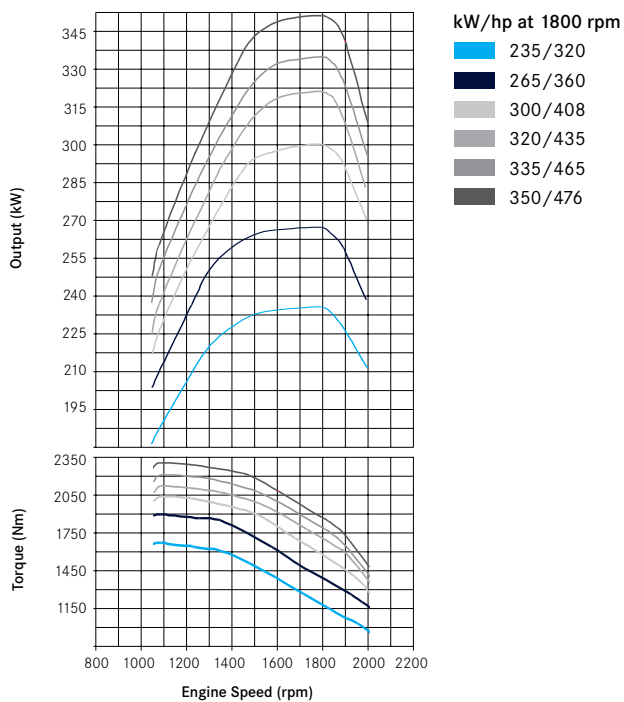

Actros V8

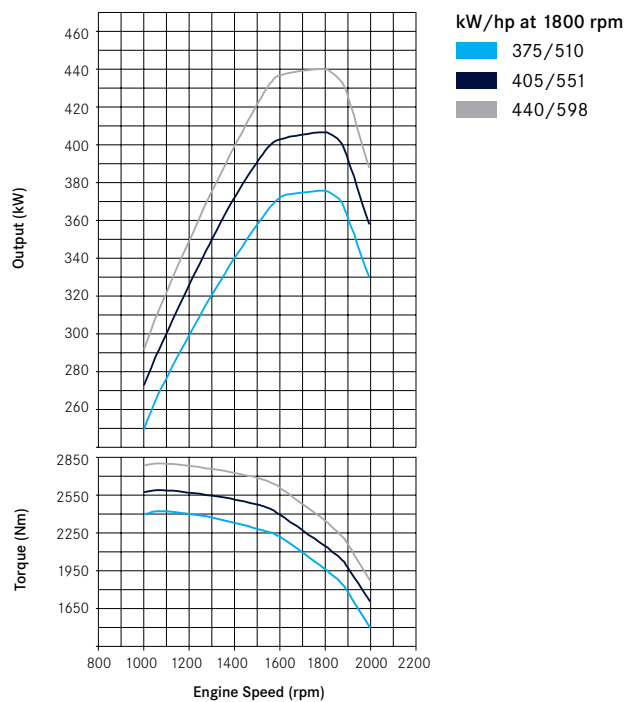



**Please note:** changes may have been made to the product since this brochure went to press (01.05.2007). The manufacturer reserves the right to make changes to the design, form, colour and specification during the delivery period, provided these changes, while taking into account the interests of the vendor, can be deemed reasonable with respect to the purchaser. Where the vendor or the manufacturer uses symbols or numbers to describe an order or the subject of an order, no rights may be derived solely from these. The illustrations may show accessories and items of optional equipment which are not part of standard specification. Colours may differ slightly from those shown in the brochure, owing to the limitations of the printing process. It provides a general indication of the range of models, features, optional extras and/or colours available in Australia. Some of the models, features, optional extras and/or colours shown may not be available in your country or may only be available in a different specification. Additionally some models, features, optional extras and/or colours may only be available in combination with others. For current and more specific information in relation to the range of models, features, optional extras and/or colours available in Australia, and their pricing, you should contact your authorised Mercedes-Benz Truck Dealer, on 1300 66 22 30 or go to [www.mercedes-benz.com.au/trucks](http://www.mercedes-benz.com.au/trucks)

BlueTec® is a registered trademark of Daimler AG. Daimler AG, Stuttgart VL/MC 6360 - 0563 - 02- int -00/0409 DC\_BRO\_344. MBB006 07/09

Your authorised Mercedes-Benz Dealer is: