

This Brochure is prepared by Daimler AG and it predominantly reflects the capabilities and performance of vehicles sold in Europe. Some characteristics, capabilities, performance features and optional extras (e.g. towing systems) may not be available or may not apply in Australia or under Australian conditions. The information in this Brochure is therefore indicative, illustrative and provided only for guidance and should not be relied on. To obtain current and accurate information on a vehicle and any options applicable to Australia, contact your local authorised Mercedes-Benz dealer.



Mercedes-Benz



The B-Class



Mercedes-Benz

“Our philosophy is very simple. We give our best for people who expect the best.”

Dr Dieter Zetsche

# Contents

<b>The B-Class</b>	<b>3</b>	<b>My B-Class</b>	<b>46</b>
<b>Exterior design</b>	<b>4</b>	<b>Equipment</b>	<b>46</b>
<b>Agility</b>	<b>14</b>	COMAND APS	46
BlueEFFICIENCY	14	Interior comfort	48
B-Class F-CELL	20	Surround sound system	54
Petrol engines	22	Sports package	56
Diesel engines	24	Exterior Chrome package	60
AUTOTRONIC	26	Standard equipment	62
<b>Safety</b>	<b>28</b>	Optional extras	64
Integral safety concept	28	Light-alloy wheels	66
<b>Comfort</b>	<b>34</b>	designo	68
Space and variability	34	Genuine accessories	70
EASY-VARIO system	36	<b>Services</b>	<b>72</b>
Interior design	38	<b>Colours and materials</b>	<b>76</b>
Audio and communication systems	42	Upholstery, leather and trim	76
Driver assistance systems	44	Paintwork	79
Light and Sight package	45	<b>Technical data</b>	<b>77</b>

# Designed to fit your life. The B-Class

Contradictions provide the dynamic behind all movement – and the trigger for unconventional ideas. How do you go about developing a compact car with as much interior space as possible? How do you achieve the optimum balance between ride comfort and sporty handling? How can a vehicle be practical and elegant at the same time? The

B-Class provides a refreshing answer to all these questions by combining the best qualities of a range of different concepts. The result is a sports tourer with an exciting design and a degree of versatility that sets it apart from the rest of its class.

Sensibly sensuous









## The B-Class: lines that rewrite the rules

Despite its compact exterior dimensions, the B-Class is big on looks and practicality. The exceptional character of its underlying concept is reflected in its striking design. The transition from the bonnet to the wide radiator grille takes the form of a dynamic

wedge with large air intakes in the bumpers and flared wheel arches underlining the sporty design idiom. Large exterior mirrors optimise visibility and are finished in the vehicle colour as standard.





## Aesthetically speaking, the design of the tail end is way out in front

The B-Class also makes an attractive impression when viewed from behind, the elegant rear bumper being a particularly striking feature. The short aerial integrates perfectly into the sporty design of the B-Class.

At the same time, the rear lights impress with their high-brilliance look. And with a brilliant

idea – the adaptive brake lights which are a standard feature of the B-Class. During emergency braking from speeds in excess of 50 km/h, the brake lights flash several times a second to warn following vehicles. And if the vehicle is braked to a standstill from at least 70 km/h, the hazard warning lights are activated automatically as an additional safety measure.





## The compact car that's endlessly impressive

A look at the purposeful front of the B-Class tells you plenty about its personality. Sporty and elegant chrome trim is used for the three large louvres of the radiator grille. If you choose the optional Exterior Chrome package or the Sports package, the radiator grille is painted in attractive brilliant silver matt instead of the standard atlas grey. Large, distinctive air intakes and a harmonious transition from the bonnet to the bumper covering are further signature elements

of the B-Class. The optional front fog lamps now have an even more stylish look thanks to their chrome surrounds. With the Sports package, the chrome surrounds are complemented by a horizontal fin with a chromed edge. As well as looking extremely cool, the B-Class can provide a particularly refreshing travelling environment for its occupants thanks to the optional panoramic louvred sliding sunroof, whose transparent panels can be opened at the touch of a button.

## BlueEFFICIENCY – fast forward to tomorrow

We are quicker at getting environmentally friendly future technologies to where it matters most: on the road. As the inventor of the motor car, Mercedes-Benz has a special responsibility – one we have undertaken with all our might for many years. By the end of 2010, we will be able to offer you over 85 models with BlueEFFICIENCY technologies, all of which place far less of a burden on the environment – without compromising on safety, comfort and driving enjoyment.

Our BlueEFFICIENCY concept comprises innovations for efficient mobility as well as optimised processes all the way along the value chain. They involve different approaches, but they all have a common goal: to make your individual mobility as sustainable as possible.

**The BlueEFFICIENCY measures – the Mercedes-Benz efficiency package.** This package consists of comprehensive vehicle optimisations designed to save fuel and ease the burden on the environment. Each model combines the most

efficient engine with latest-generation aerodynamic and energy-management measures to minimise fuel consumption. Such measures include intelligently controlled ancillaries, tyres with optimised rolling resistance, lightweight components and the ECO start/stop function, which is being made available for an increasing number of models. The new BlueDIRECT V6 and V8 petrol engines in the S-Class, CL-Class and CLS-Class, for example, reduce fuel consumption by up to 24% yet have a much higher power output.

**BlueTEC – the clean diesel.** Mercedes-Benz has brought to market BlueTEC technology for diesel engines based on common-rail direct injection (CDI). A modular emission-control system makes BlueTEC an exceptionally clean diesel technology, as not only does it remove up to 95% of the particulate from the exhaust gases, it also reduces nitrogen oxides by up to 90%. All that remains is essentially water, harmless nitrogen and the satisfying feeling of having helped to ease the burden on the environment.

**HYBRID – the intelligent combination of petrol and electric drive.** A well-established team makes a lot of things easier. And this is certainly true in the case of HYBRID technology. Here the electric motor is used for the recuperation of braking energy, which is stored in the battery. When needed, this energy is returned to the electric drive, which assists the petrol engine when the car is accelerating. What's more, the ECU shuts off the petrol engine when the speed falls below 15 km/h. In this way, a HYBRID can reduce fuel consumption by up to 20%. So it looks



The BlueEFFICIENCY measures bring about a substantial reduction in fuel consumption and CO<sub>2</sub> emissions





after the environment as well as your bank balance. Perfect teamwork, you might say.

**BlueTEC HYBRID – clean diesel combined with electric drive.** It marries the benefits of the HYBRID with those of BlueTEC: during braking, the kinetic energy is converted into electrical energy, which can be re-used when required. At the same time, the BlueTEC technology cleans the exhaust gases and removes many of the pollutants. All of which makes the economical diesel powerplant even more efficient, agile and clean.



Taking the E-Class as a basis, we are using **BlueTEC HYBRID technology** to develop the first diesel hybrid in this class

**Innovative drive systems that break new ground: E-CELL and F-CELL.** Mercedes-Benz has developed these two locally emission-free drive systems. The B-Class F-CELL is already being produced on a small scale and has been displaying its everyday practicality on Germany's roads since mid-2010. It uses hydrogen to produce power for the electric motor in a fuel cell. The first models from a small series of the A-Class E-CELL – featuring an electric motor which draws its energy from two lithium-ion batteries, giving it an average range of more than 200 km –



The A-Class **E-CELL** allows locally emission-free driving with a battery-powered electric motor

will start to roll off the production line at the end of 2010. There will also be an E-CELL PLUS, which will include a small internal combustion engine (Range Extender) to increase the range of the electric vehicle.

But that is not all: under the banner “Design for Environment”, we also look at a vehicle's entire lifecycle and work hard to preserve the environment from the planning stage right through to recycling. The same applies to the building and running of new plants. In addition, we are heavily involved in the development of alternative fuels and carry out research in the field of bionics. In short, BlueEFFICIENCY is good news for both you and the environment.

Further information about our comprehensive measures can be found at:

[www.mercedes-benz.com/blueefficiency](http://www.mercedes-benz.com/blueefficiency)



## When you stop, the environment gets a boost



The B-Class B 160 BlueEFFICIENCY and B 180 BlueEFFICIENCY models have been developed to minimise energy consumption. This is precisely what BlueEFFICIENCY stands for – a concept comprising numerous vehicle-optimisation measures such as tyres with low rolling resistance, intelligent alternator management and an energy-efficient steering system. These measures help to reduce fuel consumption by up to twelve percent and CO<sub>2</sub> emissions by a substantial margin. As does another key component of the BlueEFFICIENCY system: the ECO start/stop function allows you to save fuel when the car stops at traffic lights or is stuck in a jam, further easing the burden on the environment.

The function can detect when the engine is not needed, and automatically switches it off. As soon as you fully depress the clutch the engine starts again – so quickly and quietly that you hardly notice a thing. But it's not just the emissions caused during driving that we were able to reduce – we tackled those arising during the manufacturing process too. The B-Class contains recyclable materials like steel and light alloys, and renewable raw materials such as coconut fibres in the seats. All the B-Class models have received the South German Technical Inspection Authority's<sup>1</sup> Environmental Certificate.

<sup>1</sup> South German Technical Inspection Authority – TÜV SÜD Management Service GmbH, Munich

## Now you really can step on the gas

Protecting the environment pays – in more ways than one. That's because, by using natural gas as a fuel, you are cutting not only your pollutant emissions, but also your refuelling costs. The B-Class B 180 NGT BlueEFFICIENCY model runs on both petrol and natural gas. Just press a button and you switch from one mode to the other –

even while on the move. This setup has economical and ecological advantages: natural gas can be used as a fuel without any processing which would in itself be environmentally damaging. In natural-gas mode there are no particulate emissions and the amount of CO<sub>2</sub> released is about 23% lower than in petrol mode.



The fuel gauge in the B 180 NGT BlueEFFICIENCY



The two-part fuel tank assembly

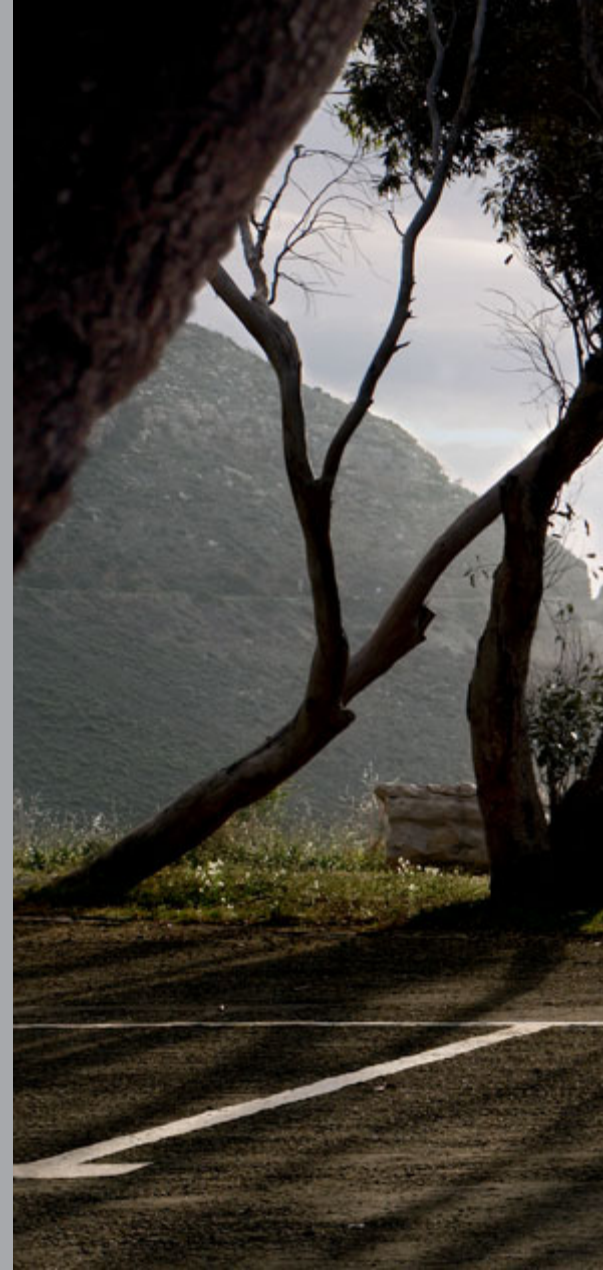



11111



NGT

S 0U 4366



F-CELL

BlueEFFICIENCY

zero emission  
CO<sub>2</sub>: 0,0g/km

zero emission

S 13 231

# Hydrogen – tomorrow’s fuel today

The B-Class F-CELL with a fuel cell drive system

Mercedes-Benz aims to build cars that generate zero emissions. We are closer to achieving this than many might think. Over a hundred prototypes with a fuel cell drive system have already clocked up more than 4.5 million kilometres worldwide. The B-Class F-CELL needs no mineral fuels such as petroleum or diesel whatsoever.

The energy is generated from a chemical reaction between hydrogen and oxygen. The result is that only steam is emitted from the exhaust pipe. 2010 saw the first vehicles handed over to customers while the series-production version of the B-Class F-CELL is set to roll off the production line within a few years. Mercedes-Benz is also collaborating

with a host of power utilities as well as government to obtain large quantities of hydrogen from renewable energy sources such as the sun, wind or biomass over the long term, thus ensuring that emission-free motoring will soon become a reality.



The B-Class F-CELL refuels with hydrogen



The energy flow display in the B-Class F-CELL

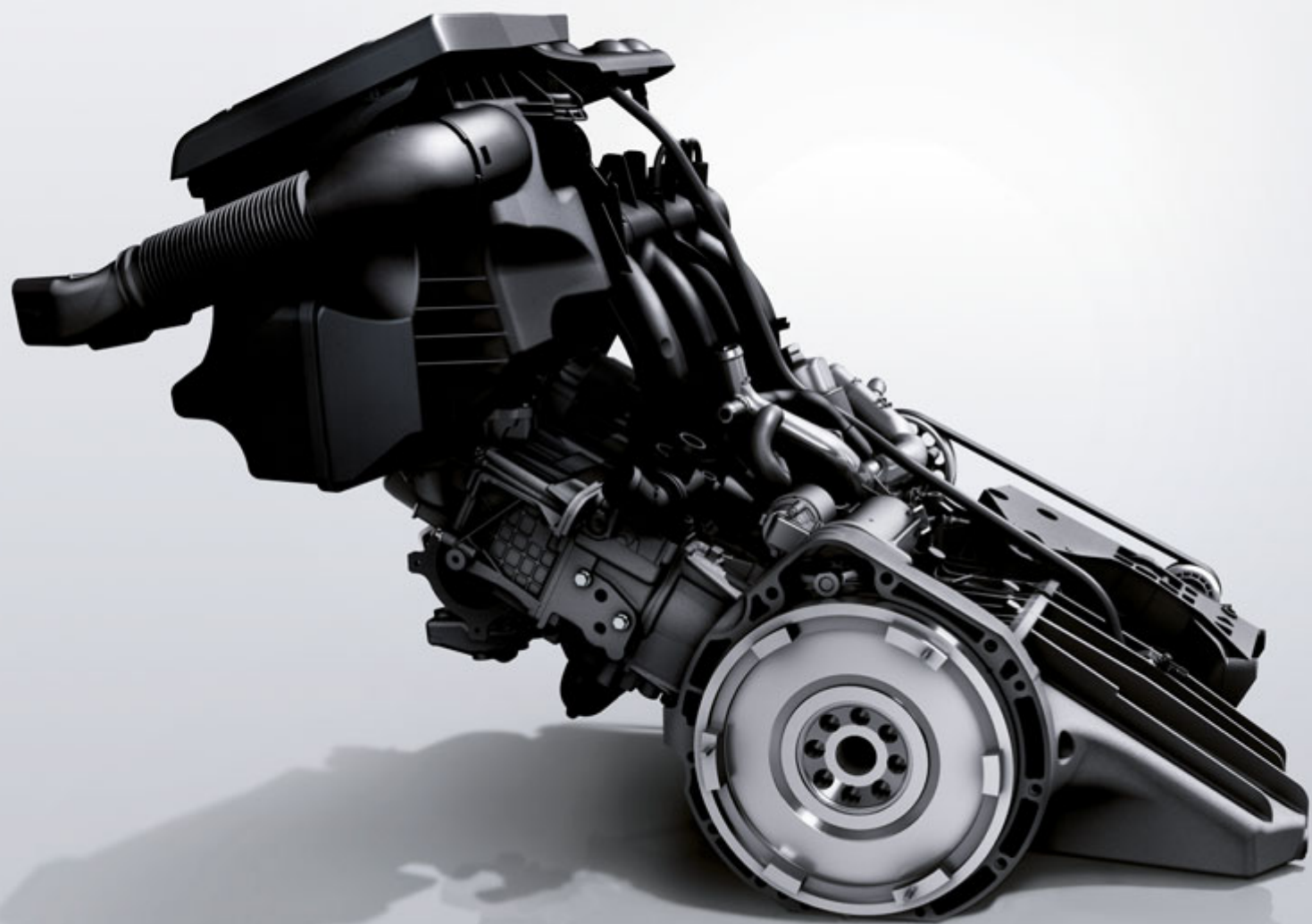



# Where fuel goes further

Despite its highly agile character, the B-Class consumes petrol remarkably sparingly as it eats up the miles. This is principally due to the advanced design of our petrol engines.

Their strength lies not just in the performance they deliver, but also in the economical and

environment-friendly way in which they do it. Low friction losses and an optimised combustion process help to reduce fuel consumption and emissions (details of fuel consumption and CO<sub>2</sub> emissions can be found on pages 77 and 78). The B 200 at the top of the engine range, which has an output of 100 kW and 185 Nm of

torque at 3500 to 4000 rpm, attains a top speed of 196 km/h. Of course, the two other petrol models – the B 160 BlueEFFICIENCY and B 180 BlueEFFICIENCY – can also be counted on to deliver dynamic driving pleasure while keeping fuel consumption down.

B 200

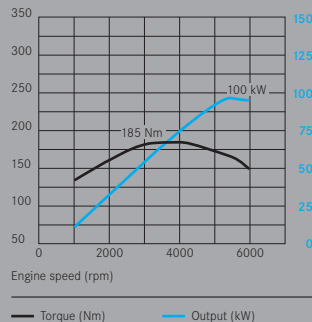

The B 200 reconciles effortless performance and economy

# Clean up with a smart investment

With the pressure on to deliver clean diesel powerplants, our engineers have adopted high-pressure common-rail technology. In both diesel engines available for the B-Class, the fuel is atomised as it is injected into the combustion chambers under high pressure in precisely calculated quantities across the entire engine speed range.

As well as reducing fuel consumption and pollutant emissions, this engine design ensures a high level of torque. With up to 250 Nm from the B 180 CDI (80 kW) and as much as 300 Nm from the B 200 CDI (103 kW), you can count on an enjoyable driving experience with plenty of pulling power. As you would expect, both diesel

units are equipped as standard with a particulate filter. What you might not expect, however, is that the special design of the filter system ensures that it performs to an even higher standard than that called for by current emissions regulations.

B 180 CDI

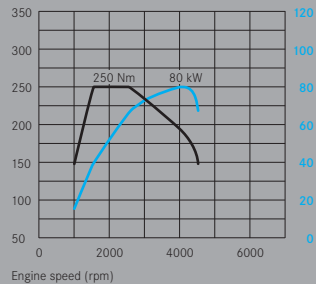

B 200 CDI

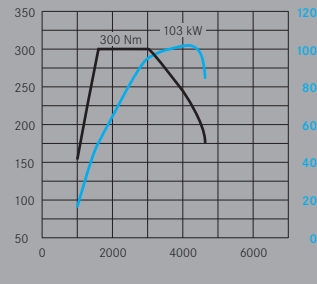

Engine speed (rpm)

— Torque (Nm) — Output (kW)

Equipped with common-rail technology, both engines deliver high torque even at low revs

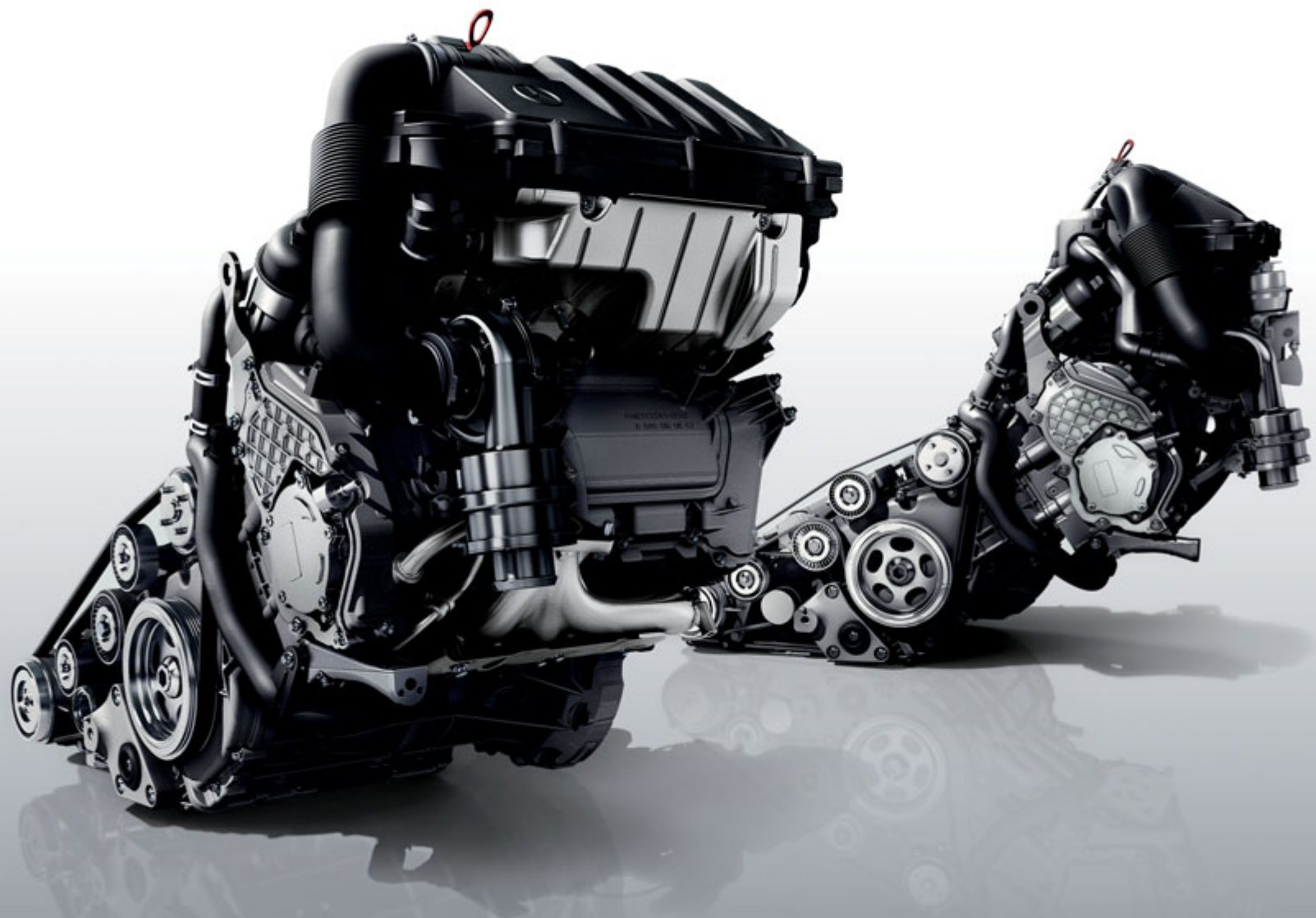

## The only thing you should feel when accelerating is acceleration

The long wheelbase and the particularly wide track of the B-Class help to reconcile good driving dynamics with the highest possible degree of comfort. These qualities can be enhanced even further with the optional automatic package comprising the AUTOTRONIC continuously vari-

able automatic transmission and cruise control with SPEEDTRONIC. AUTOTRONIC recognises your own personal driving style and adjusts the engine speed accordingly. Thanks to the continuously variable adjustment of the transmission ratio, the vehicle accelerates without any inter-

ruption to the power delivery. By nudging the selector lever or pressing the optionally available steering-wheel gearshift buttons, you can also change manually between the virtual gears – for an even sportier drive.



Continuously variable automatic transmission: selector lever



The optional steering-wheel gearshift buttons



# Anticipation is part of safe driving. It's also part of the B-Class

Every accident is an accident too many. That is why the B-Class is equipped with numerous active safety features designed to help prevent accidents from occurring in the first place. To stabilise the vehicle when there is a risk of understeer or oversteer developing, for example, the standard-specification Electronic Stability Program ESP® can apply the appropriate

braking force to one or more wheels and adjust the engine output if necessary. The STEER CONTROL steering assistance system is also a great help. This applies a distinct impulse to the steering wheel in order to help the driver countersteer in the correct direction. The active safety features also include the standard-fit Brake Assist (BAS) which can recognise emer-

gency braking by the speed with which you press the brake pedal. In a fraction of a second it builds up the maximum braking force, thereby reducing the stopping distance. The tyre pressure warning system and acceleration skid control ASR are also fitted as standard.

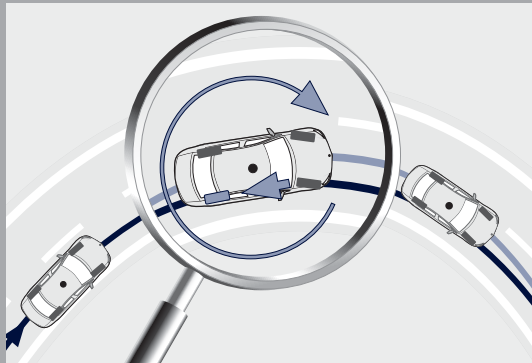

ESP®: brake application in the event of understeer

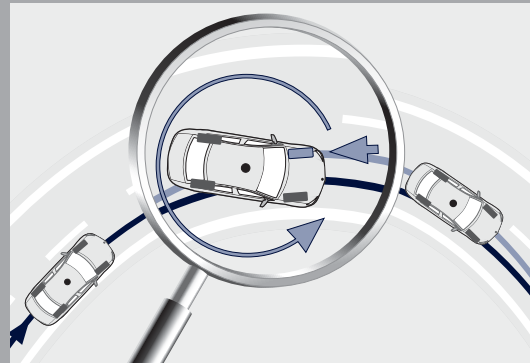

ESP®: brake application in the event of oversteer





B100



S 0V 8529



## The B-Class keeps you out of harm's way

The B-Class protects the driver and all the occupants with state-of-the-art safety technology which can help prevent accidents from occurring in the first place while also offering a very high degree of protection in the event of a crash.

The optional bi-xenon headlamps provide brighter illumination than conventional headlamps. And the active light function also offers visible benefits by following your steering movements as you drive, thus ensuring the best possible illumination even on winding roads. Our safety engineers are specialists in the development of intelligent

solutions which can save the day, such as the large number of airbags situated at key points and designed to protect you in the event of an impact. The adaptive airbags for the driver and front passenger can even be triggered in two stages. Sensors can forecast the severity of the impact and, if necessary, trigger just one stage or both. Additional occupant protection is provided by head/thorax sidebags or the optional combination of sidebags and windowbags. So you're not the only one who is safer on the road; all your passengers are, too.

# You can count on us to do our best if the worst comes to the worst

Sitting in the B-Class, you are surrounded by numerous active and passive safety systems which have been designed to complement each other. Our integral safety concept represents the state of the art – as you would expect in a Mercedes-Benz. As well as providing better all-round visibility, your raised seat position offers a high level of safety in a frontal collision: thanks to their special installation position, the engine and transmission are able to slide down along the angled pedal floor below the passenger compartment, significantly reducing the risk of injury to the occupants. Crash-responsive emergency

lighting is also fitted as standard. In the event of an accident situation in which the system detects that pyrotechnic restraint systems such as the airbags or belt tensioners are triggered, the hazard warning lights are switched on, as is the interior lighting if the latter is set to automatic mode. In vehicles equipped with the optional Light and Sight package, the footwell lighting is also activated. So even after an accident, the safety systems of your Mercedes-Benz are designed to help you find your bearings again and to make it easier for rescuers to come to your aid.





# Variability is a constant

The B-Class: a quick-change artist *par excellence*

The B-Class is a space sensation. Even with rear passengers on board there is an astonishing amount of boot space available: with a loading length of 89.8 cm and a capacity of 544 litres, there is enough room for at least six large bottle crates, for example. Even the B-Class F-CELL and B 180 NGT BlueEFFICIENCY models boast an impressive load-compart-

ment capacity of 416 litres, not to mention a flat boot floor thanks to intelligent housing of the additional components and gas bottles. What's more, the standard-equipment package includes 1/3 : 2/3 split-folding rear seats. And all the rear seats can be folded down easily to create a completely flat load area.



The spacious load compartment



The optional folding and removable rear armrest with cup holder

## Designed to fit your requirements, not a pigeon hole

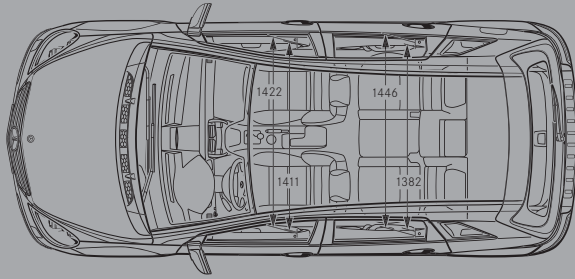

Whatever you need to carry, the outstanding variability of the B-Class means that the ideal interior layout can be configured quickly and easily. And with the optional EASY-VARIO system, the backrest of the front passenger seat can be folded forward or the rear backrests and the front passenger seat can be removed entirely with effort-less ease. The result is a flat load area measuring up to 2.95 metres in length and offering a load capacity of

up to 2245 litres – approximately equivalent to the contents of 18 fully loaded shopping trolleys. The optional rear centre armrest can be folded or removed completely to create an ideal through-loading facility for long, bulky objects such as skis in next to no time. The luggage compartment is equipped as standard with stowage facilities providing additional quickly accessible storage space for small items.

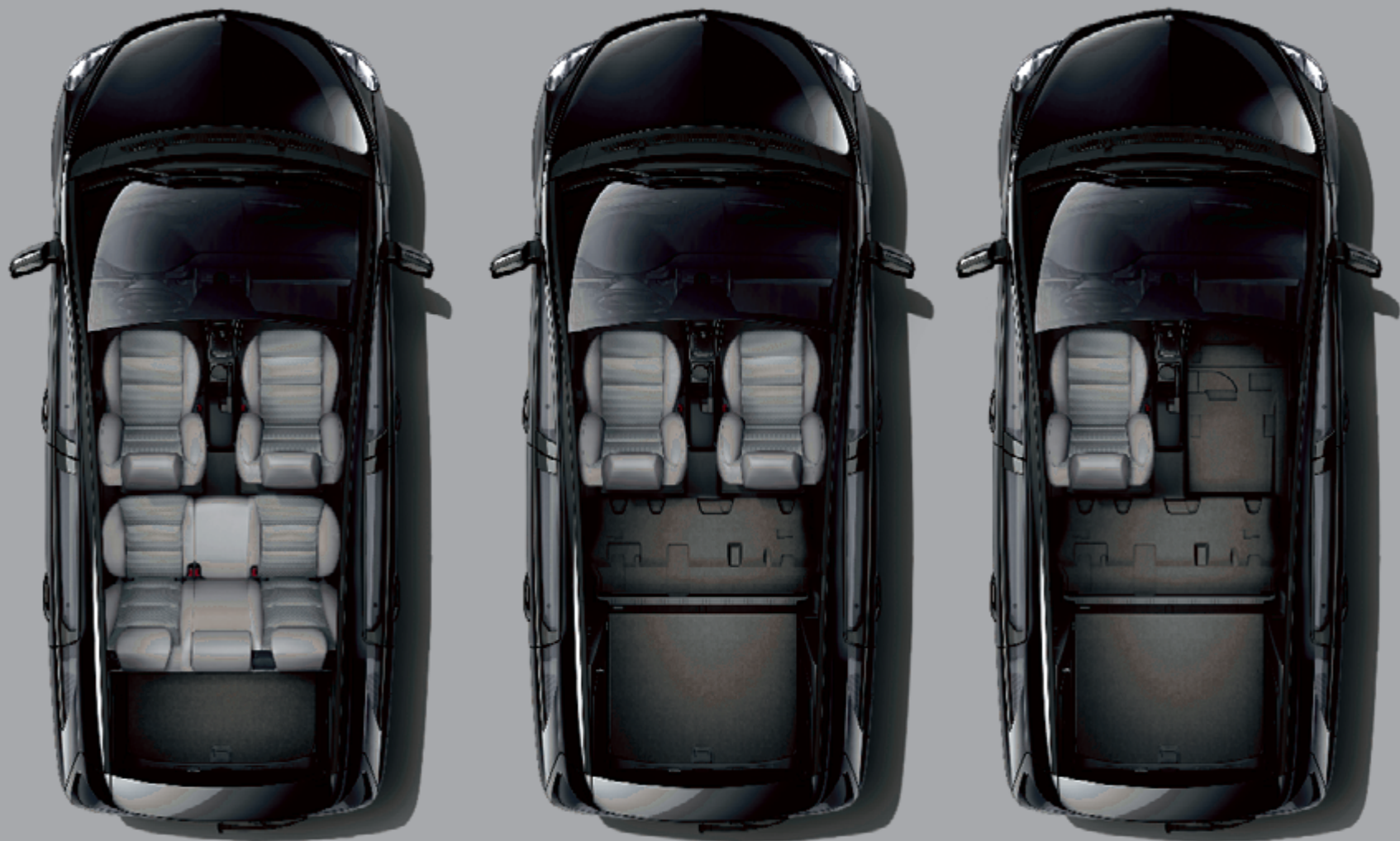

The B-Class offers you a variable interior with a load area length of up to 2.95 metres





# The interior: a great place to break your journey

The B-Class takes passenger accommodation to new heights in this category – and not just because the raised seat position makes getting in particularly comfortable. Superb materials of the highest quality and a dynamic design idiom give the interior a particularly exclusive ambience. The stylish touches include the sporty aluminium finish of the trim on the centre console and on the door linings. As an option, these elements can be ordered with fine myrtle wood instead.

But aesthetic qualities were only one of the factors taken into account in the design of the interior. Particular attention was also paid to ergonomics, a case in point being the clearly laid out dashboard with its fine chrome trim. The steering wheel can be adjusted for height as well as

reach in order to allow it to be positioned optimally for virtually every driver. The numerous stowage facilities are a particularly practical feature of the B-Class. Optional stowage boxes under the front seats, a stowage compartment in the centre console and a spectacles case above the driver's door ensure that everyday oddments can be stowed quickly and easily.

Even the glove compartment can be cooled by the air conditioning system so that you can enjoy refreshing cold drinks en route. And with the optional THERMOTRONIC luxury automatic climate control, separate temperatures can be set for the driver and front-passenger sides.



The air-conditioned glove compartment



The optional stowage box beneath the front passenger seat



## Everyone travels 1<sup>st</sup> class

The B-Class has what it takes to make every trip a good one. Despite the vehicle's compact exterior dimensions, the interior offers plenty of space. Groningen fabric - in orient beige, black or alpaca grey - is the standard upholstery for the comfortable seats. As an option, you can order the high-quality combined ARTICO man-made leather/Bastogne fabric upholstery which also forms part of the Sports package. Then again, you can equip the B-Class with fine leather appointments. Standard trim in brushed aluminium creates a distinctly elegant look. When it comes to choosing the ideal seat position, no-one knows better than you - which is why the driver's seat includes a height adjustment function as standard. If you choose the optional Seat Comfort package, the front passenger seat is also adjustable for height. Also included in the package are a seat cushion angle adjustment function and lumbar supports for the driver and front passenger.



PASS AIR BAG

RADIO DISC  
NAVI TEL  
SYS

1 Q.W  
2 ABC  
3 DEF  
4 GHI  
5 JKL  
6 MNO  
7 PQRS  
8 TUV  
9 WXYZ



Navigation control buttons: back, search, home, cancel



MAX OFF 21° 21°



REAR

A/C

# Everything you need for cruising the data highway

Equipment for the B-Class includes a wide range of optional audio and communication systems, a number of which bring together various different functions. The optional COMAND APS multimedia system, for example, not only allows you to control the radio, CD and DVD player, but also provides a user-friendly interface for a mobile phone and the integral navigation system. The navigation function of COMAND APS and the optionally available Audio 50 APS uses DVD/hard-disc storage only, so it is possible to store particularly large quantities of navigation data and process them at a considerably faster

rate. The optional media interface allows you to connect devices such as your MP3 player, your iPod® or external hard discs. The iPod® can be controlled extremely conveniently from the steering wheel and via the Audio 20/50 APS system or COMAND. An SD card slot for MP3 and WMA music files is included in the scope of the optional COMAND APS system.

The voice-operated control system LINGUATRONIC also brings distinct benefits. Its extended voice-control technology and many other practical functions are literally the last word in convenience.



The voice-operated control system LINGUATRONIC

# Allow us to introduce your assistants

Even when you are alone in your B-Class, many useful helpers travel with you. You can simply let the car help you park, for instance – with the optionally available Active Parking Assist. Once the car has detected a parking space, you can engage reverse gear and confirm that you want to park. Then all you need to do is control the car's speed with the accelerator and the brake pedal. The system turns the steering wheel automatically, and in next to no time the car is parked parallel to the direction of travel.

Another highly practical aid is Hill-Start Assist, which makes it much easier to set off on a gradient and prevents the vehicle from starting to roll unintentionally when you move your foot from brake pedal to accelerator.

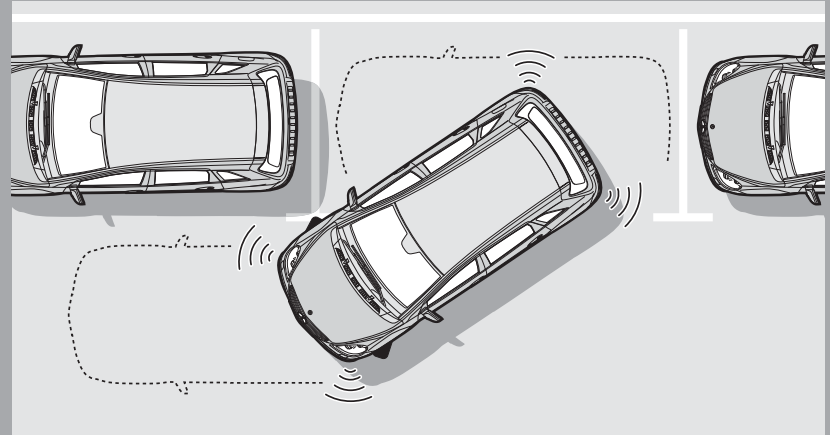

Active Parking Assist: how it works

# Seeing and being seen

The optional Light and Sight package is a glowing example of the superior comfort and convenience offered by the B-Class. Its line-up of bright ideas comprises: two reading lights in the rear and an additional reading light for the driver, sun visors with illuminated vanity mirrors, front footwell

lighting as well as entry/exit and signal lights in the front doors. Other highlights of this equipment package include the automatically dimming interior mirror, rain sensor, headlamp switch-off delay and locator lighting.



The Light and Sight package



The automatically dimming interior mirror with rain sensor





# Ergonomics – the right look and feel

The optional COMAND APS multimedia system offers numerous functions for outstanding in-car entertainment. The large central colour display is the control interface not only for the navigation system, but also for the radio, CD player, mobile phone and SMS functions. What's more, three years of free navigation data map updates are included (updates start from date of initial vehicle registration and are associated with the vehicle). A navigation system is also integrated in the optional Audio 50 APS radio. As both systems only use DVD or hard-disc storage they are significantly faster than comparable CD-ROM-based units.

Special features of the navigation system include TMC dynamic route guidance (provided with COMAND APS TMC Pro), which guides you around traffic jams, and the standard trip computer in the instrument cluster. This displays data such as the average fuel consumption or the distance covered. Fitted as standard, the multifunction steering wheel puts everything at your fingertips. It can be adjusted to any position and its buttons allow you to control a large number of vehicle functions while you keep your hands on the wheel and your eyes on the road.



The COMAND APS multimedia system

## You'll only know it's a long journey if you look at the mileage reading

“Please take your seats.” Even rear passengers will be happy to accept this invitation in the B-Class. The three rear seats are comfortable even on longer trips. And when it comes to carrying small children, the B-Class is equipped as standard with ISOFIX child seat attachment points with TopTether in the rear. This standardised system offers a particularly high level of safety thanks to its ease of use and the fact that the child seat is attached directly to the vehicle body. For children aged six or above, child seats integrated into the rear seats are available as an option.

Large side doors front and rear make getting in and out straightforward. At the front, they open to reveal fine door sill panels with “Mercedes-Benz” lettering. They underline the sporty and elegant character of the B-Class, as does the high-quality door panelling. These attributes can be brought

out to even greater effect with the optional leather appointments which are available in alpaca grey, black or orient beige.



The high-quality interior materials





# Improve your outlook

## Panoramic louvred sliding sunroof

If you would like to see something of the world, the optionally available panoramic louvred sliding sunroof is ideal. A touch of a button is all that is required to secure your place in the sun. On opening, the front louvre tilts upwards into the ventilation position where it acts as a wind deflector while the other four louvres can be slid back to any position you like. Because the louvred sunroof opens significantly wider than conventional sliding sunroofs, your B-Class has the authentic feel of a cabriolet. You can even

enjoy it on the days when the sun refuses to shine: the scratch-resistant transparent surface of the panoramic roof gives you an uninterrupted view of the sky while protecting you from the weather. Once you have seen enough, you can simply close the manually operated twin roller blind which provides protection from the sun when the panoramic louvred sliding sunroof is closed and serves as a wind deflector when the roof is open.



## Comfort is also a question of climate

An ideal travelling environment thanks to THERMATIC and THERMOTRONIC

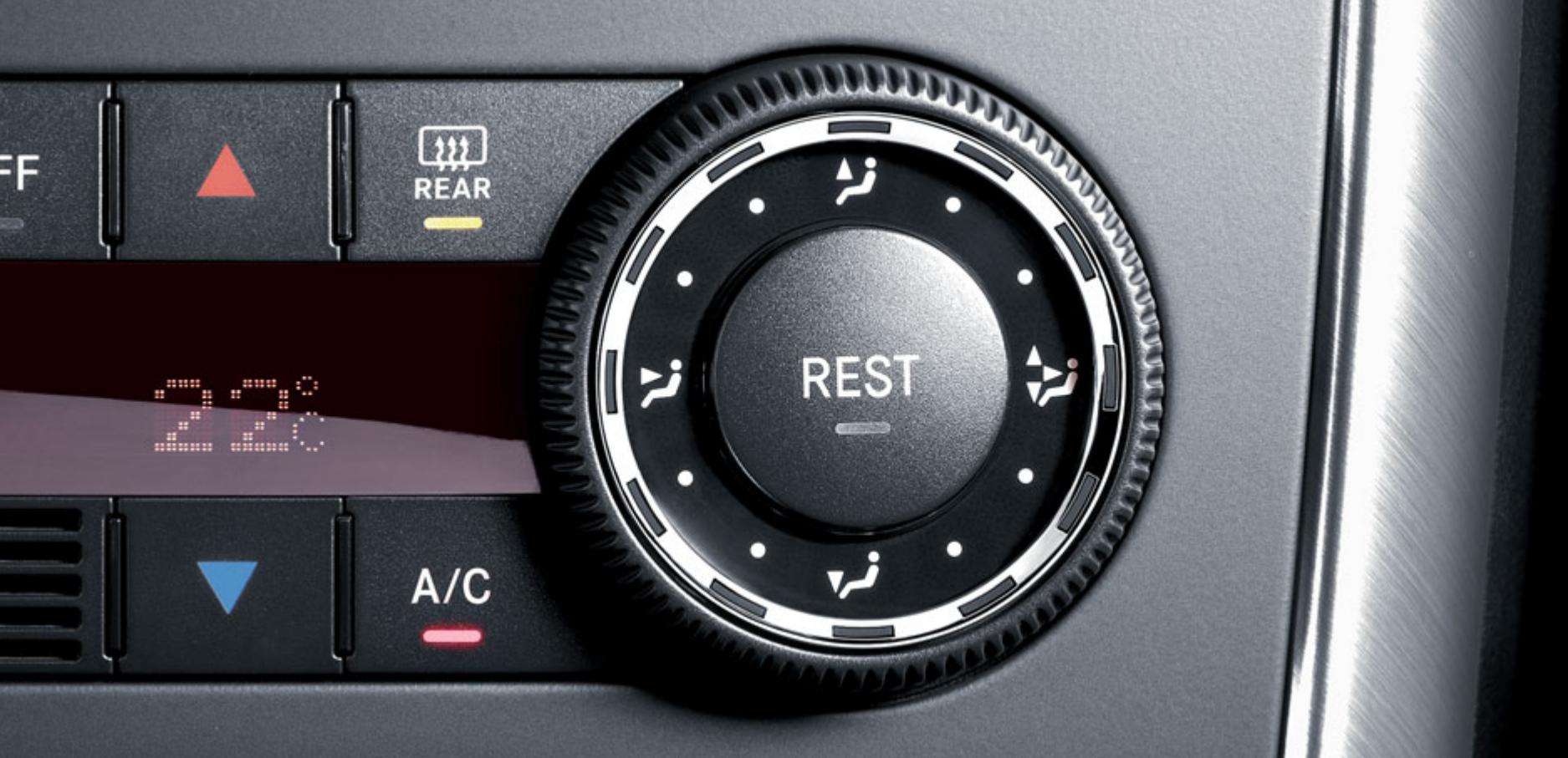

Wherever you go in the B-Class, you'll always be in the comfort zone thanks to the standard-fit THERMATIC automatic climate control which has five settings ranging from a cool breeze to a refreshing wind. The optional THERMOTRONIC

luxury automatic climate control goes even further by allowing the driver and front passenger to set their own preferred temperatures independently. Exterior conditions, such as temperature and humidity as well as the intensity and angle

of incidence of the sun's rays are also taken into account. THERMOTRONIC has a residual engine heat utilisation function as well.

# Loud and clear

## The Harman Kardon® Logic 7® surround sound system

You can also enhance the interior of the B-Class with a rich tapestry of sound. With twelve high-performance loudspeakers, the optional Harman Kardon® Logic 7® surround sound system ensures authentic listening pleasure and excellent sound quality whether it is playing standard stereo tracks or (in conjunction with the COMAND APS multimedia system) Dolby Digital 5.1 recordings.

The advanced sound reproduction capability of the Logic 7® multi-channel, three-dimensional

sound technology and a 9-channel DSP amplifier turns your B-Class into a concert hall. The higher output of 450 watts ensures that there is plenty of power in reserve to deliver a rich, full sound. A suitably extensive supply of music can be provided by the optional media interface. This can be used to connect to your MP3 player<sup>1</sup>, your iPod® or external hard discs, for example.

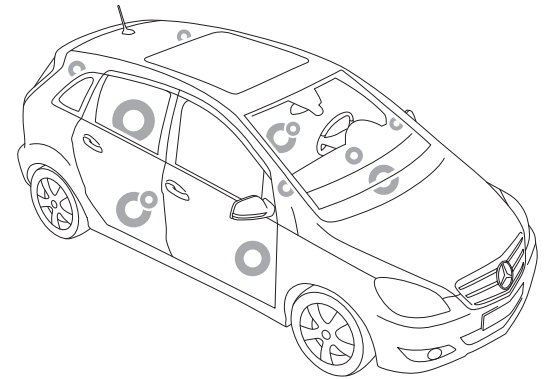

<sup>1</sup> For an optimal listening experience, the MP3 files should have a bit rate of at least 128 kbps



RADIO

DISC

NAVI

TEL



SYS



ON



12:29 FM 92.2 MHz TA  
• SWR2 BW • 90.8 MHz  
• ANTENNE 2 • SWR4 S  
SWR3  
Radio Speicher Klang

1

Q.D

2

ABC

3

DEF

4

GHI

5

JKL

6

MNO

7

PQRS

8

TUV

9

WXYZ

\*

+

0

↵

#

↕



C

OK

REAR

## And now, the sports highlights



The Sports package includes 10-spoke light-alloy wheels

The optional Sports package gives the B-Class an even more dynamic appearance. At the front, the distinctive chrome fins on the fog lamps set a more assertive tone, which is picked up by the 10-spoke light-alloy wheels whose powerful look advertises their sporting credentials. You will have plenty of opportunities to put them to the test as the perfectly tuned sports suspension encourages you to explore the potential of your vehicle. Those left behind can console themselves with the sight of the large exhaust pipe in polished stainless steel. The rear bumper with its high-shine decor stripes adds to the stylish ensemble. Incidentally, all the items in the Exterior Chrome package are included in the Sports package.







## Add a new dimension to every journey

An authentic sporty ambience is also very much in evidence inside the B-Class when the optional Sports package is ordered. The seats, which are upholstered in Bastogne fabric with ARTICO man-made leather side bolsters (the facing page shows the optional leather upholstery), are available in three colours. Particularly striking features include the

instrument cluster with white dial illumination and the leather shift lever with an aluminium cap. The aluminium highlights on the leather steering wheel add a further sporty touch while the stainless-steel pedals with rubber studs positively invite a dynamic driving style.





## Shine of the times: the Exterior Chrome package

The optional Exterior Chrome package (standard for the B 200 CDI) adds a special sparkle to the B-Class, even when it is stationary. The fog lamps with their stylish chrome surrounds, a tailpipe with a polished stainless-steel embel-

lisher and an exterior stainless-steel load sill guard are the most conspicuous elements. Elegance and sportiness are also the keynotes of the chrome trim on the bumpers, beltlines and rub strips.



Shining example: the Exterior Chrome package



The fine trim on the rear bumper

### STANDARD EQUIPMENT (selection)

3-point seat belts (5), front belts height-adjustable with belt tensioners and belt force limiters, outer rear belts with belt tensioners and automatic belt height adjustment

5-speed manual transmission<sup>1</sup> or 6-speed manual transmission<sup>2</sup>

ABS, BAS, ESP® and Hill-Start Assist

Active head restraints for driver and front passenger, adjustable for height and angle

Adaptive brake lights

Adaptive front airbags and head/thorax sidebags (backrest-mounted sidebags for additional head protection) for driver and front passenger

Aluminium trim strips on door panels, centre console and tunnel

ASSYST service interval indicator

Boot lighting and tailgate with integral ambient and signal light

Bulb failure indicator

Central locking with interior switch, automatic locking and crash sensor

Crash-responsive emergency lighting

Diesel particulate filter (for diesel models only)

Door sills with aluminium insert (front sills additionally with “Mercedes-Benz” lettering)

Driver’s seat with manual height adjustment

Electronic immobiliser, incl. locking system with remote control and visual lock confirmation (recognised by the Allianz Technology Centre and the German Technical Inspection Authority)

Front armrest and net in front passenger footwell

Headlamp Assist (automatic headlamp activation)

Heated exterior mirrors left and right painted in vehicle colour, electrically adjustable from inside the vehicle, with aspherically curved mirror glass

Height-adjustable load compartment floor (2 levels)

<sup>1</sup> Standard for B 160 BlueEFFICIENCY, B 180 BlueEFFICIENCY, B 180 NGT BlueEFFICIENCY and B 200

<sup>2</sup> Standard for B 180 CDI and B 200 CDI



The rear head restraints



The belt status display for the rear seats



**STANDARD EQUIPMENT (selection)**

ISOFIX child seat attachment points with TopTether in rear
Manual childproof locks on rear doors
Multifunction steering wheel and on-board computer with current fuel-consumption display
Outside temperature display
Overhead control panel with front passenger reading light, separately switched rear area light
Power windows at the front (2) with one-touch up and down control
Projection-beam headlamps
Rear head restraints (3), retractable and adjustable for height and angle
Rear windscreen wiper with intermittent wipe setting and one-touch control
Retractable luggage compartment cover
Rub strips front and rear, painted in vehicle colour
Seat occupancy sensor in front passenger seat

Selective damping system
Side skirts and door handles in vehicle colour
Speed-sensitive steering with STEER CONTROL assistance system
Split-folding rear bench seat (1/3 :2/3), both rear seat cushions removable
Steering column manually adjustable for height and reach
THERMATIC automatic climate control with dust and pollen filter, air recirculation function and air-conditioned glove compartment
Tinted windows all round
TIREFIT tyre sealant with electric pump, first-aid kit
Tyre pressure loss warning system



THERMATIC automatic climate control



Power windows

**OPTIONAL EXTRAS (selection)**

---

Active Parking Assist, incl. PARKTRONIC

---

AMG 5-spoke light-alloy wheels

---

Anti-theft alarm system with tow-away protection and interior monitoring

---

Audio 50 APS with DVD navigation, Audio 20 CD, Audio 5 CD

---

Automatic child seat recognition in front-passenger seat, for Mercedes-Benz-approved child seats with transponder

---

Automatic package: continuously variable automatic transmission (AUTOTRONIC) and cruise control

---

Automatically dimming interior and exterior mirrors

---

Bi-xenon headlamps with active light function and cornering light function, incl. headlamp cleaning system

---



---

Child seat recognition (automatic) in front passenger seat, for Mercedes-Benz-approved child seats with a transponder

---

COMAND APS multimedia system with map-based hard-disc navigation, LINGUATRONIC, etc.

---

EASY-VARIO system, consisting of: removable rear seat backrests (1/3 and 2/3 sections) and removable front passenger seat with forward-folding backrest

---

Electric seat adjustment

---

Electrically folding exterior mirrors left and right

---

Exterior Chrome package

---

Folding and removable rear armrest incl. through-loading facility, with cup holder

---

Front fog lamps

---



THERMOTRONIC luxury automatic climate control



Active Parking Assist: instrument cluster display

**OPTIONAL EXTRAS (selection)**

---

 Front sports seats
 

---



---

 Harman Kardon® Logic 7® surround sound system
 

---



---

 Heated front seats
 

---



---

 Integral child seats
 

---



---

 Light and Sight package, consisting of: interior mirror with automatic dimming function, rain sensor, headlamp switch-off delay, locator lighting, reading light for driver, reading light in rear, illuminated vanity mirror, footwell lights
 

---



---

 Multicontour backrest for driver's seat
 

---



---

 Panoramic louvred sliding sunroof
 

---



---

 Panoramic sunroof
 

---



---

 Power windows at rear, with automatic one-touch up/down control, summer opening function and convenience closing
 

---



---

 Seat Comfort package, consisting of: height-adjustable front passenger seat, front seats with seat cushion angle adjustment and lumbar support
 

---



---

 Sidebags in rear
 

---



---

 Sports package
 

---



---

 THERMOTRONIC luxury automatic climate control
 

---



---

 Trailer coupling
 

---



---

 Windowbags
 

---

The equipment of the B-Class may vary slightly in different countries and regions. Please consult your Mercedes-Benz dealer for details



The Harman Kardon® Logic 7® surround sound system



Panoramic louvred sliding sunroof

## Wheels that suit your B-Class down to the ground



Steel wheels with wheel trim with 195/65 R 15 and 205/55 R 16 tyres (standard)



5-spoke light-alloy wheels with 205/55 R 16 tyres (optional extra)<sup>1</sup>



5-twin-spoke light-alloy wheels with 205/55 R 16 tyres (optional extra)



Sports package: 10-spoke light-alloy wheels with 215/45 R 17 tyres (optional extra)



5-twin-spoke light-alloy wheels, painted in titanium silver, with 215/45 R 17 tyres (optional extra)<sup>2</sup>



AMG 5-spoke light-alloy wheels, painted in titanium silver, with 215/40 R 18 tyres<sup>2</sup>



5-twin-spoke bichromatic light-alloy wheels with 215/45 R 17 tyres (optional extra)

Light-alloy wheels top the wish list of many B-Class drivers. The wide range comprises everything from 5-spoke to 10-spoke light-alloy wheels and from titanium silver paintwork to the new bichromatic colour scheme – to mention just a small selection.

<sup>1</sup> Standard for B 200 CDI

<sup>2</sup> Also available in conjunction with Sports package

## Only from Mercedes-Benz. And only the best

The designo equipment packages allow you to give the B-Class an interior which is as individual as you are. For example, you can choose your preferred upholstery from no less than four different designo leather/Alcantara® combinations. The trim is manufactured from high-quality woods, in designo anthracite poplar or designo brown poplar,

each combined with designo black piano lacquer. A combination of the wood of your choice and high-quality leather also embellishes the designo shift/selecter lever. And then there are the high-quality, attractive velour floor mats, edged in designo leather. Further designo appointments and information can be found at [www.mercedes-benz.com/designo](http://www.mercedes-benz.com/designo)



Trim in designo brown poplar



The exclusive look of designo black piano lacquer







## Made to fit your lifestyle and our vehicles

Mercedes-Benz genuine accessories open up even more possibilities for using your B-Class. Whatever you have in mind, the chances are that our accessories range has the ideal equipment. How about a weekend's cycling, for example? It's no problem with the interior cycle rack for up to two standard-size bicycles. Additional stowage space can be provided by the Mercedes-Benz roof boxes. The roof boxes, with a choice of three different sizes (capacity 330–450 litres), can be ordered in titanium

metallic or matt silver. The accessories range also makes it easy to enjoy your favourite music en route in your B-Class. If you have an iPod® or another MP3 player, the Mercedes-Benz Interface Kit simplifies the business of integrating your music tracks into the vehicle's audio system so that you can select them conveniently and safely by means of the buttons on the multifunction steering wheel and see the iPod® menu on the instrument cluster display. Sports-minded drivers who want to un-

derline the dynamic character of the B-Class will find the range includes a roof spoiler, high-gloss chromium-plated exterior mirror housings and door handle recesses with the same chrome finish. Further details of these and many other accessories can be found in our accessories brochures.

Please note: due to the wide variety of bicycles on the market, it may be necessary to adjust or remove certain attached parts such as handlebars, saddles or mudguards. We therefore recommend a trial installation





# Anyone opting for a Mercedes buys far more than just a car

**Mercedes-Benz Museum.** 125 years of automotive history in one place – this is what awaits you at the Mercedes-Benz Museum in Stuttgart. Experience the unique excitement, and embark upon a thrilling journey through time. Housed inside an architecturally impressive building, over 1500 exhibits on nine levels give you an insight into the unique tradition and powers of innovation of the Mercedes-Benz brand. See the world's first two automobiles in the shape of the Benz Patent-Motorwagen (motor car) and the Daimler motorised carriage – both from the year 1886. Two linked circuits take you from the beginnings of the automobile, past a series of unforgettable classics, through more than 100 years of motor racing history and, finally, on to a glimpse of what the future holds – in an area covering a total of 16,500 square metres. Enjoy the unique brand experience. We look forward to your visit. Further details can be found at [www.mercedes-benz-classic.com/museum](http://www.mercedes-benz-classic.com/museum)

**MercedesCard.** The card is your ticket to the Mercedes-Benz experience: four times a year, we will send you exciting details of a selected range of events and services, which we have put together exclusively for you. Then there is the Mercedes Magazine with its fascinating reports and articles. But the MercedesCard also has many other uses: as a VISA credit card, it is an internationally accepted means of payment. Plus it offers further benefits to provide you with peace of mind, such as insurance packages. You can also gain free entry to the Mercedes-Benz Museum simply by showing your VISA MercedesCard. Further details can be found at [www.mercedes-benz.de/mercedescard](http://www.mercedes-benz.de/mercedescard)<sup>1</sup>

**Mercedes-Benz Financial Services.** Mercedes-Benz stands for quality, innovation and safety – and the same applies to Mercedes-Benz Financial Services. Our innovative leasing and financing products are tailored to your financial needs and means, making it easy for you to secure the keys to your dream car. Once you are on the road, our insurance products offer you just the right level of protection on every trip. Finally, our service products ensure that your car is always in tip-top condition whilst keeping costs transparent and easily manageable. For a detailed quotation, please contact your Mercedes-Benz dealer, who will be glad to go through the latest financial offers and terms together with you.

<sup>1</sup> Information about the MercedesCard in Austria and Switzerland can be found on the Mercedes-Benz websites for these countries



**Mercedes-Benz mobility.** Your new car comes with the assurance of carefree driving, but if you should ever need help Mercedes-Benz Service24h is there for you. Just call the free-phone service hotline on 00800 1 777 7777<sup>2</sup>. The newly integrated telematics service Mercedes-Benz Contact<sup>3</sup> is even more customer-friendly: a touch of a button is all it takes to contact the Mercedes-Benz customer centre. If you wish, the relevant vehicle and position-related data can be transmitted at the same time, ensuring the shortest possible reaction time and rapid assistance. Also standard with your new car at no extra charge is the Mercedes-Benz Mobilo<sup>4</sup> mobility package. Whether you have lost your key, have had a breakdown which cannot be repaired immediately or if the vehicle is damaged due to an accident or vandalism, Mobilo ensures that you still reach your destination – anywhere in Europe. Whatever your problem, one thing is certain: you will soon be able to resume your journey.

**Service packages.** Vehicle-specific services allow you to put together an individual package for your Mercedes, including long-term protection against unforeseeable repair costs and high-quality servicing with genuine Mercedes-Benz parts. You can also count on the extensive network of Mercedes-Benz workshops, where you will receive the usual high standard of service for your Mercedes at a predictable, fixed price. Please ask your Mercedes-Benz dealer for further details.

**Test drive.** The unique feeling of driving a Mercedes cannot be put into words. Which is why we'd like to invite you to take a test drive. Simply visit [www.mercedes-benz.com](http://www.mercedes-benz.com) to locate the nearest Mercedes-Benz dealer in your country or region. We look forward to seeing you.

**Interactive Owner's Manual.** The website also offers an interactive tour, enabling you to take a closer look at your desired model. These informative clips are the ideal way to acquaint yourself with your dream car. You can view key functions in detail, gain an insight into the car's inner workings or look at the benefits of each model. For further details, go to:  
[www.mercedes-benz.de/owners\\_manual](http://www.mercedes-benz.de/owners_manual)

**Mobile internet.** Now you can access the entire world of Mercedes-Benz from your mobile phone. As well as an overview of all the passenger car models, there are insights into the entire brand world along with a wealth of entertainment offers and direct links to our range of services at [www.mercedes.mobi](http://www.mercedes.mobi)

<sup>2</sup> Mobile phone rates vary according to service provider

<sup>3</sup> Only in conjunction with a factory-fitted radio and switched-on mobile phone. For the cost of a call to the landline network

<sup>4</sup> When the warranty has expired Mobilo can be extended by another year for a maximum of 30 years, provided that regular maintenance is carried out by your Mercedes-Benz service partner

GRONINGEN FABRIC<sup>1</sup>

471 black



475 orient beige



478 alpaca grey

ARTICO MAN-MADE LEATHER/BASTOGNE FABRIC<sup>2</sup>

721 black



725 orient beige

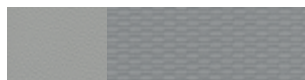

728 alpaca grey

LEATHER<sup>3</sup>

801 black

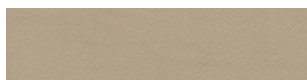

805 orient beige



808 alpaca grey

SPORTS SEATS IN ARTICO MAN-MADE LEATHER/ZANDVOORT FABRIC<sup>3</sup>

751 black

designo LEATHER/ALCANTARA<sup>®</sup> APPOINTMENTS<sup>3</sup>

X20 designo black



X90 designo alpaca grey



X91 designo java



X93 designo imperial red

## TRIM

Diagonally polished light aluminium<sup>1</sup>727 High-gloss brown myrtle wood<sup>3</sup>designo TRIM<sup>3,4</sup>W62 designo anthracite poplar wood,  
high-glossW68 designo brown poplar wood,  
high-gloss<sup>1</sup> Standard equipment<sup>2</sup> Optional extra and included in Sports package<sup>3</sup> Optional extra<sup>4</sup> Preferred trim included with designo leather/Alcantara<sup>®</sup> appointments

	B 180 CDI	B 200 CDI	B 160 BlueEFFICIENCY <sup>4</sup>	B 180 BlueEFFICIENCY <sup>5</sup>
No. of cylinders/arrangement	4/in-line	4/in-line	4/in-line	4/in-line
Total displacement (cc)	1991	1991	1498	1699
Rated output <sup>1</sup> (kW at rpm)	80/4200	103/4200	70/5200	85/5500
Rated torque <sup>1</sup> (Nm at rpm)	250/1600–2600	300 (280)/1600–3000	140/3500–4000	155/3500–4000
Compression	18	18	11	11
Acceleration 0–100 km/h (s)	11.3 (11.8)	9.6 (9.7)	13.2 (14.2) <sup>6</sup>	11.3 (12.0) <sup>6</sup>
Top speed, approx. (km/h)	183 (178)	200 (195)	174 (168) <sup>6</sup>	184 (180) <sup>6</sup>
Tyre size	205/55 R 16	205/55 R 16	195/65 R 15	195/65 R 15
Fuel	Diesel	Diesel	Premium petrol	Premium petrol
Fuel consumption <sup>2</sup> (l/100 km)				
urban	6.7–6.7 (6.7–7.3)	6.6–6.6 (6.7–8.0)	8.1–8.2 (8.7–8.9) <sup>6</sup>	8.0–8.2 (9.2–9.4) <sup>6</sup>
extra-urban	4.4–4.5 (4.9–5.3)	4.5–4.6 (4.9–5.3)	5.4–5.6 (6.2–6.4) <sup>6</sup>	5.3–5.7 (6.2–6.4) <sup>6</sup>
combined	5.2–5.3 (5.6–6.0)	5.2–5.3 (5.6–6.3)	6.4–6.6 (7.1–7.3) <sup>6</sup>	6.3–6.6 (7.3–7.5) <sup>6</sup>
CO <sub>2</sub> emissions <sup>2</sup> (g/km), combined	136–139 (146–158)	136–139 (146–165)	149–152 (168–173) <sup>6</sup>	146–153 (173–177) <sup>6</sup>
Emission class	Euro 5 (Euro 5)	Euro 5 (Euro 5)	Euro 5 (Euro 5) <sup>6</sup>	Euro 5 (Euro 5) <sup>6</sup>
Tank capacity (l/of which reserve approx.)	54/6	54/6	54/6	54/6
Natural gas tank capacity (kg/of which reserve approx.)	–	–	–	–
Kerb weight <sup>3</sup> (kg)	1435 (1470)	1435 (1470)	1320 (1350) <sup>6</sup>	1330 (1360) <sup>6</sup>
Perm. GWV (kg)	1880	1880	1835	1830

Figures in brackets apply to vehicles with automatic transmission

<sup>1</sup> Figures according to Directive 80/1269/EEC in the currently applicable version

<sup>2</sup> The figures shown were obtained in accordance with the prescribed measuring process (Directive 80/1268/EEC in the currently applicable version). The figures are not based on an individual vehicle and do not constitute part of the product offer; they are provided solely for the purposes of comparison between different vehicle models

<sup>3</sup> Figures according to Directive 92/21/EC, version 95/48/EC (kerb weight with fuel tank 90% full, driver, 68 kg, and luggage, 7 kg) for standard-specification vehicles. Optional extras and accessories will generally increase this figure and reduce the payload capacity accordingly

<sup>4</sup> With manual transmission and ECO start/stop function as standard. Optionally available as B 160 with automatic transmission

<sup>5</sup> With manual transmission and ECO start/stop function as standard. Optionally available as B 180 with automatic transmission

B 180 NGT BlueEFFICIENCY		B 200
4/in-line		4/in-line
2034		2034
85/5750		100/5500
165/3500-4000		185/3500-4000
11		11
12.4 (13.2)		10.1 (10.2)
184 (180)		196 (190)
205/55 R 16		205/55 R 16
Natural gas	Premium petrol	Premium petrol
6.4 (6.5) <sup>7</sup>	9.7 (9.9)	8.8-9.1 (9.7-9.9)
4.1 (4.3) <sup>7</sup>	5.9 (6.2)	5.5-5.7 (6.2-6.4)
4.9 (5.1) <sup>7</sup>	7.3 (7.6)	6.7-7.0 (7.5-7.7)
135 (139)	170 (177)	158-164 (177-182)
Euro 5 (Euro 5)	Euro 5 (Euro 5)	Euro 5 (Euro 5)
54/6		54/6
16/1.5		-
1470 (1515)		1345 (1390)
1950		1880

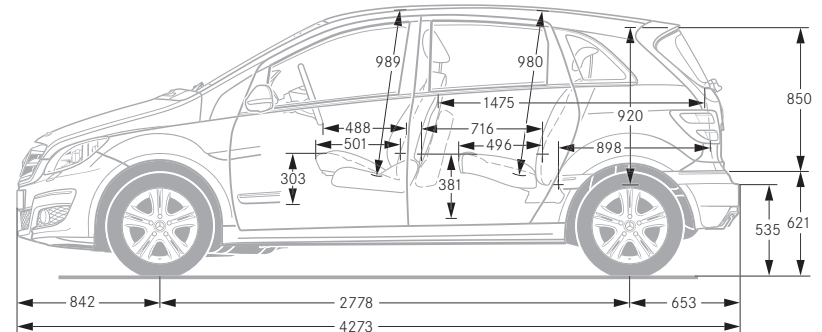
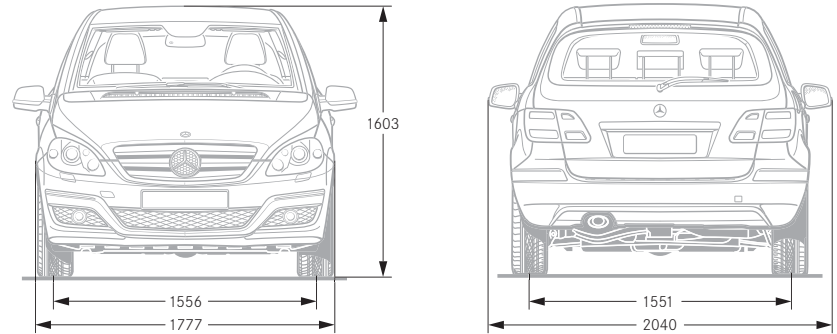

<sup>6</sup> Figures apply to petrol versions of B 160 and B 180

<sup>7</sup> These figures, in kilograms per 100 km, apply exclusively to natural-gas operation

All measurements in millimetres. The dimensions shown are mean values and apply to standard-specification, unladen vehicles



NON-METALLIC PAINTS<sup>1</sup>

589 jupiter red



650 cirrus white



696 night black

METALLIC PAINTS<sup>2</sup>

191 cosmos black



240 lotus blue



391 horizon blue



478 delta green



490 steppe brown



597 saturn red



761 polar silver



787 mountain grey

<sup>1</sup> Standard equipment<sup>2</sup> Optional extra

**Take-back of end-of-life vehicles.** Coming full circle. At the end of its long life, you can return your B-Class to us for environment-friendly disposal in accordance with the EU End-Of-Life Vehicle Directive<sup>1</sup>. But that day lies a long way off.

<sup>1</sup> Applies in accordance with national regulations to vehicles up to 3.5 tonnes gross weight. Mercedes-Benz passenger cars have met the statutory regulations governing the suitability of their design for reuse and recycling for a number of years now. A network of vehicle take-back depots and dismantlers has been established which will process your vehicle in an environment-friendly manner. The ways in which both vehicles and parts can be recovered are subject to ongoing development and improvement. Consequently, the B-Class will be able to comply with any future increases in the recycling quota within the stipulated time limits. For further information please call 00800 1 777 7777.

**Please note:** Changes may have been made to the product since this brochure went to press (29.07.2010). The manufacturer reserves the right to make changes to the design, form, colour and specification during the delivery period, provided these changes, while taking into account the interests of the vendor, can be deemed reasonable with respect to the purchaser. Where the vendor or the manufacturer uses symbols or numbers to describe an order or the subject of an order, no rights may be derived solely from these. The illustrations may show accessories and items of optional equipment which are not part of standard specification. Colours may differ slightly from those shown in the brochure, owing to the limitations of the printing process. This brochure has been compiled by Daimler AG of Germany and is distributed internationally. It provides a general indication of the range of models, features, optional extras and/or colours available in various countries. Some of the models, features, optional extras and/or colours may not be available in your country, or may only be available in a different specification. Additionally some models, features, optional extras and/or colours may only be available in combination with others. For current and more specific information in relation to the range of models, features, optional extras and/or colours available in your country, and their pricing, you should contact your nearest authorised Mercedes-Benz Passenger Car Dealer.

[www.mercedes-benz.com](http://www.mercedes-benz.com)