

This Brochure is prepared by Daimler AG and it predominantly reflects the capabilities and performance of vehicles sold in Europe. Some characteristics, capabilities, performance features and optional extras (e.g. towing systems) may not be available or may not apply in Australia or under Australian conditions. The information in this Brochure is therefore indicative, illustrative and provided only for guidance and should not be relied on. To obtain current and accurate information on a vehicle and any options applicable to Australia, contact your local authorised Mercedes-Benz dealer.



Mercedes-Benz

# E-Class Coupé and Cabriolet



Mercedes-Benz



Machine has stirred. The E-Class Coupé shows its face. It displays its good looks  
tion of power. **E-Class Coupé. Pure Attraction.** A suspension which smooths out  
it all. The only thing that's missing is a driver. Way to go: the multifunction s  
ur fingertips: your personal command centre. Sport is the muscular design. T  
sions of the light-alloy wheels. Sport is your pulse rate. And the AMG Sports  
Only one thing matters here: the time you spend in the E-Class Coupé. Toget  
characteristic in sports mode at the touch of a button, there's nothing standing betw  
andstill: the sporty arrow-shape of the front end extends from the radiator rig  
-Class Cabriolet elegantly leaves the slipstream behind and always leads the f  
e design. The open interior is a calmer & quieter place to be - with noticeably  
e in the E-Class Cabriolet never ends: the carefree feeling stays with you, as c

s. It flexes its muscles. And it demonstrates style. All to get your undivided a  
ut the road. A transmission which skips gears. A brake which can think for it  
teering wheel. Talk of the town: the multimedia system with a telephone func  
The directness of the steering. Sport is the tuning of the sports suspension. Th  
package will set it racing. Forget distances. Seconds, minutes and hours are v  
her with the optional Dynamic Handling package which tightens the shock a  
ween you and the pleasure of an outing in the E-Class Coupé. Dynamic even v  
ght across the entire bonnet. The prominent, rising side line blends into a dist  
field - with agility, outstanding technology and numerous assistance systems  
y more space. **E-Class Cabriolet. It's about airstream. Not mainstream.** You've  
does the knowledge that lots of assistance and safety systems remain vigilant



**Coupé.** It exerts a magical allure. The E-Class Coupé turns heads. It makes you want to get in. With its extroverted design and timeless good looks. With its sheer power delivery and refined handling. With its integral safety and highest-possible levels of comfort. With everything that distinguishes a Mercedes-Benz coupé: with the kind of passion that just won't loosen its grip.

At a glance | from page 4    Insight | from page 16

**Cabriolet.** The mere sight of it is captivating. The pioneering forms, the innovative technology plus superb driving dynamics and aerodynamic characteristics leave their mark on the vehicle's segment as well as on the drivers themselves. Take AIRSCARF and the innovative AIRCAP, for instance – they turn virtually every kind of weather into cabriolet weather: for up to four occupants who soon realise that anyone enjoying a ride in this particular vehicle literally won't be left cold by the airstream – and they will certainly never be left cold by the E-Class Cabriolet in a figurative sense, either.

At a glance | from page 20    Insight | from page 30

## E-Class Coupé and Cabriolet

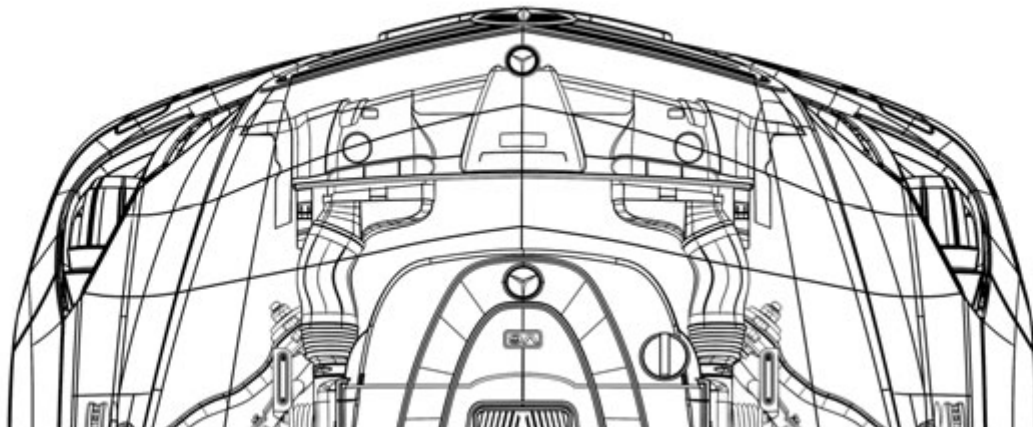

**Dynamism in top form:** engines, exhaust systems, transmissions, AGILITY CONTROL package and Dynamic Handling package.

Drive system & chassis | from page 36

**Multifaceted safety:** innovations and tried-and-trusted technologies that help prevent accidents, or reduce the severity of any accidents and their consequences.

Safety | from page 46

**Relax on the journey:** all you need to know about the multimedia and assistance systems, air conditioning, seats and comfortable cabriolet driving.

Comfort | from page 52

**Vehicles with character:** interior concepts, AMG Sports package, designo, standard and optional equipment, wheels and genuine accessories.

Equipment | from page 62

**Star service:** Mercedes-Benz Museum, MercedesCard, Mercedes-Benz Financial Services, Mercedes-Benz mobility, service packages, test drive, Interactive Owner's Manual, mobile internet.

Services | from page 80

**Go into detail:** technical data, dimensions and paintwork.

Facts & colours | from page 82



# Magnet!

Resistance useless

The machine has stirred. The E-Class Coupé shows its face. It displays its good looks. It flexes its muscles. And it demonstrates style. All to get your undivided attention.







In focus: the E 350 CGI BlueEFFICIENCY with direct injection | AGILITY CONTROL package | ADAPTIVE BRAKE with HOLD function

# Arrow!

## Hooked on torque

It has an engine which is the definition of power.  
A suspension which smooths out the road. A transmission  
which skips gears. A brake which can think for itself.  
It has it all. The only thing that's missing is a driver.  
→ Page 38-45







Way to go: the multifunction steering wheel. Talk of the town: the multimedia system with a telephone function. At your fingertips: your personal command centre. → Page 52

Your option: COMAND APS multimedia system with the voice-operated control system LINGUATRONIC

# Muscles!

Tangibly alluring



Your option: AMG Sports package



Sport is the muscular design. The directness of the steering. Sport is the tuning of the sports suspension. The dimensions of the light-alloy wheels. Sport is your pulse rate. And the AMG Sports package will set it racing, guaranteed!

→ Page 68-71







# Non-stop!

Pleasure all the way





Forget distances. Seconds, minutes and hours are what count.  
Only one thing matters here: the time you spend in the E-Class Coupé.





## Even bumps in the road can be smoothed out

Roads have their highs and lows, just like the swell of the ocean. Jetties are built for ships, so that they can move in shallow waters when in harbour. Where roads are concerned it's a little trickier: new uneven sections and holes are constantly appearing, caused by rain, frost and construction work.

If a car is to drive as comfortably and quietly as a ship sails on a calm sea, its suspension has to adapt to the roads; it has to smooth them out. Mercedes-Benz has come up with the solution: the AGILITY CONTROL package. It lessens the impact of uneven sections of road by constantly setting its dampers in accordance with the surface being driven over. And at the same time it enhances the road roar and tyre vibration characteristics. This, along with the optional Dynamic Handling package, which tightens the shock absorber characteristic at the touch of a button in sports mode, sees to it that there are no obstacles to enjoying a trip in the E-Class Coupé.

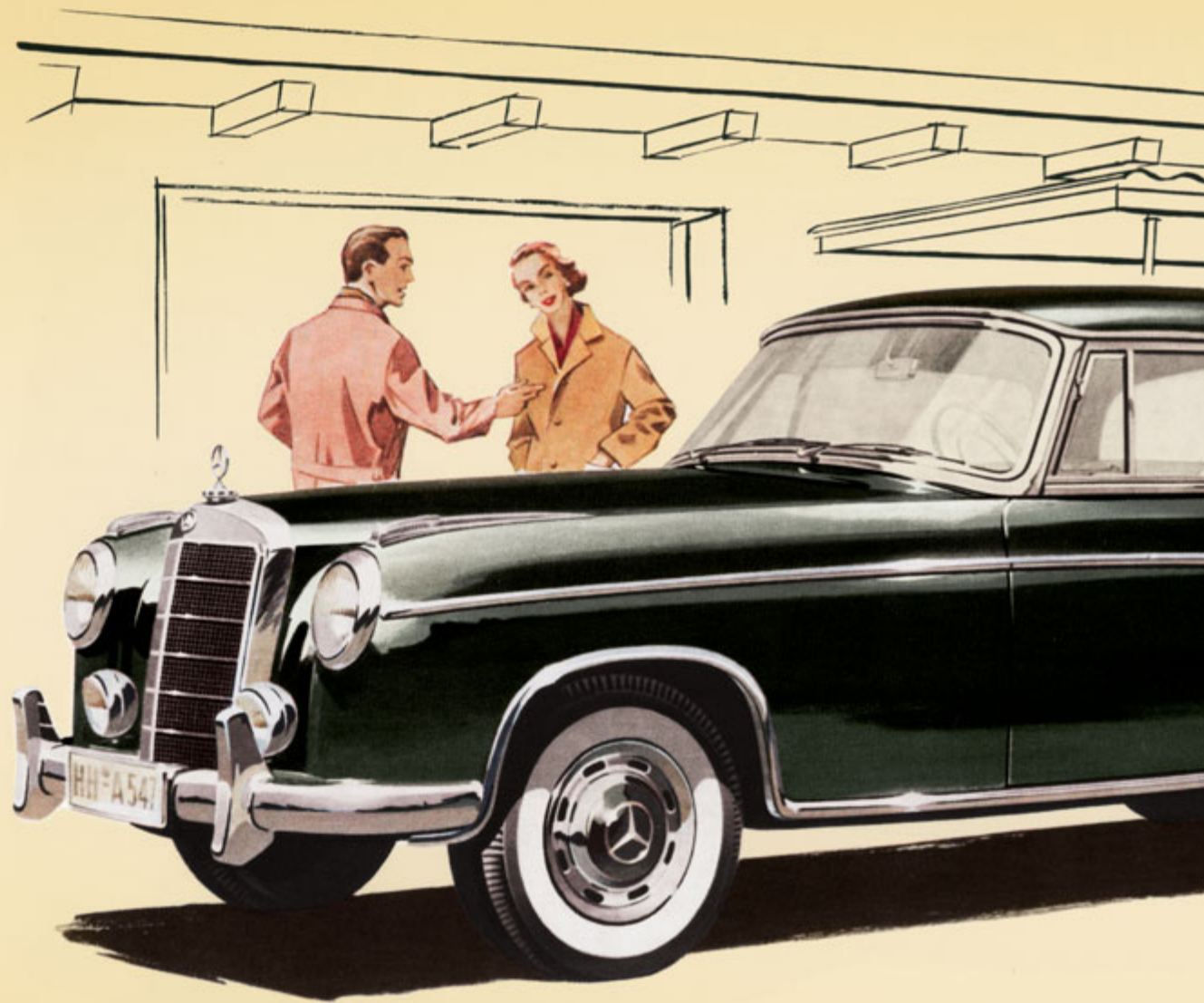

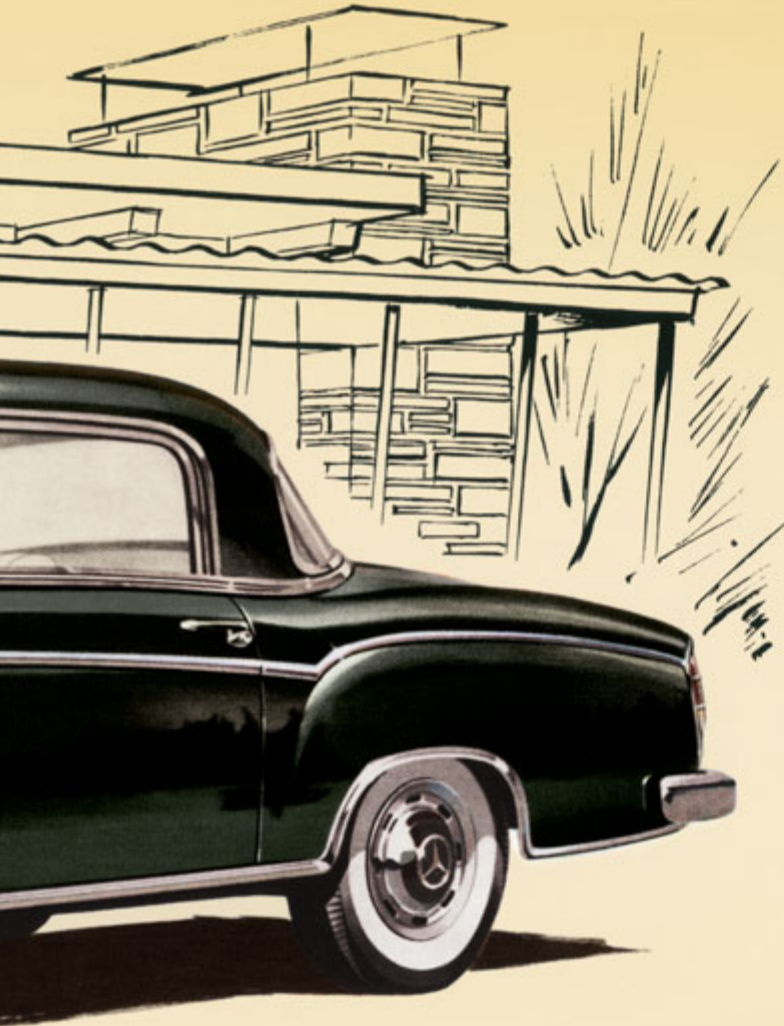

## Beauty is in the genes

Good looks are in the blood – the E-Class Coupé and the E-Class Cabriolet are living proof of this widely held belief. With its progressive technology and comfortable self-supporting chassis-body structure – not to mention its sheer elegance – the 220 S Coupé set a significant milestone in automotive history as early as 1956. These same qualities are still very much in evidence to this day: elegance and comfort are the distinguishing character traits of today’s Mercedes-Benz coupés.

The 220 S Coupé is one of the forebears of the Gran Turismo, epitomising the culture of “splendid travel”. In 1958 journalists at MOTOR REVUE rejoiced: “The 220 S offers so much in terms of comfort and performance. The interior equipment is absolutely outstanding.”

The E-Class Coupé and the E-Class Cabriolet certainly live up to this claim. They have everything it takes to be a classic right from the word go: the genes of the Mercedes-Benz coupé and cabriolet family.

Feel the warmth of the sun.

Dynamic even while at a standstill: the sporty arrow-shape of the front end extends from the radiator right across the entire bonnet.





# You'll still get goose bumps

The prominent, rising side line blends into a distinctive, muscular tail end.



In focus: the E 350 CGI BlueEFFICIENCY with direct injection

Journeys will seem shorter.

The E-Class Cabriolet elegantly leaves the slipstream behind and always leads the field –



# And the summer much longer

with agility, outstanding technology and numerous assistance systems for safety and comfort.







The wind knows no limits.

The airflow is directed over the vehicle by an innovative draught-stop system of unique design.



# So we showed it one

The open interior is therefore a calmer and quieter place to be – with noticeably more space even for four occupants. → [Page 54](#)



You've long since reached your destination.

A drive in the E-Class Cabriolet never ends, because that carefree feeling stays with you.





# Your thoughts are still on the move

As does the knowledge that numerous assistance and safety systems are always vigilant – every kilometre of the way.



## The art of taming the air

Anyone looking at a soap bubble rarely thinks of surface tension or the interference of light waves. It's much more likely that we will be amazed by the bright colours and the ease with which the bubble dances through the air. It's a bit like a drive in the cabriolet; we enjoy the freedom and the fresh air, but hardly anyone is interested in flow velocity, base pressure or secondary vortex. Unless they're an engineer at Mercedes-Benz.

Because it's precisely these complex processes that occur in the innovative AIRCAP technology: an ingenious system consisting of a wind deflector on the roof frame and a special draught-stop extends the flow curve over the passenger compartment. This makes for a quieter, more comfortable experience in the interior – for the rear passengers too. And they place particular importance on the ease with which the E-Class Cabriolet tames the air – whether they're experts in physics or not.





(kg) 2255 (2265) Rated torque (Nm at rpm) 400/1400-2800 (400/1400-2800)  
EFFICIENCY Rated output 215/6400 kW at rpm Intelligent Light System (ILS)  
Acceleration from 0-100 km/h (s) 6.5 EASY-ENTRY system Fuel premium  
6.3-6.6) ATTENTION ASSIST 7G-TRONIC AIRSCARF Kerb weight (kg) 1690  
Rated torque (Nm at rpm) 500/1600-1800 AIRCAP Tank capacity (l)/incl. reserve  
(kg) 1690 (1695) 7G-TRONIC Memory package Perm. GVW (kg) 2255 (2265) Displacement  
1796 cc Rated torque (kW at rpm) 150/5500 7G-TRONIC Compression ratio  
Top speed approx. 247 km/h DISTRONIC PLUS PRE-SAFE® Brake AGILITY CONTROL  
Y system Tyre size Front axle 235/45 R 17 7G-TRONIC EASY-ENTRY system  
capacity (l) 66 **The facts.** Kerb weight (kg) 1845 CO<sub>2</sub> emissions (g/km) combined  
R 17 Rated output (kW at rpm) 170/3800 Acceleration from 0-100 km/h (s)

36 **BlueEFFICIENCY**38 **Diesel engines**

4-cylinder

6-cylinder

40 **Petrol engines**

4-cylinder

6-cylinder

8-cylinder

42 **Exhaust systems**43 **Transmissions**

6-speed manual transmission

5-speed automatic transmission

7G-TRONIC

44 **Suspension**

AGILITY CONTROL package

AGILITY CONTROL sports suspension

Dynamic Handling package

ADAPTIVE BRAKE

46 **Safe driving**

ATTENTION ASSIST

Intelligent Light System

DISTRONIC PLUS

Blind Spot Assist

LED tail lights

Adaptive brake lights

48 **In the event of danger or an accident**

PRE-SAFE® system

PRE-SAFE® Brake

NECK-PRO head restraints

Active bonnet

Airbags

50 **Cabriolet safety**

Safety body

Roll-over protection

52 **Multimedia systems**

Central colour display and Controller

COMAND APS

Surround sound system

53 **Assistance systems**

PARKTRONIC inkl. Parking Guidance

Reversing camera

Speed Limit Assist

54 **Open-air comfort**

AIRCAP

AIRSCARF

Aerodynamics

56 **Soft top and space**

Automatic fabric soft top

58 **Climate control**

THERMATIC

THERMOTRONIC

60 **Seats**

Automatic belt feeders

EASY-ENTRY system

Rear seats

# E-Class Coupé and Cabriolet in detail

**62 Equipment**

Standard

ELEGANCE interior concept,  
including upholstery and trim  
AVANTGARDE interior concept,  
including upholstery and trim

**68 Equipment packages**

AMG Sports package

**72 designo****74 Standard****75 Optional extras****76 Wheels**

Standard wheels

Optional wheels

AMG light-alloy wheels

Accessory wheels

**78 Genuine accessories****80 Services**

Mercedes-Benz Museum

MercedesCard

Mercedes-Benz Financial Services

Mercedes-Benz mobility

Service packages

Test drive

Interactive Owner's Manual

Mobile internet

**82 Dimensions**

Coupé dimensions

Cabriolet dimensions

**83 Technical data**

Coupé technical data

Cabriolet technical data

**85 Paintwork**

## BlueEFFICIENCY – fast forward to tomorrow

We are quicker at getting environmentally friendly future technologies to where it matters most: on the road. As the inventor of the motor car, Mercedes-Benz has a special responsibility – one we have undertaken with all our might for many years. By the end of 2010, we will be able to offer you over 85 models with BlueEFFICIENCY technologies, all of which place far less of a burden on the environment – without compromising on safety, comfort and driving enjoyment.

Our BlueEFFICIENCY concept comprises innovations for efficient mobility as well as optimised processes all the way along the value chain. They involve different approaches, but they all have a common goal: to make your individual mobility as sustainable as possible.

**The BlueEFFICIENCY measures – the Mercedes-Benz efficiency package.** This package consists of comprehensive vehicle optimisations designed to save fuel and ease the burden on the environment. Each model combines the most

efficient engine with latest-generation aerodynamic and energy-management measures to minimise fuel consumption. Such measures include intelligently controlled ancillaries, tyres with optimised rolling resistance, lightweight components and the ECO start/stop function, which is being made available for an increasing number of models. The new BlueDIRECT V6 and V8 petrol engines in the S-Class, CL-Class and CLS-Class, for example, reduce fuel consumption by up to 24% yet have a much higher power output.

**BlueTEC – the clean diesel.** Mercedes-Benz has brought to market BlueTEC technology for diesel engines based on common-rail direct injection (CDI). A modular emission-control system makes BlueTEC an exceptionally clean diesel technology, as not only does it remove up to 95% of the particulate from the exhaust gases, it also reduces nitrogen oxides by up to 90%. All that remains is essentially water, harmless nitrogen and the satisfying feeling of having helped to ease the burden on the environment.

**HYBRID – the intelligent combination of petrol and electric drive.** A well-established team makes a lot of things easier. And this is certainly true in the case of HYBRID technology. Here the electric motor is used for the recuperation of braking energy, which is stored in the battery. When needed, this energy is returned to the electric drive, which assists the petrol engine when the car is accelerating. What's more, the ECU shuts off the petrol engine when the speed falls below 15 km/h. In this way, a HYBRID can reduce fuel consumption by up to 20%. So it looks



The BlueEFFICIENCY measures bring about a substantial reduction in fuel consumption and CO<sub>2</sub> emissions



after the environment as well as your bank balance. Perfect teamwork, you might say.

**BlueTEC HYBRID – clean diesel combined with electric drive.** It marries the benefits of the HYBRID with those of BlueTEC: during braking, the kinetic energy is converted into electrical energy, which can be re-used when required. At the same time, the BlueTEC technology cleans the exhaust gases and removes many of the pollutants. All of which makes the economical diesel powerplant even more efficient, agile and clean.



Taking the E-Class as a basis, we are using **BlueTEC HYBRID technology** to develop the first diesel hybrid in this class

**Innovative drive systems that break new ground: E-CELL and F-CELL.** Mercedes-Benz has developed these two locally emission-free drive systems. The B-Class F-CELL is already being produced on a small scale and has been displaying its everyday practicality on Germany's roads since mid-2010. It uses hydrogen to produce power for the electric motor in a fuel cell. The first models from a small series of the A-Class E-CELL – featuring an electric motor which draws its energy from two lithium-ion batteries, giving it an average range of more than 200 km –



The A-Class **E-CELL** allows locally emission-free driving with a battery-powered electric motor



will start to roll off the production line at the end of 2010. There will also be an E-CELL PLUS, which will include a small internal combustion engine (Range Extender) to increase the range of the electric vehicle.

But that is not all: under the banner “Design for Environment”, we also look at a vehicle's entire lifecycle and work hard to preserve the environment from the planning stage right through to recycling. The same applies to the building and running of new plants. In addition, we are heavily involved in the development of alternative fuels and carry out research in the field of bionics. In short, BlueEFFICIENCY is good news for both you and the environment.

Further information about our comprehensive measures can be found at:  
[www.mercedes-benz.com/blueefficiency](http://www.mercedes-benz.com/blueefficiency)

## Diesel engines

The latest generation of diesel engines is available for the E-Class Coupé and Cabriolet. All the equipment involved is fitted with particulate filters and meets the stringent Euro 5 emission class. The engines are particularly economical, powerful, clean and quiet.



The 4-cylinder diesel engine in the E 220 CDI BlueEFFICIENCY combines pulling power with low consumption

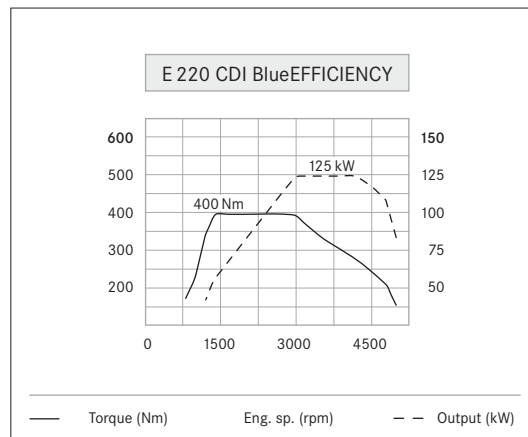

The E 220 CDI BlueEFFICIENCY combines economy and performance

**4-cylinder diesel engine.** Beavering away in the E 220 CDI BlueEFFICIENCY and in the E 250 CDI BlueEFFICIENCY is an efficient 4-cylinder diesel engine. Especially impressive are its economy, pulling power and refinement. The E 220 CDI BlueEFFICIENCY has a maximum torque of 400 Nm and a rated output of 125 kW. In the E 250 CDI BlueEFFICIENCY the maximum torque of 500 Nm is already available in the lower engine speed range between 1600 and 1800 rpm – and an output of 150 kW is on tap if required.

The engine is now up to 15% more powerful than previous comparable coupé models, for example, whilst torque has increased by up to 20%. At the same time fuel consumption and CO<sub>2</sub> emissions have dropped by up to 20%. Co-responsible for these impressive achievements are fourth-generation common-rail technology, whose injection pressure has been increased to 2000 bar, optimised combustion chambers and extremely precise piezo injectors. Two-stage charging ensures high torque in every engine speed range, whilst the requisite refinement comes courtesy of two Lanchester balancer shafts.

**The 6-cylinder diesel engine.** Impressive figures characterise the E 350 CDI BlueEFFICIENCY. With its six cylinders the engine produces an output of 170 kW and a maximum torque of 540 Nm at 1600 to 2400 rpm: a healthy reserve for spontaneous sprints. At the same time the engine works cleanly and economically, with help from the fast, precise piezo injectors, the injection pressure of up to 1600 bar and the lightweight design throughout.

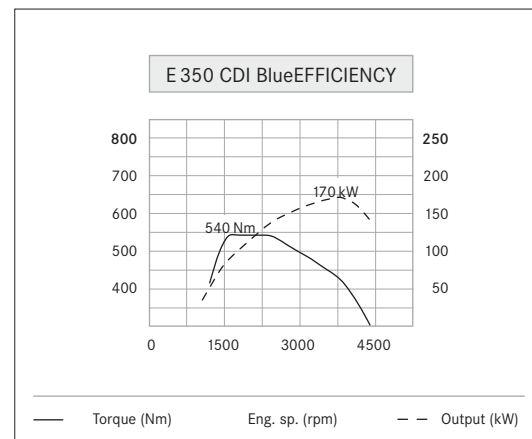

The E 350 CDI BlueEFFICIENCY posts an excellent set of output and torque figures

## Petrol engines

Fun at the wheel and environmental compatibility can go hand in hand, thanks to engine technologies that are impressively powerful but at the same time reduce CO<sub>2</sub> and fuel consumption. You need look no further than the petrol models for proof – they comply with the stringent Euro 5 emission class.

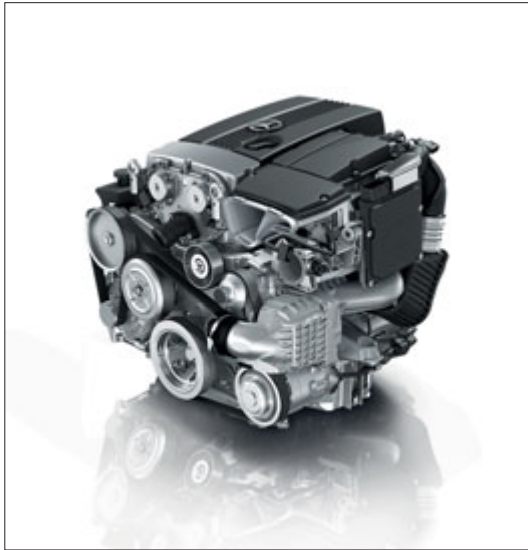

The latest engine technology featuring high-pressure direct injection with piezo injectors in the E 250 CGI BlueEFFICIENCY

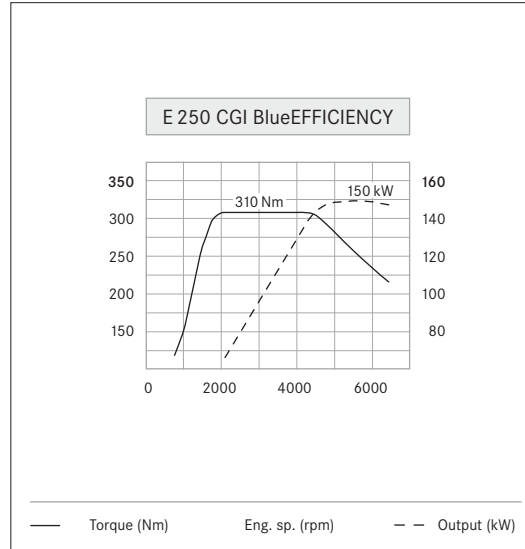

Highly efficient and conserves resources: the E 250 4-cylinder petrol engine

### 4-cylinder petrol engine with direct injection.

There is a particularly efficient unit at work in the E 200 CGI BlueEFFICIENCY<sup>1</sup> and in the E 250 CGI BlueEFFICIENCY: the 4-cylinder in-line engine with turbocharging and direct injection. Not only does its design ensure refinement in all engine speed ranges; it also facilitates a high output and an impressive torque without much displacement – just 1.8 l to be precise. The resultant reduced weight and the lower internal friction keep consumption well and truly down. What's more, the CGI direct injection makes a worthy contribution to the engine's efficiency. The two 4-cylinder petrol engines are available in the following power bands:

<sup>1</sup> In conjunction with 6-speed manual transmission including ECO start/stop function

- In the E 200 CGI BlueEFFICIENCY 135 kW and maximum torque of 270 Nm
- In the E 250 CGI BlueEFFICIENCY 150 kW and maximum torque of 310 Nm

#### 6-cylinder petrol engine with direct injection.

State-of-the-art technology forms the basis for the drive system in the E 350 CGI BlueEFFICIENCY: 4 valves per cylinder, variable intake and exhaust camshaft adjustment, a two-stage intake manifold and a balancer shaft. The E 350 CGI BlueEFFICIENCY saves fuel, reduces CO<sub>2</sub> emissions and impresses with enhanced refinement. These advantages are down to the second-generation direct petrol injection system from Mercedes-Benz, which operates using spray-guided combustion and high-pressure injection.

Maximum power and peak torque – 215 kW and 365 Nm respectively – are available in a wide range from 3000 to 5100 rpm.

**8-cylinder petrol engine.** The crowning glory of the range of engines for the E-Class Coupé and Cabriolet is a superb specimen: the E 500. This 8-cylinder unit boasting 285 kW develops a maximum torque of 530 Nm at 2800 to 4800 rpm. Accelerating from 0 to 100 km/h in 5.2 seconds in the coupé and 5.3 seconds in the cabriolet and with a governed top speed of 250 km/h, the E 500 is a sports car through and through.

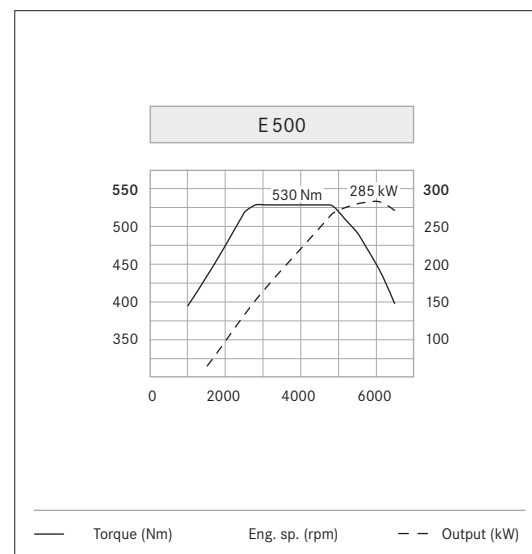

The E 500 places its impressive torque of 530 Nm at your disposal from 2800 rpm

## Exhaust systems

With their chic chrome look the exhaust systems emphasise the sporty ambitions of the E-Class Coupé and Cabriolet. They are precisely tailored to each engine to ensure optimum performance figures.

There are three different exhaust systems available – both for the E-Class Coupé and Cabriolet: the 4-cylinder models are fitted with an oval tailpipe, the 6-cylinder models with

two oval tailpipes. The 8-cylinder engine in the E 500 also has a two-pipe exhaust system; as a differentiating feature the trapezoidal pipes are integrated into the bumper covering. A catalytic

converter for the petrol models and a particulate filter for the diesel models are obligatory.



The 4-cylinder models have an oval tailpipe



The 6-cylinder models are fitted with two oval tailpipes



The two-pipe exhaust system with its trapezoidal tailpipes distinguishes the 8-cylinder model

# Transmissions

Whether you prefer a dynamic or a more relaxed driving style, the manual and automatic transmissions ensure optimum engine power transmission in each and every traffic situation.

**Transmissions for 4-cylinder models:** the 6-gear manual transmission in the E 220 CDI, E 250 CDI and E 200 CGI BlueEFFICIENCY facilitates particularly fast gear changes with very short



Individual gears can be skipped when changing down with the 7G-TRONIC if spontaneous acceleration is called for

and precise shift travel. At the same time ride comfort is increased through precise tuning of the engine output, gear spacing and rear axle ratio. The 5-speed automatic transmission in the E 250 CGI BlueEFFICIENCY (optional for the E 220 CDI, E 250 CDI and E 200 CGI BlueEFFICIENCY) is electronically governed. The automatic transmission also lets you change gear manually by tapping the selector lever towards the left or right. At the touch of a button you can select two transmission modes with which the transmission characteristics and shift points are determined: “E” mode for a consumption-optimised driving style and “S” mode for a sporty driving style.

**Transmission for 6- and 8-cylinder models:** the seven forward gears on the 7G-TRONIC transmission ensure that you always drive in the optimum engine speed range, which means that fuel consumption can be reduced. When overtaking or in situations requiring spontaneous pulling power, individual gears can be skipped. The transmission modes “E” and “S” are also selectable at the touch of a button for the 7G-TRONIC. In conjunction with the AMG Sports package and the Dynamic Handling package with a sports mode (option/standard for the E 500) there is an additional driving mode, “M”, for manual shifting with the aid of the steering-wheel gearshift paddles.

## Chassis and suspension

The E-Class Coupé and Cabriolet are tuned to both comfortable and sporty driving styles. The Dynamic Handling package increases fun at the wheel even further with its selectable suspension and transmission setups.

**AGILITY CONTROL package** (standard). With its selective damping system the suspension is constantly and variably adjusted to suit the road conditions and your driving style. In the case of weaker shocks it reduces the damping effect individually for each wheel and increases road roar and tyre vibration characteristics. When the vehicle encounters more pronounced uneven sections the system steps up the damping effect and can increase driving stability. In addition to this the steering has a more direct ratio and, in conjunction with the manual transmission, short shift travel means even more precise wheel control.

**AGILITY CONTROL sports suspension with speed-sensitive sports steering** (optional/standard in conjunction with AMG Sports package). In com-

parison with the standard-fit AGILITY CONTROL suspension the springs and shock absorbers of the AGILITY CONTROL sports suspension are more tightly tuned. This leads – especially when the driving style is dynamic – to reduced rolling motions and improves handling. The more direct steering ratio of the speed-sensitive sports steering supplements the suspension by enabling a more spontaneous transfer of the steering movements to the road.

**Dynamic Handling package** (optional/standard for the E 500). With the Dynamic Handling package a touch of the “SPORT” button is all it takes to switch the related systems from regular comfort mode to sports mode. Damping becomes noticeably tighter and the engine’s response to the accelerator pedal is much more direct. At

the same time the automatic transmission’s shift program changes to a more dynamic mode, ensuring optimum acceleration at all times. The speed-sensitive sports steering creates a sporty and direct steering sensation in both driving modes.

**ADAPTIVE BRAKE** (standard). This lends the E-Class Coupé and E-Class Cabriolet more ride comfort and safety. With the anti-lock braking system ABS it helps drivers to master critical braking manoeuvres. Thanks to the functions for “dry braking” in wet conditions and “priming”, the brakes react even more directly. When starting on an incline unintentional rolling back is prevented and if you press the brake pedal a second time the HOLD function keeps the vehicle securely in its place.





The Dynamic Handling package with its sports mode: decidedly sporty driving for more agile driving characteristics, further optimised vehicle control and improved handling at higher speeds

## Safe driving

Mercedes-Benz pursues a comprehensive safety philosophy: the integral safety concept. At its core lies the vision of accident-free driving. Numerous measures support the driver in critical situations and can help to prevent an accident.

**ATTENTION ASSIST** (standard). This drowsiness detection system is especially useful on long trips. At speeds of between 80 and 180 km/h, ATTENTION ASSIST warns the driver as soon as it detects signs of drowsiness or inattention. All thanks to sensors that analyse driving behaviour and can detect any changes compared with the driver profile individually determined previously.



If ATTENTION ASSIST detects signs of drowsiness, the system recommends a break

**Intelligent Light System** (optional). The system has four settings: the country mode illuminates the edge of the road, the extended fog lamp function improves visibility, and the active cornering light function follows the driver's steering angle. Also, Adaptive Highbeam Assist dims the headlamps, so that drivers of oncoming vehicles or of vehicles in front are not dazzled.

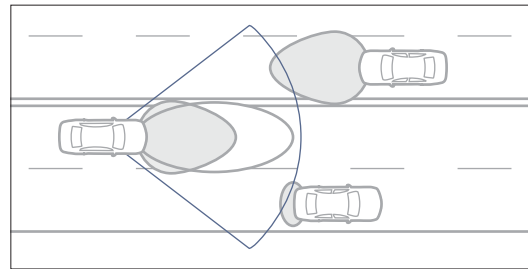

With Adaptive Highbeam Assist the transition between low and main beam is virtually seamless

**DISTRONIC PLUS** (optional). The DISTRONIC PLUS proximity control uses short-range and long-range sensors to maintain the desired safe distance to the vehicle in front. The system operates at speeds of between 0 and 200 km/h and is also helpful in city traffic or stop-and-go traffic as the sensors can operate in a range of between 0.2 and 200 metres.

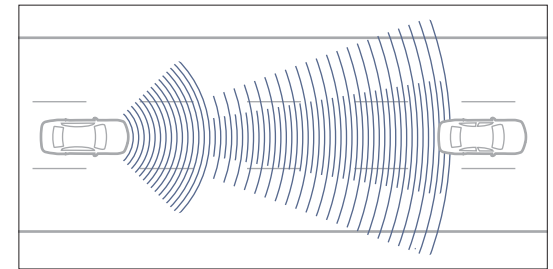

DISTRONIC PLUS supports drivers in automatically keeping their vehicle at a safe distance from the vehicle in front

**Blind Spot Assist** (optional). From 30 km/h the Blind Spot Assist uses two radar sensors to monitor the area obscured from view directly to the side of and behind the vehicle. It can warn the driver as soon as it detects the imminent risk of a collision with another vehicle when changing lanes.

**LED tail lights and adaptive brake lights** (standard). The tail and brake lights and the third brake light employ LEDs. In comparison with conventional lights they are significantly faster and emphasise the sporty design. During emergency braking the adaptive brake lights signal to following traffic through the flashing brake lights that there is a hazardous situation.



<sup>1</sup> Available from June 2010

The particularly fast LED tail lights and the adaptive brake lights are an important boost for perceptive safety

## In the event of danger or an accident

The integral safety concept from Mercedes-Benz ensures passengers' safety – during the journey, in case of danger and during and after an accident. The E-Class Coupé and Cabriolet are fitted with a system that can recognise driving situations which could result in an accident.

**PRE-SAFE® system** (standard). The anticipatory occupant protection system PRE-SAFE® can recognise critical driving situations and initiate preventive measures in order to protect the occupants. The safety belt can be electromotorically tensioned and the front passenger seat – in conjunction with the optional Memory package – moved to a more favourable position. In case of higher lateral dynamics the side windows and the coupé's optional panoramic sliding sunroof are also closed.

**PRE-SAFE® Brake** (part of the optional DISTRONIC PLUS package). As a three-stage warning and braking system the PRE-SAFE® Brake can intervene effectively prior to an impending rear-end collision: if there is no reaction from the driver following an initial visual

and acoustic warning, an autonomous brake application is initiated as a haptic warning. If there is still no reaction from the driver, the final step then involves the triggering of an autonomous full brake application, which reduces the severity of the impact.

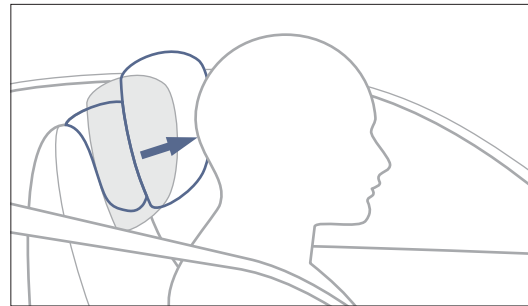

The NECK-PRO head restraints can reduce the risk of whiplash in a rear impact

**NECK-PRO head restraints** (standard). The NECK-PRO head restraints for the driver and front passenger can be activated in a rear impact: a spring mechanism moves forwards and upwards, the head can thus be supported earlier and the strain on the spine can be reduced.

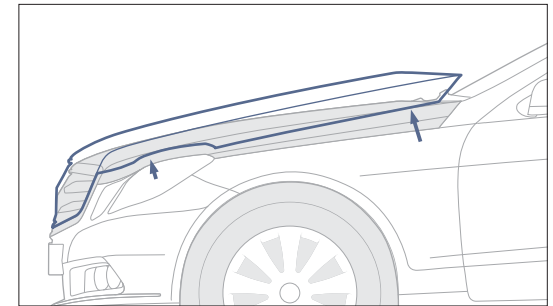

The active bonnet is part of the Mercedes-Benz protection system for weaker road users

**Active bonnet** (standard). The active bonnet can reduce the risk of injury to pedestrians or cyclists if they are involved in a collision with the bonnet. To better cushion the blow, the bonnet can raise approximately five centimetres at the rear by means of spring force.

**Airbags** (standard/optional). Integrated in the E-Class Coupé and Cabriolet are front airbags with two-stage deployment, pelvisbags and front sidebags. The coupé also has windowbags for all seats, and the cabriolet headbags for the driver and front passenger. In case of an accident the kneebag can protect the legs, especially the driver's knees, against injury. Rear sidebags are available as an option.



## Cabriolet safety

To enable its occupants to sit back and enjoy that wonderful sensation of freedom without any worries, the E-Class Cabriolet boasts protection systems specifically tailored to its particular design, such as roll-over protection meeting high technical and aesthetic standards.

**Safety body** (standard). Right from the outset the E-Class Cabriolet is designed with its occupants and their safety in mind – much of the body consists of high-strength and maximum-strength steel. The passenger compartment, in particular,



The airbags are physiologically tuned and offer effective all-round protection that meets the specific needs of the cabriolet

has cabriolet-specific reinforcement in the floor and side area. At the same time the high torsional strength and the lightweight construction provide the ideal basis for excellent driving dynamics.

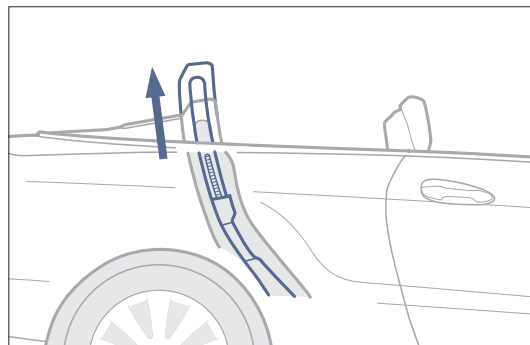

The integral roll-over bars are extended in just 0.3 seconds, during which time the rear head restraints move into the highest possible position

**Roll-over protection** (standard). The roof frame structure and the A-pillars are also built to be particularly stable. The A-pillars have been reinforced with tubing, offering effective occupant protection together with the roll-over bars in case of an overturn. The roll-over bars' cassettes are fully integrated in the head restraints on the rear seats and fastened to the area behind the rear seat backrest in the bodyshell. They can be extended in fractions of a second as soon as the airbag control system's crash sensors detect the risk of an accident.



In addition to the roll-over protection and roof frame, the use of different steel grades further increases safety in the E-Class Cabriolet

## Multimedia systems

The highest levels of comfort take centre stage. Whilst the COMAND APS multimedia system entertains and navigates, all the elements can be easily reached via the Controller, the multifunction steering wheel and the optional voice-operated control system LINGUATRONIC.

**Central colour display and Controller** (standard). Situated in front of the centre armrest, the Controller, operated intuitively, is used in combination with the central display for controlling the audio and multimedia functions. It adds to the numerous operating possibilities offered by the multifunction steering wheel.



Ergonomically optimum: the Controller is housed in front of the centre armrest

**COMAND APS** (optional). The COMAND APS multimedia system combines navigation, audio and telephone functions, showing the information you need in its colour display with a diagonal size of 17.8 cm. The integral DVD drive plays CDs and MP3 files plus video and audio DVDs. It can be operated via voice commands if LINGUATRONIC is ordered.



Three years of free navigation updates for your map data are included in the COMAND APS (from initial registration depending on vehicle)

**Harman Kardon® Logic 7® surround sound system** (optional). With 12 loudspeakers, including a subwoofer, this 450-watt Dolby Digital 5.1 system provides a first-class musical experience. The speed-dependent volume adjustment enhances the ease of operation even further.



The Harman Kardon® Logic 7® surround sound system automatically regulates the volume in accordance with the vehicle's speed



## Assistance systems

There are numerous assistance systems to provide relaxation on the road. Their job is to support the driver when driving, but also when performing difficult manoeuvres.

**PARKTRONIC including Parking Guidance** (optional). Parking Guidance helps when parking and finding a space. The system uses data from ultrasound sensors to determine whether a space is adequate, and provides instructions on the correct steering angle and the points at which to turn or reverse to park with just a few steering-wheel movements.



Parking Guidance indicates suitable parking spaces to the driver and provides parking directions

**Reversing camera** (optional). A reversing camera with a wide-angle rearview mirror shows what is behind the vehicle, which is particularly helpful when parking and reversing. The picture appears on the central display in the cockpit.



The reversing camera shows the area behind the tail end of the vehicle which is difficult to see

**Speed Limit Assist** (optional). The system boosts safety in that it can recognise traffic signs and show the speed limit on them in the cockpit. It is also capable of registering variable speed limit displays and speed limits put in place at short notice, such as for road works.



Speed Limit Assist can even warn you about temporary speed limits

## Open-air comfort

With its innovative technology the E-Class Cabriolet makes open-air driving comfort possible in just about every season. This is thanks to superb aerodynamics and the unique draught-stop system, from which the rear passengers also benefit, because the air turbulence and noise level are significantly reduced.

**AIRCAP** (optional). AIRCAP, an innovation, is an enhanced version of the conventional angled draught-stop. This innovative way of steering air flow over the heads of the vehicle occupants makes unrestricted use of the rear seats during open-top motoring possible for the very first time. AIRCAP consists of an air deflector module in the roof frame in combination with a small

draught-stop between the rear head restraints. Together they direct the airflow in an arc over the entire interior, without taking up any of the space on the rear bench seat. The result is open-air ride comfort for all four occupants: draughts and annoying turbulence are significantly reduced, and both communication between the front and rear occupants and climate control are easier.

The system can even be activated and retracted again at the touch of a button when driving at up to 160 km/h. When the vehicle stops it automatically retracts.

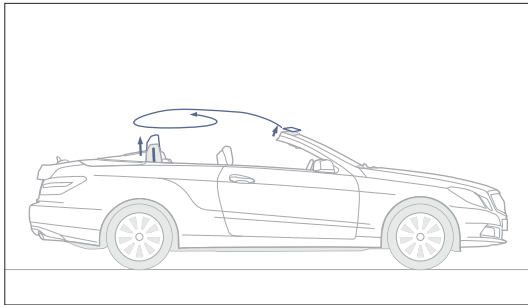

AIRCAP extends the flow curve over the passenger compartment, ensuring a controlled air supply in the rear



The electric air deflector module on the front of the roof frame is an integral part of AIRCAP



AIRSCARF has warm air aplenty to ensure perfect cabriolet pleasure even in cool weather

**AIRSCARF** (option). The neck-level heating developed by Mercedes-Benz extends the cabriolet season. At the touch of a button air is wrapped around the shoulders and neck of the driver and front passenger like a warming scarf. In order to achieve this effect the system draws in cold air before warming it and releasing it again through discreetly positioned vents in the head restraints.

**Aerodynamics.** In addition to a  $C_d$  value that is outstanding in its class (e.g. in the E 200 CGI BlueEFFICIENCY:  $C_d$  value = 0.28 when the soft top is closed), the E-Class Cabriolet is also characterised by excellent key data where the lift on the front and rear axle is concerned. Good aerodynamics are a prerequisite for high driving stability, the low noise level and the favourable fuel consumption.



The AIRCAP draught-stop system and the AIRSCARF neck-level heating are also available together as the Cabriolet Comfort package – for unrestricted open-air pleasure

## Soft top and space

The E-Class Cabriolet's fully electric soft top offers many advantages: it opens and closes up to a speed of 40 km/h and even when it is open it provides plenty of room for luggage. When closed it impresses with its quiet-running characteristics and good heat insulation.

**Automatic fabric soft top** (standard). If the engine is the heart of the E-Class Cabriolet, then the fabric soft top is its soul. It is available in four different colours, has been ingeniously designed both visually and technically, and it is immune to

the effects of inclement weather. It is easy to operate – by raising and holding the soft top switch – and the roof can be opened and closed at a speed of up to 40 km/h or, from outside at close range, via the infrared function in the key.

The electrohydraulic mechanism folds the soft top in such a way that there is still an optimum load compartment even during open-top motoring, making the cabriolet's boot capacity one of the most generous in its segment. Together with



The soft-top operating switch is positioned beneath the handrest for the Controller



Thanks to AIRCAP the rear passengers can also enjoy the journey to the full when the soft top is open



The cabriolet's boot offers plenty of stowage space whether the soft top is open or closed

AIRCAP this is a decisive factor when it comes to the E-Class Cabriolet's flexibility: not only does it carry four people – it also accommodates their luggage whatever the weather.

A further comfort feature in the E-Class Cabriolet is the low noise level in the interior. As well as the good soft top sealing and the aerodynamically efficient design of features such as the tail lights and the radiator shutter, targeted aerodynamics measures on the vehicle's body, detachable body parts and trim also reduce noise levels. A decisive contribution towards ride comfort – especially at high speeds.



## Climate control

An interior climate that can be adjusted to suit individual preferences enhances driving pleasure even further and increases driver-fitness safety. In the E-Class Coupé and the E-Class Cabriolet the temperature can be individually regulated for two or three zones.

**THERMATIC** (standard). The 2-zone automatic climate control THERMATIC automatically keeps the temperature constantly at the desired level for the driver and front passenger. Sensors record the interior and exterior temperatures and other data such as the intensity and direction

of sunlight, and for each of the two temperature zones individually adjust the heating, cooling or fan as necessary. The system also includes air recirculation, a defrost outlet for the windscreen and a particulate matter filter.

**THERMOTRONIC** (optional/standard for the E 500). The 3-zone luxury automatic climate control THERMOTRONIC has separate temperature controls for various parts of the interior, allowing the driver, front passenger and rear passengers to travel in comfort at the temperature of their choice. At the touch of a button the 3-zone system works fully automatically – in addition to individual temperatures the climate styles DIFFUSE, MEDIUM and FOCUS are available for selection. THERMOTRONIC keeps the desired temperature constant and also takes exterior factors such as sunlight, air quality and humidity into account via its sensors.



The luxury automatic climate control THERMOTRONIC can be operated both in the cockpit and via a control unit in the rear



## Seats

The seats combine seating comfort with ergonomics, safety and sportiness – both in the front and in the rear. Systems such as the automatic belt feeder and the rear entry aid add yet more comfort.



The front seats are ergonomically adjustable to ensure a relaxing journey

The front seats with standard-fit NECK-PRO head restraints are ergonomically shaped and give the driver and front passenger optimum support, even when the driving style is particularly dynamic. Their height and backrest angle can be electrically adjusted.

With the optional climatized seats the front seats are actively ventilated and heated. The multicontour seats (optional), which also offer ventilation and heating, feature integral inflatable air chambers. A lumbar support with two air chambers in the back area and in the seat side bolsters of the backrest plus a chamber for extending the seat cushion length ensure superb adjustment of the seat to your sporty and orthopaedic needs.



**Automatic belt feeders** (standard). To help with fastening the seat belt the automatic belt feeder brings the seat belt on the front seats into an easily accessible position. It can also be activated via a button on the upper dashboard.



The automatic belt feeder extends the seat belt

**EASY-ENTRY system** (standard). If rear passengers wish to get in or out of the car, the entire front seat is moved forwards. In conjunction with the optional Memory package (standard-fit for the E 500) the seats move into the EASY-ENTRY position and back again electrically.



The front seats fold forwards, allowing the rear passengers to get in and out of the vehicle easily

**Rear seats** (standard). The rear passengers take their seats on upholstery in an individual seat look with integral head restraints. The area between the seats features a stowage compartment and a double cup holder. The coupé's backrest can be folded so that bulky items can be transported with ease. Enhanced seating comfort in the rear of the cabriolet comes courtesy of a folding armrest, whilst the through-loading opening behind it makes loading the vehicle easier.



Comfortable individual seats await passengers in the rear

## Standard equipment for the coupé

Comfort, sportiness and a unique design come as standard with the E-Class Coupé, ensuring that it always makes a glowing impression.



The E-Class Coupé's standard equipment impresses inside and out: the exterior is embellished with daytime driving lights, LED tail lights and chrome trim strips. The interior, featuring trim in polished aluminium, boasts comfortable individual seats and a 3-spoke sports steering wheel.

---

### EXTERIOR

9-twin-spoke light-alloy wheels

Chrome trim strips, e.g. on front and rear bumper

Front fog lamps & daytime driving lights in twin circular design

Rear diffuser in the vehicle colour

---

### INTERIOR

3-spoke sports steering wheel & shift/sel. lever in nappa leather

ARTICO man-made leather/fabric upholstery

Door sill panel with Mercedes-Benz lettering & exit lighting

Electric height and backrest adjustment for front seats

Individual seats with integral head restraints & belt feeders

---

## Standard equipment for the cabriolet

There can surely be no other vehicle which brings that special feeling of freedom and flexibility to the road in such stunning fashion as the E-Class Cabriolet – as standard.



Striking forms and an exclusive range of equipment and appointments are distinguishing features of the E-Class Cabriolet – even in its standard guise. The classic fabric soft top, the characteristic headlamps and sporty light-alloy wheels are included, as are tail lights with an LED design and an interior that draws admiring glances even before the soft top is opened.

---

### EXTERIOR

5-twin-spoke light-alloy wheel (available as an option at no extra charge for 4- and 6-cylinder models)

Front fog lamps & daytime driving lights in twin circular design

High-quality fabric soft top in black, dark blue, dark beige or red

Tail lights with an LED design

---

### INTERIOR

3-spoke sports steering wheel & shift/sel. lever in nappa leather

ARTICO man-made leather/fabric upholstery

Electric height and backrest adjustment for front seats

Individual seats with integral head restraints & belt feeders

---



The ELEGANCE interior concept with a black backplate in the instrument cluster. For individualisation the upper part of the dashboard can also be adorned with nappa leather. Further leather appointments and trim are available in the designo range

## ELEGANCE

The ELEGANCE interior concept gives the E-Class Coupé a classic feel, with its tone-in-tone atmosphere, soft contrasts between the dashboard, steering wheel, the shift/selector lever and the light A and C-pillars and light roof liner.

---

### BLACK

711 ARTICO man-made leather/fabric<sup>1</sup>

201 Leather<sup>2</sup>

801 Nappa leather<sup>2</sup>

---

### ALPACA GREY

718 ARTICO/man-made leather/fabric<sup>1,3</sup>

208 Leather<sup>2</sup>

808 Nappa leather<sup>2</sup>

---

### ALMOND BEIGE

205 Leather<sup>2</sup>

805 Nappa leather<sup>2</sup>

---

### TRIM (freely combinable in the interior concept)

739 Polished light aluminium

731 High-gloss brown burr walnut wood<sup>2</sup>

H13 High-gloss brown pine wood<sup>2</sup>

H21 High-gloss black piano lacquer<sup>2,4</sup>

---

<sup>1</sup> Not in conjunction with AMG Sports package <sup>2</sup> Optional extra

<sup>3</sup> Only for E-Class Coupé <sup>4</sup> Not in combination with almond beige

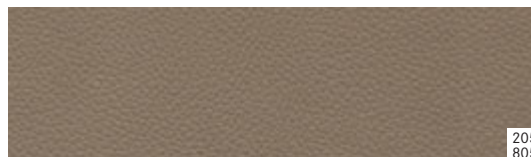
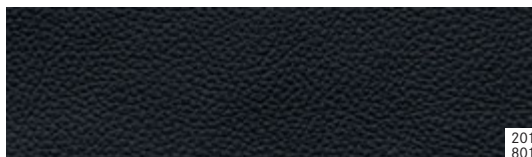



The AVANTGARDE interior concept with a silver-coloured backplate in the instrument cluster. For individualisation the upper part of the dashboard can also be adorned with nappa leather. Further leather appointments and trim are available in the designo range

## AVANTGARDE

The sporty AVANTGARDE interior concept impresses with its black theme featuring a roof liner and A and C-pillars in black.

---

### BLACK/BLACK

---

701 ARTICO man-made leather/fabric<sup>1</sup>

101 ARTICO man-made leather<sup>2</sup>

251 Leather<sup>3</sup>

851 Nappa leather<sup>3</sup>

---

### BLACK/ALPACA GREY

---

258 Leather<sup>3</sup>

858 Nappa leather<sup>3</sup>

---

### BLACK/ALMOND BEIGE

---

255 Leather<sup>3</sup>

855 Nappa leather<sup>3</sup>

---

### BLACK/NATURAL BEIGE

---

254 Leather<sup>3</sup>

---

### BLACK/FLAMENCO RED

---

257 Leather<sup>3</sup>

---

### TRIM (freely combinable in the interior concept)

---

739 Polished light aluminium

736 High-gloss black ash wood<sup>3</sup>

H21 High-gloss black piano lacquer<sup>3</sup>

---

<sup>1</sup> Not in conjunction with AMG Sports package    <sup>2</sup> Standard in AMG Sports package

<sup>3</sup> Optional extra

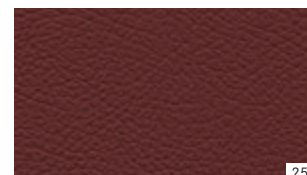
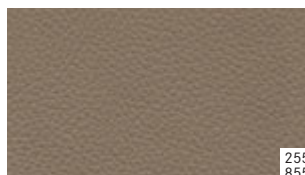
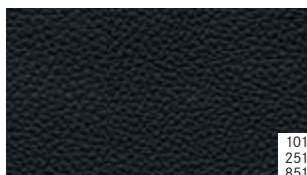

## AMG Sports package



The sporty appearance of the E-Class Coupé and the E-Class Cabriolet is rounded off perfectly by the AMG Sports package which is available as an optional extra. For the exterior, for example, there is a dynamic AMG front and rear apron, the powerful side sill panels, high-shine AMG 6-twin-spoke light-alloy wheels and large, perforated brake discs at the front with Mercedes-Benz lettering.

As an option, high-shine 5-twin-spoke or 7-twin-spoke AMG light-alloy wheels are also available.





---

**EXTERIOR**

---

6-twin-spoke AMG light-alloy wheels, high-sheen

---

AGILITY CONTROL sports suspension

---

AMG bodystyling, consisting of front apron with specific LED daytime driving lights, side sill panels and rear apron with black insert (tailpipes depending on model)

---

Large, perforated brake discs at the front and brake callipers with Mercedes-Benz lettering

---

Speed-sensitive sports steering with a more direct ratio

---



## AMG Sports package

The dynamic ambitions of the optional AMG Sports package are also very much in evidence in the interior: in the form of multicontour seats at the front in ARTICO man-made leather, for example, and the AMG sports steering wheel in nappa leather, floor mats with AMG lettering and sports pedals. What's more, all the leather and nappa leather upholsteries from the ELEGANCE and AVANTGARDE interior concepts plus the individual trim can be selected as an option.

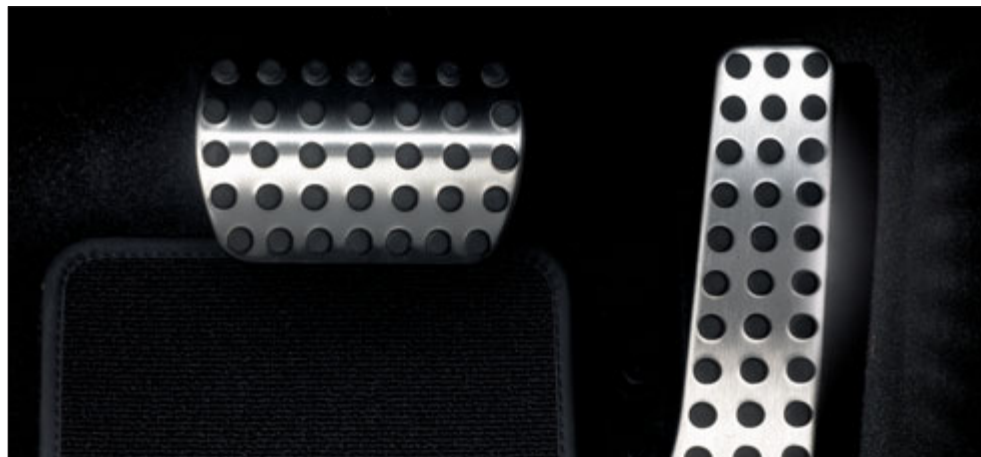

---

### INTERIOR

---

AMG sports steering wheel in nappa leather

---

ARTICO man-made leather upholstery, black with contrasting topstitching (leather and nappa leather and trim in wood or piano lacquer available as an option)

---

Brushed stainless-steel sports pedals with rubber studs

---

Floor mats with AMG lettering

---

Multicontour seats for driver and front passenger

---

Steering-wheel gearshift paddles in conjunction with automatic transmission

---



## designo

designo meets your extra-special requirements: with its exclusive leather appointments and trim. The Mercedes-Benz individualisation range provides an incomparable personal touch.

designo gives you the opportunity to inject maximum individuality into the E-Class Coupé and the E-Class Cabriolet. The carefully selected materials are handcrafted with meticulous precision, creating an unmistakable masterpiece. The single or two-tone designo seats with an individual upholstery layout and the door linings are covered in exclusive designo leather. Trim covered in leather adds even more elegance. The exclusivity continues on the exterior with a whole range of exciting paint colours. You can find further designo appointments and information at [www.mercedes-benz.com/designo](http://www.mercedes-benz.com/designo)



Seat in designo porcelain leather with a metal badge (Code W80)



Leather-covered trim in designo porcelain leather (Code X87)

## Standard equipment for the coupé and cabriolet | Selection



Proj.-beam headlamps, front fog lamps & daytime driving lights



Rain sensor & light sensor for Headlamp Assist



Soft-top operating switch for the cabriolet



Automatic climate control THERMATIC



Tyre pressure loss warning system



12-button multifunction steering wheel in nappa leather



Audio 20 CD



Belt feeder button on the upper dashboard

## Optional extras for the coupé and cabriolet | Selection



Intelligent Light System with LED daytime driving lights



Panoramic sliding sunroof for the coupé



AIRCAP (air deflector module) for the cabriolet



The neck-level heating AIRSCARF for the cabriolet



DISTRONIC PLUS proximity control



Voice-operated control system LINGUATRONIC with button on steering wheel



COMAND APS multimedia system



Memory package

## Wheels



9-spoke low-rolling-resistance wheel with 205/55 R 16 tyres (no extra charge for 4-cylinder or E 350 CGI BlueEFFICIENCY, Code R 12, coupé only)



5-twin-spoke light-alloy wheel with 235/45 R 17 front and 255/40 R 17 rear tyres (optional for 4- and 6-cylinder, Code R52)



9-twin-spoke light-alloy wheel with 235/45 R 17 tyres (standard for 4- and 6-cylinder, Code 31R)



5-twin-spoke light-alloy wheel with 235/45 R 17 tyres (no extra charge for 4- and 6-cylinder, Code R 11)



5-spoke light-alloy wheel with 235/40 R 18 front and 255/35 R 18 rear tyres (optional, Code R32, standard for 8-cylinder)





6-twin-spoke AMG light-alloy wheel with 235/40 R 18 front and 255/35 R 18 rear tyres, high-shen (Code 786, part of AMG Sports package)



7-twin-spoke AMG light-alloy wheel with 235/35 R 19 front and 255/30 R 19 rear tyres (optional, Code 770)



incenio "Khotrima" 5-twin-spoke light-alloy wheel! for 235/45 R 17 tyres, titanium silver, high-shen (accessory, optional with mixed-size tyres)



AMG 5-twin-spoke light-alloy wheel with 235/40 R 18 front and 255/35 R 18 rear tyres, high-shen (optional, Code 795)



incenio "Lugo" 10-spoke light-alloy wheel! for 215/55 R 16 tyres, sterling silver (accessory)



incenio "Shikrio"! 5-twin-spoke light-alloy wheel for 235/40 R 18 tyres, titanium silver, high-shen (accessory, optional with mixed-sized tyres)

<sup>1</sup> incenio light-alloy wheels are delivered without tyres



Alustyle basic carrier bars<sup>1</sup> with 450 roof box

## Genuine accessories

The Mercedes-Benz genuine accessories range offers everything you need to make the E-Class Coupé and Cabriolet even more practical: a whole host of accessory products perfectly tailored to the vehicle.

The Alustyle basic carrier bars help you keep your options open when transporting sports equipment and items of luggage. You can combine the basic carrier bars with a large variety of different roof attachments, such as the Mercedes-Benz roof boxes<sup>1</sup>, which are available in 330- and 450-litre versions. The “Comfort”

ski and snowboard rack enables you to transport six pairs of skis or four snowboards. There is also an array of products for the boot, including the shallow boot tub, made from food-safe material. And for iPod® and iPhone® users there is the iPod® Interface Kit, which can be used to integrate the MP3 player into your vehicle’s audio

system. It is operated via the multifunction steering wheel and the playlist is shown in the instrument cluster.

Further information on the range of Mercedes-Benz genuine accessories is available in our special brochure or from your Mercedes-Benz dealer.



Alustyle basic carrier bars<sup>1</sup> with ski- and snowboard rack



Mercedes-Benz iPod® Interface Kit



Boot tub, shallow

<sup>1</sup> Basic carrier bars and roof boxes only available for the coupé

## Services

**Mercedes-Benz Museum.** 125 years of automotive history in one place – this is what awaits you at the Mercedes-Benz Museum in Stuttgart. Experience the unique excitement, and embark upon a thrilling journey through time. Housed inside an architecturally impressive building, over 1500 exhibits on nine levels give you an insight into the unique tradition and powers of innovation of the Mercedes-Benz brand. See the world's first two automobiles in the shape of the Benz Patent-Motorwagen (motor car) and the Daimler motorised carriage – both from the year 1886. Two linked circuits take you from the beginnings of the automobile, past a series of unforgettable classics, through more than 100 years of motor racing history and, finally, on to a glimpse of what the future holds – in an area covering a total of 16,500 square metres. Enjoy the unique brand experience. We look forward to your visit. Further details can be found at [www.mercedes-benz-classic.com/museum](http://www.mercedes-benz-classic.com/museum)

**MercedesCard.** The card is your ticket to the Mercedes-Benz experience: four times a year, we will send you exciting details of a selected range of events and services, which we have put together exclusively for you. Then there is the Mercedes Magazine with its fascinating reports and articles. But the MercedesCard also has many other uses: as a VISA credit card, it is an internationally accepted means of payment. Plus it offers further benefits to provide you with peace of mind, such as insurance packages. You can also gain free entry to the Mercedes-Benz Museum simply by showing your VISA MercedesCard. Further details can be found at [www.mercedes-benz.de/mercedescard](http://www.mercedes-benz.de/mercedescard)<sup>1</sup>

**Mercedes-Benz Financial Services.** Mercedes-Benz stands for quality, innovation and safety – and the same applies to Mercedes-Benz Financial Services. Our innovative leasing and financing products are tailored to your financial needs and means, making it easy for you to secure the keys to your dream car. Once you are on the road, our insurance products offer you just the right level of protection on every trip. Finally, our service products ensure that your car is always in tip-top condition whilst keeping costs transparent and easily manageable. For a detailed quotation, please contact your Mercedes-Benz dealer, who will be glad to go through the latest financial offers and terms together with you.

**Mercedes-Benz mobility.** Your new car comes with the assurance of carefree driving, but if you should ever need help Mercedes-Benz Service24h is there for you. Just call the free-phone service hotline on 00800 1 777 7777<sup>2</sup>. The newly integrated telematics service Mercedes-Benz Contact<sup>3</sup> is even more customer-friendly: a touch of a button is all it takes to contact the Mercedes-Benz customer centre. If you wish, the relevant vehicle and position-related data can be transmitted at the same time, ensuring the shortest possible reaction time and rapid assistance. Also standard with your new car at no extra charge is the Mercedes-Benz Mobilo<sup>4</sup> mobility package. Whether you have lost your key, have had a breakdown which cannot be repaired immediately or if the vehicle is damaged due to an accident or vandalism, Mobilo ensures that you still reach your destination – anywhere in Europe. Whatever your problem, one thing is certain: you will soon be able to resume your journey.

**Service packages.** Vehicle-specific services allow you to put together an individual package for your Mercedes, including long-term protection against unforeseeable repair costs and high-quality servicing with genuine Mercedes-Benz parts. You can also count on the extensive network of Mercedes-Benz workshops, where you will receive the usual high standard of service for your Mercedes at a predictable, fixed price. Please ask your Mercedes-Benz dealer for further details.

**Test drive.** The unique feeling of driving a Mercedes cannot be put into words. Which is why we'd like to invite you to take a test drive. Simply visit [www.mercedes-benz.com](http://www.mercedes-benz.com) to locate the nearest Mercedes-Benz dealer in your country or region. We look forward to seeing you.

**Interactive Owner's Manual.** The website also offers an interactive tour, enabling you to take a closer look at your desired model. These informative clips are the ideal way to acquaint yourself with your dream car. You can view key functions in detail, gain an insight into the car's inner workings or look at the benefits of each model. For further details, go to:  
[www.mercedes-benz.de/owners-manual](http://www.mercedes-benz.de/owners-manual)

**Mobile internet.** Now you can access the entire world of Mercedes-Benz from your mobile phone. As well as an overview of all the passenger car models, there are insights into the entire brand world along with a wealth of entertainment offers and direct links to our range of services at [www.mercedes.mobi](http://www.mercedes.mobi)

<sup>1</sup> Information about the MercedesCard in Austria and Switzerland can be found on the Mercedes-Benz websites for these countries <sup>2</sup> Mobile phone rates vary according to service provider <sup>3</sup> Only in conjunction with a factory-fitted radio and switched-on mobile phone. For the cost of a call to the landline network <sup>4</sup> When the warranty has expired Mobilo can be extended by another year for a maximum of 30 years, provided that regular maintenance is carried out by your Mercedes-Benz service partner

## Coupé dimensions

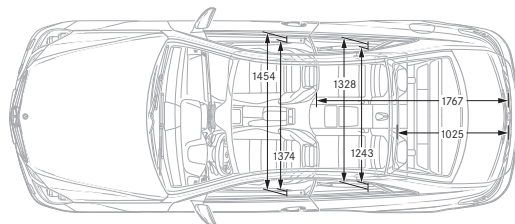
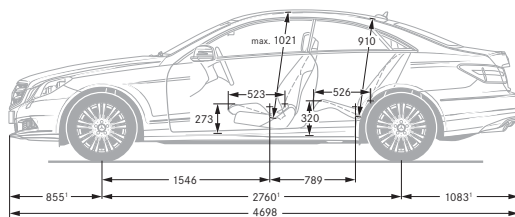
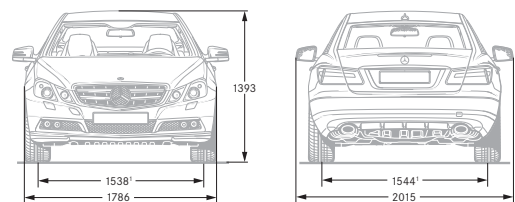

## Cabriolet dimensions

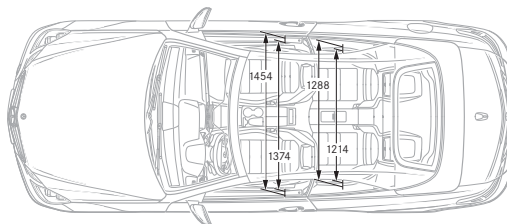
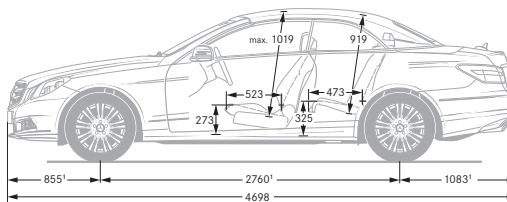
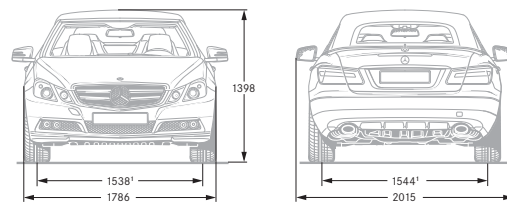

## Paintwork

The paints from Mercedes-Benz are particularly scratch-resistant with a durable, intensive shine.

### NON-METALLIC PAINTS (standard)

- 040 black
- 590 fire opal
- 650 calcite white

### METALLIC PAINTS (option)

- 197 obsidian black
- 230 indigolite blue
- 359 tanzanite blue
- 755 tenorite grey
- 775 iridium silver
- 792 palladium silver
- 798 sanidine beige
- 799 diamond white BRIGHT

### SPECIAL PAINT (option)

- 786 stannite grey

### SOFT-TOP FABRICS (cabriolet)

- 740 black
- 744 dark blue
- 745 dark beige
- 746 red

All measurements in millimetres. The dimensions shown are mean values and apply to standard-specification, unladen vehicles

<sup>1</sup> Carrying 3 people, each weighing 68 kg

You can find further individual paintwork variants in the designo range

# Technical data

## Coupé

No. of cylinders/arrangement
Total displacement (cc)
Rated output <sup>2</sup> (kW at rpm)
Rated torque <sup>2</sup> (Nm at rpm)
Acceleration from 0–100 km/h (s)
Top speed, approx. (km/h)
Tyre size, front
Tyre size, rear
Fuel
Fuel consumption <sup>4</sup> (l/100 km)
Urban
Extra-urban
Combined
CO <sub>2</sub> emissions <sup>4</sup> (g/km) combined
Emission class
Tank capacity (l)/incl. approx. reserve
Boot capacity (l)
Turning circle diameter (m)
Kerb weight <sup>5</sup> (kg)
Perm. GVW (kg)

### DIESEL ENGINES

E 220 CDI BE <sup>1</sup>	E 250 CDI BE <sup>1</sup>	E 350 CDI BE <sup>1</sup>
4/in-line	4/in-line	6/V
2143	2143	2987
125/3000–4200 (125/3000–4200)	150/4200 (150/4200)	– (170/3800)
400/1400–2800 (400/1400–2800)	500/1600–1800 (500/1600–1800)	– (540/1600–2400)
8.5 (8.5)	7.4 (7.4)	– (6.7)
235 (234)	250 <sup>3</sup> (247)	– (250 <sup>3</sup> )
235/45 R 17	235/45 R 17	235/45 R 17
235/45 R 17	235/45 R 17	235/45 R 17
Diesel	Diesel	Diesel
6.6–6.8 (8.1–8.3)	6.7–7.1 (8.1–8.3)	– (8.9)
4.2–4.6 (4.3–4.7)	4.2–4.7 (4.3–4.7)	– (5.6)
5.1–5.4 (5.7–6.0)	5.1–5.6 (5.7–6.0)	– (6.8)
133–142 (149–158)	135–148 (149–158)	– (179)
Euro 5	Euro 5	Euro 5
66/8	66/8	66/8
450	450	450
10.95	10.95	10.95
1660 (1670)	1695 (1690)	– (1730)
2130 (2140)	2165 (2160)	– (2180)

### PETROL ENGINES

E 200 CGI BE <sup>1*</sup>	E 250 CGI BE <sup>1</sup>	E 350 CGI BE <sup>1</sup>	E 500
4/in-line	4/in-line	6/V	8/V
1796	1796	3498	5461
135/5250 (135/5250)	– (150/5500)	– (215/6400)	– (285/6000)
270/1800–4600 (270/1800–4600)	– (310/2000–4300)	– (365/3000–5100)	– (530/2800–4800)
8.5 (8.3)	– (7.4)	– (6.5)	– (5.2)
240 (237)	– (247)	– (250 <sup>3</sup> )	– (250 <sup>3</sup> )
235/45 R 17	235/45 R 17	235/45 R 17	235/40 R 18
235/45 R 17	235/45 R 17	235/45 R 17	255/35 R 18
Premium petrol	Premium petrol	Premium petrol	Premium petrol
9.9 (10.5–10.7)	– (10.6–10.9)	– (12.3–12.4)	– (16.1)
5.4–5.9 (5.6–6.1)	– (5.7–6.2)	– (6.3–6.6)	– (7.8)
7.1–7.4 (7.4–7.8)	– (7.5–7.9)	– (8.5–8.7)	– (10.9)
164–171 (174–182)	– (175–183)	– (199–203)	– (254)
Euro 5	Euro 5	Euro 5	Euro 5
66/8	66/8	66/8	66/8
450	450	450	450
10.95	10.95	10.95	11.20
1560 (1560)	– (1575)	– (1670)	– (1715)
2030 (2030)	– (2045)	– (2140)	– (2180)

Figures in brackets refer to vehicles with an automatic transmission \*From June 2010 the E 200 CGI BlueEFFICIENCY is available with a 6-speed manual transmission and the ECO start/stop function <sup>1</sup>BlueEFFICIENCY <sup>2</sup>Figures according to 80/1269/EEC in the currently applicable version <sup>3</sup>Electronically governed <sup>4</sup>The figures shown were obtained in accordance with the prescribed measuring process (Directive 80/1268/EEC in the currently applicable version). The figures are not based on an individual model and

# Technical data

## Cabriolet

No. of cylinders/arrangement
Total displacement (cc)
Rated output <sup>2</sup> (kW at rpm)
Rated torque <sup>2</sup> (Nm at rpm)
Acceleration from 0–100 km/h (s)
Top speed, approx. (km/h)
Tyre size, front
Tyre size, rear
Fuel
Fuel consumption <sup>4</sup> (l/100 km)
Urban
Extra-urban
Combined
CO <sub>2</sub> emissions <sup>4</sup> (g/km) combined
Emission class
Tank capacity (l)/incl. approx. reserve
Boot capacity (l)/roof open
Turning circle diameter (m)
Kerb weight <sup>5</sup> (kg)
Perm. GVW (kg)

### DIESEL ENGINES

E 220 CDI BE <sup>1</sup>	E 250 CDI BE <sup>1</sup>	E 350 CDI BE <sup>1</sup>
4/in-line	4/in-line	6/V
2143	2143	2987
125/3000–4200 (125/3000–4200)	150/4200 (150/4200)	– (170/3800)
400/1400–2800 (400/1400–2800)	500/1600–1800 (500/1600–1800)	– (540/1600–2400)
8.8 (8.9)	7.8 (7.8)	– (6.9)
232 (230)	245 (243)	– (250 <sup>3</sup> )
235/45 R 17	235/45 R 17	235/45 R 17
235/45 R 17	235/45 R 17	235/45 R 17
Diesel	Diesel	Diesel
6.9–7.0 (8.3–8.5)	7.3–7.4 (8.3–8.5)	– (9.1)
4.6–4.8 (4.7–5.0)	4.7–4.9 (4.7–5.0)	– (5.9–6.1)
5.4–5.6 (6.1–6.3)	5.6–5.8 (6.1–6.3)	– (7.0–7.2)
143–148 (159–165)	148–153 (159–165)	– (185–189)
Euro 5	Euro 5	Euro 5
66/8	66/8	66/8
390/300	390/300	390/300
11.0	11.0	11.0
1785 (1795)	1815 (1810)	– (1845)
2255 (2265)	2285 (2280)	– (2295)

### PETROL ENGINES

E 200 CGI BE <sup>1*</sup>	E 250 CGI BE <sup>1</sup>	E 350 CGI BE <sup>1</sup>	E 500
4/in-line	4/in-line	6/V	8/V
1796	1796	3498	5461
135/5250 (135/5250)	– (150/5500)	– (215/6400)	– (285/6000)
270/1800–4600 (270/1800–4600)	– (310/2000–4300)	– (365/3000–5100)	– (530/2800–4800)
8.8 (8.6)	– (7.8)	– (6.8)	– (5.3)
236 (231)	– (240)	– (250 <sup>3</sup> )	– (250 <sup>3</sup> )
235/45 R 17	235/45 R 17	235/45 R 17	235/40 R 18
235/45 R 17	235/45 R 17	235/45 R 17	255/35 R 18
Premium petrol	Premium petrol	Premium petrol	Premium petrol
10.1–10.3 (11.0–11.2)	– (11.0–11.2)	– (12.8–12.9)	– (15.9)
5.8–6.1 (6.1–6.4)	– (6.1–6.4)	– (6.5–6.6)	– (8.2)
7.4–7.6 (7.9–8.2)	– (7.9–8.2)	– (8.8–9.0)	– (11.0)
172–177 (185–190)	– (185–190)	– (206–208)	– (257)
Euro 5	Euro 5	Euro 5	Euro 5
66/8	66/8	66/8	66/8
390/300	390/300	390/300	390/300
11.0	11.0	11.0	11.0
1685 (1685)	– (1695)	– (1790)	– (1840)
2155 (2155)	– (2165)	– (2260)	– (2295)

do not constitute part of the product offer; they are provided solely for purposes of comparison between different vehicle models <sup>5</sup> Figures according to Directive 92/21/EC, version 95/48/EC (kerb weight with fuel tank 90% full, driver, 68 kg, and luggage, 7 kg) for standard-specification vehicles. Optional extras and accessories will generally increase this figure and reduce the payload accordingly



NON-METALLIC PAINTS

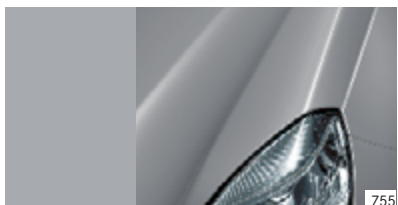
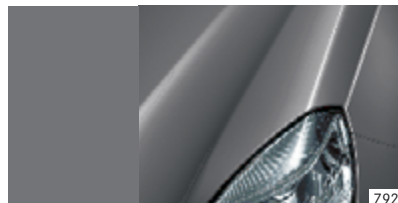

METALLIC PAINTS



SPECIAL PAINT FINISH

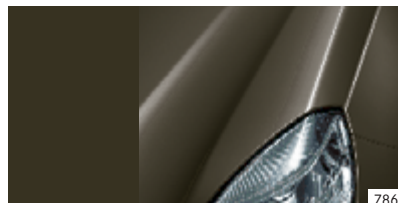

SOFT-TOP FABRIC

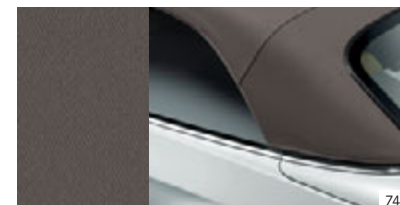

**Take-back of end-of-life vehicles.** Coming full circle. At the end of its long life, you can return your E-Class to us for environment-friendly disposal in accordance with the EC End-Of-Life Vehicle Directive<sup>1</sup>. But that day lies a long way off.

<sup>1</sup> Applies in accordance with national regulations to vehicles up to 3.5 tonnes gross weight. Mercedes-Benz passenger cars have met the statutory regulations governing the suitability of their design for reuse and recycling for a number of years now. A network of vehicle take-back depots and dismantlers has been established which will process your vehicle in an environment-friendly manner. The ways in which both vehicles and parts can be recovered are subject to ongoing development and improvement. Consequently, the E-Class will be able to comply with any future increases in the recycling quota within the stipulated time limits. For further information, please go to [www.mercedes-benz.com](http://www.mercedes-benz.com)

**Please note:** changes may have been made to the product since this brochure went to press (29.07.2010). The manufacturer reserves the right to make changes to the design, form, colour and specification during the delivery period, provided these changes, while taking into account the interests of the vendor, can be deemed reasonable with respect to the purchaser. Where the vendor or the manufacturer uses symbols or numbers to describe an order or the subject of an order, no rights may be derived solely from these. The illustrations may show accessories and items of optional equipment which are not part of standard specification. Colours may differ slightly from those shown in the brochure, owing to the limitations of the printing process. This brochure is distributed internationally. It provides a general indication of the range of models, features, optional extras and/or colours available in various countries. Some of the models, features, optional extras and/or colours shown may not be available in your country or may only be available in a different specification. Additionally some models, features, optional extras and/or colours may only be available in combination with others. For current and more specific information in relation to the range of models, features, optional extras and/or colours available in your country, and their pricing, you should contact your nearest authorised Mercedes-Benz Passenger Car Dealer.  
[www.mercedes-benz.com](http://www.mercedes-benz.com)