

This Brochure is prepared by Daimler AG and it predominantly reflects the capabilities and performance of vehicles sold in Europe. Some characteristics, capabilities, performance features and optional extras (e.g. towing systems) may not be available or may not apply in Australia or under Australian conditions. The information in this Brochure is therefore indicative, illustrative and provided only for guidance and should not be relied on. To obtain current and accurate information on a vehicle and any options applicable to Australia, contact your local authorised Mercedes-Benz dealer.



Mercedes-Benz

The new Viano. TREND & AMBIENTE.



Mercedes-Benz

Space galore!

Contents

The new Viano	5	Equipment	42
		Standard equipment	44
Comfort	12	Special equipment	48
Adaptability	12	Genuine accessories	52
Suspension	14		
		Colours and materials	54
Safety	16	Paintwork	54
		Upholstery, leather and trim elements	56
Design and equipment		Combination options	57
lines and length concept	20		
Viano TREND	22	Technical data	58
Viano AMBIENTE	28	Engine data and weights	58
		Dimensions	60
Agility	34		
Engines and transmissions	36	Glossary	62
BlueEFFICIENCY	38	Services	64
4MATIC	40	Test drive	68

The new Viano. Freedom to follow your lifestyle

Thanks to Albert Einstein, we all know that space is relative. Now the new Viano is here to prove that space can also be comfortable, efficient and eco-friendly. Its amply proportioned and adaptable interior grants you all the freedom of mobility you are seeking. State-of-the-art engines combine with the standard BlueEFFICIENCY package¹ to redefine standards for economy and sustainability – but without forsaking driving pleasure. Enjoy every metre of the journey at the wheel of your new Viano.

¹ Not available in conjunction with petrol engine



A shining example of successful family planning

The new Viano is ready equipped with everything that a fully-fledged family car needs. With room for up to eight people and a highly flexible passenger compartment, it boasts all the right credentials for trips to the world's essential destinations: from nursery schools and football pitches to shopping centres to holiday homes and amusement parks. And, of course, it comes with the qualities that have always been the hallmark of Mercedes-Benz: an extensive safety package, excellent comfort and exemplary functionality.



Impressive all-round versatility

Our free time is our most precious time, but unfortunately life isn't all play, so we've given the new Viano a wealth of other virtues besides. Thanks to its new comfort suspension, the vast array of equipment features and an interior that now has an even higher-quality feel to it, the Viano isn't just an outstanding family car; it also makes an excellent shuttle vehicle, company car or tourer. The restyled front and rear sections also do their bit by injecting the Viano with an added air of dynamism and prestige.

Despite all this comfort, however, the practical aspects have by no means been neglected: compact dimensions plus a clear view out of the vehicle make the Viano easy to park and manoeuvre, and enable you to access all standard garages, car washes and multi-storey car parks.







“Are we nearly there yet?”

“Yes.”

“Oh, what a pity!”





Comfort the easy way

The adaptable interior concept

Travelling in the Viano is a relaxing experience. Luxurious comfort seats, a light, airy feel as well as plenty of freedom of movement combine to keep everyone aboard in good spirits on even the longest journeys. This is all down to an interior concept that is as intelligent as it is flexible. At its heart is a rail system, which the comfortable seats and bench seats can be moved along in 25-mm increments. Apart from being extremely

safe and easy to use, this system permits an almost limitless number of seating permutations, which can be adjusted to suit your requirements whenever you wish. Rearranging the rear seats to face each other is straightforward too, allowing passengers to converse with one another with ease during the journey. The backrest angle of the seats can also be adjusted, allowing the occupants to truly sit back and relax. And if you ever

need extra load space, individual seats can be removed from the passenger compartment without the need for tools: all you have to do is fold the seat into the package position, release the catch and lift the seat out of the rail guide.

The individual seats and bench seats can be adjusted extremely easily in steps of 25 mm



The comfort seats in the Viano can also be “wrapped up” into a space-saving package position

Floating along on cloud nine

The new comfort suspension

The Viano has always been renowned for its dynamic, comfortable and, above all, safe handling. The pleasant all-round driving sensation can be attributed not least to the rear air suspension with electronic self-levelling (standard for Viano AMBIENTE) as well as the Electronic Stability Program ESP®, which can also be specified with ESP® Trailer Stability Assist built in as an option. Ride comfort has now been given a further boost by the newly developed comfort suspension, featuring a new spring and damper set-up as well as new wishbones and comfort mountings. The results of this are both audible and tangible, as it reduces noise levels at the same time as improving tyre vibration characteristics.



The rear air suspension enhances ride comfort and maintains a virtually constant ride height regardless of the load being carried – even when towing a trailer







A safe haven for your little treasures

To make sure you can get all your passengers, both large and small, to their destination with complete peace of mind, we have devised a coherent all-round safety concept for the Viano. It is based on a safety body with a high-strength passenger cell accompanied by a host of sensible safety components. These include three-point seat belts on all seats, belt tensioners for the front seats and a seat belt reminder. A driver airbag is standard as is a front passenger airbag with seat occupancy sensor. Even more extensive airbag protection is available in the form of optional windowbags for the driver and front passenger and thorax bags¹. In order to maximise active safety, the Viano comes equipped with all the essential electronic driver assistance systems.

¹ Standard on the Viano AMBIENTE, thorax bags not available in conjunction with swivelling seats



When you need help most, we'll be there for you

The standard-fit adaptive brake lights alert traffic behind to emergency braking more effectively by flashing in such situations. In the event of an emergency stop, the hazard warning lights come on automatically when the vehicle comes to a standstill



The optional automatic tyre pressure monitoring system can help to avoid tyre damage and its potentially serious consequences by warning the driver when a significant drop in pressure is detected in the tyres



The new bi-xenon headlamps with integrated cornering light function, fog lights and LED daytime driving lights (standard on Viano AMBIENTE) do more than just illuminate the carriageway and surrounding area more effectively: when you indicate to turn, the front fog lamp on the corresponding side of the vehicle comes on (cornering light function), as it does if the steering is turned beyond a certain angle in a bend (Add-Light System)



Just take as much Viano as you'd like

Two design and equipment lines, three lengths, virtually boundless possibilities

Not only does the new Viano offer you freedom of mobility in abundance, it gives you plenty of freedom of choice too. First, there are the two design and equipment lines, TREND and AMBIENTE, which each bestow a distinctive character on the Viano in their own individual way. Besides this, however, each of the two lines can be tailored to

your individual preferences and space requirements. You have a choice of three body lengths in all: compact, long and extra-long. When the numerous equipment options are added to the equation, the result is countless possible configurations – and, ultimately, a Viano which is perfectly moulded to your lifestyle.



Compact (length 4763 mm)



Long (length 5008 mm)



Extra-long (length 5238 mm)





Ready to explore
life with you

The Viano TREND







4x4

12V

For a greater sense of wellbeing on your travels

The new Viano TREND

Eating up the miles in the new Viano TREND is now more enjoyable than ever. A whole series of detail enhancements have brought about a further substantial improvement in the interior's feel and ease of operation. You ride in seats covered in an even higher-quality upholstery, read information off a high-contrast matrix display and can sense the workmanship that went into crafting the new controls. Then there is the atmospheric ambient lighting and the generous use of soft carpeting to make the passenger compartment more pleasing to the eye and more appealing to the touch.

To say that passengers enjoy a generous sense of spaciousness while travelling in one of the six individual comfort seats aboard the new Viano TREND would be an understatement. Capacity can even be increased to eight by opting for bench seats in the rear instead. The interior is very comfortable as it is, but can be further enhanced

by the addition of special equipment features, such as a tilting/sliding glass sunroof in the front as well as a panoramic roof for the passengers in the rear. And to accommodate all the luggage that adventurous travellers usually take with them too, there is up to 4610 litres of luggage space (depending on the body variant), along with all manner of handy stowage spaces and compartments.



There have been some great new developments

The new Viano TREND

With its improved controls, such as the new multifunction steering wheel, the Viano TREND now scores even more highly for design, functionality and comfort. The model line's identifying features include the cockpit decor strip with special "silverstone" finish



The seats in the Viano TREND are upholstered as standard in the Leon fabric, which is pleasant on the skin and available in the colour variants orion grey, stone and now in anthracite too. High-quality Lugano leather appointments with fluting on the seat centre sections are available as an option

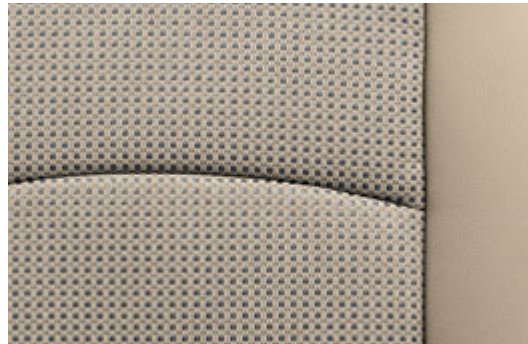

The new overhead control panel in the front catches the eye with its polished surfaces and built-in controls for the rear heating and rear air conditioning (special equipment). This now allows these systems to be operated by the driver too





A lively travelling
companion

The Viano AMBIENTE







Its most important asset is its sense of style

The new Viano AMBIENTE

Instantly recognisable from afar by its new light-alloy wheels with 225/55 R 17 tyres, the new Viano AMBIENTE pampers its occupants with a tastefully designed interior featuring high-class materials. Upon opening their doors, the driver and front passenger are welcomed by illuminated entrances and soft carpeting. Leather covers all six individual seats, the new-look 4-spoke multifunction steering wheel, the restyled shift lever as well as parts of the inner door panelling. The standard Lugano leather upholstery with fluting on the seat centre sections makes a particularly elegant impression.

The electrically adjustable and heated exterior mirrors with integral indicators now afford a larger field of vision. Elegant decor strips in a choice of a light or dark burr-walnut-effect design add an extra touch of class to the cockpit's high-quality surfaces. Meanwhile, the centre console offers plenty of stowage space as well as the added

convenience of cup holders. The standard equipment list for the Viano AMBIENTE also includes thorax bags for driver and front passenger, plus a self-levelling rear air suspension.



An air of sophistication

The new Viano AMBIENTE

The new light-alloy wheels with 225/55 R 17 tyres make quite an impression with their sporty 5-spoke styling, giving added impact to the dynamic, elegant looks of the Viano AMBIENTE



The centre console, shift lever knob and cockpit decor strip boast an exclusive burr-walnut-effect design in the Viano AMBIENTE, with the choice of a light or dark finish. The leather appointments are standard



In addition to front airbags for driver and front passenger, the Viano AMBIENTE also comes equipped with two thorax bags as standard





There are places where you're happy
the filling station isn't one of them



to spend a little extra - but



We thrive on efficiency

The engines for the new Viano

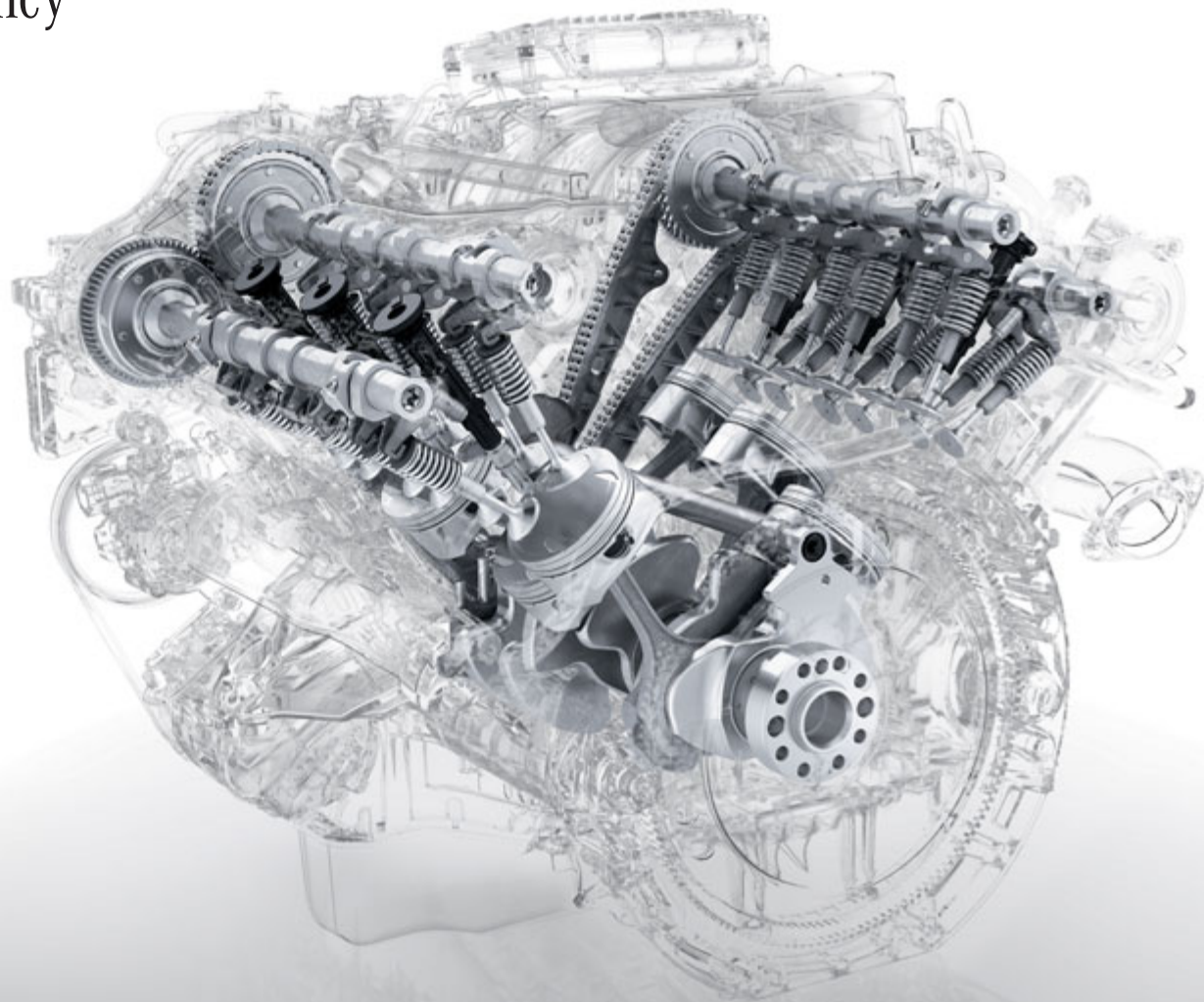

You have a choice of three fuel-efficient CDI diesel engines for your Viano which each take power output and power build-up to a whole new level. The newly developed OM 651 4-cylinder CDI engine is available in two power ratings which both inject an added dose of dynamism. Topping the diesel range is the OM 642 V6 CDI unit, which has also had its power increased and now musters up 165 kW and a peak torque of 440 Nm to effortlessly handle even the toughest jobs. All three CDI diesel models meet the requirements of the EU 5/III emissions standard. Their far lower fuel consumption, reduced exhaust emissions and even smoother operation clearly set them apart from the previous engines. As an alternative to the CDI diesel engines, there is also a 3.5l V6 petrol unit with an output of 190 kW, which now fulfils the EU 5/I emissions standard.

Like the V6 petrol unit, the V6 CDI diesel is partnered by the proven 5-speed automatic transmission as standard (available as special equipment for 4-cylinder CDI diesel models)



The ideal counterpart for the 4-cylinder CDI diesel engines is the newly developed ECO Gear 6-speed manual transmission. This helps to further lower fuel consumption thanks to a greater transmission spread, a broader overall gear ratio range and the reduction in engine speed levels

A close-up, low-angle shot of the side of a white car. The focus is on a badge that reads "BLUE EFFICIENCY" in white capital letters on a blue background. The car's body panels are smooth and reflective, with a bright light source from the upper right creating a lens flare and casting soft shadows. The background shows a clear blue sky with a few wispy clouds.

BLUE EFFICIENCY

BlueEFFICIENCY

Innovations for sustainable mobility

For Mercedes-Benz, responsibly shaping the long-term future of mobility is both an aspiration and a duty. The way forward is called BlueEFFICIENCY – a package of intelligently combined, innovative technologies that help to significantly cut fuel consumption and pollutant emissions. In the new Viano 4-cylinder and V6 CDI diesel models you are now able to experience the concrete benefits of this for yourself – without having to compromise on safety, comfort and driving pleasure. The various measures which form part of the standard BlueEFFICIENCY package¹ include:

- ▶ Economical 4-cylinder CDI diesel engine in 2 new power ratings
- ▶ State-of-the-art V6 CDI diesel engine (with automatic transmission)
- ▶ Fuel-saving ECO Gear 6-speed manual transmission²
- ▶ The inclusion of additional fuel-economy measures depending on the particular model variant (e.g. ECO start/stop function², shift point indicator², ECO power steering pump, internal engine measures, battery management, regulated fuel pump and lower rolling resistance tyres)

¹ Not available in conjunction with petrol engine

² Omitted in conjunction with automatic transmission

Effortlessly gets through thick and thin.
And wet and slippery. And icy and steep

The Viano with 4MATIC permanent all-wheel drive!



If you and your Viano frequently have to contend with adverse weather and road conditions, then the optional 4MATIC permanent all-wheel drive¹ could be just what you need. This system directs the engine's power to all four wheels simultaneously, with a 35 : 65 split between the front and rear axles. The result is noticeably superior traction, even when driving on snow or loose leaves, on poorly kept roads, in the wet or when towing a trailer. The 4MATIC is assisted in its task by the Electronic Stability Program (ESP®) as well as

4ETS, the Electronic Traction System. The 4ETS cuts in when one or more wheels start to spin, applying the brakes individually at the spinning wheels and thereby increasing the drive torque at the wheels which still have sufficient grip. This enables the vehicle to pull away and accelerate quickly with ease, especially on poor road surfaces. And because the 4ETS is integrated into the standard-fit ESP® on the Viano, the 4MATIC system works even more effectively.

¹ Available for the Viano CDI 2.0 and CDI 2.2. All-wheel drive is not available in all countries

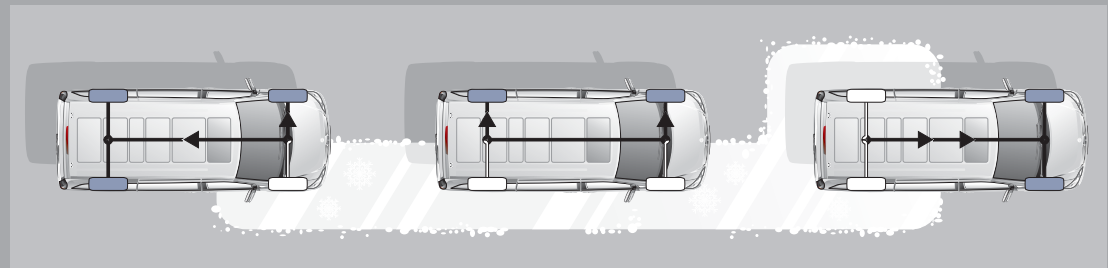

4ETS. Instead of having mechanical differential locks, the 4MATIC models work using the Electronic Traction System (4ETS). This automatically directs the drive torque to the wheels that have the best grip on the road







Standard equipment

5-speed automatic transmission for V6 CDI diesel engine and petrol engine

Adaptive brake lights

Additional heat exchanger in rear with separate control unit

Airbags for driver and front passenger with emergency fuel shut-off

ASSYST service computer

BlueEFFICIENCY package for 2.0, 2.2 and 3.0 CDI diesel engines

Body-coloured bumpers, rub strips and door handles

Comfort seats for driver and front passenger, manually adjustable

Diesel particulate filter

Disc brakes at all wheels

Driver and front passenger sun visors, illuminated mirrors

ECO Gear 6-speed manual transmission for 2.0 and 2.2 CDI diesel engines

Electronic brake force distribution (EBD)

Electronic Stability Program (ESP®) including anti-lock braking system (ABS), acceleration skid control (ASR) and Brake Assist (BAS)

ESP® Trailer Stability Assist in conj. with optional trailer coupling or trailer coupling pre-fittings

Extended central locking with radio remote control

Handle with reading lamp and ambient lighting

Heated exterior mirrors, electrically adjustable, with aspherically curved mirror glass and integral indicators

Multifunction steering wheel

Outside temperature display

Power steering with safety steering column

Power vent windows, left and right for 2nd rear seat row

Power windows for driver and front passenger, with one-touch control and obstruction sensor

Reflector headlamps with enlarged reflectors, fog lights and daytime driving lights with separate light source¹

Seat rail system

Steering column adjustable for height and reach

Tailgate with wash/wipe system

TEMPMATIC air conditioning system

Three-point seat belts for all seats, with belt tensioners and belt force limiters for driver and front passenger

Tinted glass all round

¹ Not available for the Viano AMBIENTE

Illustration shows bumper and radiator grille in new design – for an even more dynamic look



Exterior mirrors with enlarged field of vision and integral indicators, electrically adjustable



Design highlight: the new tail light clusters



Airbags for driver and front passenger¹



Adaptive brake lights



Reflector headlamps with integrated fog lights and daytime driving lights (standard on TREND)



ECO Gear 6-speed manual transmission for 2.0 and 2.2 CDI

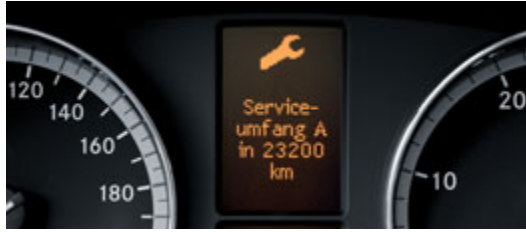

ASSYST service computer



High-resolution matrix display



Steering wheel adjustable for height and reach



The seat rail system for flexible arrangement of the interior



Power windows, vent windows and electrical exterior mirrors



TEMPMATIC electronically controlled air conditioning system



Additional heat exchanger for rear with separate control unit

1 The picture on page 46 (bottom left) shows various activated airbags at maximum deployment for illustrative purposes only



Special equipment

2-seater comfort bench seat

3-seater comfort bench seat, with EASY-ENTRY function (foldable right-hand outer seat)

4MATIC all-wheel drive¹

Additional sliding door on left-hand side

Anti-theft alarm system (ATA)

Automatically dimming interior mirror

AUX interface in glove compartment, e.g. for MP3 player

BIKE/LIFE²/BUSINESS equipment packages³

Black-tinted rear windows

Convenience Telephony package with exterior aerial and mobile-specific cradle (accessory)

Driver's and front passenger seats electrically adjustable (for fore/aft position, height and seat cushion angle as well as height of head restraint) with 3 memory settings

Electric sliding door

Electrically folding exterior mirrors

Floor net for luggage compartment

Headlamp cleaning system⁴

Illustration on page 48 shows bi-xenon headlamps⁴ with cornering light function, fog lights and LED daytime driving lights

Light and rain sensor

LINGUATRONIC: voice-operated control system for telephone

Radio and communication systems including navigation system, CD changer and sound system

Retractable luggage compartment cover and retaining net

Roof rails

Sliding windows, left and right for 1st rear seat row

Start-off Assist (for manual models)

TEMPMATIC air conditioning for rear with separate control unit

THERMOTRONIC automatic climate control

Trailer coupling

Valuables compartment under front passenger seat

Windowbags for driver and front passenger

¹ Available for the Viano CDI 2.0 and Viano CDI 2.2, only in conjunction with automatic transmission

² Only available for the compact and long versions

³ Further information can be found on our internet sites

⁴ Standard on the Viano AMBIENTE



5-spoke light-alloy wheels with 225/55 R 17 tyres (standard on Viano AMBIENTE)



Additional sliding door for the driver's side



The distinctively styled light-alloy wheels with 245/45 R 18 tyres



The automatic tyre pressure monitoring system

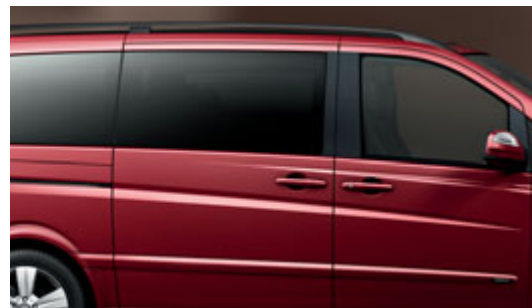

The tinted glass protects the rear compartment from prying eyes



Sound 50 APS radio/navigation system



Cruise control with SPEEDTRONIC variable speed limiter



Electric tilting/sliding rear sunroof

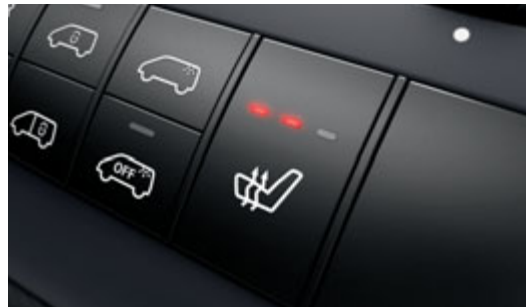

Heated seats for driver and front passenger



Electrically adjustable seats with 3 memory settings



0123 456789

1	2 ABC	3 DEF
4 GHI	5 JKL	6 MNO
7 PQRS	8 TUV	9 WXYZ
* +	0 +	#

+ Person Phone Message

Favorites Recent Contacts App Store Voice Mail



The right genuine accessories for an action-packed lifestyle

The accessories ideas from Mercedes-Benz allow you to further individualise your Viano to fulfil your exact needs. Mercedes-Benz genuine accessories¹ are optimised to suit your vehicle, and they meet the most stringent of requirements in terms of quality and safety. Further information and details of the entire product range can be found in our accessories brochures.

Cradles for mobile phones². Matching cradles are available for all popular mobile phone models which form a link between your mobile phone and the phone console. The cradles ensure optimum speech quality and ergonomic ease of operation, and can be fitted without paying a visit to the workshop

¹ The illustrations may show genuine accessories that are not available in all countries

² Picture shows similar product. The mobile phone illustrated is not supplied

³ The Mercedes-Benz Interface Kit allows music to be played via the iPod® application of your iPhone®. The telephone function is not supported

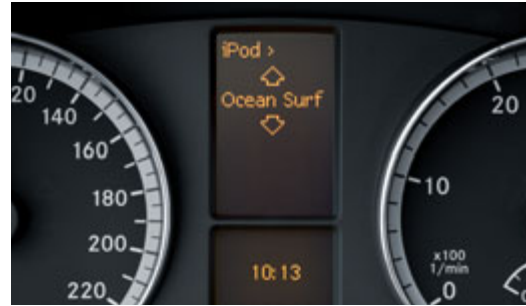

Mercedes-Benz iPod® Interface Kit³. Control your iPod® with the greatest of ease from the multifunction steering wheel: navigate through menus, control playback, adjust the volume and also display the selected track title in the instrument cluster. The iPod® is connected in the glove compartment meaning it can be kept out of sight. It is also charged at the same time



Stainless-steel side skirts. Made from V2A stainless steel and polished to a high gloss, these side skirts create a refined look that perfectly complements your light-alloy wheels. The set includes two tubes (L 2330 mm, Ø 60 mm) and brackets. Simply bolted into position. Suitable for compact and long versions of the Viano



Rear-mounted bicycle rack. Designed to be fitted to the tailgate. For holding two bicycles of virtually any type and size. The tailgate can still be opened with the rear-mounted bicycle rack attached. Includes statutory repeater lights which require a power supply at the rear of the vehicle. Please take this into account when ordering the vehicle

Paintwork

NON-METALLIC PAINTS



arctic white 9147



pebble grey 7701



flame red 3534



aqua green 6830



atlantis blue 5373



velvet red 3583

The Viano paintwork puts the finishing touch to the carefully crafted Mercedes-Benz corrosion protection system. The bodies are fully galvanised at the factory and treated with a cavity sealant for long-lasting protection.

METALLIC PAINTS



obsidian black metallic¹ 9197



brilliant silver metallic¹ 9744



sanidine beige metallic¹ 1798



amber red metallic¹ 3548



jasper blue metallic¹ 5345



cubanite silver metallic¹ 9723



flint grey metallic¹ 7368

¹ Metallic paintwork is available as special equipment

The seats in your Viano have a robust design and offer a particularly high standard of comfort. You put the finishing touch to them by selecting the fabric or leather upholstery of your choice.

FABRIC

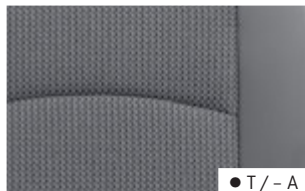

● T / - A

Leon, orion grey

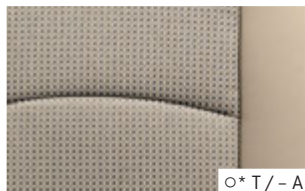

○* T / - A

Leon, stone

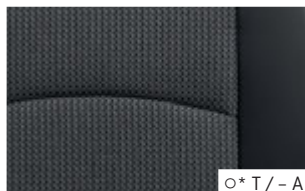

○* T / - A

Leon, anthracite

LEATHER

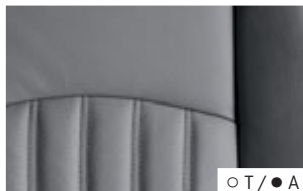

○ T / ● A

Lugano, orion grey



○ T / ○* A

Lugano, stone



○ T / ○* A

Lugano, anthracite

TRIM ELEMENTS



● T / - A

silverstone

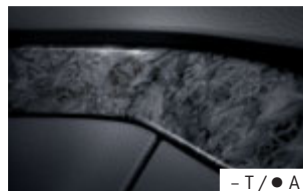

- T / ● A

black burr-walnut-look



- T / ● A

brown burr-walnut-look

- Standard
- Optionally available
- * Optionally available at no extra charge
- Not available
- T Viano TREND
- A Viano AMBIENTE

	FABRIC			LEATHER		
	Leon, orion grey	Leon, stone	Leon, anthracite	Lugano, orion grey	Lugano, stone	Lugano, anthracite
NON-METALLIC PAINTS						
arctic white 9147	■	□	■	■	□	■
aqua green 6830	■	■	■	■	■	■
atlantis blue 5373	■	-	■	■	-	■
velvet red 3583	■	■	■	■	■	■
pebble grey 7701	■	□	■	■	□	■
flame red 3534	■	□	■	■	□	■
METALLIC PAINTS						
obsidian black metallic 9197	■	■	■	■	■	■
brilliant silver metallic 9744	■	□	■	■	□	■
cubanite silver metallic 9723	■	□	■	■	□	■
jasper blue metallic 5345	■	□	■	■	□	■
amber red metallic 3548	■	■	■	■	■	■
flint grey metallic 7368	■	□	■	■	□	■
sanidine beige metallic 1798	■	□	■	■	□	■

■ Recommended □ Possible - Not recommended

Engine, fuel consumption and emissions data

Models	with rear-wheel drive				with 4MATIC all-wheel drive	
	CDI 2.0	CDI 2.2	CDI 3.0	3.5	CDI 2.0 4MATIC	CDI 2.2 4MATIC
No. of cylinders	4	4	6	6	4	4
Fuel type	Diesel			Premium petrol	Diesel	
Total displacement [cc]	2143	2143	2987	3498	2143	2143
Rated output [kW (hp)] at engine speed [rpm]	100 (136) 3800	120 (163) 3800	165 (224) 3800	190 (258) 5900	100 (136) 3800	120 (163) 3800
Max. torque [Nm] at engine speed [rpm]	310 1400–2600	360 1600–2400	440 1400–2800	340 2500–5000	310 1400–2600	360 1600–2400
Acceleration ¹ 0–100 km/h [s] (with manual/automatic transmission)	14.1/13.5	12.1/11.1	–/9.1	–/10.4	–/16.0	–/13.0
Top speed, approx. [km/h] (with manual/automatic transmission)	174/172	188/182	–/201	–/217	–/161	–/174
Tank capacity [l]	75	75	75	75	75	75

¹ Performance figures for a weight in accordance with DIN 70020-3 (corresponding to the EC kerb weight + payload of 200 kg)

² Figures according to Directive 92/21/EC in the version applicable at time of going to print (kerb weight incl. tools/spare wheel if supplied by manufacturer, fuel tank 90 % full, driver 68 kg and luggage 7 kg) for standard-specification vehicles. Special equipment and accessories will generally increase this figure and reduce the payload capacity accordingly.

Note: when measured in accordance with ISO-M06 1176, the kerb weights are reduced by up to 75 kg

³ Extra-long version or as special equipment in conjunction with additional seating or optional load uprating XA2

⁴ Depends on version (compact/long/extra-long) and/or permissible GVW

⁵ In conjunction with optional load uprating

⁶ Only in conjunction with automatic transmission

⁷ The figures shown were obtained in accordance with the prescribed measuring process [Regulation (EC) 715/2007 in the currently applicable version]. The figures are not based on an individual model and do not constitute part of the product offer; they are provided solely for purposes of comparison between different vehicle models

Models	with rear-wheel drive				with 4MATIC all-wheel drive	
	CDI 2.0	CDI 2.2	CDI 3.0	3.5	CDI 2.0 4MATIC	CDI 2.2 4MATIC
Kerb weight ² [kg] (compact/long/extra-long)						
TREND	2030/2055/2080	2030/2055/2080	2130/2155/2180	2050/2075/2100	2110/2135/2160	2110/2135/2160
AMBIENTE	2055/2080/2105	2055/2080/2105	2155/2180/2205	2075/2100/2125	2135/2160/2185	2135/2160/2185
Perm. gross vehicle weight [kg]	2800/3050 ³			2800/3050 ³	2800/3050 ³	
Payload capacity [kg]	720–1020 ⁴		620–920 ⁴	700–1000 ⁴	640–940 ⁴	
Towing capacity [kg]						
unbraked	750	750	750	750	750	750
braked	2000	2000	2000	2000	2000	2000
increased in conj. with special equip. (braked)	2500 ⁶	2500	2500	2500	2500 ⁵	2500
Tyre size	205/65 R 16	205/65 R 16	225/60 R 16	225/55 R 17	205/65 R 16	205/65 R 16
Max. roof load [kg]	150	150	150	150	150	150
Track circle Ø [m]	11.0/11.7	11.0/11.7	11.0/11.7	11.0/11.7	11.8/12.6	11.8/12.6
Turning circle Ø [m]	11.8/12.5	11.8/12.5	11.8/12.5	11.8/12.5	12.7/13.4	12.7/13.4
(compact and long/extra-long)						
Perm. gross combination weight [kg]	4770/4940 ³	4770/4940 ³	4770/4940 ³	4770/4940 ³	4770/4940 ³	4770/4940 ³
increased in conj. with special equipment	5100/5300 ³	5100/5300 ³	5100/5300 ³	5100/5300 ³	5100 ⁵ /5300 ^{3,5}	5100/5300 ³
CO ₂ emissions ⁷ , combined [g/km]	190–195/211–216	190–195/211–216	–/224–226	–/279–284	–/232–234	–/232–234
(with manual/automatic transmission)						
Fuel consumption ⁷ [l/100 km]						
(with man./autom. transmission)						
urban	8.8–9.0/10.0–10.2	8.8–9.0/10.0–10.2	–/10.8–10.9	–/16.3–16.5	–/11.1–11.2	–/11.1–11.2
extra-urban	6.4–6.6/6.8–7.0	6.4–6.6/6.8–7.0	–/7.1–7.2	–/9.3–9.5	–/7.4–7.5	–/7.4–7.5
combined	7.2–7.4/8.0–8.2	7.2–7.4/8.0–8.2	–/8.5–8.6	–/11.9–12.1	–/8.8–8.9	–/8.8–8.9

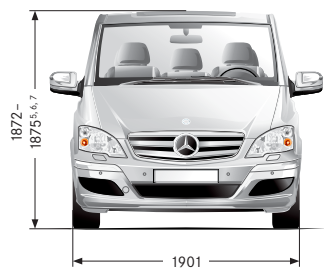

(2013 with exterior mirrors folded in)

¹ Dimensions can be increased by moving/removing seats

² Measured along the vehicle floor

³ Clear width ignoring wheel arches

⁴ Clear width between wheel arches

⁵ Vehicle height varies depending on vehicle length

⁶ Vehicle height with optional roof rails fitted increases by 48 mm

⁷ Vehicle height in conjunction with optional 4MATIC all-wheel-drive version:
1939 - 1942 mm

All illustrations are approximate. The dimensions shown are mean values (in mm) and apply to standard-specification, unladen vehicles

Compact version

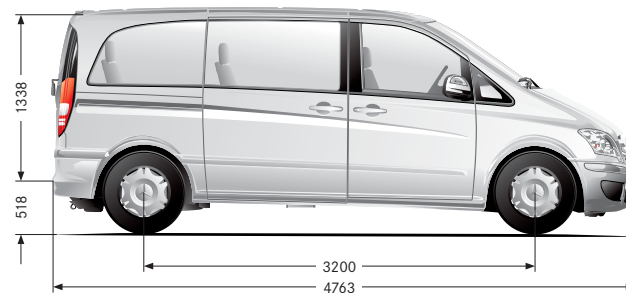

Long version

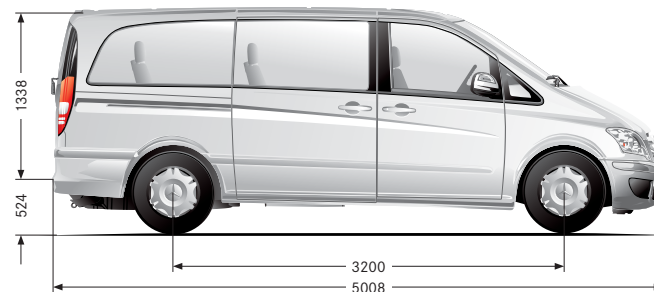

Extra-long version

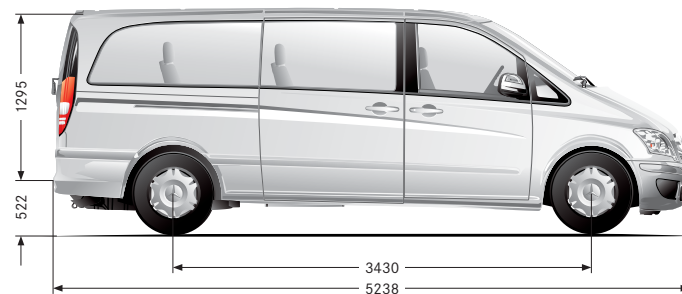

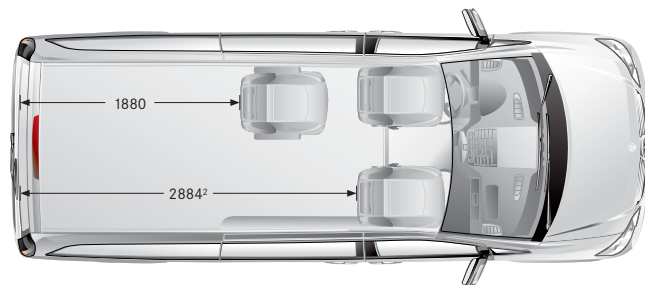
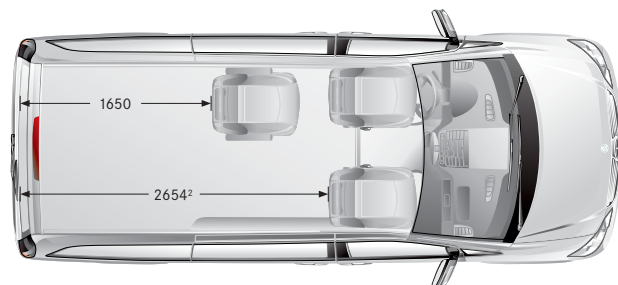
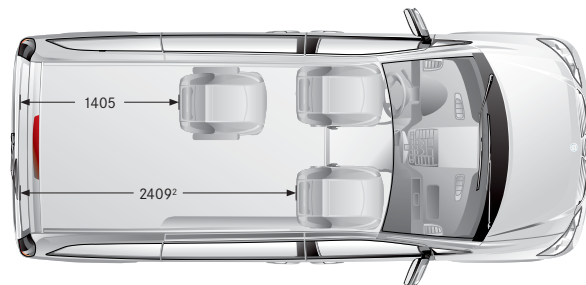
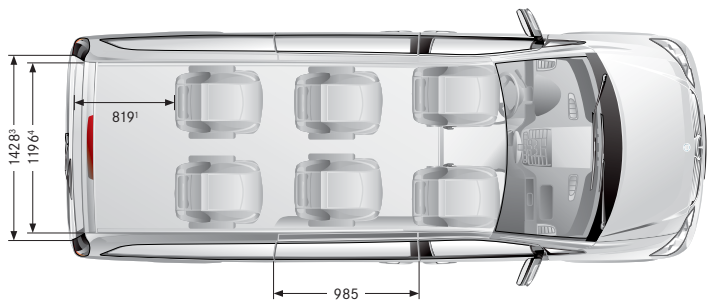
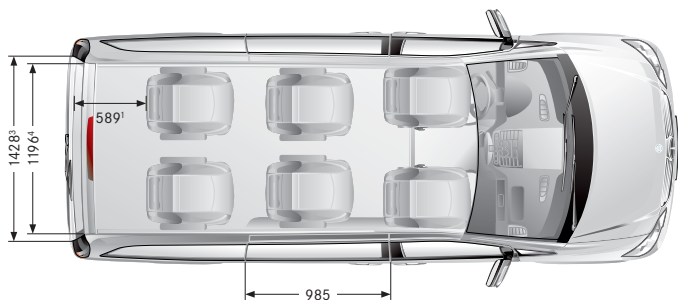
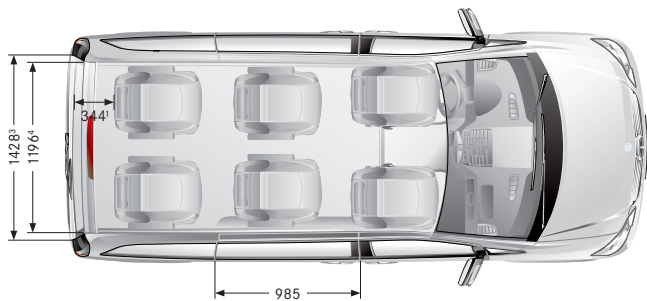

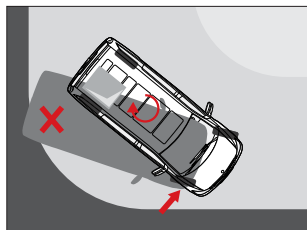

ADAPTIVE ESP® Electronic Stability Program

ADAPTIVE ESP® is an innovative dynamic handling control system, which for the first time also takes the vehicle load into account. It actively intervenes in certain hazardous driving situations, e.g. if there is an imminent risk of skidding, by applying a braking force to one or more wheels and adjusting the engine output as required so as to help the driver deal with the hazardous situation. As well as aiding directional stability, ADAPTIVE ESP® combines the functions of the anti-

lock braking system (ABS), acceleration skid control (ASR), electronic brake force distribution (EBD), Brake Assist (BAS) and the optional Start-off Assist system. The ESP® Trailer Stability Assist furthermore enhances driving safety when towing a trailer.

Note:

ADAPTIVE ESP® can only act within the limits of the laws of physics. As a result, it cannot prevent skidding caused by aquaplaning, for example. If the driver exceeds these limits, even ADAPTIVE ESP® will not be able to prevent an accident.

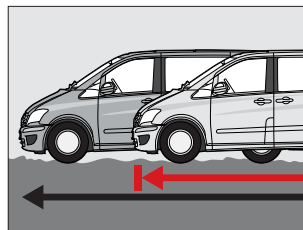

Brake Assist (BAS)

In tests carried out in the driving simulator, our research engineers established that drivers do not apply the brakes vigorously enough during emergency braking. This finding led them to develop the Brake Assist system. From the speed at which the brake pedal is depressed, Brake Assist is able to detect a situation which calls for emergency braking. In such cases, the system automatically increases the brake pressure, aided by the anti-lock braking system (ABS) which prevents the wheels from locking.

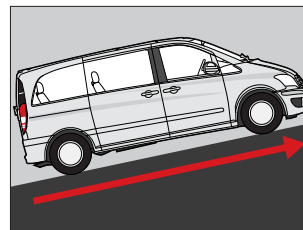

Start-off Assist

Start-off Assist, which is integrated into the ESP® system and comes as standard on automatic models, allows hill starts to be performed with ease: after the brake pedal is released, the brake pressure is maintained for approximately two seconds, allowing the driver to move their foot from the brake pedal to the accelerator without having to worry about the vehicle starting to roll. Start-off Assist is activated on uphill slopes of approx. 4 % or steeper. It is not activated when starting off on the flat or on a downhill slope.

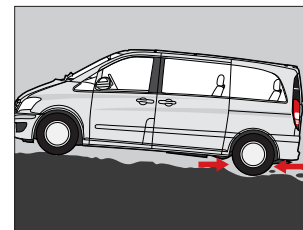

Acceleration skid control (ASR)

At the first signs of wheel slip, that is to say if the rotational speed of one of the driven wheels suddenly increases, ASR reduces the engine power and also intervenes in the brake system to prevent prolonged wheel spin. ASR ensures smooth start-off and acceleration, without prolonged wheel spin or sideways drift. The result is improved traction – and safety – particularly on split-friction or slippery surfaces.

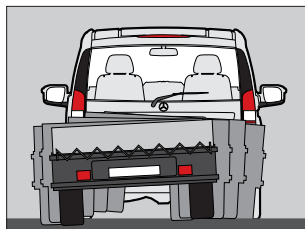

ESP® Trailer Stability Assist

This system complements ADAPTIVE ESP® and improves driving safety when towing a trailer by strategically applying the wheel brakes on the towing vehicle and reducing the engine torque if the trailer starts to sway from side to side, thereby helping the driver to stabilise the vehicle/trailer combination. Where the system intervenes several times in succession, the braking force is increased each time, resulting in a noticeable drop in road speed.

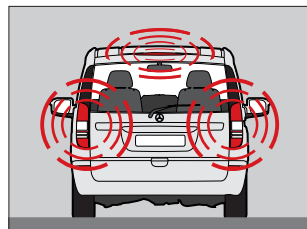

Adaptive brake lights

The adaptive brake lights enhance active safety as they give a clearer signal when the vehicle is braked in an emergency. This is achieved by all the brake lights starting to flash in the event of emergency braking at speeds above 50 km/h, thus warning following traffic and shortening the reaction times of the drivers behind. If the vehicle is braked to a standstill from a speed of over 70 km/h, the hazard warning lights are activated automatically.

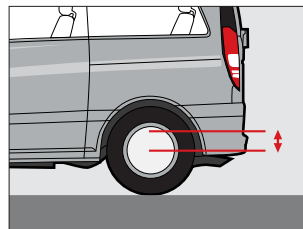

Air suspension with self-levelling function

Thanks to its electronic self-levelling function, the rear air suspension ensures safe roadholding under all load conditions while also providing a high level of passenger comfort and protection for sensitive cargo. The electronic level control keeps the vehicle at the same ride height whatever the load carried – a factor which also has advantages in the hours of darkness, as the road is always illuminated effectively without dazzling other traffic. The vehicle can be manually raised and lowered at the touch of a button to facilitate loading and unloading.

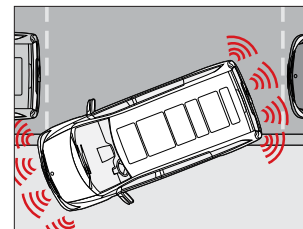

PARKTRONIC

PARKTRONIC is a parking aid which assists the driver when parking or manoeuvring in confined spaces. Working on the same principle as sonar, the system automatically warns the driver of obstacles just in front of or behind the vehicle. The warning is provided initially in the form of a visual display in the centre of the instrument panel. When the distance to an obstacle falls below 35 cm, the audible warning is also activated, first intermittently and then as a continuous tone at a distance of about 20 cm.

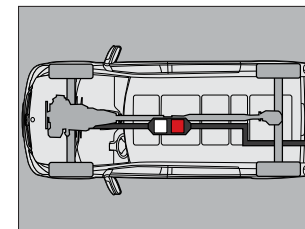

Diesel particulate filter

Particulate emissions per diesel car have been drastically lowered in recent years. Nonetheless, the constantly increasing number of diesel vehicles means that total emissions are too high and need to be reduced further. The diesel particulate filter from Mercedes-Benz is a breath of fresh air in this respect. It removes more than 95 % of the particulates from the exhaust gases. At the same time a continuous regeneration process prevents the filter from becoming clogged – which means that no fuel additives are needed.

Anyone opting for a Mercedes buys far more than just a car

To ensure your sustainable mobility we think beyond the vehicle itself. From a repair service and mobility packages right up to individual financing and leasing schemes, we offer a multitude of services designed to keep you and your Viano on the road.

You can experience the legendary Mercedes-Benz brand and service in our close-knit network of company-owned sales and service outlets or at your local dealership. Here you are assured the wide range of services, the comprehensive customer care and the high quality which you have come to expect of Mercedes-Benz.





Service and parts

Extended opening hours

Mercedes-Benz Service24h

Mercedes-Benz ExpressService

Mercedes-Benz MobilityGo

Mercedes-Benz GenuineParts

Mercedes-Benz Genuine Remanufactured Parts

Financing and leasing

Standard financing

Balloon payment financing

Option financing

Leasing

Finance leasing

Balloon payment leasing

Insurance

Vehicle insurance

GAP insurance

Payment protection

Extension of warranty

Comprehensive service from Mercedes-Benz

Extended opening hours. Mercedes-Benz service outlets are open from Monday to Friday until 8 p.m., 10 p.m. or, in some cases, around the clock. This means that you can have major maintenance or repair work taken care of when your vehicle isn't normally being used.

Mercedes-Benz Service24h. You can always count on us: should your Mercedes ever have starting problems or break down en route, our freephone¹ Service24h hotline (on 00800 3 777 7777) will arrange expert assistance for you as quickly as possible. The hotline can be reached from anywhere in Europe. Our service personnel are on hand 24 hours a day, 365 days a year to ensure that you are back on your way again without delay.

Mercedes-Benz ExpressService. As vehicle availability is paramount we offer you the Mercedes-Benz ExpressService. Oil changes can be carried out, minor maintenance and repairs performed on wear parts and small parts replaced without having to make an appointment and at a fixed price. Meaning that all the work necessary for quickly resuming your journey can usually be completed within the space of 2 hours.

Mercedes-Benz MobilityGo. Mercedes-Benz MobilityGo gives you free on-the-spot breakdown or starting assistance should your vehicle ever break down or fail to start; the free MobilityGo service package also includes payment of taxi fares and the provision of a replacement vehicle. We will also keep you mobile and pay your costs if your vehicle has to go into the workshop under

warranty and the repairs are likely to take more than two hours. Your Mercedes-Benz dealer would be happy to provide you with further details about MobilityGo conditions and coverage – just call in and ask!

Mercedes-Benz GenuineParts. Mercedes-Benz genuine parts undergo rigorous material and functional testing, are engineered to fit your vehicle perfectly and continue to be available for 15 years after the end of series production.

Mercedes-Benz Genuine Remanufactured Parts. If your vehicle has been on the road for some time, Mercedes-Benz genuine remanufactured parts are an ideal choice. Reconditioned in accordance with the current state of the art, they are subjected to the same function checks as

new parts and offer the same high standard of guaranteed quality as our Mercedes-Benz genuine parts. There's one key difference: they cost up to 50 % less!

MercedesCard. It acts as your ticket to the world of Mercedes-Benz and doubles as a practical credit card – with no fee if you complete our annual questionnaire. The MercedesCard Journal regularly features details of exclusive sporting, travel and cultural events, as well as news of exciting products. There's also the Mercedesmagazine containing fascinating articles about the Mercedes-Benz brand. And your MercedesCard gives you free entry when you visit the Mercedes-Benz Museum. Please consult your national Mercedes-Benz website for further details.

Mercedes-Benz Financial Services. If you already have your heart set on a particular Viano model and wish to remain financially independent, you may be interested in our range of financial services. With the standard financing package, you can pay for the model of your choice in convenient fixed monthly instalments, for example. This allows you to enjoy financial flexibility and instant mobility. Or maybe you would like to drive a Viano equipped to your own specification but only pay for the use of it? Then our leasing option is just what you're looking for. Leasing doesn't tie up any capital and does not affect your credit potential in any way, while the fixed rates make it easy to keep a track of your finances. We are your one-stop shop for leasing, financing, insurance and service packages, all offered at

attractive conditions. Further information about the financing and leasing products available from Mercedes-Benz Financial Services can be found online by visiting www.mercedes-benz-bank.de

¹ This hotline number can be called free of charge from landline phones and mobile phones. In some European countries, calls from mobile phones are subject to a charge set by the network operator. If your network operator does not permit international or freephone calls, we recommend that you use the relevant supplementary number for the country concerned as an alternative. This can be found on the Service24h sticker in your vehicle





Time for another enriching experience

Test drive the vehicle of your dreams

A Mercedes is most at home on the road. This is the only way to experience the effortlessly superior driving feel that makes every model so special. Discover how the new Viano can enrich your everyday life with its adaptability and high standard of comfort. The unique feeling of driving it cannot be gleaned from a brochure. Which is why we'd like to invite you to take a test drive. Your Mercedes-Benz dealer will be happy to make all the necessary arrangements for you. Simply visit www.mercedes-benz.com to locate your nearest Mercedes-Benz dealer. We're looking forward to seeing you!

Take-back of end-of-life vehicles. Coming full circle. At the end of its long working life, you can return your Viano to us for environment-friendly disposal in accordance with the EC End-Of-Life Vehicle Directive. But that day lies a long way off. The take-back of end-of-life vehicles applies in accordance with national regulations to vehicles up to 3.5 tonnes gross weight. The Viano has met the statutory requirements governing the suitability of the vehicle's design for reuse and recycling for a number of years now. A network of vehicle take-back depots and dismantlers has been established which will process your vehicle in an environment-friendly manner. The ways in which both vehicles and parts can be recovered are subject to ongoing development and improvement. Consequently, the Viano will be able to comply with any future increases in the recycling quota within the stipulated time limits. Further information is available from www.mercedes-benz.com or your national hotline.

Please note: changes may have been made to the product since this brochure went to press (31.01.2010). The manufacturer reserves the right to make changes to the design, form, colour and specification during the delivery period, provided these changes, while taking into account the interests of the vendor, can be deemed reasonable with respect to the purchaser. Where the vendor or the manufacturer uses symbols or numbers to describe an order or the subject of an order, no rights may be derived solely from these. The illustrations and descriptions may include accessories and items of special equipment which are not part of standard specification. Colours may differ slightly from those shown in the brochure, owing to the limitations of the printing process. This brochure may contain models and services which are not available in certain countries.

This brochure is distributed internationally. Information given regarding statutory regulations, legal requirements and taxation and the consequences thereof applies to the Federal Republic of Germany only and is correct at the time of going to press. Please consult your Mercedes-Benz van dealer for final details.

www.mercedes-benz.com