

This Brochure is prepared by Daimler AG and it predominantly reflects the capabilities and performance of vehicles sold in Europe. Some characteristics, capabilities, performance features and optional extras (e.g. towing systems) may not be available or may not apply in Australia or under Australian conditions. The information in this Brochure is therefore indicative, illustrative and provided only for guidance and should not be relied on. To obtain current and accurate information on a vehicle and any options applicable to Australia, contact your local authorised Mercedes-Benz dealer.



Mercedes-Benz

# The CL-Class



Mercedes-Benz





technologies to make an unforgettable impression. Meet a car that is your equal  
journey by a system that dutifully distributes the drive torque to all four wheels  
ete trust. Creating a truly moving experience requires unwavering commitment  
amental technologies. With impressive results: CO<sub>2</sub> emissions in the CL 500  
that is achievable rather than extravagance. If the CL had a favourite tense, it  
crucial seconds ahead thanks to its sophisticated driving assistance systems  
e as options, can thus help to prevent hazardous situations. It slips through  
and even more harmonious feel about it than its predecessor model. The radi  
forward, the tail end seems wider. It's hard to believe your eyes as you glance  
ve appearance: **Excellence in a brand new form.** Sheer passion tamed by el  
us materials seduce the senses. And its dynamism is infectious. One look is



Not only is the CL a paragon of elegance and luxury, it's a masterpiece of engineering too. The generation of V8 engines with BlueDIRECT technology sets new standards of efficiency and performance. Meanwhile, an array of sensors and intelligent electronic systems help to make the CL even safer and more comfortable.

Its dynamic design takes your breath away with a magical allure that enchants anyone, no matter how high their expectations are. At the essence of the CL is the resolve to keep improving, even when perfection has been reached. And that is precisely what makes it so special: excellence in a brand new form.

At a glance | from page 4    Insight | from page 28

#### Featured models:

---

**CL 500 4MATIC BlueEFFICIENCY | palladium silver metallic**  
Cover and from page 2

Multi-spoke light-alloy wheels, Exclusive PASSION Leather package in aubergine/black, high-gloss light brown burr walnut wood trim

---

**CL 600 | cornetite blue metallic | from page 15**

5-twin-spoke AMG light-alloy wheels, Exclusive PASSION Leather package in sahara beige/black, high-gloss brown poplar wood trim

---

**CL 63 AMG | iridium silver metallic | from page 22**

Triple-spoke AMG light-alloy wheels, Exclusive PASSION Leather package in black, AMG carbon-fibre trim

The illustrations may show non-standard accessories and optional extras

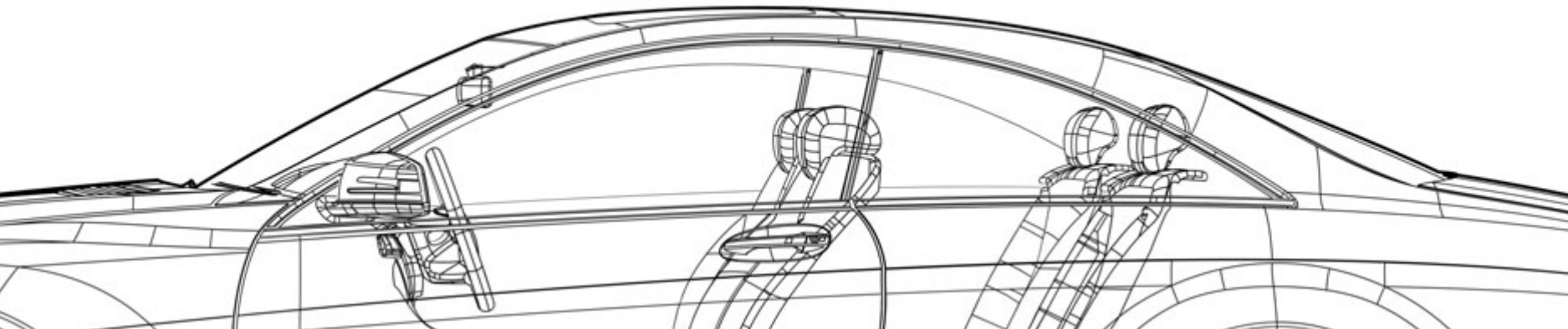

**Dynamism at its best:** engines, transmissions and chassis.

Drive system & chassis | from page 36

**High safety:** sophisticated solutions and proven technologies which can act in advance to help prevent accidents, mitigate their possible consequences and facilitate rescue.

Safety | from page 44

**Relaxation en route:** everything about the entertainment, multimedia and assistance systems, climate control and seating comfort.

Comfort | from page 48

**The right CL for any situation:** CL 500 BlueEFFICIENCY, CL 500 4MATIC BlueEFFICIENCY and CL 600.

Model variants | from page 54

**Mighty AMG coupés:** the CL 63 AMG and CL 65 AMG models.

AMG | from page 58

**A coupé with personality:** standard equipment and optional extras, design, upholstery and trim, light-alloy wheels and genuine accessories.

Equipment & appointments | from page 64

**Star-studded service:** everything about the Mercedes-Benz Museum and services.

Services | from page 80

**CL in detail:** dimensions, paintwork and technical data.

Facts & colours | from page 82







**Making prowess a way of life:**

We have a long tradition of building outstanding coupés – and the CL is yet another extra-special one. It is the coupé in which the boldest visions of our engineers and designers are brought together in spectacular fashion. It is the coupé which perpetuates the evolution of the motor car so effortlessly. And it is the coupé you'll have already seen so many times in your dreams.

**Masterfulness**

A top-class means of travel for  
top-class achievers:

Style, skill and sophistication: the CL blends vivid design,  
true craftsmanship and sophisticated technologies to  
make an unforgettable impression. Meet a car that is  
your equal – and every bit as discerning.

Effortless superiority







**Eliminating the element  
of surprise:**

With the optional 4MATIC permanent all-wheel drive, you will be accompanied on every journey by a system that dutifully distributes the drive torque to all four wheels and makes your car feel more like your travel companion. The result is even greater traction and handling safety, no matter whether you are driving over asphalt or sand, in the wet, through snow or on black ice. Yet another detail of a car that is truly deserving of your complete trust.

**Predictability**











### A marriage of courage and respect:

Creating a truly moving experience requires unwavering commitment. That is why the CL incorporates only the very finest of traits: consistent style, absolute dedication and advanced environmental technologies. With impressive results: CO<sub>2</sub> emissions in the CL 500 BlueEFFICIENCY have been cut by up to 22% compared with the predecessor model. Luxury that reflects the pinnacle of what is achievable rather than extravagance.

### Responsibility

















**A staggering feat of  
innovation:**

If the CL had a favourite tense, it would be the future tense. Because instead of concentrating on the here and now, it thinks a few possibly crucial seconds ahead thanks to its sophisticated driving assistance systems. Advanced solutions such as Active Lane Keeping Assist and Active Blind Spot Assist, both of which are available as options, can thus help to prevent hazardous situations.

**The power of invention**







When two eyes are  
not enough:

It slips through the wind but cannot escape the wondrous gaze of all around: the CL has a more mature, more dynamic and even more harmonious feel about it than its predecessor model. The radiator grille's two striking louvres set the tone, the bonnet's four bold lines make it appear to be straining forward, the tail end seems wider. It's hard to believe your eyes as you glance from one new thrilling detail to another.

Harmony















A close-up, low-angle shot of the interior of a luxury car. The focus is on the driver's side, showing the leather-upholstered seat, the center console, and the door panel. The car's interior is dark, with subtle highlights on the leather and the air vents. Through the window, a cityscape at night is visible, with lights reflecting on the water. The overall mood is sophisticated and elegant.

A breathtaking sense of speed,  
even at standstill:

The character of the CL lives up to all the promise of its distinctive appearance: sheer passion tamed by elegance. Flowing lines exude power, while luxurious materials seduce the senses. And its dynamism is infectious. One look is all it takes.

**Spirit**





### Good advice at the right time:

You always have its undivided attention: the CL can see to it that critical situations don't arise in the first place. ATTENTION ASSIST follows your reactions at the wheel and can suggest taking a break from driving as soon as it detects signs of drowsiness. So the system can help you to take time out at the appropriate moment.

### Attentiveness







## The manual revolution

27 bones, 33 muscles, 3 nerves, 17,000 nerve endings and a unique sensitivity to the world around it – the human hand is the most reliable tool we know. Making it the only one that is good enough to build the CL.

90% of the steps involved in the assembly of the CL are carried out just by hand without the use of machines, with some even requiring the very finest craftsmanship. There are just two robotic stations for installing the windscreen, rear window and the cockpit. A hand-picked team of mechanics work with the utmost precision to make sure that every component and piece of trim fits perfectly and every last stitch is flawless. In the process, our employees always add a very special ingredient that no machine could ever emulate: the pride they take in yet another masterpiece from Mercedes-Benz.

### **Our very first assistance system**

In the early days of motoring, cars were often regarded as mechanical monsters that were full of mysterious technology and difficult to control. Steering them required a great deal of physical effort, while their day-to-day operation called for highly specialist knowledge. This prompted the Daimler-Motoren-Gesellschaft to occasionally supply its cars complete with true experts. Not only did they deliver the cars, they also showed the affluent clientele how to operate these technological marvels. They also assumed the combined role of mechanic, chauffeur and travel companion – sometimes for weeks or even months.

One such expert was Rudolf Schwarz, who was born in Ludwigsburg in 1878. Cool-headed, highly reliable and an employee who was held in great esteem by Gottlieb Daimler himself, he was in effect one of the very first assistance systems for making motoring safe. Today, the CL comes equipped with more than a dozen various assistance systems which can all help to ensure that you enjoy a safe journey.









systems. Upholstery and trim. In an accident. Metallic paints. Sound system  
as. Fuel consumption. Interior. In the event of danger. LED daytime running  
Multimedia systems. Drive system. Genuine accessories. Airbags. Equipme  
emissions. Upholstery and trim. Safety. Technical data. Comfort. Safe drivin  
Acceleration. Design. Emission class. Safe driving. Light-alloy wheels. Top  
s. Paintwork. Total displacement. Facts and colours. Climate control. Seats.  
t drive. Equipment & appointments. CO<sub>2</sub> emissions. Memory package. Tran  
nders. Technical data. Interior. Services. Safety. Assistance systems. Uphols  
ass. Safe driving. Light-alloy wheels. Top speed. Optional extras. Chassis &  
Engines. AMG. **The facts.** Paintwork. Total displacement. Climate control. S  
mory package. Transmission. Surround sound system. Wheels. Interior. Sa

34	Drive system & chassis	Safety	Comfort	Model variants
36	<b>BlueEFFICIENCY</b>	44 <b>Safe driving</b> ATTENTION ASSIST	48 <b>Multimedia systems</b> COMAND APS	54 <b>CL 500 BlueEFFICIENCY</b>
37	<b>CL-Class with BlueDIRECT technology</b>	Adaptive Highbeam Assist Night View Assist Plus Driving Assistance package Plus	SPLITVIEW Harman Kardon® Logic 7® surround sound system	55 <b>CL 500 4MATIC BlueEFFICIENCY</b>
38	<b>Petrol engines</b> 8-cylinder 12-cylinder	46 <b>In the event of danger</b> PRE-SAFE® Brake and BAS PLUS PRE-SAFE® system	50 <b>Assistance systems</b> Reversing camera PARKTRONIC including Parking Guidance Speed Limit Assist	56 <b>CL 600</b>
40	<b>Transmissions</b> 7G-TRONIC PLUS 5-speed automatic transmission	47 <b>In an accident</b> Airbags	52 <b>Climate control</b>	
42	<b>Chassis &amp; suspension</b> Active Body Control ABC including crosswind stabilisation AIRMATIC 4MATIC		53 <b>Seats</b> Active multicontour seats Climatised front seats	

## The CL-Class in detail



58 **CL 63 AMG**60 **CL 63 AMG technology**

AMG 5.5-litre V8 engine

AMG SPEEDSHIFT MCT

7-speed sports transmission

62 **CL 65 AMG**64 **Standard equipment**65 **Optional extras**66 **AMG Sports package**68 **designo**70 **Upholstery and trim**76 **Wheels**78 **Genuine accessories**80 **Services**

MercedesCard

Mercedes-Benz Financial Services

Mercedes-Benz mobility

Mercedes-Benz Museum

Test drive

Interactive Owner's Manual

Mobile internet

Service packages

Repair following an accident

82 **Dimensions**82 | 85 **Paintwork**83 **Technical data**

## BlueEFFICIENCY – fast forward to tomorrow



Mercedes-Benz is quicker at getting future technologies to where it matters most: on the road. By the end of 2012, you will have more than 140 Mercedes-Benz models with BlueEFFICIENCY technologies at your disposal, all of which help you reduce your impact on the environment. Our BlueEFFICIENCY concept comprises innovations for efficient mobility as well as optimised processes all the way along the value chain.

**The BlueEFFICIENCY measures – the Mercedes-Benz efficiency package.** This package consists of comprehensive vehicle optimisations which ease the burden on the environment. Each model combines the most efficient engine with intelligent, latest-generation aerodynamic and energy-management measures. Such measures include the ECO start/stop function, which is being made available for an increasing number of models. The BlueDIRECT V6 and V8 petrol engines, which feature in several model series, deliver a much higher power output while reducing fuel consumption by up to 25%.

**BlueTEC – the clean diesel.** A modular emission-control system makes BlueTEC an exceptionally clean diesel technology. As well as removing 95% of the particulate, it also reduces nitrogen oxides by up to 90%. What remains is mainly water and nitrogen.

**HYBRID – petrol and electric drives intelligently combined.** Here the electric motor can be used both for accelerating and for recuperating braking energy, which is stored in the battery. What's more, the ECU shuts off the petrol engine when the speed is below 15 km/h. In this way, a HYBRID implements significant fuel savings.

**BlueTEC HYBRID – clean diesel combined with electric drive.** It marries the benefits of the HYBRID with those of BlueTEC: during braking, the kinetic energy is converted into electrical energy, which can be re-used when required. At the same time, the BlueTEC technology cleans the exhaust gases and removes many of the pollutants. All of which makes the

economical diesel powerplant even more efficient and clean.

**Innovative drive systems that break new ground: E-CELL and F-CELL.** We have developed two locally emission-free drive systems which have been produced on a small scale since 2010. The B-Class F-CELL<sup>1</sup> uses hydrogen to produce power for the electric motor, while the A-Class E-CELL<sup>1</sup> draws its energy directly from two lithium-ion batteries.

But that is not all: under the banner “Design for Environment”, we also look at a vehicle's entire lifecycle and work hard to preserve the environment from the planning stage right through to recycling. In addition, we are involved in the development of alternative fuels and carry out research in the field of bionics. Further information about our comprehensive measures can be found at [www.mercedes-benz.com/blueefficiency](http://www.mercedes-benz.com/blueefficiency)

<sup>1</sup> Provisional data: efficiency class: A++

The data are not based on an individual model and do not constitute part of the product offer; they are provided solely for purposes of comparison between different vehicle models

## CL-Class with BlueDIRECT technology

The CL-Class has always been a car whose technology sets new standards. Consequently, it also leads the way when it comes to measures aimed at reducing fuel consumption and emissions. It also boasts an impressive drag coefficient ( $c_d$  figure)

When we develop a new model, responsibility for the environment plays a crucial role. People's awareness is increasing as emissions, fuel

consumption and fuel prices become topics that affect us all. It is therefore only natural that there are also CL-Class BlueEFFICIENCY models.

And, far from being just a vision of a clean environment, BlueEFFICIENCY incorporates a whole raft of specific measures:



- 1 ECO start/stop function in the CL 500 BlueEFFICIENCY/ CL 500 4MATIC BlueEFFICIENCY and CL 63 AMG
- 2 BlueDIRECT generation of V8 engines incorporates measures such as downsizing, direct petrol injection, two compact turbochargers for spontaneous response and intercooling for optimised thermodynamic efficiency
- 3 Sealed joints around the headlamps for improved aerodynamics
- 4 Optimised 7G-TRONIC PLUS for V8 engines
- 5 Euro 5 certification for entire engine range
- 6 Alternator management with braking energy recuperation (V8 engines)
- 7 Aerodynamically styled exterior mirror housings
- 8 Energy-saving control of auxiliary units for V8 engines (power steering pump as well as oil and water pumps)
- 9 Specially designed tyres for lower rolling resistance



## Petrol engines

The BlueDIRECT petrol engines for the CL combine more intense driving pleasure with reduced environmental pollution more effectively than ever. Consequently, the advanced V8 engine in the CL 500 BlueEFFICIENCY sets standards for efficiency and performance with its direct fuel injection and twin turbochargers

**V8 engine.** The drive unit from the new BlueDIRECT family of Mercedes-Benz engines has been specially developed and is making its debut in the CL 500 BlueEFFICIENCY. On the one hand, it excels with a fuel consumption that is 22% lower than on the predecessor model – with a reduction in emissions. This is the result of lightweight design measures throughout, a moderate degree of downsizing to a displacement of 4.7 litres, direct injection with ultra-precise piezoelectric injectors, plus forward-looking BlueEFFICIENCY technologies. The ECO start/stop function, for instance, is designed to temporarily shut off the engine when stopped at lights or in traffic. On the other hand, its performance credentials have been given a boost by the twin turbochargers and intercooling. A power output

that has been upped to 320 kW, a substantially higher torque of 700 Nm on tap from just 1800 rpm, plus improved acceleration – compared with the predecessor model in both cases – promise effortlessly superior motoring in any situation. And the V8 engine proves supreme when it comes to emissions efficiency too: it meets the Euro 5 standard.

**V12 engine.** It's the crème de la crème of all Mercedes-Benz engines – with silky smooth running, spontaneous power and a superlative sound. At the same time it is also efficient, sophisticated and, by complying with the Euro 5 emissions standard, state of the art. The V12 twin-turbocharged engine's peak torque of 830 Nm is on tap even before the 2000 rpm mark has been

reached. The CL 600 powers from 0 to 100 km/h in just 4.6 seconds, with the V12 generating 380 kW with the help of its twin turbochargers and intercooling.

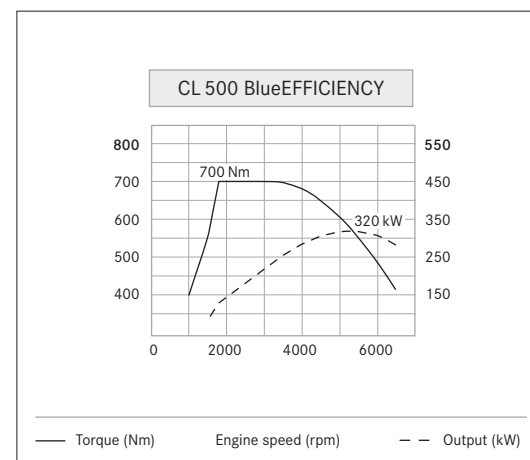

The CL 500 BlueEFFICIENCY: sophisticated engine technology with piezoelectric direct injection

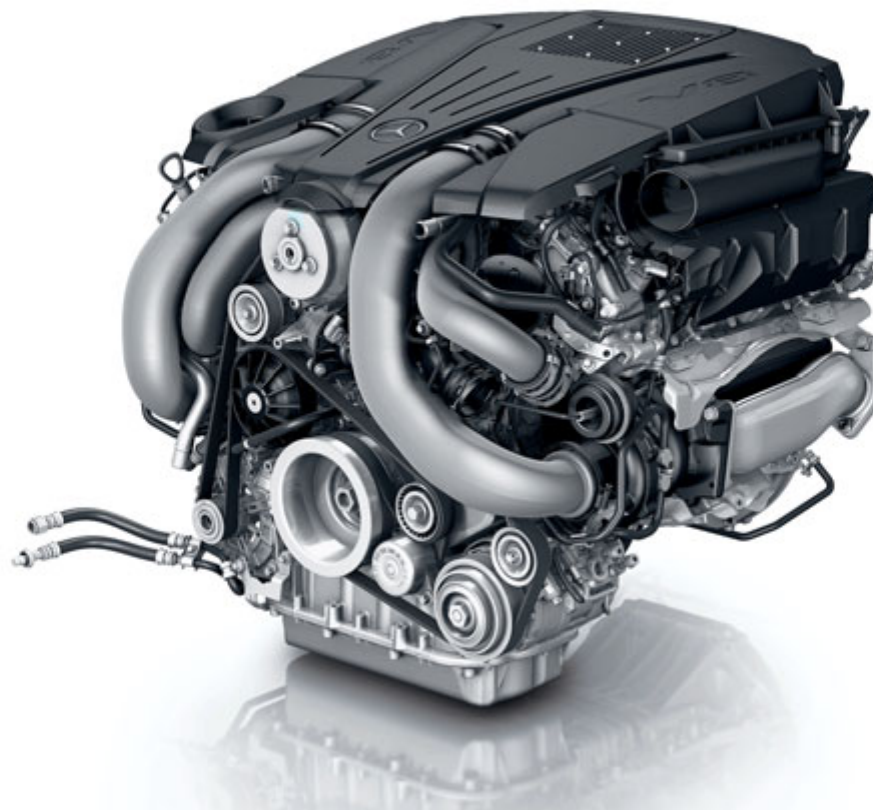

The V8 powerplants are the first derivatives of the new BlueDIRECT family of engines from Mercedes-Benz

# Transmissions

Whatever your driving style – economical or sporty – the transmissions for the CL have been optimised with your needs firmly in mind

**7G-TRONIC PLUS.** The V8 engines are paired with the newly refined Mercedes-Benz 7-speed automatic transmission as standard. The 7G-TRONIC PLUS is controlled using the DIRECT SELECT lever on the steering column. The seven forward gears maintain optimum revs, thus reducing both fuel consumption and noise levels. The minimal shift times and seamless transitions also make for excellent acoustic comfort as well as wonderfully smooth gearshifts. A set-up switch enables the driver to choose from three different shift modes: Manual, Comfort or Sport. Manual gearshifts

are performed using paddles on the steering wheel – just like in the world of motorsport.

**5-speed automatic transmission.** This transmission is perfectly suited to the 12-cylinder engine's characteristics – gear changes are so fast and smooth that they are barely perceptible, while just the right amount of power is delivered for every situation. Drivers can change gear manually here too if the optional steering-wheel gearshift paddles are ordered.



Fingertip transmission control with the DIRECT SELECT lever on the steering wheel



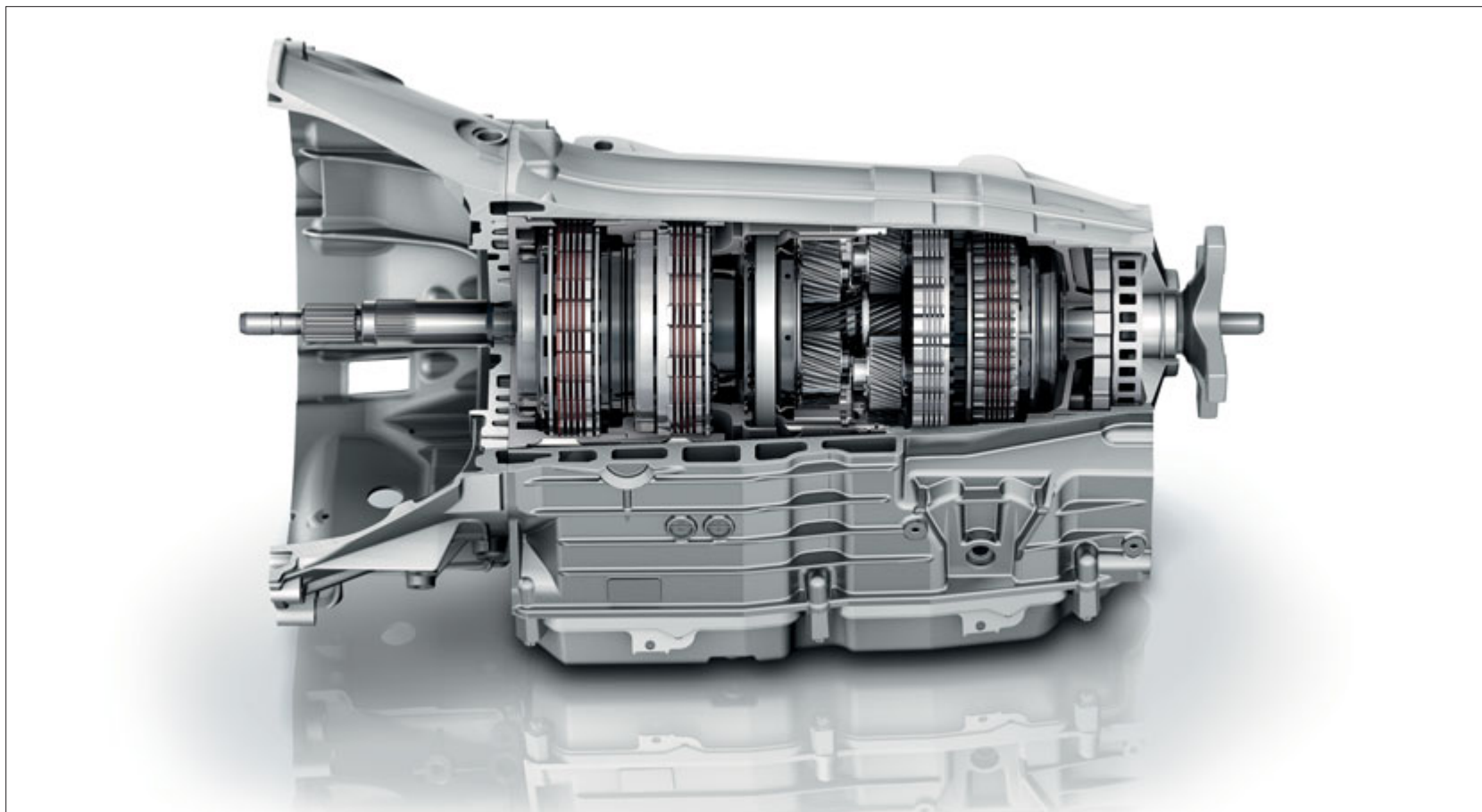

The 7G-TRONIC PLUS: one of over 18 million Mercedes-Benz automatic transmissions produced in a period spanning more than 50 years

## Chassis & suspension

Comfort is omnipresent – thanks to precision-tuned chassis and suspension components plus the option of powerful all-wheel drive

**Active Body Control ABC including crosswind stabilisation** (standard on all models except CL 500 4MATIC BlueEFFICIENCY). The active suspension system can provide both a comfortable and an agile ride as its set-up can be adapted as required in an instant. Microprocessor-controlled suspension struts compensate for the car body's lift, pitch and roll by selectively

raising or lowering the suspension to counteract these movements. The same process is employed to reduce body movements when the CL pulls away or brakes. By distributing the wheel load accordingly, the crosswind stabilisation can compensate for the effect of crosswinds, and helps to keep the vehicle on course, even in stormy weather.

**AIRMATIC** (standard, CL 500 4MATIC BlueEFFICIENCY only). The air suspension system with adaptive shock absorbers also adjusts itself to suit the current road conditions, vehicle load and driving situation exactly. The driver is also able to choose between a more comfort-oriented or a sporty setting manually.

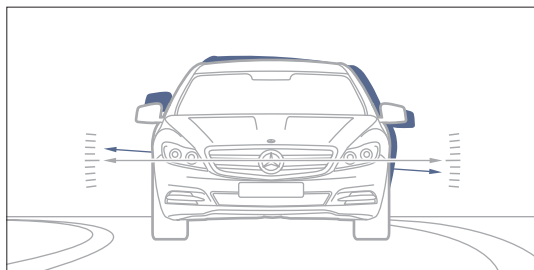

ABC ensures an extremely agile and dynamic driving feel

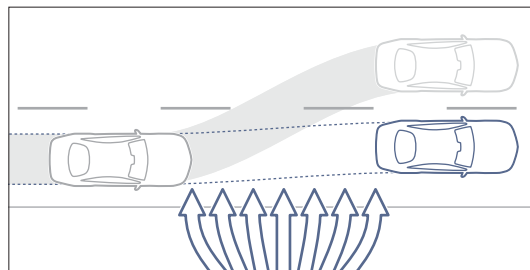

Crosswind stabilisation improves handling by actively influencing the wheel forces

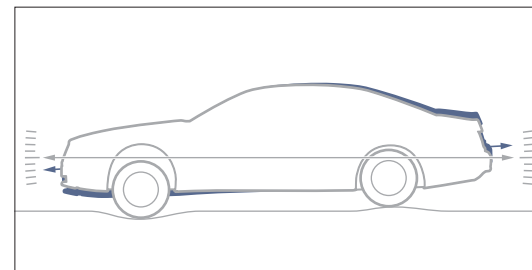

AIRMATIC air suspension enhances ride comfort, even when road conditions are poor

**4MATIC.** The permanent all-wheel drive system splits the engine power between the two axles at a fixed ratio of 45% to 55% – for 100% traction. To this end, 4MATIC utilises the Electronic Stability Program ESP® as well as the electronic traction system 4ETS. The latter enables controlled braking of spinning wheels at the same time as increasing the drive torque at the wheels with

good grip. This allows plenty of power to be planted on the road when moving off and when accelerating, especially on poor road surfaces. Automatic braking pulses make it easier to move off on slippery surfaces as well as enhancing stability during critical manoeuvres. A further advantage of the system is the fact that it is hardly any heavier than the rear-wheel drive

version on account of the compact design, the intelligent choice of materials and high level of efficiency. 4MATIC is only available in conjunction with the 7G-TRONIC PLUS automatic transmission, meaning that it is not an option for the 12-cylinder or AMG models.

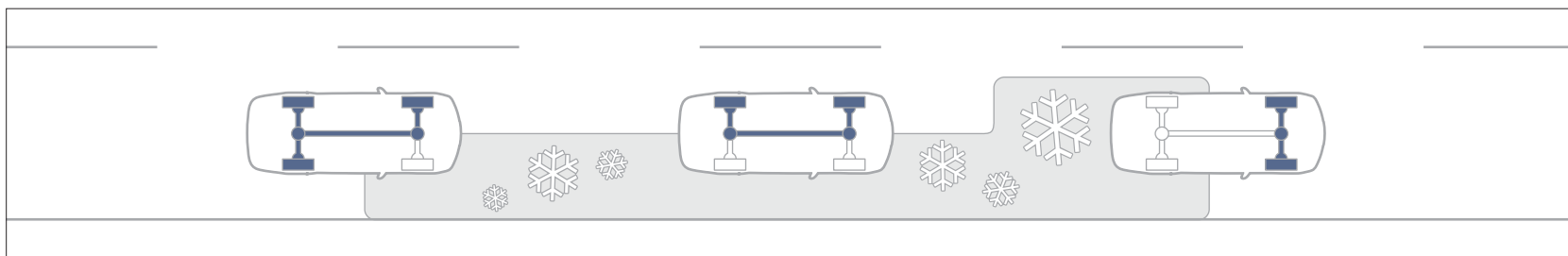

The electronic traction system 4ETS automatically directs the drive torque to the wheels with sufficient grip



## Safe driving

The assistance systems in the CL help to detect and defuse critical situations and, therefore, prevent accidents wherever possible

**ATTENTION ASSIST** (standard). This drowsiness detection system is useful on long trips. At speeds of between 80 and 180 km/h, ATTENTION ASSIST can alert the driver as soon as it detects lapses of attention. Several sensors are used to analyse driving behaviour on a permanent basis and detect telltale signs of drowsiness, such as involuntary steering movements.

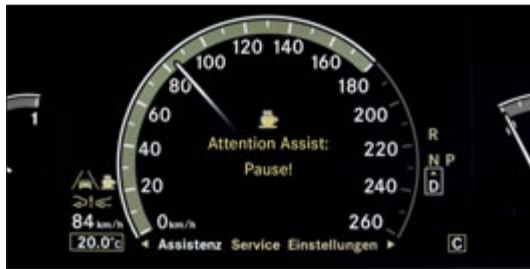

If ATTENTION ASSIST detects signs of drowsiness, it advises the driver to take a break

**Adaptive Highbeam Assist** (standard). Adaptive Highbeam Assist considerably improves your visibility in darkness without dazzling oncoming traffic or vehicles in front. By constantly optimising the headlamp range, it allows the driver to discern the line of the road, pedestrians or any danger spots earlier and more clearly.

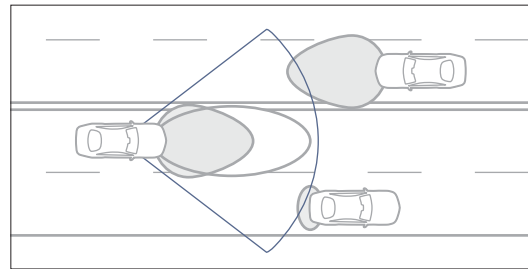

The low-beam headlamps have a range of up to 300 metres with Adaptive Highbeam Assist

**Night View Assist Plus** (option). Infrared headlamps illuminate the main-beam area in front of the vehicle. A special camera records the reflections and converts them into a greyscale image on the instrument cluster. Any people detected are briefly flashed at by a spotlight (deactivatable) and highlighted. This enables the driver to react more quickly to potential hazards.



Night View Assist Plus makes it easier to spot pedestrians ahead

**Driving Assistance package Plus** (option). This package's features include Active Lane Keeping Assist, which alerts the driver with a gentle vibration of the steering wheel if it detects the vehicle drifting out of the marked lane with a continuous line unintentionally. Should the driver fail to react, the vehicle's course can be corrected with a controlled application of the brakes. For safer lane changing, there is Active Blind

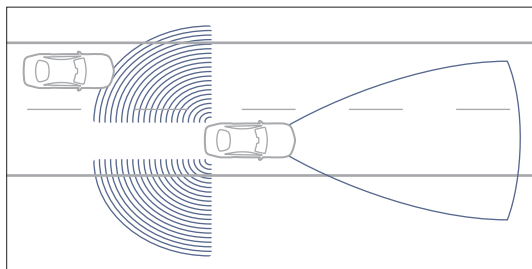

Active Lane Keeping Assist and Active Blind Spot Assist can warn the driver and intervene correctively if necessary

Spot Assist. When a vehicle is detected in the blind spot, a red warning triangle lights up in the exterior mirror. Should the driver indicate to change lane anyway, an acoustic warning will sound too. If the driver initiates a lane change irrespective of these warnings, the targeted application of the brakes can help to prevent a possible collision. DISTRONIC PLUS adaptive cruise control helps the driver to keep at the pre-



Active Blind Spot Assist increases safety when changing lanes

set distance from the vehicle in front. Finally, the PRE-SAFE® Brake is able to warn the driver of an impending rear-end collision and initiate partial and full brake applications if required. In this way, the severity of the impact can be reduced or it may even be possible to avoid a collision altogether.

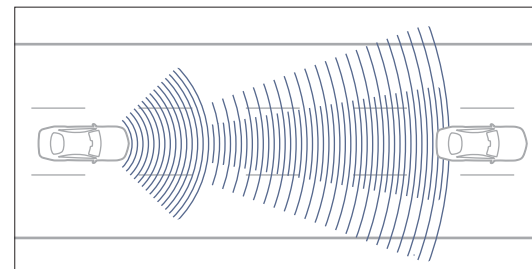

DISTRONIC PLUS adaptive cruise control helps the driver maintain the desired distance between the car and the vehicle in front

## In the event of danger

Anybody who travels on the road will have to face a dangerous situation sooner or later. That's why a range of systems has been developed for the CL-Class to help avoid possible accidents

**PRE-SAFE® Brake and BAS PLUS** (both part of the optional Driving Assistance package Plus). The PRE-SAFE® Brake first provides the driver with visual and audible warnings if the risk of a collision is detected. In this phase, BAS PLUS determines the brake pressure required to avoid a collision. If the braking force applied by the driver is insufficient, the system increases the braking pressure automatically so as to make optimum use of the remaining distance available whilst also giving the driver behind a better chance of avoiding a rear-end collision. If the Mercedes driver fails to respond, the system initiates autonomous partial braking 1.6 seconds before the calculated collision point, which decelerates the vehicle with around 40% of the maximum braking

power ( $4 \text{ m/s}^2$ ), thus giving the driver a further prompt to take action. If the driver also fails to respond to this haptic warning, the PRE-SAFE® Brake initiates autonomous emergency braking if required, meaning that an accident can be avoided or, at the very least, the severity of the collision can be reduced significantly.

**PRE-SAFE® system** (standard). The anticipatory occupant protection system, which Mercedes-Benz itself invented, is able to detect certain critical driving situations in advance and initiate precautionary measures. If a collision is deemed to be imminent, the system can close the front windows and sliding sunroof as well as moving the front passenger seat into a more favourable

crash position. If the active multicontour seats are fitted, the chambers in the side bolsters can be inflated to brace the front occupants laterally.

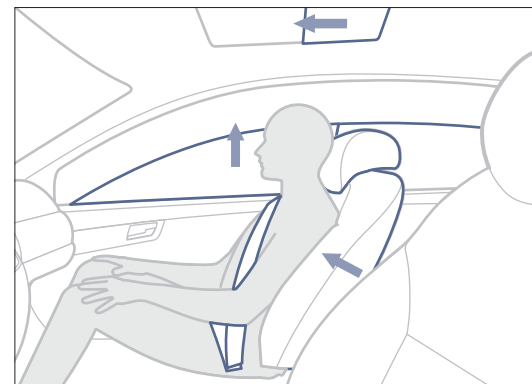

PRE-SAFE® helps to mitigate the consequences of accidents



## In an accident

The CL-Class provides a safer environment, even in the event of a collision. Multiple protective measures are activated to help protect occupants and significantly reduce accident severity

**Airbags** (standard). Airbags have been fitted as standard in all Mercedes-Benz passenger cars since October 1992. There are eight of them in the CL to help prevent injuries to all occupants in a collision. Front airbags with two-stage deployment come as standard, as do sidebags in the front seat backrests and two windowbags that extend over both the front and rear seats. Plus, there are rear sidebags fitted under the wheel-arch trim to increase protection for rear passengers in case of an impact. A lot of development work also went into the airbag control unit, which – along with the optional DISTRONIC PLUS short-range sensors – is capable of also factoring in critical approaches prior to a collision.



A total of eight airbags can protect you and other vehicle occupants in the event of an accident

## Multimedia systems

In addition to the standard-fit USB, Bluetooth® and SD card interfaces, there is the option of SPLITVIEW and the Harman Kardon® Logic 7® surround sound system for superb in-car entertainment

**COMAND APS** (part of the Navigation package). The multimedia system combines telephone, audio, video and hard-disc navigation, showing the information on a central colour display. The built-in DVD player can handle CDs and MP3 files, as well as playing video and audio DVDs. In addition, MUSIC REGISTER can store up to 2500 music tracks. Using Music Search you can search through this database by track title



COMAND Controller in the centre console

or artist name, for example, to quickly find the music you want. The display shows maps – when navigating for instance – in 3D. COMAND APS receives European map updates free of charge for three years after the vehicle is first registered. Plus, there is LINGUATRONIC for simple voice control of a host of functions.

**SPLITVIEW** (part of the Front Seat Entertainment package). SPLITVIEW is an innovative display technology that allows the driver and front passenger to each view a different picture on a single screen. While the driver looks at navigation information, for example, the front passenger can compile their own personal entertainment programme and listen through wireless headphones.



SPLITVIEW displays two different images at the same time – for the driver (1) and front passenger (2) – on a single screen

**Harman Kardon® Logic 7® surround sound system** (part of the Front Seat Entertainment package). Excellent, further-enhanced sound quality is provided by the Harman Kardon® Logic 7® surround sound system. It combines surround sound in Dolby Digital 5.1, a 13-channel DSP amplifier, 14 speakers specially tuned to the car's interior and a subwoofer. The 3D stereo sound is music to the ears, whilst the speed-sensitive volume control provides a consistent audio experience.

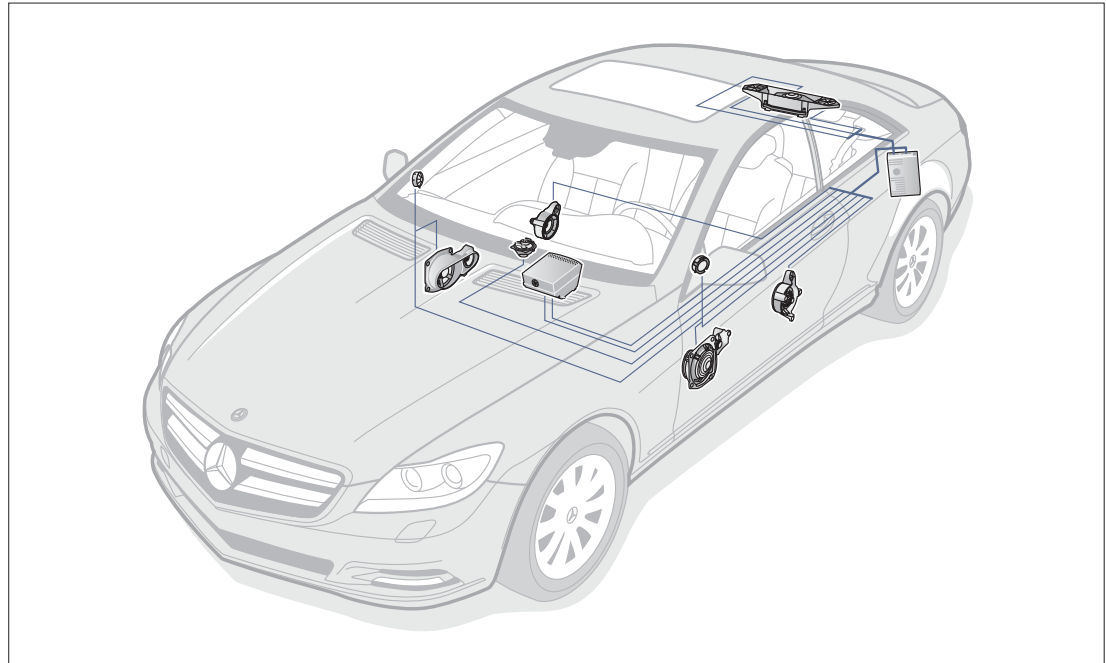

The Harman Kardon® Logic 7® surround sound system offers a first-class listening experience in the CL

## Assistance systems

Numerous assistance systems help to enhance driving comfort and make life even easier for drivers of the CL



All-round visibility when parking and reversing – thanks to the optionally available reversing camera

**Reversing camera** (option, standard for CL 600 and CL 65 AMG). The reversing camera assists the driver by affording a better view of the area around the tail end of the car. A wide-angle lens is built into the boot handle. The reversing camera is activated automatically when reverse gear is engaged and sends its image of the area immediately behind the car to the COMAND display.

**PARKTRONIC including Parking Guidance** (standard). The Parking Guidance system measures parking spots automatically to help the driver first find a suitable space and then park in it. The readings from ultrasonic sensors are used to determine whether a parking spot is large enough. The parking situation is then shown on the multifunction display. Yellow markings on



the display indicate the path that needs to be steered and red markings the path currently being steered. When the two overlap, they turn green. The PARKTRONIC display also indicates the current distance to obstacles.

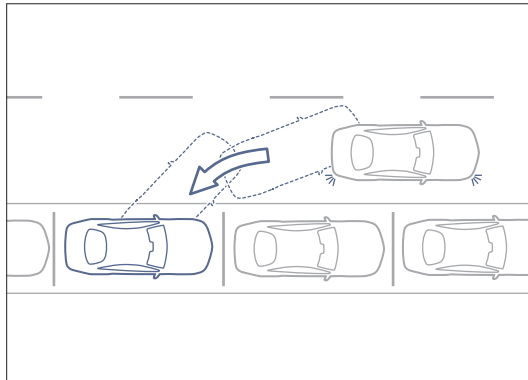

Parking Guidance provides parking instructions

**Speed Limit Assist** (part of the Navigation package). A windscreen-mounted camera that permanently scans the car's surroundings is able to recognise signed speed limits and indicate the detected maximum speed to the driver in the display. The driver can therefore check the



Parking Guidance is easy to use

prevailing speed limit at any time. This added convenience is of particular benefit on routes with variable speed limits or roadworks.



Speed Limit Assist display in the instrument cluster

## Climate control

A pleasant interior climate increases passenger comfort and driver-fitness safety aboard the CL

**Automatic climate control** (standard). The automatic climate control system allows the driver and front passenger to adapt the climate in their respective seats to suit their personal requirements independently of one another, and main-



Preferred temperatures can be set individually at the push of a button

tains the temperature at the desired level automatically. There is a solar sensor on the windscreen, for example, to monitor the intensity and direction of the sun's rays. There is a separate control for varying the front footwell



Climate control function in COMAND

temperature in relation to the rest of the interior. Further standard features include air recirculation, a cooled glove compartment, plus the combination dust and activated charcoal filter, which filters out particulate matter and improves overall air quality.

So there's always a pleasant atmosphere inside the CL. Not only does this increase comfort levels, it helps the driver to concentrate too, meaning greater safety for all occupants.

# Seats

The specially styled seats in the CL satisfy the most exacting standards as far as ergonomics, comfort and safety are concerned

**Active multicontour seats** (standard, option for CL 500 BlueEFFICIENCY). The massage and dynamic function offers an exceptional degree of comfort on longer trips. A series of air chambers can be adjusted to suit individual body shapes,



Comfortable individual seats in the rear

while the seat's side bolsters adjust dynamically in line with the car's movements. The 4-way lumbar support also makes for supreme seating comfort.



The active multicontour front seats with a massage and dynamic function

**Climatised front seats** (option, standard in CL 600, CL 63 AMG and CL 65 AMG). The ventilation and heating controls ensure a pleasant seat climate.

## CL 500 BlueEFFICIENCY

Masterful in every respect – the CL 500 BlueEFFICIENCY is a perfect counterpart for highly successful drivers

The CL 500 BlueEFFICIENCY comes with a metallic paint finish and 5-spoke light-alloy wheels with 255/45 R 18 tyres as standard. It is further distinguished by the LED Light package, comprising bi-xenon headlamps, Intelligent Light System, Adaptive Highbeam Assist as well as LED daytime running lamps with chrome surrounds. The doorhold function also forms part of the standard specification, as



The CL 500 BlueEFFICIENCY has a self-assured air about it

does the EASY-ENTRY system with automatic steering wheel adjustment. The interior is given an exclusive flair by trim made from select woods in three different grain patterns and fine leather in five delicately coordinated colour combinations. The electrically adjustable heated front seats with 4-way lumbar support promise top-class comfort. Thanks to the COMAND control and display system, all of the main entertain-



Multifunction steering wheel in nappa leather

ment and communications functions are integrated into a single, user-friendly colour screen. High levels of driving safety are ensured by standard-fit systems such as ATTENTION ASSIST and Active Body Control ABC including cross-wind stabilisation. There is also PARKTRONIC including Parking Guidance to help with parking.



## CL 500 4MATIC BlueEFFICIENCY

Keeping all four wheels firmly on the ground – the CL 500 4MATIC BlueEFFICIENCY

Drivers are able to enjoy exceptionally high levels of traction in all weathers in the CL 500 equipped with the permanent all-wheel drive system 4MATIC. This system splits the drive torque between the two axles in the ratio 45 : 55, thereby maximising vehicle grip and increasing handling stability in adverse road conditions. All with just a small fuel penalty compared to the two-wheel-drive model. Plus, there is the electron-

ically controlled damping system AIRMATIC with all-round self-levelling for excellent road roar and tyre vibration characteristics and handling safety.

Standard equipment for the CL 500 4MATIC BlueEFFICIENCY includes 15-spoke light-alloy wheels with 255/45 R 18 tyres, active multi-contour front seats with a massage and dynamic

function plus PRE-SAFE® positioning function, as well as an interior upholstered in Exclusive PASSION leather. Winter sports enthusiasts will be pleased to know a handy ski bag is also included as standard to protect the interior.



4MATIC, the all-wheel drive system from Mercedes-Benz

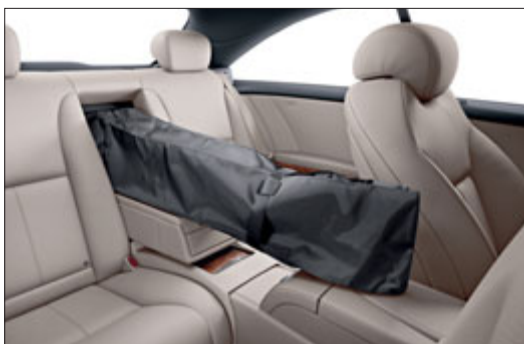

The ski bag protects the exclusive interior appointments



The 15-spoke light-alloy wheels

## CL 600

Well thought-out details and a wealth of luxurious appointments in the CL 600 make for supremely relaxed motoring

The CL 600 rides on V12-design light-alloy wheels shod with 255/45 R 18 tyres at the front and 275/45 R 18 tyres at the rear. At the front is an imposing radiator grille with V12 styling and two twin louvres, while V12 emblems on the wings, a chrome-plated boot sill and the two sets of twin tailpipes with vertical ribs incorpo-



The V12 logo appears in the start screen when the engine of the CL 600 is fired

rated into the rear bumper further differentiate it from the CL 500 BlueEFFICIENCY.

The fine interior appointments come in the form of the Exclusive PASSION Leather package with its V12-piping design, adding eye-catching touches to the upholstery and roof lining. The



The chrome-plated boot sill and the tailpipes with vertical ribs incorporated into the rear bumper

interior design is rounded off perfectly by the hand-picked high-gloss brown poplar wood with a V12 emblem and the wood/leather steering wheel made of the same high-quality material. The look is completed with selected details such as floor mats in velour with a V12 emblem and chromed door sill panels in a V12 design.

The CL 600 naturally comes with an extensive standard specification besides this, including KEYLESS-GO, ambient lighting, active multicontour and climatized front seats, COMAND APS, Harman Kardon® Logic 7® surround sound system, SPLITVIEW, as well as the reversing camera, an electric roller blind for the rear window and the Anti-Theft Protection package.



The front end of the CL 600 sporting a striking radiator grille and standard-fit LED daytime running lamps, as well as LED indicators and side lamps

## CL 63 AMG

Bringing racetrack performance to the open road – the CL 63 AMG → [www.mercedes-amg.com](http://www.mercedes-amg.com)



The CL 63 AMG boasts all the essential qualities of an exceptional athlete – power, endurance and speed



This is a car that lives up to first impressions: the CL 63 AMG greets the driver with a dynamic, muscular front apron incorporating AMG-specific LED daytime running lamps and a black cross strut, plus powerful side sill panels. The AMG-styled radiator grille with its single chrome-edged louvre is just as eye-catching as the new vehicle-coloured diffuser-look rear apron. The chrome twin tailpipes also feature a sporty design, as do the triple-spoke AMG light-alloy wheels with 255/40 R 19 tyres at the front and 275/40 R 19 at the rear. To further emphasise the car's mighty looks, twin-spoke AMG forged wheels from the AMG Performance Studio can be fitted, with tyre dimensions of 255/35 R 20 at the front and 275/35 R 20 at the rear.

The cockpit clearly bears the stamp of AMG too: there is an AMG sports steering wheel with silver-coloured aluminium shift paddles and an AMG instrument cluster with an AMG V8 start-up screen and main menu with RACETIMER function. The menu displays information such as the selected gear and engine oil temperature,



AMG sports seats upholstered in PASSION leather with an exclusive AMG seat upholstery layout and natural leather in the side bolsters

and the RACETIMER can even clock lap times. The IWC-designed analogue clock goes perfectly with the standard trim in high-gloss dark brown burr walnut or optional AMG carbon-fibre trim. PASSION leather upholstery with a special AMG seat upholstery layout puts the final touch to the CL 63 AMG's sporty air.



AMG sports steering wheel with silver-coloured aluminium shift paddles

## CL 63 AMG technology

Thrilling experiences at the wheel and impressive efficiency with the AMG 5.5-litre V8 twin-turbocharged engine and the AMG SPEEDSHIFT MCT 7-speed sports transmission → [www.mercedes-amg.com](http://www.mercedes-amg.com)

**AMG 5.5-litre V8 engine.** The AMG V8 twin-turbocharged engine in the CL 63 AMG impresses both with its sheer power and its efficiency. Up to 400 kW at 5250–5750 rpm and 800 Nm of torque – as much as 420 kW at 5500 rpm and 900 Nm of torque with the optional AMG Performance package – are on tap, but with its combined fuel consumption of only 10.5 l/100 km it sets standards in its segment. This is all thanks to the unique combination of innovative high-tech systems such as direct petrol injection, twin turbochargers, braking energy recuperation and Controlled Efficiency transmission mode with its start/stop function. And, just as you would expect from an AMG, it boasts a powerful, resonant engine sound.



The AMG 5.5-litre V8 twin-turbocharged engine with up to 420 kW and 900 Nm of torque

**AMG SPEEDSHIFT MCT 7-speed sports transmission.** Unites the best of both worlds, offering the sporty, direct and agile response of a manual and the supreme comfort of an automatic transmission. With the three driving modes Controlled Efficiency, Sport and Manual, drivers can decide how dynamically they want to change between the transmission's seven gears. Fast downshifting is a further strength of the AMG SPEEDSHIFT MCT 7-speed sports transmission; via kickdown you can change straight from seventh to fourth gear, for example, allowing the AMG V8 twin-turbocharged engine's power to be exploited to maximum effect.

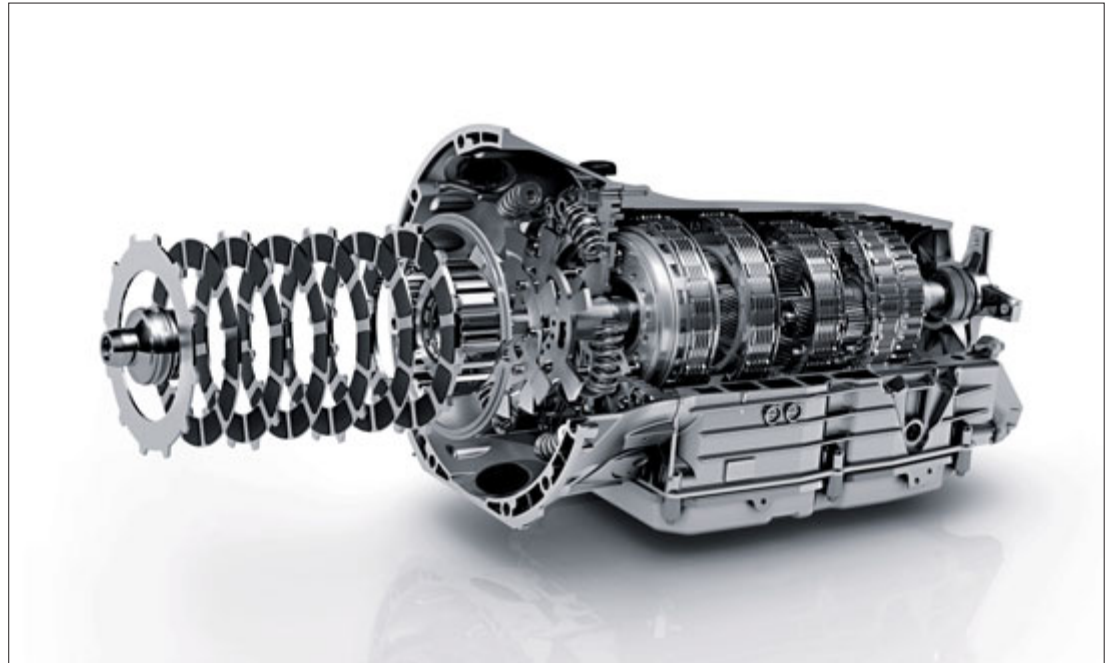

Fast and easy: changing gear with the AMG SPEEDSHIFT MCT 7-speed sports transmission

## CL 65 AMG

Prestige and effortless superiority in perfect harmony – the CL 65 AMG → [www.mercedes-amg.com](http://www.mercedes-amg.com)



The CL 65 AMG is a genuine athlete, shrouded in luxury and elegance



Radiating the same aura of sporty elegance as the CL 63 AMG, this model's 5-twin-spoke forged wheels with 255/35 R 20 sized tyres at the front and 275/35 R 20 at the rear, the two V12-design chromed twin tailpipes, as well as the "V12 BITURBO" lettering on the front wings provide telltale signs of its true power and dynamism. Both the CL 63 AMG and CL 65 AMG can be further customised with options such as the AMG Exterior Carbon-Fibre package: here, the front apron's cross strut, exterior mirror housings and the insert in the rear apron are all made from carbon fibre.

The CL 65 AMG is just as exclusive on the inside. The seat backrests' specially moulded contours ensure superb support – even when powering through corners. The Exclusive PASSION Leather package upholstery in AMG V12 design

covering the AMG sports seats and door centre panels combines with the rest of the package's appointments to add to the unique sense of sportiness.

The instrument cluster with its special AMG V12 start-up screen impresses with a 360-km/h dial



Exclusive PASSION Leather package featuring AMG sports seats with an AMG-specific upholstery layout

and the AMG main menu. Sporty elegance is exuded by the sports pedals made of brushed stainless steel featuring rubber studs and the AMG sports steering wheel with silver-coloured aluminium shift paddles.



Chromed twin tailpipes in V12 design

## Standard equipment | Selection



Multifunction steering wheel in nappa leather



COMAND colour display



Memory function for front seats



Telephone keypad



LED daytime running lamps



LED tail lights

## Optional extras | Selection



Active Blind Spot Assist



Ambient lighting in three colour shades<sup>1</sup>



KEYLESS-GO<sup>1</sup>



Harman Kardon® Logic 7® surround sound system<sup>1</sup>



Night View Assist Plus<sup>1</sup>



SPLITVIEW<sup>1</sup>

<sup>1</sup> Standard specification for CL 600 and CL 65 AMG

## AMG Sports package

### Dynamic styling and a prestigious brand of sportiness

The AMG Sports package injects the CL with even more dynamism. It begins on the outside with a powerfully moulded AMG front apron and side sill panels, continuing all the way back to the distinctive AMG rear apron.



Dynamism with just the right dose of prestige

The stunning look is completed by 5-spoke AMG light-alloy wheels with a high-sheen finish, shod with 255/40 R 19 front and 275/40 R 19 rear tyres (see page 77). Twin-spoke AMG forged wheels with 255/35 R 20 front and 275/35 R 20 rear



The distinctive rear apron – part of the AMG Sports package

tyres (as shown in the right-hand picture below) are also available as an option. Another distinguishing feature vis-à-vis the standard model is the painted front callipers with “Mercedes-Benz” lettering. There are even more differences inside, including wood trim in high-gloss black ash. Then there is the wood/leather steering wheel and, finally, the rubber-studded sports pedals made from brushed stainless steel and the matching AMG floor mats in black velour. The AMG Sports package is available for the CL 500 BlueEFFICIENCY, CL 500 4MATIC BlueEFFICIENCY and CL 600 models.





The AMG Sports package lends the CL a sporty, dynamic aura

## designo

A wealth of high-grade appointments and special details make designo an alluring proposition → [www.mercedes-benz.com/designo](http://www.mercedes-benz.com/designo)

The handcrafted designo range offers almost unlimited scope for customisation with its wide choice of colours, select trim options and exquisite materials. There are ten variants on

offer just for the exterior paintwork of your CL, including three exclusive matt paint finishes (magno).

Moving inside, there is a choice of designo aniline leather or designo natural leather in a variety of colours. Plus, customers can select from a wide range of stylistically matched wood or stone trim elements, such as wafer-thin polished stone or high-gloss piano lacquer, applied in up to ten coats.

The characteristic seat upholstery layout with ten-rib vertical piping and the designo badge in the seat backrests also help to lend the interior an extra-special feel, as do the wood/leather steering wheel and roof lining in fabric, Alcantara® or black leather.



Exterior paintwork in designo magno cashmere white (049)

designo is sure to give added impact to the exclusive nature of the CL, whether it is with harmonious colour combinations or boldly contrasting highlights.

Further designo features and information can be found on the website, where you also have the opportunity to visualise your dream car.



designo selection with designo logo in 18-carat gold



Door panel in designo light brown Exclusive aniline leather (X35)



Upholstery in designo light brown Exclusive aniline leather (X35) with trim in black designo piano lacquer (W69)

## Upholstery and trim







The black colour scheme offers a choice between leather seat upholstery (standard) or, depending on the model, either PASSION leather or Exclusive PASSION Leather package upholstery. The interior (dashboard, steering wheel, centre console, side panels and carpet) is finished in black throughout. In conjunction with the Exclusive PASSION Leather package, the dashboard, door linings, seatback panels, ruffled pockets and parcel shelf are additionally trimmed in leather, while the roof as well as the A- and C-pillars are lined in Alcantara®.

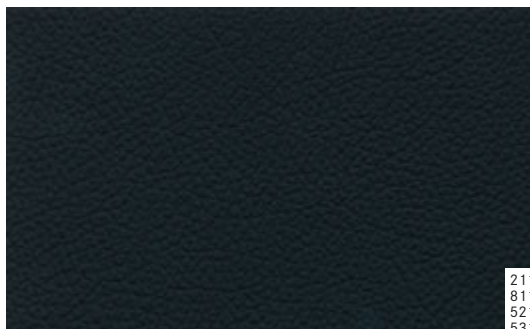

211  
811  
521  
531



H14



731



736



H18

---

#### BLACK/BLACK

---

- 211 Leather
- 811 PASSION leather<sup>1</sup>
- 521 Exclusive PASSION Leather package<sup>1</sup>
- 531 Exclusive PASSION Leather package<sup>2</sup>

---

#### TRIM

---

- H14 High-gloss light brown burr walnut wood
  - 731 High-gloss dark brown burr walnut wood<sup>3</sup>
  - 736 High-gloss black ash wood
  - H18 High-gloss brown poplar wood<sup>4</sup>
- 

<sup>1</sup> Option   <sup>2</sup> Standard for V12   <sup>3</sup> Standard for V8, option for V12   <sup>4</sup> Only for V12



The cashmere beige/savanna beige colour scheme includes leather upholstery, the lower dashboard section, centre console and door interiors in cashmere beige. The upper section of the dashboard, the steering wheel, door edges and carpet are finished in savanna beige. The same colour combination is also available for either the PASSION leather or Exclusive PASSION Leather package variants, depending on the particular model. The latter option includes a PASSION leather trim for the dashboard, door linings, seatback panels, ruffled pockets and parcel shelf. The roof and the A- and C-pillars are again lined in Alcantara® to add an extra touch of class.

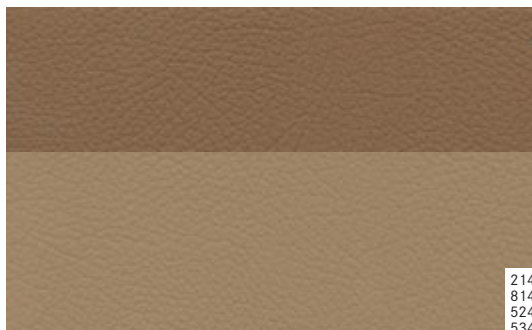

214  
814  
524  
534



H14



731



736



H18

---

#### CASHMERE BEIGE/SAVANNA BEIGE

---

- 214 Leather
- 814 PASSION leather<sup>1</sup>
- 524 Exclusive PASSION Leather package<sup>1</sup>
- 534 Exclusive PASSION Leather package<sup>2</sup>

---

#### TRIM

---

- H14 High-gloss light brown burr walnut wood
  - 731 High-gloss dark brown burr walnut wood<sup>3</sup>
  - 736 High-gloss black ash wood
  - H18 High-gloss brown poplar wood<sup>4</sup>
- 

<sup>1</sup> Option <sup>2</sup> Standard for V12 <sup>3</sup> Standard for V8, option for V12 <sup>4</sup> Only for V12



The alpaca grey/basalt grey colour scheme includes leather upholstery, the lower dashboard section, centre console, door interiors and carpet in alpaca grey. The upper section of the dashboard, the steering wheel and door edges are finished in basalt grey. The PASSION leather or Exclusive PASSION Leather package appointments are available in the same colour combination, either as standard or optionally depending on the model. The latter option includes a PASSION leather trim for the dashboard, door linings, seatback panels, ruffled pockets and parcel shelf. The roof as well as the A- and C-pillars are lined in Alcantara® to add an extra touch of class.

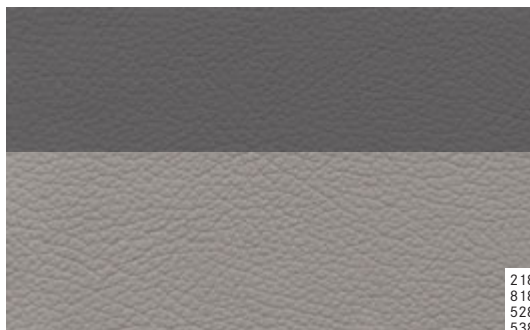

218  
818  
528  
538



H14



731



736



H18

---

#### ALPACA GREY/BASALT GREY

---

- 218 Leather
- 818 PASSION leather<sup>1</sup>
- 528 Exclusive PASSION Leather package<sup>1</sup>
- 538 Exclusive PASSION Leather package<sup>2</sup>

---

#### TRIM

---

- H14 High-gloss light brown burr walnut wood
  - 731 High-gloss dark brown burr walnut wood<sup>3</sup>
  - 736 High-gloss black ash wood
  - H18 High-gloss brown poplar wood<sup>4</sup>
- 

<sup>1</sup> Option   <sup>2</sup> Standard for V12   <sup>3</sup> Standard for V8, option for V12   <sup>4</sup> Only for V12



The Sahara beige/black colour scheme includes leather upholstery, the lower dashboard section, lower centre console and door interiors in Sahara beige. The upper section of the dashboard, the steering wheel, upper centre console, door edges and carpet are finished in black. The same colour combination is also available for either the PASSION leather or Exclusive PASSION Leather package variants, depending on the particular model. The latter option includes a PASSION leather trim for the dashboard, door linings, seatback panels, ruffled pockets and parcel shelf. The black Alcantara® lining for the roof and the A- and C-pillars adds touches of contrasting colour.

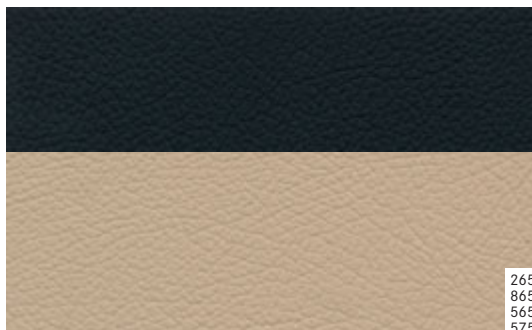

265  
865  
565  
575



H14



731



736



H18

---

#### SAHARA BEIGE/BLACK

---

- 265 Leather
  - 865 PASSION leather<sup>1</sup>
  - 565 Exclusive PASSION Leather package<sup>1</sup>
  - 575 Exclusive PASSION Leather package<sup>2</sup>
- 

#### TRIM

---

- H14 High-gloss light brown burr walnut wood
  - 731 High-gloss dark brown burr walnut wood<sup>3</sup>
  - 736 High-gloss black ash wood
  - H18 High-gloss brown poplar wood<sup>4</sup>
- 

<sup>1</sup> Option, not available for CL 63 AMG <sup>2</sup> Only for CL 600

<sup>3</sup> Standard for V8, option for V12 <sup>4</sup> Only for V12





The aubergine/black colour scheme includes leather upholstery, the lower dashboard section, lower centre console and door interiors in aubergine. The upper section of the dashboard, the steering wheel, door edges and carpet are finished in black. The PASSION leather or Exclusive PASSION Leather package appointments that are available either as standard or optionally, depending on the model, come in the same colour combination. The latter option includes a PASSION leather trim for the dashboard, door linings, seatback panels, ruffled pockets and parcel shelf. The black Alcantara® lining for the roof and the A- and C-pillars provides the perfect finishing touch.

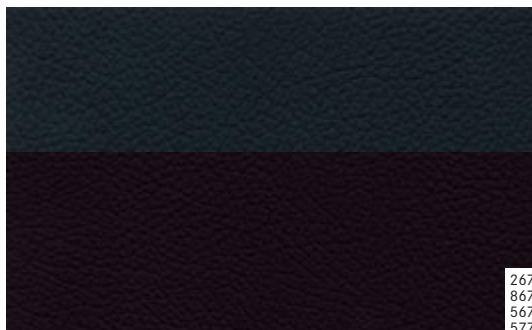

267  
867  
567  
577



H14



731



736



H18

---

#### AUBERGINE/BLACK

---

- 267 Leather
- 867 PASSION leather<sup>1</sup>
- 567 Exclusive PASSION Leather package<sup>1</sup>
- 577 Exclusive PASSION Leather package<sup>2</sup>

---

#### TRIM

---

- H14 High-gloss light brown burr walnut wood
  - 731 High-gloss dark brown burr walnut wood<sup>3</sup>
  - 736 High-gloss black ash wood
  - H18 High-gloss brown poplar wood<sup>4</sup>
- 

<sup>1</sup> Option, not available for CL 63 AMG    <sup>2</sup> Only for CL 600

<sup>3</sup> Standard for V8, option for V12    <sup>4</sup> Only for V12

## Wheels



V12 5-spoke light-alloy wheels with 255/45 R 18 front and 275/45 R 18 rear tyres (standard for CL 600)



7-twin-spoke light-alloy wheels, high-shine finish, with 255/45 R 18 front and 275/45 R 18 rear tyres, 255/45 R 18 tyres all round on 4MATIC models (optional)



5-Y-spoke light-alloy wheels for 255/40 R 19 front and 275/40 R 19 rear tyres, 255/40 R 19 tyres all round on 4MATIC models, titanium silver, high-shine finish (optional)



5-spoke light-alloy wheels with 255/45 R 18 tyres all round (standard for CL 500 BlueEFFICIENCY)



15-spoke light-alloy wheels with 255/45 R 18 front and 275/45 R 18 rear tyres, 255/45 R 18 tyres all round on 4MATIC models (optional, standard for CL 500 4MATIC BlueEFFICIENCY)



10-spoke light-alloy wheels with 255/45 R 18 front and 275/45 R 18 rear tyres, 255/45 R 18 tyres all round on 4MATIC models (optional)



Multi-spoke light-alloy wheels with 255/40 R 19 front and 275/40 R 19 rear tyres, 255/40 R 19 tyres all round on 4MATIC models (optional)



5-spoke light-alloy wheels with 255/40 R 19 front and 275/40 R 19 rear tyres, 255/40 R 19 tyres all round on 4MATIC models (optional)



Triple-spoke AMG light-alloy wheels with 255/40 R 19 front and 275/40 R 19 rear tyres (standard for CL 63 AMG)



Twin-spoke AMG forged wheels with 255/35 R 20 front and 275/35 R 20 rear tyres, titanium grey, polished finish (standard for CL 65 AMG, option for CL 63 AMG)



10-spoke "Alaraph" light-alloy wheels with 255/35 R 20 front and 275/35 R 20 rear tyres, 255/35 R 20 tyres all round on 4MATIC models, sterling silver (ex-factory accessories)



5-spoke AMG light-alloy wheels with 255/40 R 19 front and 275/40 R 19 rear tyres, 255/40 R 19 tyres all round on 4MATIC models, high-sheen finish (AMG Sports package)



5-twin-spoke AMG light-alloy wheels with 255/35 R 20 front and 275/35 R 20 rear tyres, 255/35 R 20 tyres all round on 4MATIC models (optional)



Twin-spoke AMG forged wheels with 255/35 R 20 front and 275/35 R 20 rear tyres, black, polished finish (option for CL 63 AMG and CL 65 AMG)



5-spoke "Kiyali" light-alloy wheels with 255/35 R 20 front and 275/35 R 20 rear tyres, 255/35 R 20 tyres all round on 4MATIC models, high-sheen titanium silver (ex-factory accessories)

## Genuine accessories

A Mercedes-Benz is more than just a car. It can be a travel companion, an office, a living space. And this diversity is reflected in the Mercedes-Benz genuine accessories range



incenio "Maedis" 12-spoke light-alloy wheels<sup>1</sup> for 255/45 R 18 front and 275/45 R 18 rear tyres

<sup>1</sup> incenio light-alloy wheels are supplied without tyres

The Mercedes-Benz genuine accessories range for the CL features a host of ingenious and practical products. Take, for example, the dust cover made from elastic synthetic fibre, which is designed to protect your CL from dirt, dust and scratching. Or the sturdy chromed metal coat hangers, which can be simply attached to the back of the front head restraints for keeping items of clothing free of creases during the journey. The shallow boot tub is extremely handy for carrying even groceries and liquids. The tub's shape with its slightly raised rim is a perfect fit for the floor of the boot, while its ribbed structure provides





Boot tub, shallow



Coat hanger

better protection for the cargo against sliding around.

The genuine accessories range offers you a wide selection of top-quality items to choose from. Please see our accessories brochure for further details, or contact your authorised Mercedes-Benz dealer, who will be happy to advise you.



Dust cover

## Services

**MercedesCard.** The card is your ticket to the Mercedes-Benz experience. Four times a year, we will send you the Mercedes Magazine, featuring fascinating reports from the world of Mercedes-Benz and articles about our latest vehicles. A MercedesCard also has many other uses too. As a VISA credit card, it is an internationally accepted means of payment. Further benefits are available to provide you with peace of mind, such as insurance packages for your Mercedes and other insurance services for the whole family. Further details can be found at [www.mercedes-benz.com](http://www.mercedes-benz.com)<sup>1</sup>

**Mercedes-Benz Financial Services.** Mercedes-Benz stands for quality, innovation and safety – and the same applies to Mercedes-Benz Financial Services. Our innovative leasing and financing products are tailored to your financial needs and means, making it easy for you to secure the keys to your dream car. Once you are on the road, our insurance products offer you comprehensive protection on every trip. Finally, our

service products ensure that your car is always in tip-top condition whilst keeping costs transparent and easily manageable. For a detailed quotation, please contact your Mercedes-Benz dealer, who will be glad to go through the latest financial services and terms and conditions with you.

**Mercedes-Benz mobility.** Your new car comes complete with the promise of feeling safe on the road, but if you should ever need assistance, then Mercedes-Benz Service24h is there to help. Just call the freephone service hotline on 00800 1 777 7777<sup>2</sup>. The integrated telematics service, Mercedes-Benz Contact<sup>3</sup>, is even more customer friendly: a touch of a button is all it takes to contact the Mercedes-Benz customer centre. If you wish, the relevant vehicle and position-related data can be transmitted at the same time, thereby allowing the centre to react quickly and provide rapid on-the-spot assistance. Also standard with your new car at no extra charge is the Mercedes-Benz Mobilo<sup>4</sup> mobility package. Whether you have lost your key, had

a breakdown which cannot be repaired immediately or suffered damage to the vehicle due to an accident or vandalism, Mobilo is there to help you reach your destination – anywhere in Europe. Whatever your problem, one thing is certain: you will soon be able to resume your journey.

**Mercedes-Benz Museum.** Experience 125 years of automotive history against an architecturally impressive backdrop. Over 1500 exhibits on nine levels give you an insight into the unique tradition and powers of innovation of the Mercedes-Benz brand in Stuttgart. See the world's first two automobiles in the shape of the Benz Patent-Motorwagen (motor car) and the Daimler motorised carriage – plus the automotive future of Mercedes-Benz – in an area covering a total of 16,500 square metres. We look forward to your visit – online, too, at [www.mercedes-benz-classic.com/museum](http://www.mercedes-benz-classic.com/museum)

<sup>1</sup> Information about the MercedesCard in Austria and Switzerland can be found on the Mercedes-Benz websites for these countries <sup>2</sup> Alternative: +49 69 95 30 72 77. The only charge incurred is the cost of the mobile phone call to the landline network

**Test drive.** The unique feeling of driving a Mercedes cannot be put into words. Which is why we'd like to invite you to experience it for yourself. Take a test drive and find out first hand how it feels to drive your dream car. Simply visit [www.mercedes-benz.com](http://www.mercedes-benz.com) to locate your nearest Mercedes-Benz dealer.

**Interactive Owner's Manual.** The website also offers an interactive tour, enabling you to take a closer look at your desired model. Experience key functions in detail, gain an insight into the car's inner workings or look at the benefits of each model at [www.mercedes-benz.de/owners-manual](http://www.mercedes-benz.de/owners-manual)

**Mobile internet.** Now you can access the entire world of Mercedes-Benz from your mobile phone. As well as an overview of all the passenger car models, there are insights into the entire brand world along with a wealth of entertainment offers and direct links to our range of services at [www.mercedes.mobi](http://www.mercedes.mobi)

**Service packages.** Vehicle-specific services allow you to put together an individual package for your Mercedes-Benz: for a small monthly premium the Excellent service package covers all service jobs including maintenance, wear and repairs – for up to five years. Simply present your service card to avoid any financial surprises. And you can be sure that your Mercedes-Benz will remain on top form for a long time to come. With the Advance service package your Mercedes-Benz will stay at its best for longer still: you are protected against unexpected repair costs even after the manufacturer's warranty or the service package has expired – for up to ten years.



**Repair following an accident.** Should the worst come to the worst, the Mercedes-Benz accident repair service provides you with the best help available for your vehicle, which will retain its valuable safety properties. From work on the paint to bodywork or glass damage – optimally trained specialists will repair your Mercedes-Benz at your Mercedes-Benz service partner, and you will soon be back on the road again. Further information is available from your authorised Mercedes-Benz dealer.



<sup>3</sup> Requires a factory-fitted radio, connected to an operational mobile phone. The only charge incurred is the cost of the mobile phone call to the landline network <sup>4</sup> Once the warranty for breakdowns has expired (four years), Mobilo can be extended in periods of one year for a maximum of 30 years, provided that regular maintenance is carried out by your Mercedes-Benz service partner

## Dimensions

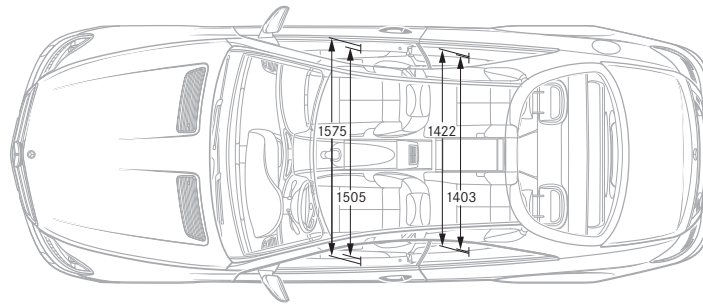
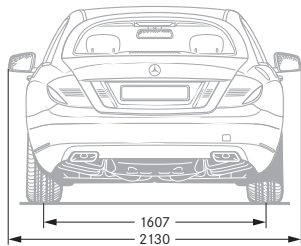
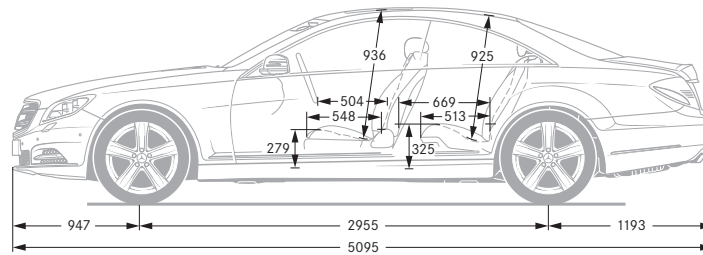
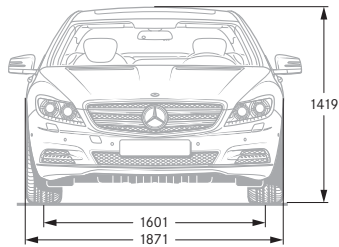

## Paintwork

### NON-METALLIC PAINT (standard)

040 black

### METALLIC PAINTS (standard)

183 magnetite black

197 obsidian black

300 periclase green

370 andorite grey

474 peridot brown

544 carneol red

775 iridium silver

792 palladium silver

890 cavansite blue

### SPECIAL METALLIC PAINTS (option)

228 cornetite blue

799 diamond white BRIGHT



## Technical data

PETROL ENGINES	CL 500 BlueEFFICIENCY	CL 500 4MATIC BlueEFFICIENCY
No. of cylinders/arrangement	8/V	8/V
Total displacement (cc)	4663	4663
Rated output <sup>1</sup> (kW at rpm)	320/5250	320/5250
Rated torque <sup>1</sup> (Nm at rpm)	700/1800–3500	700/1800–3500
Acceleration from 0 to 100 km/h (s)	4.9	4.9
Top speed, approx. (km/h)	250 <sup>2</sup>	250 <sup>2</sup>
Tyre size – front axle, rear axle	255/45 R 18, 255/45 R 18	255/45 R 18, 255/45 R 18
Fuel consumption <sup>3</sup> (l/100 km)		
Urban	13.9–13.5	14.0–13.9
Extra-urban	7.6–7.2	7.9–7.6
Combined	9.9–9.5	10.1–9.9
CO <sub>2</sub> emissions <sup>3</sup> (g/km) combined	232–224	242–237
Efficiency class	E	E
Emission class	Euro 5	Euro 5
Max. boot capacity (l)	490	490
Kerb weight <sup>4</sup> (kg)	2070	2120
Perm. GVW (kg)	2585	2555

<sup>1</sup> Figures in accordance with Directive 80/1269/EEC in the currently applicable version <sup>2</sup> Electronically governed <sup>3</sup> The figures shown were obtained in accordance with the prescribed measuring process (Directive 80/1268/EEC in the currently applicable version). The figures are not based on an individual vehicle and do not constitute part of the product offer; they are provided solely for purposes of comparison between different vehicle models

CL 600	CL 63 AMG	CL 65 AMG
12/V	8/V	12/V
5513	5461	5980
380/5000	400/5250-5750 (420/5500 <sup>5</sup> )	463/4600-5000
830/1800-3500	800/2000-4500 (900/2250-3750 <sup>5</sup> )	1000/2300-4300
4.6	4.5 (4.4 <sup>5</sup> )	4.4
250 <sup>2</sup>	250 <sup>2</sup> (300 <sup>5</sup> )	250 <sup>2</sup>
255/45 R 18, 275/45 R 18	255/40 ZR 19, 275/40 ZR 19	255/35 ZR 20, 275/35 ZR 20
21.2-21.1	14.4	21.8
9.9-9.6	8.2	9.9
14.0-13.8	10.5	14.3
328-322	244	334
G	E	G
Euro 5	Euro 5	Euro 5
490	490	490
2185	2135	2245
2620	2585	2645

<sup>4</sup> Figures in accordance with Directive 92/21/EC, version 95/48/EC (kerb weight with fuel tank 90% full, driver, 68 kg, and luggage, 7 kg) for standard-specification vehicles. Optional extras and accessories will generally increase this figure and reduce the payload capacity accordingly <sup>5</sup> In conjunction with AMG Performance package, Code P30 Further technical data can be found at [www.mercedes-benz.com](http://www.mercedes-benz.com)

NON-METALLIC PAINT



040

METALLIC PAINTS



183

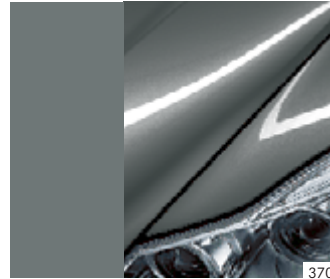

370



775

SPECIAL METALLIC PAINTS

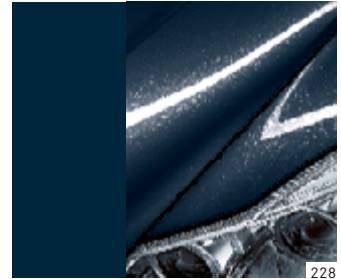

228



197



474



792



799



300



544



890

**Take-back of end-of-life vehicles.** Coming full circle. At the end of its long life, you can return your CL-Class to us for environment-friendly disposal in accordance with the EU End-Of-Life Vehicle Directive<sup>1</sup>. But that day lies a long way off.

<sup>1</sup> Applies in accordance with national regulations to vehicles up to 3.5 tonnes gross weight. Mercedes-Benz passenger cars have met the statutory regulations governing the suitability of their design for reuse and recycling for a number of years now. A network of vehicle take-back depots and dismantlers has been established which will process your vehicle in an environment-friendly manner. The ways in which both vehicles and parts can be recovered are subject to ongoing development and improvement. Consequently, the CL-Class will be able to comply with any future increases in the recycling quota within the stipulated time limits. For further information: [www.mercedes-benz.com](http://www.mercedes-benz.com)

**Please note:** changes may have been made to the product since this brochure went to press (22.07.2011). The manufacturer reserves the right to make changes to the design, form, colour and specification during the delivery period, provided these changes, while taking into account the interests of the vendor, can be deemed reasonable with respect to the purchaser. Where the vendor or the manufacturer uses symbols or numbers to describe an order or the subject of an order, no rights may be derived solely from these. The illustrations may show accessories and items of optional equipment which are not part of standard specification. Colours may differ slightly from those shown in the brochure, owing to the limitations of the printing process. This brochure is distributed internationally. It provides a general indication of the range of models, features, optional extras and/or colours available in various countries. Some of the models, features, optional extras and/or colours shown may not be available in your country or may only be available in a different specification. Additionally some models, features, optional extras and/or colours may only be available in combination with others. For current and more specific information in relation to the range of models, features, optional extras and/or colours available in your country, and their pricing, you should contact your nearest authorised Mercedes-Benz Passenger Car Dealer.  
[www.mercedes-benz.com](http://www.mercedes-benz.com)