

This Brochure is prepared by Daimler AG and it predominantly reflects the capabilities and performance of vehicles sold in Europe. Some characteristics, capabilities, performance features and optional extras (e.g. towing systems) may not be available or may not apply in Australia or under Australian conditions. The information in this Brochure is therefore indicative, illustrative and provided only for guidance and should not be relied on. To obtain current and accurate information on a vehicle and any options applicable to Australia, contact your local authorised Mercedes-Benz dealer.



Mercedes-Benz

The A-Class



Mercedes-Benz

The new A-Class is the car for a new era and a new generation. A car that wants it all and more. Are you geared to your personality and not vice versa? Just let yourself be guided by your style. It expels boredom from the street. And gives you an easy ride in the process. High-tech curves and convex sweeping lines – in a perfect rhythm for light shows. And sinewy with it, athletic and dynamic with AMG Sport. Even more “Me” with the three optional Design packages: an extravagant touch of heart, on that which you normally expect from Mercedes-Benz. The new A-Class is the car that lets you experience it for yourself. Equipment and appointments options which are geared to your personality. Non-conformist from the outside and quite the style icon inside. It expels boredom from the street and edges alongside tautly tensioned surfaces: concave curves, convex sweeping lines – dynamic elegance, urbane style or sporty through and through with AMG Sport. Even more “Me” after you. Sit **The pulse of a new generation.** at the wheel and steer the whole world. And, either: the electric parking brake, Active Parking Assist, reversing camera and HOLD



It is an unbridled attack: on your eyes, on your heart, on that which you normally expect from Mercedes-Benz. The new A-Class is the car for a new era and a new generation. A car that wants it all and makes no compromises. A design that is the spitting image of the future? Here it is. Unadulterated agility and efficient with it? Of course. Comfort and technology in a breathtaking symbiosis?

Climb on in and experience it for yourself. Equipment and appointments options which are geared to your personality and not vice versa? Just let yourself be guided by your style. And when you are then finally sitting in it and drive the first of many, many exciting metres, you will feel it in the new A-Class – the pulse of a new generation.

At a glance | from page 4 Insight | from page 22

The models presented:

A 250 | polar silver metallic | cover and from page 2

AMG Sport design and equipment line | Twin-spoke AMG light-alloy wheels, black ARTICO man-made leather /DINAMICA microfibre upholstery, carbon fibre look trim

A 200 | non-metallic jupiter red | from page 12

Style design and equipment line | 5-twin-spoke light-alloy wheels, black /white ARTICO man-made leather/fabric upholstery, black matrix-look trim

A 250 Sport – engineered by AMG | polar silver metallic | from page 18

AMG Sport design and equipment line | 5-twin-spoke AMG light-alloy wheels, black leather upholstery, carbon fibre look trim

The illustrations may include accessories and optional extras which do not form part of the standard specification

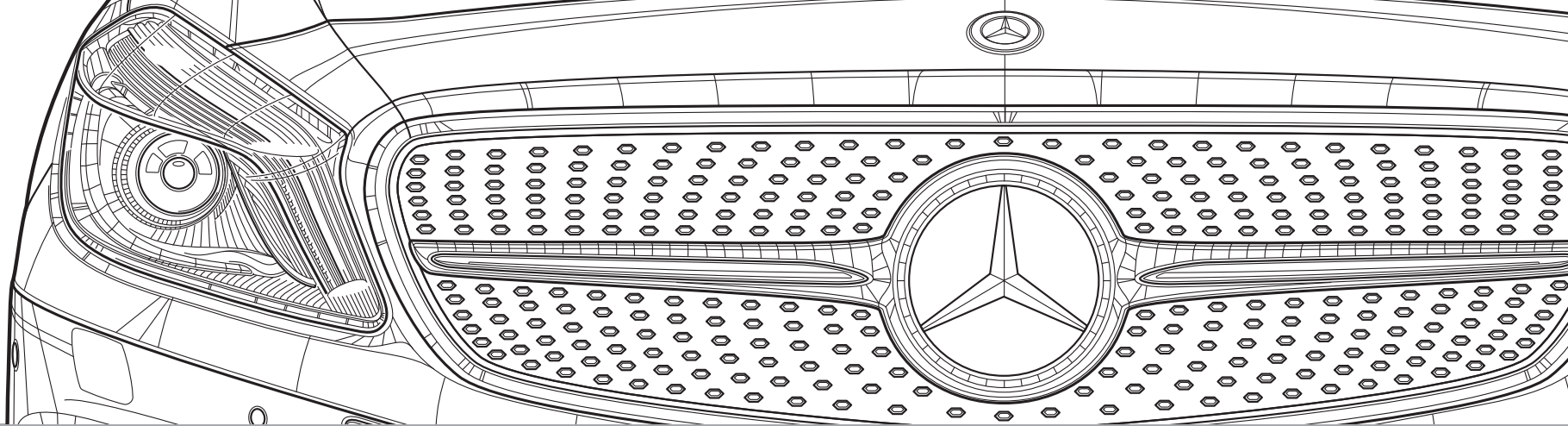

For motoring pleasure: BlueEFFICIENCY, diesel and petrol engines, transmissions and chassis.

Drive system & chassis | from page 28

For safety: assistance systems which can prevent accidents and minimise the consequences of accidents, such as ATTENTION ASSIST, COLLISION PREVENTION ASSIST, DISTRONIC PLUS and PRE-SAFE®.

Safety | from page 34

For relaxed driving: standard-specification and optional comfort, for example multimedia and assistance systems, climate control, and seats.

Comfort | from page 38

For top athletes: everything about the powerful sports model – engineered by AMG.

Model variants | from page 44

For individualists: generous standard equipment, optional design and equipment lines Style, Urban, AMG Sport plus Night, Exclusive and AMG Exclusive package, wheels and genuine accessories.

Equipment & appointments | from page 46

For all-round service: MercedesCard, Mercedes-Benz Financial Services, Mercedes-Benz mobility, Mercedes-Benz Museum, test drive, Interactive Owner's Manual, mobile internet, service packages, accident repairs.

Services | from page 72

For lovers of detail: dimensions, paintwork and technical data.

Facts & colours | from page 74



1 look*

*And you won't believe your eyes:
what a Mercedes!

Either for or against, complacency is not an option. Non-conformist from the outside and quite the style icon inside. It expels boredom from the street. And gives you an easy ride in the process. High-tech: it goes without saying. Safe: no question. Efficient: naturally. It could not be a more characteristic Mercedes. And at the same time very, very different. Hello, new A-Class!



130 bpm*

*When the view leaves you speechless,
the heart speaks volumes

An expression of pulsating life: defined edges alongside tautly tensioned surfaces: concave curves, convex sweeping lines – in a perfect rhythm for light shows. And sinewy with it, athletic like a coupé. Lit-up eyes included: this is what a portrait of the new A-Class sounds like.





1*

*Endless equipment options. And only one that sets the tone

Your head, your style, your personality, your A-Class. Three possible design and equipment lines, three confident statements: dynamic elegance, urbane style or sporty through and through with AMG Sport. Even more "Me" with three optional Design packages: an extravagant exterior in the Night package, high-quality details in the Exclusive package, sporty presence in the AMG Exclusive package. The new A-Class: a Mercedes-Benz where its genes are concerned. But it clearly takes after you.





Mercedes-Benz Apps

- Facebook
- Google Lokale Suche
- Nachrichten
- Drivestatistika

22:00 22°C

105 km
10

RADIO DISC

NAVI TEL

100 OK 150

100 150 200 250 300 350 400 450 500

AUTO ZONE 21°C 22°C

OFF BEST

MODE A/C

The background of the advertisement is a close-up, low-angle shot of a car's interior. It shows the top of the steering wheel with the Mercedes-Benz logo, the dashboard with a textured surface, and the upper part of the driver's seat. The lighting is dramatic, with strong highlights and deep shadows, creating a sense of depth and luxury. A red stitching detail is visible on the seat and dashboard.

800 x 480*

*The offline resolution:
the new COMAND Online

Sit at the wheel and steer the whole world. A full 17.8 cm display: your window to the web of possibilities. Surf in the browser, search with Google®, share on Facebook® and be there every bit of the way. And you won't be alone in any situation in the real world, either: the electric parking brake, Active Parking Assist, reversing camera and HOLD function support your motoring pleasure. Technology that makes it easier to be human.

> 1000 km*

*Every refuelling stop is something special.
Good for progress and bank balance alike

The new A-Class is a true endurance athlete. The economical consumption from 3.3 litres over 100 kilometres takes you further than you think. Through efficient engines with direct injection and turbocharging. And the standard-specification ECO start/stop function which also helps to put the brakes on consumption at red traffic lights. The very essence of BlueEFFICIENCY.









5 + 11*

*More perception
and less risk

Whenever the 5 senses reach their limits they are on hand: 11 assistance systems. Part of the standard specification in the new A-Class: the radar-based COLLISION PREVENTION ASSIST safety system, the ATTENTION ASSIST system and Hill-Start Assist. Even more safety on request: the DISTRONIC PLUS proximity control system and the PRE-SAFE® system. Technologies which can ensure that dangers do not come too close to you.





6.6 s*

*Sprint immediately: from 0 to 100 km/h in your best time

Off and away with a lasting impression. A well-exercised heart as a drive system: high-torque and efficient 4-cylinder petrol and diesel engines. From one gear to another without any interruptions with the optional dual clutch transmission 7G-DCT. Your finger on the pulse of the road: the Direct-Steer system and sports suspension in the optional Dynamic Handling package. An athlete where looks are concerned, too: with a diamond radiator grille and sports seats that have really earned their name. Don't drive off for less fun.







$$C_d = 0.27^*$$

*If you save on wind resistance,
you also save on consumption

The new A-Class: a body with such optimum flow that the air becomes short of breath. The result: a c_d value like that of notchback saloons. The advantage of this drawback: less fuel consumption, fewer fuelling stops. Pssst: this is how we have also reduced the wind noise.

California think-tank

There's something in the air in Palo Alto. It seems to vibrate when the Californian sun sends a new day full of brainwaves shining into the foothills of Silicon Valley.

Renowned universities and visionary start-ups spur each other on to attain maximum performance – like the segments of a hard disc they are in constant communication.

Mercedes-Benz Research & Development Center North America is also located at the heart of this seat of progress. The most diverse disciplines carry out research here into tomorrow's innovations: specialists such as user interface designers plus software and

hardware engineers are networking the digital lifestyle with the digital drive style. Cross-functional cooperation is the foundation for their working relationship.

And with their creative power they do not stop at the walls of the development centre in California. That is why these are coated with a special paint finish which allows them to be written on with pens. This accelerates the creative process, saves paper and makes it easier to think in all directions. An ability without which the car would never have been invented and which is indispensable for its future development.

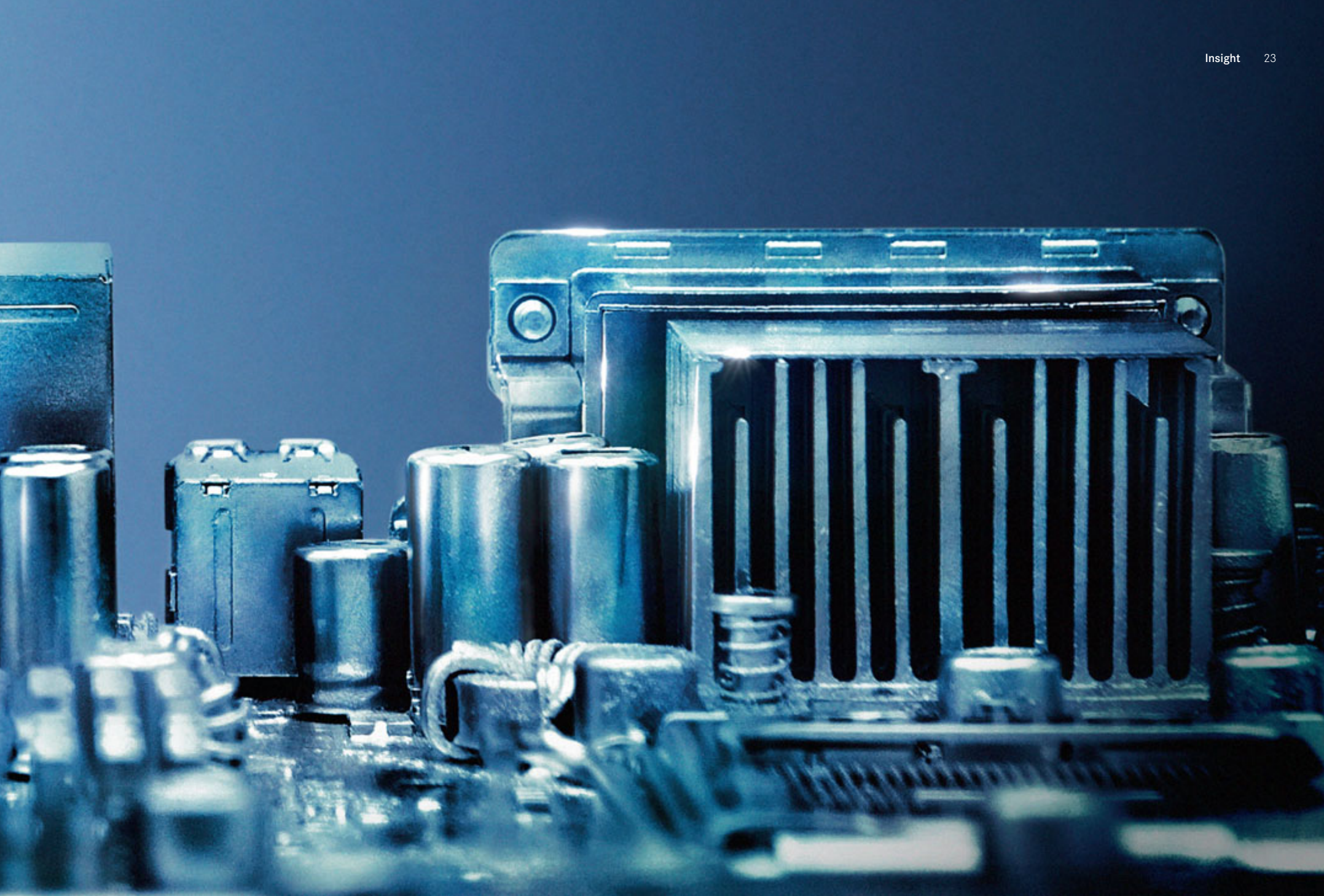

nt. Facts and colours. Metallic paints. Climate control. Seats. ESP[®]. Dimensions. Stand
light-alloy wheels. Top speed. Chassis & suspension. Facts and colours. Optional extras
work. Total displacement. Facts and colours. Climate control. Seats. ESP[®]. Dimensions
rive. Light-alloy wheels. Memory function. Transmissions. Surround sound system. WI
Services. Upholstery and trim. Assistance systems. Safety. Metallic paints. Petrol engi
Chassis & suspension. Optional extras. Fuel consumption. Interior. Airbags. LED daytime
control. Seats. ESP[®]. Dimensions. Standard equipment. Light. Multimedia systems. D
d sound system. Wheels. Interior. Acceleration. CO₂ emissions. Test drive. Environmen
tems. Upholstery and trim. Metallic paints. Petrol engines. Facts and colours. Acceler
Chassis & suspension. Fuel consumption. Drive system. Interior. Airbags. LED daytime
leration. ESP[®]. **The facts.** Paintwork. Total displacement. Climate control. Seats. Whee
transmissions. Surround sound system. Dimensions. Interior. Safe driving. Transmissi

28 **BlueEFFICIENCY**29 **A-Class BlueEFFICIENCY**30 **Diesel engines**

4-cylinder diesel engines

31 **Petrol engines**

4-cylinder petrol engines

32 **Transmissions**

6-speed manual transmission

7-speed dual clutch transmission

7G-DCT

33 **Chassis & suspension**

Chassis and steering

Sports suspension

Direct-Steer system

34 **Integral safety concept**

ATTENTION ASSIST

COLLISION PREVENTION ASSIST

ADAPTIVE BRAKE

DISTRONIC PLUS

Lane Keeping Assist/Blind Spot Assist

Intelligent Light System

PRE-SAFE® system

Active bonnet

Airbags

Mercedes-Benz emergency call system

Measures after an accident

38 **Multimedia systems**

COMAND Online

Drive kit for the iPhone®

Audio 20 CD

Becker® MAP PILOT

Harman Kardon® Logic 7®

surround sound system

40 **Assistance systems**

Reversing camera

Active Parking Assist,
including PARKTRONIC

Speed Limit Assist

41 **Light and climate control**

Light and Sight package

THERMOTRONIC

42 **Seats**

Seat Comfort package

4-way lumbar support

Electric seat adjustment

with Memory function

43 **Roof and space**

Panoramic sliding sunroof

Luggage compartment

Stowage Space package

44 **Sports model A 250 Sport –
engineered by AMG**

- 46 Equipment packages, including upholstery and trim**
 - Standard equipment
 - Style design and equipment line
 - Urban design and equipment line
 - AMG Sport design and equipment line
 - Night package
 - Exclusive package
 - AMG Exclusive package

66 Standard equipment**67 Optional extras****68 Wheels**

- Standard wheels
- Optional wheels
- AMG wheels

70 Genuine accessories

- 72 Services**
 - MercedesCard
 - Mercedes-Benz Financial Services
 - Mercedes-Benz mobility
 - Mercedes-Benz Museum
 - Test drive
 - Interactive Owner's Manual
 - Mobile internet
 - Service packages
 - Accident repairs

74 Dimensions**74 | 77 Paintwork****75 Technical data**

BlueEFFICIENCY – fast forward to tomorrow

Mercedes-Benz is quicker at getting environmentally friendly future technologies to where they matter most: on the road. By the end of 2012, more than 140 Mercedes-Benz models will be available with BlueEFFICIENCY technologies, all of which help you reduce your impact on the environment to a significant degree. Our BlueEFFICIENCY concept comprises innovations for efficient mobility as well as optimised processes all the way along the value chain.

The BlueEFFICIENCY measures – the Mercedes-Benz efficiency package. Comprehensive vehicle optimisations which save fuel and ease the burden on the environment. They involve each model combining the most efficient engine with latest-generation aerodynamic and energy-management measures. Such measures include the ECO start/stop function, which is being made available for a large number of models. The new BlueDIRECT V6 and V8 petrol engines, which feature in several model series, deliver a much higher power output while reducing fuel consumption by up to 25%.

BlueTEC – the clean diesel. A modular emission-control system makes BlueTEC an exceptionally clean diesel technology. As it not only filters 95% of the particulate – the nitrogen oxides are reduced by up to 90% too. What remains is mainly water and nitrogen.

HYBRID – combustion engine and electric motor intelligently combined. The electric motor can support the combustion engine during acceleration (boost effect) or act as a generator which charges the battery during braking (recuperation). The latest-generation hybrid drive system even allows all-electric operation up to 35 km/h as well as efficient, emission-free “gliding”: at speeds below 160 km/h, the combustion engine is shut off automatically on the overrun and the drive system is disengaged. And for the first time, this technology is available with a diesel engine in a premium-class vehicle: the E 300 BlueTEC HYBRID¹.

Innovative drive systems that break new ground: E-CELL and F-CELL. We already have a small series production run of two locally emission-free drive systems on the road: the A-Class E-CELL draws its energy straight from two lithium-ion batteries while the B-Class F-CELL uses hydrogen to generate power for the electric motor. Our vision of emission-free driving is also set to become reality in the luxury class soon in the form of the F 125/ F-CELL Plug-in HYBRID.

But that is not all: under the banner “Design for Environment”, we also look at a vehicle’s entire life cycle and work hard to preserve the environment from the planning stage right through to recycling. What’s more, we are involved in the development of alternative fuels and carry out research in the field of bionics. Further information about our comprehensive measures can be found at: www.mercedes-benz.com/blueefficiency

¹ E-Class E 300 BlueTEC HYBRID Saloon: the vehicle complies with the Euro 5 emission class. Fuel consumption – urban: 4.3–4.2 l/100 km, extra-urban: 4.3–4.2 l/100 km, combined: 4.3–4.2 l/100 km; CO₂ emissions combined: 112–109 g/km. The figures shown were obtained in accordance with the prescribed measuring process (Directive [EC] 715/2007 in the currently applicable version in each case). The figures are not based on an individual model and do not constitute part of the product offer; they are provided solely for purposes of comparison between the different vehicle models

A-Class BlueEFFICIENCY

The new A-Class combines agility and dynamism with efficiency technology and packages of measures aimed at optimising both fuel consumption and emissions.

Where the development of a vehicle is concerned, responsibility for the environment plays a major role. That is why it goes without saying that the new A-Class also has measures for reducing consumption and emissions up

its sleeve. For example with the standard-specification ECO display which tells the driver about the efficiency of their driving style. In this way you can adapt the way in which you drive in order to reduce consumption.

A large number of further carefully coordinated BlueEFFICIENCY measures ensures that no unnecessary burden is placed on the environment:



- 1 Ancillary components controlled to save energy
- 2 Adjustable radiator shutter (A 180 BlueEFFICIENCY) and controlled oil pump
- 3 Particularly efficient alternator
- 4 New engines with direct petrol injection; optimised diesel engines
- 5 Excellent aerodynamics with a c_d value of 0.27
- 6 Standard-specification ECO start/stop function
- 7 Standard-specification ECO display
- 8 Newly developed dual clutch transmission 7G-DCT (as an option)
- 9 Reduced rolling resistance on tyres and wheels
- 10 Intelligent weight reduction through aluminium (front wings, bonnet and other components)

Diesel engines

More economical, cleaner, more powerful: the new A-Class also signals the launch of the current Mercedes-Benz diesel technology. The engines are powerful and quiet. And they impress with their optimised emission and fuel-consumption figures.

4-cylinder in-line engines. The 4-cylinder diesel engines display hallmark Mercedes qualities: they boast a hefty torque and an immediate response, even in the lower engine speed range. At the same time the diesel engines are modest when it comes to fuel consumption, they are low

on emissions, impress with their significantly improved quiet-running characteristics and with their reduced vibrations. The fourth-generation common-rail diesel technology has an injection pressure that has been increased to 1800 bar, optimised combustion chambers

and precise solenoid valve injectors. Improved ignition pressure and a turbocharger with a variable nozzle turbine ensure a high torque in every engine speed range. Intelligently controlled ancillaries contribute towards increasing the efficiency. All the diesel engines have an ECO start/stop function which ensures that the engine is temporarily switched off when the vehicle is at a standstill.

It goes without saying that the diesel engines meet the requirements of the Euro 5 emission class. They are available in different output levels: as the A 180 CDI BlueEFFICIENCY with 80 kW (109 hp) plus a maximum torque of 260 Nm and in the A 200 CDI BlueEFFICIENCY with 1796 cc and 100 kW (136 hp) plus a maximum torque of 300 Nm.

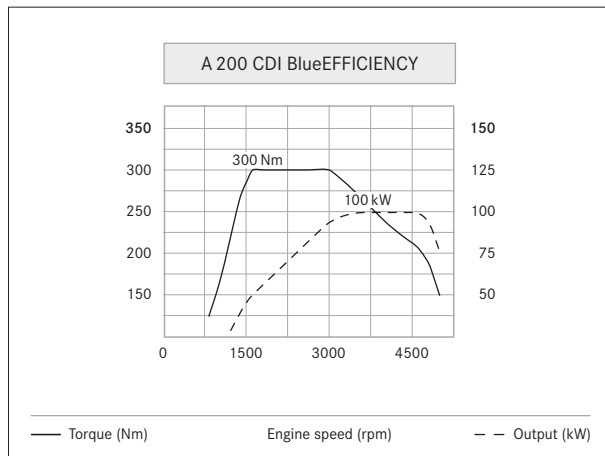

The A 200 CDI BlueEFFICIENCY achieves its peak torque of 300 Nm at between just 1600 and 3000 rpm



The 4-cylinder diesel engine in the A 200 CDI BlueEFFICIENCY combines pulling power with humble consumption and low emissions

Petrol engines

The new petrol engines were developed with the aim of reducing fuel consumption and emissions without compromising on output and ride comfort.

4-cylinder in-line engines. The newly developed 4-cylinder powerplants with a displacement of 1.6/2.0 litres, direct petrol injection, variable valve timing and a turbocharger offer excellent figures when it comes to both torque and power, plus exemplary quiet-running characteristics, not to mention appropriately low fuel consumption and emissions.

The high-pressure direct injection via precise piezo injectors and an enhanced combustion process facilitate virtually total combustion and thus higher efficiency, which means that the fuel can be used more efficiently. The variable valve control results in an optimum cylinder charge level and therefore consumption benefits, which also come courtesy of the lower weight, less internal friction plus ancillaries controlled as required. And last but not least the standard-specification ECO start/stop function raises the efficiency of the engines.

The 4-cylinder petrol engines come with a choice of three power outputs: as the A 180 BlueEFFICIENCY with 1595 cc and 90 kW (122 hp) plus a maximum torque of 200 Nm, in the A 200 BlueEFFICIENCY with 1595 cc and 115 kW (156 hp) plus a maximum torque of 250 Nm,



The newly developed 4-cylinder A 180 BlueEFFICIENCY petrol engine boasts direct injection via piezo injectors and a turbocharger

and in the A 250 BlueEFFICIENCY with 1991 cc and 155 kW (211 hp) plus a maximum torque of 350 Nm. All the petrol engines are low on emissions and thus already comply with the requirements of emission class Euro 6.

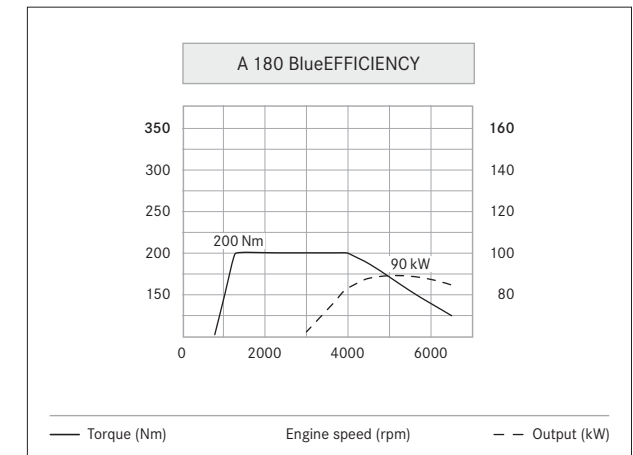

The A 180 BlueEFFICIENCY delivers a peak torque of 200 Nm between 1250 and 4000 rpm

Transmissions

Whether you choose the manual transmission or the optional 7G-DCT dual clutch transmission, whether you prefer an economical or sporty driving style – both transmissions for the new A-Class are optimally matched to the engine. They set benchmarks where shift comfort, efficiency and weight optimisation are concerned.

6-speed manual transmission (standard for A 180 CDI, A 200 CDI, A 180 and A 200). The newly developed 6-speed manual transmission facilitates rapid gear changes through its short shift travel. The standard-specification ECO start/stop function sees to it that the engine is temporarily switched off when the vehicle is standing at traffic lights and in jams, thus that fuel is saved. The standard-fit ECO display in the instrument cluster also supports an efficient driving style.

7-speed dual clutch transmission 7G-DCT (standard for A 180 CDI BlueEFFICIENCY [7G-DCT], A 250 and A 250 Sport). With seven forward gears and one reverse gear the dual clutch transmission combines comfort, sportiness and economy. It comprises two sub-transmissions which each have their own clutch. One of these sub-transmissions supports the “even” gears and the other sub-transmission the “odd” ones. During acceleration or braking the next

highest or next lowest gear is the default setting on the sub-transmission not in use at the time. When changing gear there is then a switchover to the other sub-transmission. This means that the gear change takes place without any delay or loss of traction. Both the clutch actuation and the



The 7G-DCT enables gear shifting with no interruptions in tractive power

gear change occur fully automatically, which is facilitated by particularly smooth gear shifting without any interruption to traction. The preselectable shift programs “Economy”, “Sport” and “Manual” can be set via a switch on the centre console. The programs differ from one another with regard to the shift characteristics and shift speed. In “Sport” mode, changing up a gear takes place at higher engine speeds than is the case in “Economy” mode, changing down a gear earlier. The “Manual” mode, for example, gives sporty drivers the option of performing gear shifting manually via the steering-wheel gearshift paddles included in the package. An ergonomic DIRECT SELECT lever and the cruise control and SPEEDTRONIC functions are already part of the equipment that comes with 7G-DCT.

Chassis & suspension

The new A-Class's driving characteristics can be tuned to individual requirements alongside the standard-specification configuration of the chassis and steering with the optionally available combination of the sports suspension and Direct-Steer system.

Chassis and steering. Thanks to the weight-optimised combination of an enhanced McPherson strut front axle and a completely redesigned four-link rear axle, the all-new chassis ensures driving stability and ride comfort. The standard-fit rack-and-pinion steering with the integral STEER CONTROL steering assistance system for support in critical driving situations stands for precise handling. The power assistance is delivered electromechanically and reduces as the speed increases.

Sports suspension (part of the optional AMG Sport design and equipment line and the optional Dynamic Handling package). The sports suspension blends agility and handling safety with good road roar and tyre vibration characteristics. The springs and dampers have more sportily taut tuning than the standard-specification suspension, whilst the level of the car is 15 mm lower, which reduces rolling movements and increases driving stability.

Direct-Steer system (part of the optional AMG Sport design and equipment line and the optional Dynamic Handling package). The Direct-Steer system complements the suspension with a variable ratio depending on the steering wheel angle, thus ensuring that the steering movements can implement

an even more immediate response on the road. It significantly reduces the steering effort required, in tight bends, for instance, or when parking. The straight-line stability is especially stable at high speeds and the feedback which the driver receives on the driving situation is particularly precise.

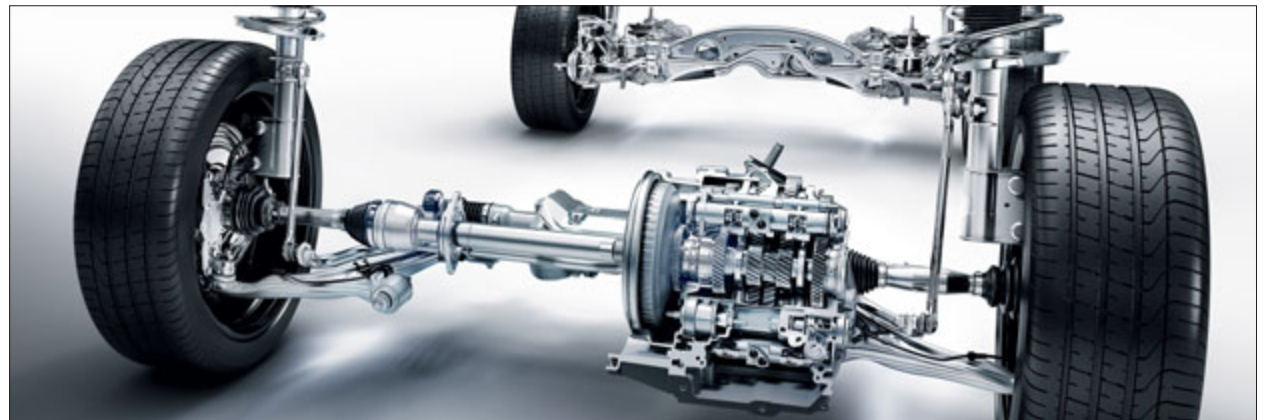

Agility coupled with high comfort

Integral safety concept

The vision of accident-free driving impels us. With our integral safety concept we are coming closer to achieving this goal – this is a holistic approach which can increase safety in every situation.

As the inventor of the motor car we feel a special responsibility for road safety. That's why we became the first car manufacturer to develop an integral safety concept that seamlessly combines active and passive safety measures to provide comprehensive protection. The holistic approach is divided up into four phases and offers safety solutions for every situation. These include systems for safe driving, which help prevent hazards by providing timely alerts and assistance. Our unique PRE-SAFE® system is triggered in response to danger and activates anticipatory measures to protect the occupants. If a collision should occur despite these precautionary measures, other technologies provide the required protection. We have also considered the time immediately after an accident by developing solutions that can prevent serious injury and enable the emergency services to provide rapid assistance. A selection of these technologies for the “Safe driving”, “In the event of danger”, “In an accident” and “After an accident” phases is presented on the pages which follow.

Safe driving: ATTENTION ASSIST (standard). This innovative drowsiness-detection system is especially useful on long trips. At speeds of between 80 and 180 km/h, ATTENTION ASSIST warns the driver as soon as it detects signs of increasing inattention or drowsiness. Sensors analyse driving behaviour and can detect deviations from a previously determined, individual driver profile.



The ATTENTION ASSIST recommends taking a break if it detects signs of driver drowsiness or inattention

Safe driving: COLLISION PREVENTION ASSIST (standard). At speeds of more than 30 km/h the system is able to detect when distances between the vehicle in which it is fitted and those in front or stationary obstacles are too short. If a hazard is detected the driver is given both visual and acoustic warnings. During simultaneous braking the Adaptive Brake Assist can place at the driver's disposal precisely the amount of braking power which is required to prevent an impending collision wherever possible.



The COLLISION PREVENTION ASSIST can recognise a safety margin that is too short and warn the driver

Safe driving: ADAPTIVE BRAKE (standard). A driving dynamics control system with a modular structure. It offers additional safety and comfort functions alongside a base function such as the anti-lock braking system (ABS). The “dry braking” function can remove the film of water from the brake discs in wet conditions – the brake’s response time and therefore the stopping distance can be reduced. “Priming” ensures that the brake pads are placed against the brake discs as soon as the driver takes their foot off the accelerator pedal quickly. The time gained shortens the response time of the brakes. When moving off on an incline unintended rolling back is prevented during the space of time when the foot is moving from the brake pedal to the accelerator. If you actuate the brake pedal a second time whilst the vehicle is stationary, the standard-specification HOLD function keeps the vehicle at a standstill, even if the driver takes their foot away from the brake pedal.

Safe driving: DISTRONIC PLUS (option). The proximity control uses short-range and long-range sensors to maintain the desired safe distance to the vehicle in front. The system operates between 0 and 200 km/h and is also helpful in city traffic or stop-and-go traffic as the sensor can operate in a range of between 0.2 and 200 metres. The system can automatically slow down the vehicle and also accelerate it again.

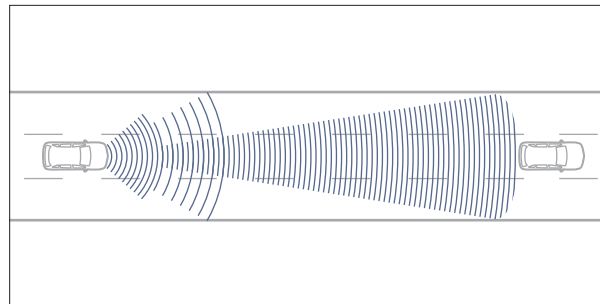

DISTRONIC PLUS supports drivers in automatically keeping their vehicle at a safe distance from the vehicle in front

DISTRONIC PLUS is only available in conjunction with the optional 7-speed dual clutch transmission 7G-DCT.

Safe driving: Lane Keeping Assist/Blind Spot Assist (both part of the optional Lane Tracking package). With the aid of the white lane markings, Lane Keeping Assist is able to detect a line and through gentle steering-wheel vibrations warn the driver if they are in danger of leaving the lane unintentionally. Blind Spot Assist uses two radar sensors to monitor the area which can only be seen poorly by the driver directly alongside and behind the vehicle. If the assistance system detects the danger of an impending collision with another vehicle when changing lanes, the driver can be warned by both visual and acoustic signals if the car is travelling at 30 km/h or more.

Safe driving: Intelligent Light System (option). The system has six functions: country mode, motorway mode, enhanced fog lamp function, cornering light function, active light function plus the Adaptive Highbeam Assist. The latter always provides the best possible low-beam headlamp range. The headlamps can be dimmed automatically as soon as an oncoming vehicle with its lights on is detected. The LED daytime running lamps integrated into the headlamps plus the LED tail lights enhance perceptual safety during the daytime.

In the event of danger: PRE-SAFE® system (option). The preventive occupant protection system PRE-SAFE® is able to recognise critical driving situations in advance and, if necessary, it can activate safety systems which help to reduce the risk of injury to occupants in case they should be needed. This is based on PRE-SAFE® continuously monitoring sensor data from systems like the ESP® and BAS, and can thus, for example, recognise driving situations

such as oversteer/understeer as well as emergency braking. If a critical driving situation is detected, in fractions of seconds the belts on the front seats can be reversibly tensioned and the side windows and optional sliding sunroof automatically closed, so that the belts and airbags are able to deploy their full protective effect should an impact occur.

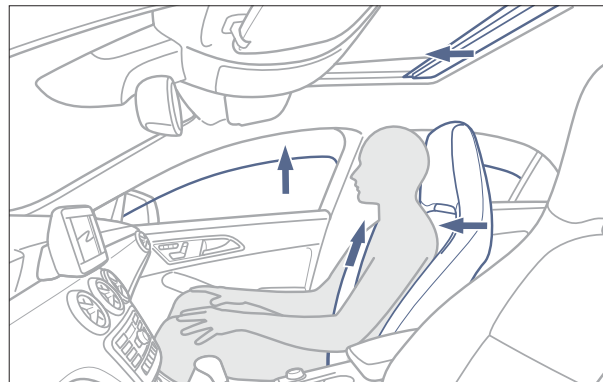

PRE-SAFE® can recognise critical driving situations and initiate preventive measures to protect the occupants

In an accident: active bonnet (standard). It can reduce the risk of injury to pedestrians or cyclists if they are involved in a collision with the bonnet in a speed range between 25 and 55 km/h. To cushion the blow, the bonnet is raised 8.5 centimetres at the rear by means of pyrotechnics.

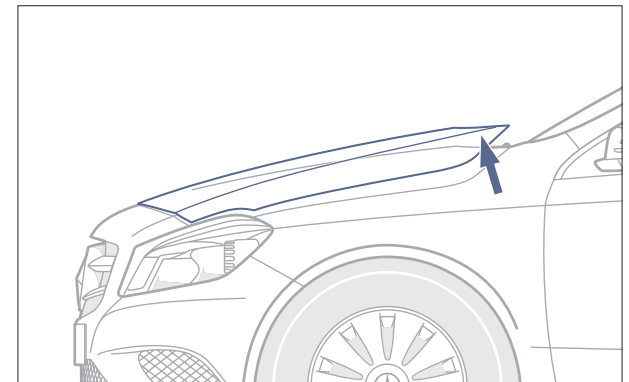

The active bonnet helps to reduce the risk of injury to pedestrians and cyclists in collisions

In an accident: airbags (standard). As well as the robust bodysell structure and the highly stable occupant cell, there are seven standard-fit airbags to provide the best protection possible for the occupants: the front airbags which are deployed in two stages, depending on the severity of the impact and accident characteristics, windowbags

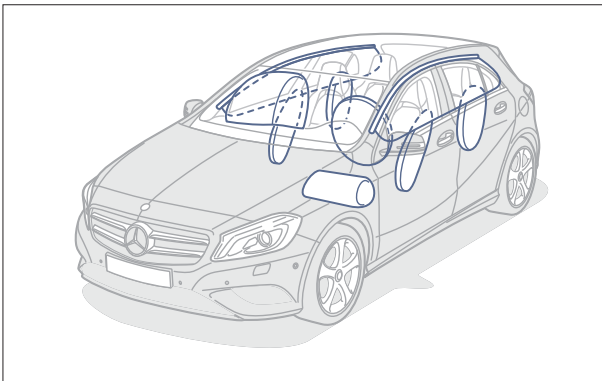

Standard equipment includes windowbags over both rows of seats, airbags and sidebags for the front-seat occupants as well as a driver kneebag

between the A- and C-pillars and sidebags for the driver and front passenger, which serve as thorax/pelvisbags. The kneebag can further reduce the forces exerted on the driver in an accident. Rear sidebags on both sides are available as an option.

After an accident: Mercedes-Benz emergency call system (component of COMAND Online). This system can make an emergency call automatically using a mobile phone which is on standby and connected to the vehicle as soon as the restraint system detects an accident. At the same time, the GPS position data and other data about the vehicle are transmitted to the Mercedes-Benz emergency call centre, after which a voice connection is established. The emergency control system can also be triggered manually.

Measures after an accident. In order to reduce consequential damage and, where necessary, to support the rescue of the occupants, Mercedes-Benz has developed further measures. These include the automatic engine cut-off or the activation of the hazard warning lamps and interior emergency illumination. The central locking also opens automatically and thus makes it easier to open the doors after a front impact. In addition Mercedes-Benz makes Guidelines for Rescue Services available; helpers can download them in different languages all over the world from the internet at www.mercedes-benz.de/rettungsleitfaden. As you can see, at Mercedes-Benz consideration has been given to safety in every situation.

Multimedia systems

The new A-Class offers a full range of entertainment systems, from the Audio 5 USB and the optional Audio 20 CD system with Becker® MAP PILOT to the optional COMAND Online multimedia system.



COMAND Online facilitates user-friendly operation of the main information and communication functions via a single high-resolution colour display with a diagonal of 17.8 cm

COMAND Online (option). The multimedia system boasts a high-resolution 17.8 cm colour display. The system's functions include a radio, speed-sensitive volume control, the MUSIC REGISTER with a 10 GB hard disc and hard-disc navigation. What's more, for three years from the initial registration it also includes free updates for European map data. The DVD drive plays CDs and MP3 content as well as video and audio DVDs. The online function with an integral browser facilitates access to the internet plus various apps such as Google™ Local Search with Street View and Panoramio, weather forecasts and maps, download of Google™ Maps routes, news and Facebook®. A USB and an Aux-in socket, a slot for SD memory cards and a Bluetooth® interface enable connections to external data carriers and a mobile phone. The system is operated via a Controller that can be used intuitively and also via the buttons on the multifunction steering wheel. LINGUATRONIC allows you to operate COMAND Online by voice entry.

Drive kit plus for the iPhone® (option). With the drive kit, including a cradle, an iPhone® 4/4S can be connected to the Audio 5 USB radio. The MB Drive App optimally coordinates the function and design of the iPhone® with the A-Class and impresses with features that are important during a journey: telephoning via the hands-free system, operating the music collection and internet radio plus clever navigation. There is also a Car Finder which takes you back to the parked car time and again. In conjunction



With the drive kit for the iPhone® and the MB Drive App you can already integrate your smart phone's functions with the Audio 5 USB

with Audio 20 CD and COMAND Online the matching drive kit plus for the iPhone® can be selected¹.

Audio 20 CD (option). The multimedia system boasts a TFT display with a 14.7 cm screen diagonal. Thanks to its integral CD drive both MP3 and WMA/AAC files can be played. As an option a 6-disc CD changer can be added to its specification. Audio 20 CD can be conveniently operated via the multifunction steering wheel and the Controller in



The functions provided by the Becker® MAP PILOT are indicated on the Audio 20 CD display and the multifunction display in the instrument cluster

the centre console, and it includes an integral telephone keypad, a Bluetooth® interface with a hands-free function and an Aux-in and USB socket in the stowage compartment on the centre console. Six loudspeakers bring you pristine listening experiences.

Becker® MAP PILOT (option). Fully integral, the new Becker® MAP PILOT with 3D map navigation can be operated using voice entry via the Controller or the multifunction steering wheel. It can be individualised in next to no time by downloading current map data and additional functions.

Harman Kardon® Logic 7® surround sound system (option). With twelve loudspeakers, including a woofer, and a 9-channel DSP amplifier, in conjunction with COMAND Online the 450-watt Dolby Digital 5.1 system ensures an exquisite listening experience. The surround sound playback can be individually tuned to the entire passenger compartment, the front compartment, the centre area or the rear compartment.

¹ Available as a genuine accessory / from the 1st quarter of 2013 as an optional extra

Assistance systems

Alongside numerous safety systems, various convenience assistance systems are also available for the new A-Class for the first time. They can provide the driver with timely warnings of potentially critical situations, helping them avoid dangers.

Reversing camera (option, in conjunction with Audio 20 CD or COMAND Online). The reversing camera with a wide-angle lens and guide lines switches on when reverse gear is engaged and provides additional support for the driver by showing on the screen what is in the area directly behind the vehicle.

Active Parking Assist, including PARKTRONIC (option). With the Active Parking Assist the vehicle looks for a suitable parking space by itself at a speed of up to 35 km/h. As soon as the driver confirms a suggestion for a parking space and engages reverse gear, the Active Parking Assist

automatically parks the car at the press of a button. The driver then only needs to actuate the gearshift, the accelerator and brake pedal. The Active Parking Assist deals with the steering on its own. The system works extremely precisely: for the automatic parking procedure the parking space has to be just 1.30 metres longer than the vehicle.

Speed Limit Assist (included with the optional COMAND Online system). Speed Limit Assist can detect speed-limit signs and display them as symbols on the instrument cluster and in COMAND Online on the navigation screen.

They remain displayed there until the speed restriction is lifted or changed. To this end, a windscreen-mounted camera monitors the area in front of the car on a permanent basis. The camera can filter out round traffic signs, be they speed-limit signs at the side of the road or on a gantry above the road. To detect the signs, the system also draws on the data stored in the navigation system's digital map, thus also enabling it to take account of the vehicle entering or leaving urban areas. Speed Limit Assist is especially helpful on routes with variable speed limits or road works.

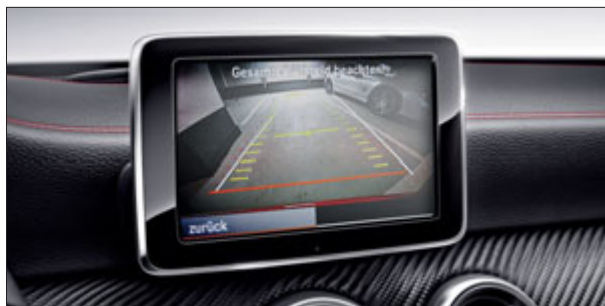

During parking, the COMAND Online central display shows the area behind the car



The display in the instrument cluster gives you a clear picture of the parking manoeuvres



The information from Speed Limit Assist is shown both in the instrument cluster and in the COMAND Online central display

Light and climate control

The optionally available Light and Sight package underlines the safety standards in the new A-Class and stylishly showcases the interior in darkness. The luxury automatic climate control THERMOTRONIC contributes towards a pleasant interior climate.

Light and Sight package (option). The Light and Sight package enhances safety and improves the driver's perception of the traffic – an invaluable benefit in particular during darkness or in poor weather conditions. The package comprises safety-relevant features such as windscreen wipers fitted with a rain sensor and an enlarged washer fluid reservoir, exit and warning lamps for the driver's and front-passenger door, plus a warning and ambient lamp for the tailgate. Quite apart from the safety aspects, the package also increases the high-class appeal of the interior. The integral ambient lighting in the trim on the dashboard and the door shells and door pulls also lends the interior

design of the new A-Class a stylish and exclusive touch. In conjunction with sports seats the opening between the head restraint and the seat backrest is stylishly illuminated. This pleasant overall impression is enhanced by sun visors with an illuminated interior mirror, footwell lighting for the driver and front passenger and in the rear, an illuminated door sill panel, separately controllable reading lamps on both the left- and right-hand side in the rear – and by a downlighter for the rear compartment.

THERMOTRONIC (option). The luxury automatic climate control THERMOTRONIC has separate temperature controls for each side of the interior, allowing the driver and front passenger to travel in comfort at the individual temperature of their choice. At the touch of a button the 2-zone system works fully automatically. THERMOTRONIC keeps the desired temperature constant and also takes exterior factors such as sunlight, air quality and humidity into account via its sensors. This means that there is always a pleasant atmosphere in the new A-Class.



The optionally available Light and Sight package highlights the interior design to practical and stylish effect in equal measure



The optional luxury automatic climate control THERMOTRONIC ensures pleasant interior temperatures

Seats

The newly developed seats are offered in three different variants, meeting individual demands regarding ergonomics, seating comfort and safety.

The standard-specification seats have high backrests, a newly developed head restraint, offer good lateral support and feature black fabric upholstery.

The optionally available saloon seats with three cross-piping elements in the extended shoulder area can be ordered either in fabric or ARTICO man-made leather in the colours black or crystal grey. The optional high-quality sports seats with integral head restraints are part of all the design and equipment lines plus the Exclusive packages. They ensure high levels of seating comfort. Several upholsterys are



The comfortable front seats in the A-Class impress with their ergonomics and wide-ranging adjustment options

available to choose from, including seat covers in ARTICO man-made leather/DINAMICA microfibre or fine leather. Depending on the equipment, drivers can select from the colours black, crystal grey and nut brown.

Seat Comfort package (option). The saloon seats in the Seat Comfort package are characterised by their specific seat cushion design featuring an accentuated shoulder area. They offer the driver and front passenger special comfort on long journeys. The package comprises height adjustment plus seat cushion inclination adjustment for



The new A-Class offers high levels of seating comfort for the rear passengers, too

both front seats. Numerous possibilities for ergonomic individualisation and adjustment to the preferred seat position equal yet more seating comfort.

4-way lumbar support for the driver and front passenger (option). The backrest curvature can be individually adjusted to meet the needs of the driver and front passenger. Two air cushions are integrated in the backrests of both front seats. Via two control valves they can be inflated or deflated as required, facilitating individually tailored support for the lumbar spine. The height of the air cushions is also adjustable.

Electric seat adjustment with Memory function (option). On request the driver's and front-passenger seat are electrically adjustable. The Memory function can save three individual settings for the position of the seats, the head restraint (not in the case of the sports seats) and the exterior mirrors, and they can be called up again at any time.

Roof and space

The new A-Class is impressively spacious for a vehicle in the compact class. The panoramic sliding sunroof lets lots of light in and ensures an even more generous sense of spaciousness. The load compartment offers plenty of room for luggage.

Panoramic sliding sunroof (option). The panoramic sliding sunroof consists of an electrically operated glass sliding roof running on the exterior. The large glass surface offers a generous transparent area and lets lots of light into the interior, giving rise to a particularly light and friendly ambience. A roller blind can be operated electromotively and provides protection against annoying solar radiation. The wind deflectors with a net structure ensure that the noise level stays as low as possible when travelling with the roof open. In conjunction with the optional Light and Sight package the roof closes automatically if it rains.



Thanks to the panoramic sliding sunroof the new A-Class appears even lighter and more spacious through the incidental light

Load compartment. If required the rear seat backrests can be folded in a ratio of 1/3 : 2/3, giving a stowage compartment of up to 1157 litres with a 1.24-metre-long virtually flat load compartment area. When using the A-Class as a 5-seater the load compartment capacity is 341 litres.



The interior can be transformed into a generous load area in just a few simple steps

Stowage Space package (option). The Stowage Space package provides a variety of organisational aids for placing and stowing various items. The specification of the package includes a spectacles compartment in the overhead control panel, a stowage box under the front seats, luggage nets on the driver's and front-passenger seat backrests, in the front-passenger footwell and on the side of the boot as well as beneath the parcel shelf and a practical 12 V socket in the boot.



The practical Stowage Space package ensures that the A-Class offers plenty of room for storing various items

Sports model A 250 Sport – engineered by AMG

The new sports model, the A 250 Sport, impresses with its expressive design and promises added dynamism thanks to an AMG sports suspension that has been developed in-house and features a specific front axle.



An exceptional character and powerful dynamics, combined in the A 250 Sport

The sports model A 250 Sport is available to provide special driving dynamics in the A-Class. It boasts an AMG sports suspension – featuring a specific front axle – developed by the specialists at Mercedes-AMG. The further equipment is based on the AMG Sport design and equipment line, supplemented by other exterior and interior features. These include the striking diamond radiator grille and the characteristic red trim on the AMG front and rear apron plus the red highlight rings on the headlamps. The athletic look is added to by the 5-spoke AMG light-alloy wheels which are painted black with a high-sheen finish and shod with 235/40 R 18 tyres. The perforated brake discs at the front, the red brake callipers at the front and rear plus the sporty engine sound ensure that the A 250 Sport exudes dynamism. The two-pipe exhaust system with oval tailpipe trim in polished stainless steel and the “Sport” badges on the front wings complete the look.

The A 250 Sport delights with characteristic features in the interior, too. This is due in the main to the sports seats with upholstery in ARTICO man-made leather /DINAMICA microfibre and with red contrasting topstitching plus the matching red 3-point seat belts. The hallmark A 250 Sport highlights are also to be found in the red rings on the air outlets and in the red needles on the sporty instrument cluster. The 3-spoke multifunction steering wheel is in nappa leather and also has red contrasting topstitching, as do the armrests in the centre console and the doors. The door centre panels are in black DINAMICA microfibre, and the trim sports a carbon fibre look. The dynamic impression is accentuated by the sports pedals in brushed stainless steel with rubber studs and door sill panels in aluminium. In addition to all this, cord floor mats with black piping, red contrasting topstitching and “Sport” lettering are also part of the sports model’s host of equipment.



The sports seats in ARTICO man-made leather /DINAMICA microfibre upholstery with red contrasting topstitching

Standard equipment

The new A-Class offers hallmark Mercedes comfort as standard.



Sportiness coupled with quality: the new A-Class impresses on the exterior with unusual ideas and painstaking attention to detail. The ex-factory specification includes steel wheels with 10-hole wheel trim and 195/65 R 15 tyres (205/55 R 16 in conjunction with the A 200 CDI BlueEFFICIENCY and A 200 BlueEFFICIENCY) plus a compact rear bumper in the vehicle colour with a black grained diffuser insert. The latest-generation assistance systems such as COLLISION PREVENTION ASSIST and ATTENTION ASSIST are already included as part of the standard specification.







The new A-Class impresses with its high functionality. Its standard-fit equipment includes the air conditioning and Audio 5 USB radio with a twin tuner, three-line display, USB interface and Aux-in socket. The interior scores points with a 3-spoke multifunction steering wheel with 12 function buttons, the multifunction display in the instrument cluster and a hinge-type stowage compartment in the armrest for the driver and front passenger. The standard trim features a honeycomb-look. The seats and door centre panels are covered in black fabric. On request saloon seats with other upholsteries and colours can be selected.



Standard seat model

001 black (fabric)

Saloon seat model (option)

021 black (fabric)

028 crystal grey (fabric)

101 black (ARTICO man-made leather)

108 crystal grey (ARTICO man-made leather)

Trim

honeycomb-look

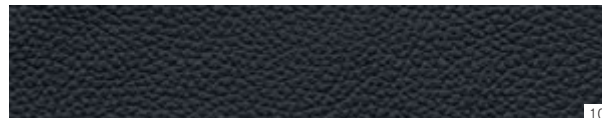

The illustrations show the optionally available drive kit for the iPhone®

Style

The Style design and equipment line lends the new A-Class a confident air.

The specification of the Style design and equipment line includes 10-spoke light-alloy wheels with 205/55 R 16 tyres. A radiator grille with two louvres in the vehicle colour and chrome trim ensures a youthful and autonomous vehicle character.







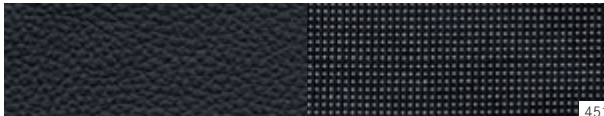

451

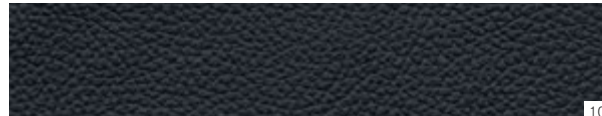

101

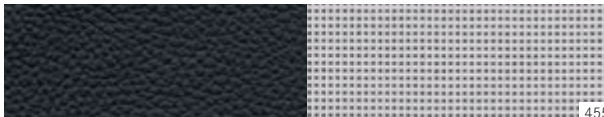

455



108



The optional Style design and equipment line adds individual highlights. The interior boasts sports seats in fabric/ARTICO man-made leather with contrasting topstitching, either in the colours black or black/white, black headlining (grey headlining is optional) plus black matrix-look trim and ventilation outlets with surfaces in silver chrome.

Sports seat model

451 black (ARTICO man-made leather/fabric)

455 black/white (ARTICO man-made leather/fabric)

Saloon seat model

101 black ARTICO man-made leather

108 crystal grey ARTICO man-made leather

Trim

black matrix-look

Urban

The new A-Class becomes even sportier with the Urban design and equipment line.

Available on request, the Urban design and equipment line showcases the new A-Class in a sporty, expressive way and impresses with its 5-twin-spoke light-alloy wheels with 225/45 R 17 tyres, a radiator grille featuring a silver-coloured twin louvre with chrome trim and a two-pipe exhaust system with chrome-look tailpipe trim.









The interior of the Urban design and equipment line displays enhanced sportiness with its sports instrument cluster and sports seats in black or crystal grey, checked-pattern trim, a 3-spoke multifunction steering wheel with perforated leather and contrasting topstitching plus door centre panels and armrests which feature contrasting topstitching all over. In addition to all this, saloon seats with ARTICO man-made leather upholstery can also be selected in black or crystal grey.

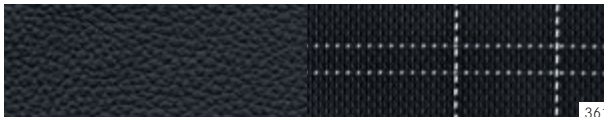

361

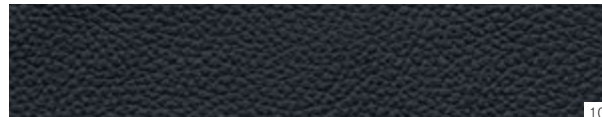

101

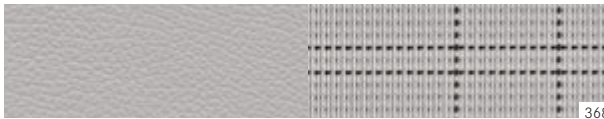

368



108



Sports seat model

361 black (ARTICO man-made leather/fabric)

368 crystal grey (ARTICO man-made leather/fabric)

Saloon seat model

101 black ARTICO man-made leather

108 crystal grey ARTICO man-made leather

Trim

black checked-pattern look

crystal grey checked-pattern look

AMG Sport

The optional AMG Sport design and equipment line gives the new A-Class a powerful appearance.

Dynamism even at a standstill – visible signs of this are the AMG bodystyling, consisting of a front and rear apron plus side skirts, the silver-coloured radiator grille with two louvres and chrome inserts plus the two-pipe exhaust system with oval tailpipe trim in polished stainless steel. Better handling and more fun at the wheel come courtesy of a lowered sports suspension with the Direct-Steer system. The equipment is rounded off by AMG multi-spoke light-alloy wheels, painted titanium grey, with a high-sheen finish and shod with 225/40 R 18 tyres, plus perforated brake discs at the front and also front brake callipers with Mercedes-Benz lettering.









Characteristic features of the AMG Sport design and equipment line's interior are seats in ARTICO man-made leather/DINAMICA microfibre with red contrasting topstitching, door centre panels in black DINAMICA microfibre and black headlining. There is also a 3-spoke multifunction sports steering wheel – with a flattened bottom section – featuring nappa leather with red contrasting topstitching and perforation in the area of grip, the sports instrument cluster with red needles, carbon fibre look trim plus AMG floor mats in cord with black piping and red contrasting topstitching. The hallmark red contrasting topstitching is also on the shift lever in nappa leather as well as on the armrests in the centre console and the doors. The crowning glory comes in the form of the sports pedals in brushed aluminium with rubber studs and the door sill panels in aluminium.

The appointments in the illustration on the right show the extended AMG Exclusive package, which is based on the AMG Sport design and equipment line.

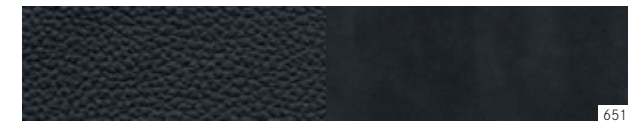

Sports seat model

651 black (ARTICO man-made leather/DINAMICA microfibre)

Trim

carbon fibre look



Night package

Extravagant design ideas and special standards come together in the optionally available Night package. It comprises a high-gloss black radiator grille featuring a 2-louvre look with chrome trim, black exterior mirrors, a waistline trim strip in high-gloss black, 5-twin-spoke light-alloy wheels painted in black with a high-sheen finish and 225/40 R 18 tyres plus heat-insulating dark-tinted glass at the rear and rear side windows. The Night package is designed as a purely exterior package for further individualisation, and is based on one of the three design and equipment lines Style, Urban or AMG Sport. In conjunction with the AMG Sport design and equipment line the Night package comprises 5-twin-spoke AMG light-alloy wheels painted in black, with a high-sheen finish and 225/40 R 18 tyres.



Exclusive package and AMG Exclusive package



The optional Exclusive package meets the requirements of those looking for a particularly high-quality interior at luxury-segment level. It beguiles with its hallmark Mercedes luxury such as heated sports seats with a 4-way lumbar support for the driver and front passenger, plus black, crystal grey or nut brown leather upholstery. The steering wheel and selector lever are also trimmed with leather, the door centre panels, the armrest and the dashboard are colour-coordinated with them and adorned with ARTICO man-made leather. Floor mats in cord round off the appointments.

Based on the AMG Sport design and equipment line, an extended AMG Exclusive package featuring two-tone upholstery in black RED CUT leather with red contrasting topstitching is available. (Please see the illustration on page 61.)



801



811



808

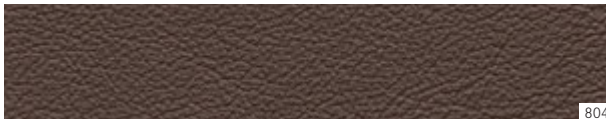

804



Exclusive package

Sports seat model

801 black (leather)

808 crystal grey (leather)

804 nut brown (leather)

Trim

black (leather look)

crystal grey (leather look)

nut brown (leather look)

AMG Exclusive package

Sports seat model

811 black RED CUT (leather)

Trim

carbon fibre look

Standard equipment | Selection



3-spoke multifunction steering wheel with 12 function buttons



Audio 5 USB



Air conditioning



Armrest with stowage compartment



Power windows, 4



Automatic headlamp activation

Optional extras | Selection



Bi-xenon headlamps



Panoramic sliding sunroof



Trailer coupling



Illuminated door sill panels in the Light and Sight package



Audio 20 CD with Becker® MAP PILOT



THERMOTRONIC

Wheels



Steel wheel with 10-hole wheel trim and 195/65 R 15 tyres (standard, not available for A 200 CDI, A 200, A 250 or A 250 Sport, Code R00)



Steel wheel with 10-hole wheel trim and 205/55 R 16 tyres (standard in conjunction with A 200 CDI and A 200, Code 643)



10-hole light-alloy wheel and 205/55 R 16 tyres (standard in conjunction with Style, not in conjunction with Urban or AMG Sport, Code 55R)



10-spoke light-alloy wheel and 205/50 R 17 tyres (option, Code 25R)



10-spoke light-alloy wheel and 225/45 R 17 tyres (standard for A 250, not in conjunction with AMG Sport, Code R43)



5-twin-spoke light-alloy wheel and 225/45 R 17 tyres (standard in conjunction with Urban, not in conjunction with AMG Sport, Code R11)



5-twin-spoke light-alloy wheel, painted tremolite grey and with 225/45 R 17 tyres (option, not in conjunction with AMG Sport, Code 44R)



5-twin-spoke light-alloy wheel, painted himalayas grey, with a high-sheen finish and 225/45 R 17 tyres (option, not in conjunction with AMG Sport, Code R48)



5-twin-spoke light-alloy wheel, painted black, with a high-sheen finish and 225/40 R 18 tyres (option, not available for AMG Sport or A 250 Sport, Code R38)



5-twin-spoke light-alloy wheel, painted matt black, with a high-sheen finish and 225/40 R 18 tyres (standard for Night package, not available for AMG Sport or A 250 Sport, Code R10)



Multi-spoke AMG light-alloy wheel, painted titanium grey, with a high-sheen finish and 225/40 R 18 tyres (standard in conjunction with AMG Sport, Code 791)



5-twin-spoke AMG light-alloy wheel, painted black, with a high-sheen finish and 225/40 R 18 tyres (standard for Night package in conjunction with AMG Sport, option, not available for A 250 Sport, Code 781)



5-twin-spoke AMG light-alloy wheel, painted titanium grey, with a high-sheen finish and 225/40 R 18 tyres (option, not available for A 250 Sport, Code 794)



Multi-spoke AMG light-alloy wheel, painted black, rim flange with a high-sheen finish and 225/40 R 18 tyres (option not available for A 250 Sport, Code 646)



5-spoke AMG light-alloy wheel, painted black, with a high-sheen finish and 235/40 R 18 tyres (standard for A 250 Sport, Code 774)

Genuine accessories

Practical, versatile, progressive – there's not much the new A-Class can't do. And there are always the genuine accessories from Mercedes-Benz.

With the genuine accessories range you can either make your A-Class more practical, more comfortable, or more multimedial. Or all of the above.

With the drive kit plus for the iPhone® your iPhone® 4/4S is extensively integrated into the A-Class. The matching



Practical, aerodynamic, elegant: the roof box offers much more than just stowage space

Digital DriveStyle App is available free of charge in the iTunes® App Store. This means that with the Audio 20 CD and COMAND Online you have access to the fundamental contents of your iPhone®, which are shown in the vehicle display and can be easily and safely operated via the Controller on the centre armrest.

With the integration of the iPhone® into the vehicle and the revolutionary user interface design you can seamlessly continue your digital lifestyle in the vehicle. This means that, amongst other things, you have access to the progressive navigation solution from Garmin® with internet-based real-time traffic information, an online POI search and 3D map display. A further highlight is the personalised internet radio from AUPEO! Personal Radio, a customised music program. Following access via genre or artist, tracks matching your personal taste are played. A social/interactive experience is also possible with sharing, posting via Facebook®, Twitter® and Glympse™ and the integration of music plus other contents from the social networks including a text-to-speech

function. In addition, an intuitive Car Finder automatically stores the location of the vehicle. Thanks to pedestrian navigation this enables the vehicle to be found again easily.

A further practical feature is the 400 roof box. It has the incredible capacity of around 400 litres, can take loads of up to 75 kg and boasts handle strips on both sides for better handling. In order to make optimum use of the stowage space in the roof box there are items such as the suitably dimensioned luggage set, comprising three bags plus a ski bag for a maximum of two pairs of skis.

And we can top this for the more sporty drivers in the form of a dynamic roof spoiler and a rear apron trim with a diffuser-look. This also lends the new A-Class a racy touch in visual terms.

See our range of genuine accessories for yourself – just take a look at our brochure or pay a visit to your authorised Mercedes-Benz dealer.



With the drive kit plus for the iPhone® and the Digital DriveStyle App the smart phone is extensively integrated in the new A-Class

Services

MercedesCard is an internationally accepted means of payment. Further benefits are available to provide you with peace of mind, such as Mercedes-Benz insurance packages and the exclusive MercedesCard insurance package. What's more, the Mercedes-Benz Magazine will inspire you with fascinating features and reports. Further details are available from your authorised Mercedes-Benz dealer.

Mercedes-Benz Financial Services. Mercedes-Benz stands for quality, innovation and safety – and the same applies to Mercedes-Benz Financial Services. Our innovative leasing and financing products are tailored to your financial needs and means, making it easy for you to secure the keys to your dream car. Once you are on the road, our insurance products offer you comprehensive protection on every trip. Finally, our service products ensure that your car is always in tip-top condition while keeping costs transparent and easily manageable. For a detailed quotation, please contact your authorised Mercedes-Benz dealer, who will be glad to go through the latest financial services and terms and conditions with you.

Mercedes-Benz mobility. Your new car comes complete with the promise of feeling safe on the road, but if you should ever need assistance, then Mercedes-Benz Service24h is there to help. Just call the freephone service hotline on 00800 1 777 7777¹. The newly integrated telematics service, Mercedes-Benz Contact², is even more customer friendly: a touch of a button is all it takes to contact the Mercedes-Benz customer centre. If you wish, the relevant vehicle and position-related data can be transmitted at the same time, thereby allowing the centre to react quickly and provide rapid on-the-spot assistance. Also standard with your new car at no extra charge is the Mercedes-Benz Mobilo³ mobility package. Whether you have lost your key, had a breakdown which cannot be repaired immediately or suffered damage to the vehicle due to an accident or vandalism, Mobilo is there to help you reach your destination – anywhere in Europe.

Mercedes-Benz Museum. Experience more than 125 years of automotive history in a unique setting. Over 1500 exhibits on nine levels give you an insight into the tradition and powers of innovation of the Mercedes-Benz brand in Stuttgart. We look forward to your visit – online, too: www.mercedes-benz-classic.com/museum



¹ Alternative: +49 69 95 30 72 77. The only charge incurred is the cost of the mobile phone call to the landline network ² Requires a factory-fitted radio, connected to an operational mobile phone. The only charge incurred is the cost of the mobile phone call to the landline network

³ Once the warranty for breakdowns and policy benefits has expired (four years), Mobilo can be extended in periods of one year for a maximum of 30 years, provided that regular maintenance is carried out by your Mercedes-Benz service partner

Test drive. The unique feeling of driving a Mercedes cannot be put into words. We'd like to invite you to experience it for yourself – take a test drive and find out first hand how it feels to drive your dream car. Your nearest authorised Mercedes-Benz dealer is looking forward to your call.

Interactive Owner's Manual. The website also offers an interactive tour, enabling you to acquaint yourself with your dream car. You can view key functions in detail, gain an insight into the car's inner workings or look at the benefits of each model. For further details, go to www.mercedes-benz.de/owners-manual

Mobile internet. You can also find the entire world of Mercedes-Benz on your mobile end device at any time. As well as an overview of all the passenger car models, there are insights into the whole brand world along with a wealth of entertainment offers and direct links to our range of services at www.mercedes.mobi

Mercedes-Benz service contracts. Vehicle-specific service contracts allow you to put together an individual

package for your Mercedes: for a small monthly premium the Excellent service contract covers all service jobs including maintenance, wear and repairs – for up to five years. Simply present your service card to avoid any financial surprises. And you can be sure that your Mercedes will remain on top form for a long time to come. The Advance service contract offers a warranty extension. You are protected against unexpected repair costs even after the manufacturer's warranty or the Excellent service contract has expired – for up to ten years.



Accident repairs. Should the worst happen and you find yourself in need of repairs, with Mercedes-Benz accident repairs you will receive the best possible assistance for your vehicle and ensure that its high-quality safety features are properly maintained. Whether you need paint, body or glass repair work carried out, the highly trained specialists at your Mercedes-Benz service partner will repair your Mercedes-Benz and get you quickly back on the road again. Further information is available from your authorised Mercedes-Benz dealer.



Dimensions

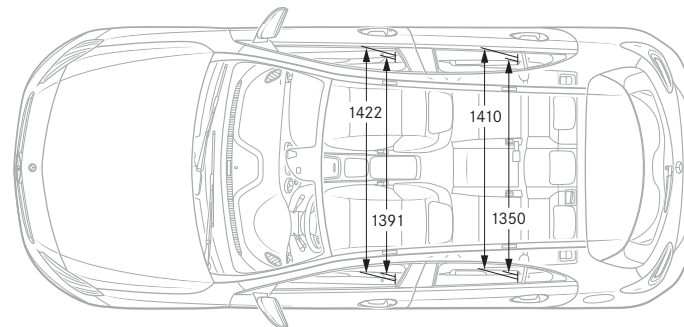
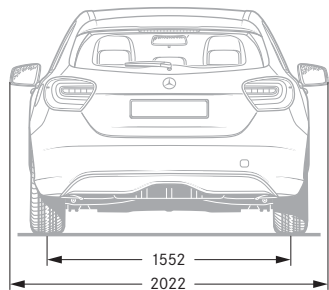
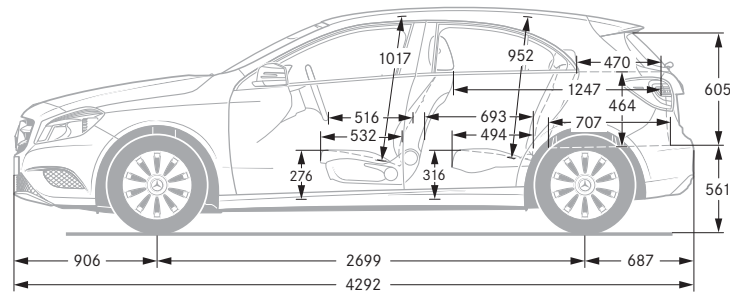
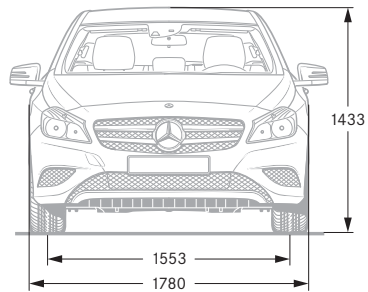

Paintwork

Non-metallic paints (standard)

- 589 jupiter red
- 650 cirrus white
- 696 night black

Metallic paints (option)

- 162 south sea blue
- 191 cosmos black
- 761 polar silver
- 787 mountain grey
- 893 monolith grey
- 894 universe blue
- 895 canyon beige

Special paint (option)

- 662 designo magno mountain grey¹

¹ In all likelihood available from January 2013

Technical data

No. of cylinders/arrangement
Total displacement in cc
Rated output ² in kW (hp) at rpm
Rated torque ² in Nm at rpm
Transmission
Acceleration from 0 to 100 km/h (s) (automatic transmission)
Top speed, approx. in km/h
Tyre size, front
Tyre size, rear
Fuel
Fuel consumption ³ in l/100 km
Urban (automatic transmission)
Extra-urban (automatic transmission)
Combined (automatic transmission)
CO ₂ emissions ³ in g/km combined (automatic transmission)
Emission class
Tank capacity, incl. reserve, approx. in l
Boot capacity
Turning circle diameter in m
Kerb weight/payload ⁴ in kg (automatic transmission)
Perm. GVW in kg (automatic transmission)

Diesel engines

A 180 CDI BlueEFFICIENCY	A 180 CDI BlueEFFICIENCY (7G-DCT)	A 200 CDI BlueEFFICIENCY
4/in-line	4/in-line	4/in-line
1461	1796	1796
80 (109)/4000	80 (109)/3200-4600	100 (136)/3600-4400
260/1750-2500	250/1400-2800	300/1600-3000
6-speed manual	7G-DCT	6-speed manual (7G-DCT)
11.3	(10.6)	9.3 (9.2)
190	190	210
195/65 R 15	195/65 R 15	205/55 R 16
195/65 R 15	195/65 R 15	205/55 R 16
Diesel	Diesel	Diesel
4.7-4.5	(5.0-4.8)	5.6-5.3 (5.0-4.8)
3.6-3.3	(4.1-3.8)	4.0-3.7 (4.1-3.8)
4.0-3.8	(4.4-4.1)	4.6-4.3 (4.4-4.1)
105-98	(116-109)	121-111 (116-109)
Euro 5	Euro 5	Euro 5
50/6.0	50/6.0	50/6.0
341-1157	341-1157	341-1157
11.00	11.00	11.00
1395/565	(1475/525)	1445/565 (1475/525)
1960	(2000)	2010 (2000)

¹ In all likelihood available from the 4th quarter of 2012 ² Figures in accordance with Directive 80/1269/EEC in the currently applicable version ³ The figures shown were obtained in accordance with the prescribed measuring process (Directive [EC] 715/2007 in the currently applicable version).
The figures are not based on an individual model and do not constitute part of the product offer; they are provided solely for purposes of comparison between different vehicle models

	Petrol engines			
	A 180	A 200	A 250	A 250 Sport ¹
	BlueEFFICIENCY	BlueEFFICIENCY	BlueEFFICIENCY	
No. of cylinders/arrangement	4/in-line	4/in-line	4/in-line	4/in-line
Total displacement in cc	1595	1595	1991	1991
Rated output ² in kW (hp) at rpm	90 (122)/5000	115 (156)/5300	155 (211)/5500	155 (211)/5500
Rated torque ² in Nm at rpm	200/1250-4000	250/1250-4000	350/1200-4000	350/1200-4000
Transmission	6-speed manual (7G-DCT)	6-speed manual (7G-DCT)	(7G-DCT)	(7G-DCT)
Acceleration from 0 to 100 km/h in s (automatic transmission)	9.2 (9.1)	8.4 (8.3)	(6.6)	(6.6)
Top speed, approx. in km/h	202	224	240	240
Tyre size, front	195/65 R 15	205/55 R 16	225/45 R 17	235/40 R 18
Tyre size, rear	195/65 R 15	205/55 R 16	225/45 R 17	235/40 R 18
Fuel	Premium petrol	Premium petrol	Premium petrol	Premium petrol
Top speed, approx. in km/h				
Urban (automatic transmission)	7.7-7.5 (7.3-7.1)	7.7-7.5 (7.3-7.1)	(8.4-8.3)	(8.4-8.4)
Extra-urban (automatic transmission)	4.7-4.3 (4.8-4.5)	4.8-4.4 (4.8-4.5)	(5.0-4.9)	(5.1-5.1)
Combined (automatic transmission)	5.8-5.5 (5.7-5.4)	5.8-5.5 (5.7-5.4)	(6.2-6.1)	(6.4-6.4)
CO ₂ emissions ³ in g/km combined (automatic transmission)	135-128 (133-127)	136-129 (133-127)	(145-143)	(148-148)
Emission class	Euro 6	Euro 6	Euro 6	Euro 6
Tank capacity, incl. reserve, approx. in l	50/6.0	50/6.0	50/6.0	50/6.0
Boot capacity	341-1157	341-1157	341-1157	341-1157
Turning circle diameter in m	11.00	11.00	11.00	11.00
Kerb weight/payload ⁴ in kg (automatic transmission)	1370/565 (1395/525)	1370/565 (1395/525)	(1445/525)	(1445/525)
Perm. GVW in kg (automatic transmission)	1935 (1920)	1935 (1920)	(1970)	(1970)

¹ Figures according to Directive 92/21/EC, version 95/48/EC (kerb weight with fuel tank 90% full, driver, 68 kg, and luggage, 7 kg) for standard-specification vehicles. Optional extras and accessories will generally increase this figure and reduce the payload capacity accordingly. Further technical data can be found at www.mercedes-benz.com

Non-metallic paints

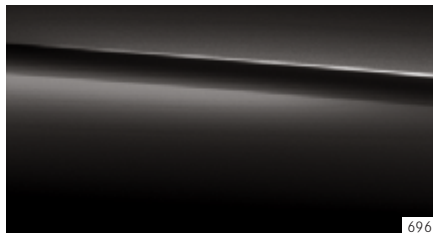
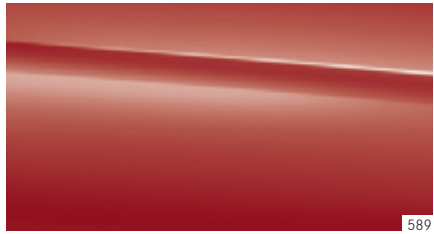

Metallic paints

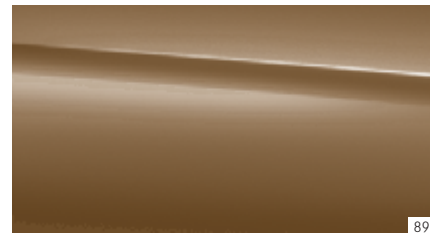
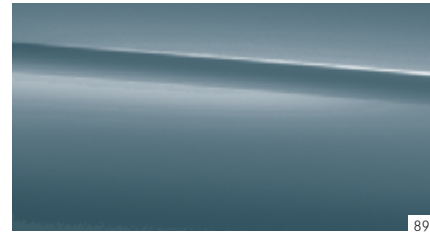
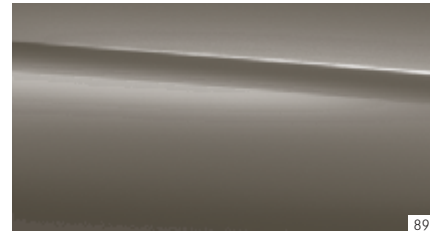
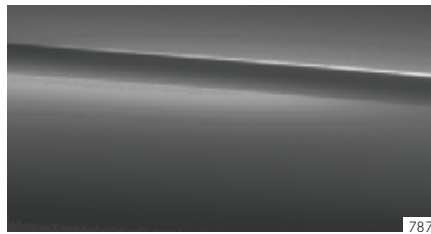
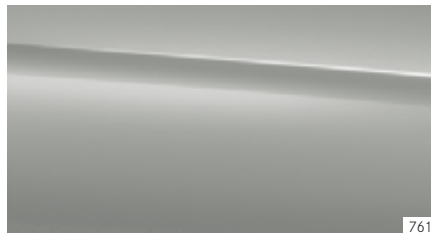
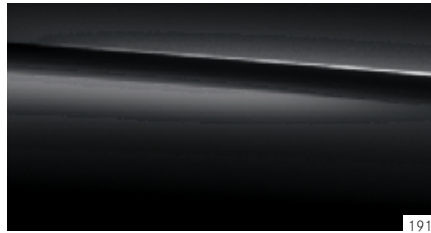

Special paint

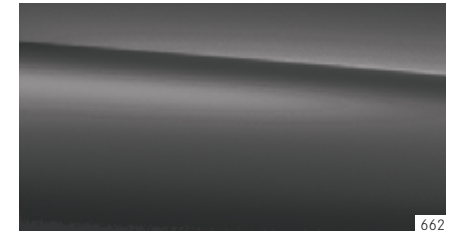

Take-back of end-of-life vehicles. You can return your A-Class to us for environment-friendly disposal in accordance with the European Union (EU) End-Of-Life Vehicle Directive. But that day lies a long way off.

A network of vehicle take-back depots and dismantlers has been established to make it as easy as possible for you to return your vehicle. You can leave it at any of these points free of charge and, by doing so, make an important contribution to completing the recycling process and conserving resources.

For further information about the recycling and disposal of end-of-life vehicles, and the take-back conditions, please visit the national Mercedes-Benz website.

Please note: changes may have been made to the product since this brochure went to press (18.05.2012). The manufacturer reserves the right to make changes to the design, form, colour and specification during the delivery period, provided these changes, while taking into account the interests of the vendor, can be deemed reasonable with respect to the purchaser. Where the vendor or the manufacturer uses symbols or numbers to describe an order or the subject of an order, no rights may be derived solely from these. The illustrations may show accessories and items of optional equipment which are not part of standard specification. Colours may differ slightly from those shown in the brochure, owing to the limitations of the printing process. This brochure is distributed internationally. It provides a general indication of the range of models, features, optional extras and colours available in various countries. Some of the models, features, optional extras and colours shown may not be available in your country or may only be available in a different specification. Additionally some models, features, optional extras and colours may only be available in combination with others. For current and more specific information in relation to the range of models, features, optional extras and colours available in your country, and their pricing, you should contact your nearest authorised Mercedes-Benz Passenger Car Dealer.

www.mercedes-benz.com