

The SL-Class.



Mercedes-Benz



This Brochure is prepared by Daimler AG and it predominantly reflects the capabilities and performance of vehicles sold in Europe.

Some characteristics, capabilities, performance features and optional extras (e.g. towing systems) may not be available or may not apply in Australia under Australian conditions. The information in this Brochure is therefore indicative, illustrative and provided only for guidance and should not be relied on. To obtain current and accurate information on a vehicle and any options applicable to Australia, contact your local authorised Mercedes-Benz dealer.



# The SL-Class. Athlete. Aesthete.

Opposites attract – and nowhere are they more attractive than in the SL, whose ability to reconcile extremes is unrivalled. It embodies both a legendary sports car tradition and trendsetting innovations. It is a car that looks to the future while recalling the past. This is true not only of its aesthetically appealing design with its elegant acknowledgements of its proud history, but also of its exemplary safety concept featuring assistance and protection systems. The highly advanced chassis systems allow the handling to be adjusted between dynamism and comfort, as required by the driver. Efficient engines, a luxurious interior and perfection down to the smallest detail underline the exceptional status of this dream sports car. Thanks to the optional panoramic roof, the occupants can enjoy the visual dimension even when the roof is closed. And with Frontbass, the SL boasts a world first which redefines high-end acoustics. In this way, sportiness and comfort combine to create a uniquely refined driving experience. The SL is simply both: an athlete and an aesthete.

**Guide to the vehicles shown here:**

**2 | Mercedes-Benz SL 500**

**designo cerussite grey magno**

AMG Line, AMG 5-spoke light-alloy wheels, Exclusive nappa leather in black, light longitudinal-grain aluminium trim

**10 | Mercedes-Benz SL 400**

**designo hyacinth red metallic**

5-twin-spoke light-alloy wheels, nappa leather in porcelain, satin-finish light brown poplar trim

**18 | Mercedes-Benz SL 63 AMG**

**designo allanite grey magno**

AMG 10-spoke light-alloy wheels, Exclusive nappa leather in black, light longitudinal-grain aluminium trim

**Vision.**

24 | Moving innovation

**Drive system and chassis.**

26 | Petrol engines

28 | Transmissions

29 | Chassis and suspension

**Safety.**

30 | Integral safety concept

**Comfort.**

32 | Multimedia systems

33 | Assistance systems

34 | Open-air comfort

36 | Roof and space

38 | Climate control and light

40 | Seats

**AMG.**

42 | SL 63 AMG

44 | SL 63 AMG technical details

46 | SL 65 AMG

48 | SL 65 AMG technical details

50 | AMG Performance Studio

**Equipment & appointments.**

52 | Standard equipment

53 | Optional extras

54 | AMG Line

58 | designo

60 | Upholstery and trim

66 | Wheels

68 | Genuine Accessories

**70 | Services.**

**Facts and colours.**

72 | Dimensions

72 | Paintwork

73 | Technical data

The illustrations may show accessories and optional extras which are not part of standard specification.





## Forged in a fire that never goes out: passion.

Over sixty years ago a car that would go on to receive the title “Sports Car of the Century” was created. It was the legendary 300 SL, the model that established a unique tradition of sports cars. Today’s SL generation is systematically building on and extending this tradition. The legend lives on.

# The fine art of flying without taking off.

SL drivers are in an enviable position: the breathtaking feeling of sitting at the wheel of an SL is impossible to express in mere words. So let's look at the underlying technology: the body is a triumph of aluminium engineering, the chassis a gamechanger which reconciles comfort and dynamism to perfection. And the extreme roadholding is like nothing you have ever experienced. But one thing remains resolutely familiar: the outstanding quality of Mercedes-Benz technology. → Page 29









# Proves that you have no need to prove anything any more.

There is no greater challenge than that of repeatedly surpassing oneself. But few have risen to it more successfully over the years than the SL. Its BlueDIRECT engines are more powerful – and economical – than ever, thereby proving that it is possible to deliver higher performance and efficiency with a smaller displacement. The SL just keeps on surpassing itself. Even at the filling station. → Page 26, 27





# Nothing less than luxury.

The SL embodies a design philosophy which rejects the everyday in favour of the exclusive. There are no bass loudspeakers to be found in the doors, for example. Instead, the sound is emitted from the side members of the front section of the car. The vehicle body itself becomes a resonance cavity – an innovative and acoustically impressive design solution.

→ Page 32





## Wide awake, yet still a dream.

Although an SL is a dream to drive and extremely comfortable, it is always alert and designed to ensure that you are, too. A range of intelligently coordinated safety components, which can be extended optionally with practically every driving assistance system currently available, makes it one of the world's safest cars. Which is, after all, what one would expect from the SL, the Mercedes among roadsters.

→ Page 30, 31, 33







# On course for euphoria.

Open up the vario-roof, open up the throttle and feel the endorphins kick in. The supremely confident cornering performance of the SL will have the adrenaline surging through your veins. Even when stationary it has the power to move you.

# Mastered. Not tamed.

When you're always out in front, it's important to look good from the rear, too. But the SL doesn't just impress with breathtaking acceleration. Its 4-piston fixed-calliper front brakes have real bite which can deliver equally reassuring deceleration. Which is good to know, if your enthusiasm at the wheel should ever get the better of you.





The image shows the interior of a Mercedes-Benz SL, focusing on the front and rear seats upholstered in light-colored leather with dark stitching. The car is parked on a rooftop or elevated platform, with a cityscape visible in the background under a cloudy sky. The interior features a combination of light and dark leather, with a black door panel and a wooden trim element on the door. The overall aesthetic is clean, modern, and luxurious.

One of the most impressive features of the SL is usually out of sight when the sun is shining. The light vario-roof with optional MAGIC SKY CONTROL folds away beneath the taut lines of the tail end in a matter of seconds. Once stowed, it reveals a cockpit that complements the stylish exterior to perfection. As an option, it can be enhanced with exclusive, elegant leather upholstery which reflects not just the sun, but your good taste, too. → Page 34-37







# The best. And then some.

Good, better, best. According to the grammar books, that's as far as it goes. We beg to differ. Take the SL 63 AMG, for example. First among equals, it features a unique combination of outstanding dynamism and maximum efficiency. Not to mention the world's torquiest V8 twin-turbocharged engine to be found in a series-production vehicle. → Page 42–45







The sky's the limit.  
Even with the roof closed.

Car enthusiasts the world over are united by the pursuit of certain eternal questions. How can the best be made even better? When can a car's performance be judged to be perfect? Who pushes the limits to the limit? There can only be one answer: the SL 63 AMG.

A silver Jaguar driving through a tunnel, with motion blur on the road and other vehicles in the distance. The car is in the foreground on the right, and the tunnel recedes into the distance on the left. The scene is lit with dramatic blue and white lights, creating a sense of speed and motion.

Who says “transport of delight”  
is just a figure of speech?



# What makes a car a Mercedes?

Deep-rooted traditions: in our case, it is innovative traditions that run deep. We've gone along previously untravelled roads. Setting milestone after milestone. The first car with a crumple zone, the first ABS, the first diesel car. The first car. And whilst it's nice to look back, we'd much rather look forward.

**Mercedes me** – welcome to a world that revolves entirely around you. We focus on people. No more so than when we developed a new platform for you to keep in close contact with Mercedes-Benz. With services that are tailored to your needs. “connect me” connects the vehicle to your world of experience, to everything that is important to you. “move me” provides new mobility solutions. And “inspire me” gives you an exclusive insight into the future of mobility. Your gateway to a fascinating world: [www.mercedes.me](http://www.mercedes.me)



**Mercedes-Benz Intelligent Drive** – on the road to accident-free driving. We develop intelligent technologies that actively assist the driver and make driving tangibly easier. Valuable assistance systems are already available in your Mercedes-Benz: they help to maintain the distance to the vehicle in front automatically, brake the car when necessary and warn against imminent rear-end collisions or vehicles in the blind spot. The sensors of the driving assistance and safety systems are linked intelligently. Potential hazardous situations are detected earlier than ever and consequently avoided with increasing regularity. Discover the fascinating world of Mercedes-Benz Intelligent Drive at [www.mercedes-benz-intelligent-drive.com](http://www.mercedes-benz-intelligent-drive.com)

**BlueEFFICIENCY** – our vision of emission-free driving. Sustainability is a big word. And it's a prime consideration in absolutely everything we do. From minimising the environmental impact of our production operations to alternative drive concepts.

The aims are ambitious, as you can see. But what could be better than seeing these aims achieved whilst on a long drive in a Mercedes?

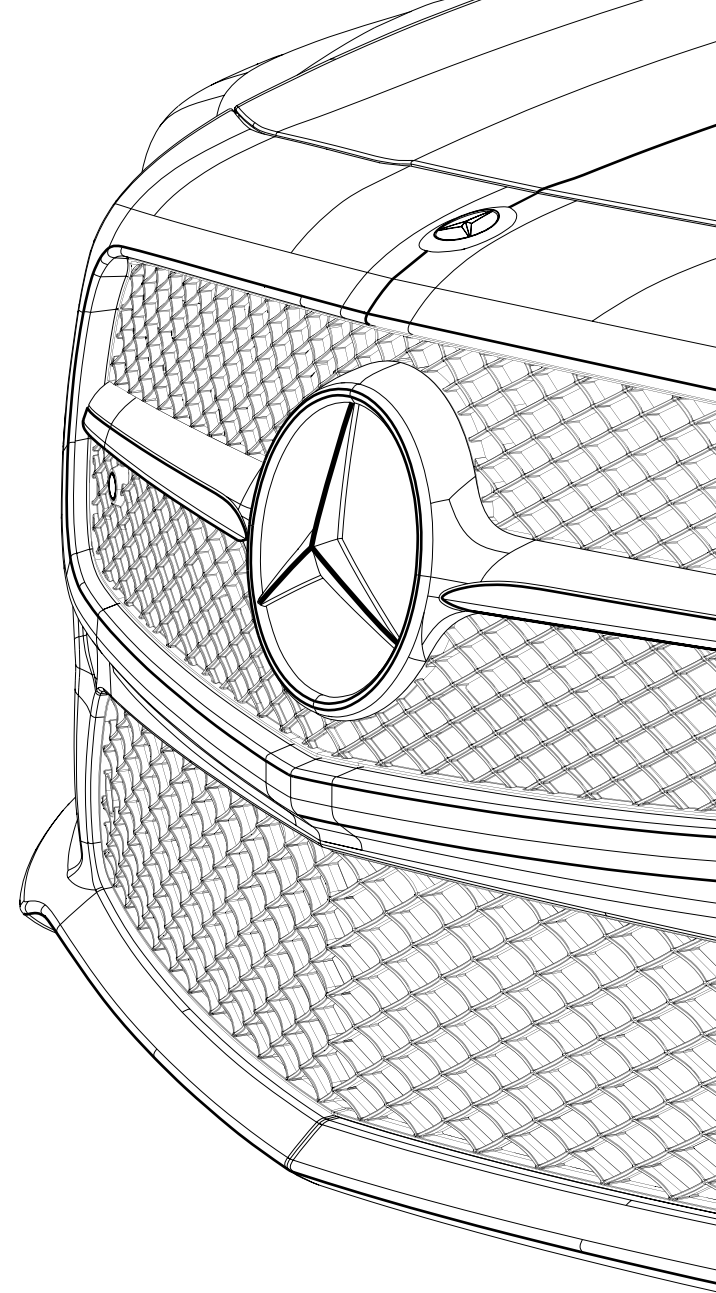

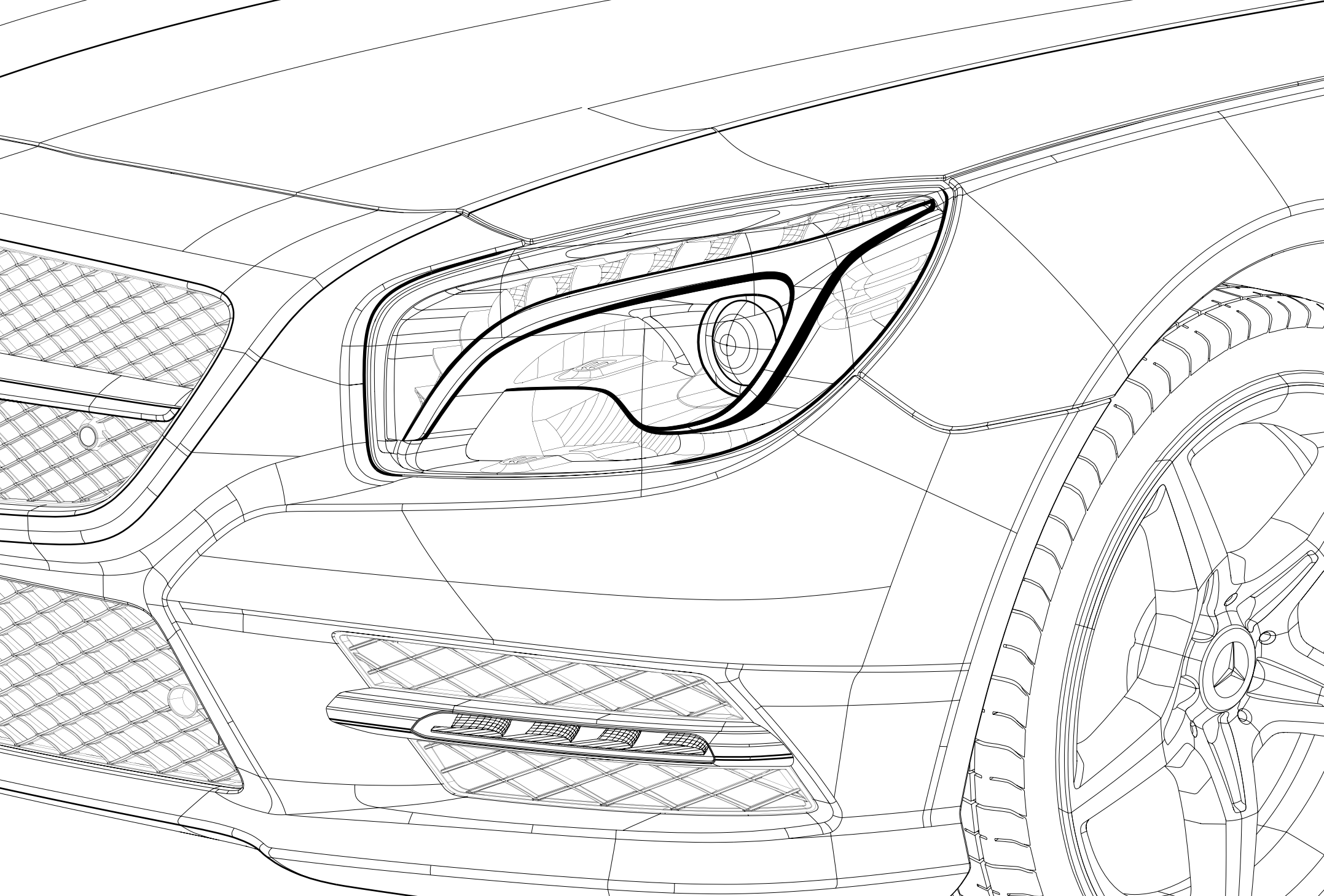

## Petrol engines.

**Built for top performance.** The SL-Class Roadster offers all the exhilarating sensations of a sports car. Powerful, high-torque engines put you in touch with speed in its most authentic form in the SL.

**6-cylinder petrol engine.** The innovative BlueDIRECT V6 engine that powers the SL 400 was developed using lightweight materials throughout. It includes spray-guided direct petrol injection with piezo injectors, four valves per cylinder and adjustable intake and exhaust camshafts.

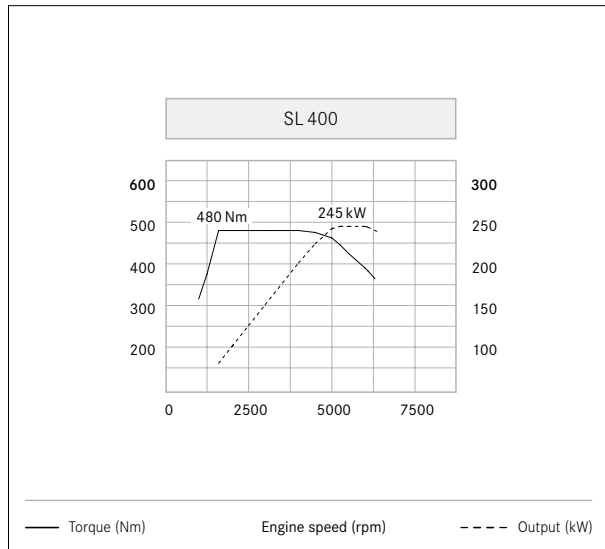

With an output of 245 kW (333 hp), the SL 400 Roadster boasts dynamic performance.

In addition to this, thanks to the trendsetting NANOSLIDE technology the friction has been optimised, and the consumption and emissions have been significantly reduced. As well as the enhanced combustion process, other factors which contribute to the reduction in fuel consumption include the standard-fit ECO start/stop function, the air intake and exhaust system, controlled ancillaries and intelligent alternator management. With an output of 245 kW (333 hp) and a torque of 480 Nm between 1600 and 4000 rpm the engine offers powerful acceleration and very smooth running characteristics across the entire engine speed range.

**8-cylinder petrol engine.** The BlueDIRECT 8-cylinder engine in the SL 500 vouches for effortless superiority in every driving situation. An array of innovative technologies makes for reduced fuel consumption and significantly higher output from a reduced displacement. The technological highlights include the systematic lightweight design, moderate downsizing to a displacement of 4.7 litres and direct injection with precise piezo injectors. Twin turbo-

chargers with charge air cooling ensure sustained high output and significantly increased torque. This is reflected in the performance data: the SL 500 with the BlueDIRECT engine develops an impressive output of 320 kW (435 hp) and a massive 700 Nm of torque between 1800 and 3500 rpm. Compared with the predecessor model, the performance is considerably more dynamic, but the fuel consumption is down by as much as 22 percent and the CO<sub>2</sub> emissions are also correspondingly lower.

Both the 6- and 8-cylinder engine are equipped as standard with the ECO start/stop function, which can help save fuel at traffic lights and in jams, thereby easing the burden on the environment.



## Transmissions.

Innovative transmission technology, optimally tuned in the SL, brings the power of the responsive, high-torque engines effortlessly to the road.

**7G-TRONIC PLUS** (standard). Optimised for lower fuel consumption and increased efficiency, the automatic transmission 7G-TRONIC PLUS with steering-wheel shift paddles takes care of changing gear in the SL. The 7G-TRONIC PLUS features the innovative torque converter which responds more dynamically, operates even more quietly and delivers a significant reduction in fuel consumption. The latter is also a result of combining the transmission with the standard-fit ECO start/stop function, which switches the engine off temporarily

when waiting at traffic lights or in a traffic jam. The seven forward gears of the 7G-TRONIC PLUS allow a wider spread between the lowest and highest ratio yet also make for smaller shifts in engine speed between one gear and the next. This ensures that the engine always operates at the optimum speed, reduces fuel consumption and renders gear changes almost imperceptible. At the same time, it makes the driving experience even more enjoyable: the vehicle's acceleration is improved and it develops greater pulling power. The manual gear-change

facility makes driving even more dynamic, with the driver always able to see the most fuel-efficient gear in the display. The transmission system automatically switches back to automatic mode, which is optimal for fuel economy, after a defined interval. The driver can also opt for manual gear changing only.



The 7G-TRONIC PLUS: one of over 19 million automatic transmissions produced in a period spanning more than 50 years.



## Chassis and suspension.

The SL-Class Roadster is as much at home cruising comfortably along country roads as it is tackling hairpin bends at a sporty tempo. This is possible thanks to the different suspension systems and settings available.

**Active Body Control ABC** (option). This system offers maximum ride comfort and enhanced driving dynamics through a combination of active suspension and passive damping. The movements of the vehicle body when moving off and braking are also significantly reduced, as is body roll when cornering. A comfort-oriented or sporty suspension setup can be selected at the touch of a button and the currently selected suspension mode can be called up in COMAND.

**Suspension with Adaptive Damping System ADS** (standard). The electronically regulated damping system adjusts its characteristics continually and steplessly, the damping force being optimally adapted to each individual wheel in accordance with the current driving situation and road conditions. This results in greater handling stability in all speed ranges. The dampers can be set to sport mode at the push of a button.

**Direct-Steer system with EPS** (standard). This system makes steering easier and leads to improved cornering. Fewer steering movements are required when manoeuvring and the electromechanically assisted steering gear (EPS) can save fuel.

**ESP® Dynamic Cornering Assist** (standard). When cornering at speed, the rear wheel on the inside of the bend is braked slightly to optimise distribution of the drive forces to the rear wheels for even sharper agility.



The standard suspension with Adaptive Damping System ADS facilitates the ideal blend of sportiness and comfort.

## Integral safety concept.

The vision of accident-free driving impels us. With our integral safety concept we are coming closer to achieving this goal – this is a holistic approach which can increase safety in every situation.

As the inventor of the car we feel that we have a special responsibility for road safety. This is why we are the first car manufacturer to have developed an integral safety concept which seamlessly blends measures to enhance active and passive safety. The holistic approach is subdivided into four phases and offers safety solutions for every situation. It includes systems for safe driving which help to avoid risks by warning you and coming to your aid in good time. Our unique PRE-SAFE® system kicks in in the event of danger and activates preventive measures for occupant protection. If a collision should still occur in spite of all the preventive measures, further technologies ensure protection as needed. We have also borne in mind the time immediately following an accident and developed solutions which can help prevent worse and facilitate rapid help.

A selection of these technologies for the “Safe driving”, “In the event of danger”, “In an accident” and “After an accident” phases is presented on the pages which follow.

**Safe driving: ATTENTION ASSIST** (standard). This drowsiness detection system is especially useful on long trips. At speeds of between 80 and 180 km/h, ATTENTION ASSIST can warn the driver as soon as it identifies typical signs of drowsiness or inattention. Several sensors analyse the driver’s behaviour and can detect any changes compared with the driver profile individually determined previously.

**Safe driving: Adaptive Highbeam Assist** (option). Taking into account oncoming traffic and vehicles in front, the system ensures that the illumination of the road and distance vision are significantly improved. The range of the low-beam headlamps is automatically adjusted to the amount of traffic on the road.

**Safe driving: Intelligent Light System** (standard). The system has five settings: the country mode illuminates the edge of the road, the motorway mode the entire width of the road. The enhanced fog light function improves visibility, whilst the active light function and the cornering light function follow the driver’s steering angle.

**Safe driving: Night View Assist Plus** (option). This system detects people, animals and objects up to 160 metres ahead on the road surface using two LED infrared headlamps and a thermal imaging camera. When the system is activated, the night vision is automatically switched on in certain relevant situations and is only switched off again when the vehicle has passed the hazardous situation. The people and animals detected are highlighted on the screen.

**Safe driving: MAGIC VISION CONTROL adaptive wiper system** (standard). This system delivers the windscreen washer fluid through the wiper blade straight to the windscreen. This improves the driver’s vision when using the windscreen washer, consumption of washer fluid is reduced and the risk of splashes reaching the interior of the car during open-top driving is reduced. The optional heated windscreen washer system, comprising heating for the windscreen washer reservoir, the adaptive wiper system and the windscreen washer lines, provides these elements with considerably greater protection against freezing.

**Safe driving: Driving Assistance package Plus** (option).

This package makes an active contribution to everyday safety on the road. It includes DISTRONIC PLUS proximity control, Active Blind Spot Assist, Active Lane Keeping Assist, BAS PLUS Brake Assist and the PRE-SAFE® Brake.

**In the event of danger: PRE-SAFE® Brake and BAS PLUS** (part of the optional Driving Assistance package Plus).

The PRE-SAFE® Brake initially provides the driver with visual and acoustic warnings when the risk of a collision is detected. In this phase, BAS PLUS calculates the amount of brake pressure that could avoid a collision. If the braking force applied by the driver is insufficient, the system increases the braking pressure automatically so as to make optimum use of the remaining distance available. If the driver fails to respond to the signal, the PRE-SAFE® Brake intervenes with autonomous partial braking that can clearly be felt. If there is still no reaction, an autonomous full brake application can then be triggered so as to significantly reduce impact speed and accident severity.

**In the event of danger: PRE-SAFE® system** (standard).

This anticipatory occupant protection system is able to detect certain critical driving situations in advance and activate precautionary measures. If an imminent accident is detected, the system can close the side windows and tension the front seat belts using electric motors.

Depending on the vehicle equipment, the passenger seat can also be brought into a position which is more favourable in accident conditions.

**In an accident: restraint systems** (standard). Three-point seat belts, belt tensioners, belt force limiters and airbags are optimally coordinated with each other in Mercedes-Benz vehicles, so as to keep injuries to a minimum wherever possible. The two-stage airbags for the driver and passenger help to protect the upper body and head, at the same time as stabilising the entire body. The standard headbags and sidebags, meanwhile, are able to reduce the risk of injury in a side impact. The various airbags therefore allow impact protection to be adapted to requirements. If the airbag control unit detects an accident, the seat belts are automatically tightened at lightning speed. The belt force limiter then relaxes the

belt again in accordance with the particular situation, so as not to place too much of a strain on the occupant's chest.

**After an accident: Mercedes-Benz emergency call system**<sup>1</sup> (part of COMAND Online).

This system is able to send an automatic emergency call using an operational mobile phone connected to the vehicle as soon as the restraint system recognises an accident. At the same time it communicates GPS positional data and other information on the car to the Mercedes-Benz emergency call centre. A voice connection is then established.

**Measures after an accident.** In order to reduce consequential damage and, where necessary, to support the rescue of the occupants, Mercedes-Benz has developed further measures. These include automatic engine cut-off and activation of the hazard warning lamps and interior emergency illumination. The central locking also unlocks automatically, and crash joints between the door and the wing make it easier to open the doors after an accident.

## Multimedia systems.

Everything revolves around maximum comfort and convenience. While the standard-fit Frontbass technology delivers breathtaking acoustic performance, the optional COMAND Online multimedia system provides entertainment and navigation.

**Bang & Olufsen BeoSound AMG** (option). With its 12 high-performance loudspeakers the 900-watt high-end surround sound system with Frontbass turns the interior into a concert hall. For even better bass performance the resonant volume of the bass loudspeakers is integrated into the bodyshell. In conjunction with the tweeters with Acoustic Lens Technology a unique sound stage is created – even during open-top motoring.



Music performance you can see: outstanding audio technology with an exclusive design.

**Harman Kardon® Logic 7® surround sound system** (option). Harman Kardon® Logic 7® surround sound system with Frontbass, Dolby Digital 5.1 and 600 watts of power turns every journey into an acoustic experience. Eleven high-performance loudspeakers and an amplifier with Digital Sound Processing provide a three-dimensional sound impression. The automatic volume control adapts the sound in line with the car's current speed.

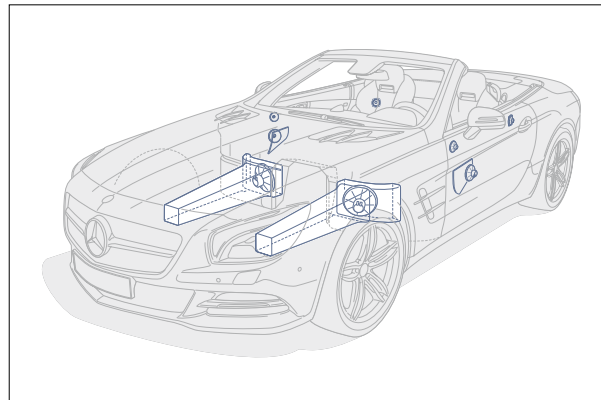

The unique Frontbass sound system with the woofers integrated into the body of the SL ensures new dimensions of sound.

**COMAND Online** (standard, option for SL 400). The intelligent multimedia system with access to the internet combines all the audio, telephone and navigation functions. The centrepiece is the brilliant display with TFT technology and a 17.8-centimetre screen diagonal. The functions include a radio with a combined DVD/CD drive, speed-sensitive volume control, the MUSIC Register with its 10 GB hard disc and hard-disc navigation with topographical map display and free updates in the first three years. The optional SPLITVIEW allows the driver and passenger to view two different things on the screen at the same time. It is as easy and intuitive to control as never before.

**Live Traffic Information<sup>1</sup>** (part of COMAND Online). This service allows the reception of up-to-date and precise traffic information in real time for optimised dynamic route guidance and more accurately calculated arrival times. The data are transferred via a communications module which uses an integral SIM card with data roaming to provide the connection to the internet.

<sup>1</sup> 3 years of free use, available in 12 countries.

## Assistance systems.

There are numerous assistance systems to reduce the driver's workload, both on the open road and when performing difficult manoeuvres.

**Speed Limit Assist** (part of the optional COMAND Online). A windscreen-mounted camera that permanently scans the car's surroundings is able to recognise signed speed limits and indicate the detected maximum speed to the driver in the display. The driver can therefore check the prevailing speed limit. This added convenience is of particular benefit on routes with variable speed limits or roadworks.



The information from Speed Limit Assist is shown both in the instrument cluster and in the COMAND Online central display.

**Active Parking Assist, including PARKTRONIC** (option). At a speed below 36 km/h the car looks for a suitable parking space and automatically enters the parking space at the press of a button, whilst the driver merely operates the accelerator pedal and brake. If the driver does not wish to use Active Parking Assist, the PARKTRONIC electronic parking assistance system monitors the front and rear area while the driver is manoeuvring the vehicle and warns the driver if a risk of collision is detected.



Active Parking Assist shows the driver suitable parking spaces and can carry out the parking manoeuvre if required.

**Lane Keeping Assist** (option). The system warns the driver via steering wheel vibrations as soon as it detects that the vehicle is leaving its lane unintentionally. This is possible thanks to a camera on the inside of the windscreen which films the road. The warning is not given if the driver accelerates, for example, before an overtaking manoeuvre or when driving onto the motorway, if they brake sharply or steer into a bend.



The Lane Keeping Assist warns the driver by vibrating the steering wheel if the car moves out of the lane unintentionally.

## Open-air comfort.

The SL-Class Roadster offers its occupants comprehensive open-air comfort of the highest standard – in every season and almost any weather.

**AIRSCARF** (option). The neck-level heating developed by Mercedes-Benz extends the open-air season. At the touch of a button air is wrapped around the shoulders and neck of the driver and passenger like a warming scarf. In order to achieve this effect the system draws in cold air before warming it and releasing it again through discreetly positioned vents in the head restraints.



AIRSCARF delivers warm air to ensure perfect open-top motoring pleasure even in cool weather.

**Draught-stop, electric** (option). When driving with the roof down, the electrically operated draught-stop ensures optimum protection from draughts if the driver or passenger touches a button on the centre console. This triggers an electric motor which deploys a trapezoidal frame from the rear compartment trim cover. The fine-mesh textile fabric covering the frame keeps the passenger area almost entirely free of draughts.



The electric draught-stop minimises draughts in the interior of the open vehicle.

**Sun-reflecting leather** (standard in conjunction with leather, nappa leather and Exclusive nappa leather except designo leather). As an optional extra the SL's seats are available with a coating which reflects heat. This prevents the seats from heating up in intense sunlight – bringing extra comfort, particularly when the vehicle is open.



## Roof and space.

When it comes to comfort, the SL provides the benchmark. On the one hand, the panoramic vario-roof with MAGIC SKY CONTROL creates an impression of space and airiness even in the closed vehicle. On the other, all the roof variants offer lots of room for luggage even when the car is open.



**Panoramic vario-roof with MAGIC SKY CONTROL** (option). The panoramic vario-roof with MAGIC SKY CONTROL is an innovation from Mercedes-Benz. The roof changes colour at the touch of a button from dark to transparent and vice-versa in a matter of seconds. In this way the driver and passenger can enjoy a view of the sky even when the roof is closed. And when the glass is darkened, the vehicle interior heats up considerably less.





**Vario-roof** (standard). The fully power-retractable vario-roof transforms the SL from a coupé to an open roadster at the touch of a button. It takes less than 20 seconds to open or close the roof, which also comes as standard with a radio remote control function allowing it to be operated from outside the vehicle by means of the vehicle key. And thanks to the compact design of the roof, up to 241 litres of boot space remain available when it is retracted.



The roadster's boot offers plenty of stowage space whether the roof is open or closed.

**Panoramic vario-roof, including roller blind** (option). The panoramic vario-roof allows you to enjoy the views offered by a roadster with the comfort of a closed coupé. A large tinted glass panel integrated in the roof provides a clear overhead view. A manually operated roller blind offers protection from the sun when required.



Thanks to the panoramic vario-roof the occupants can enjoy an excellent view even when the roof is closed.

**EASY-PACK function** (standard). With the roof down, the convenient EASY-PACK function improves access to items in the boot by means of a power-operated mechanism which lifts the stowed roof. When the "close" button is pressed, the roof is lowered to the retracted position once again and the boot lid is closed.

**KEYLESS-GO Convenience package with HANDS-FREE ACCESS** (option). There is no need to have the key in your hand to open the car or start the engine. If you have the KEYLESS-GO key on you, all you have to do is operate the door handle. The car is started by simply pressing the start/stop button. The HANDS-FREE ACCESS convenience function makes loading and unloading the boot easier by using a sensor to trigger automatic opening or closing of the boot lid when the driver's foot is detected beneath the rear of the vehicle.

## Climate control and light.

A pleasant interior climate increases motoring pleasure and driver-fitness safety, so in the SL the temperature can be individually regulated, and the interior stylishly showcased in darkness.

**THERMOTRONIC** (standard). The THERMOTRONIC automatic climate control has separate temperature controls for each side of the interior, allowing the driver and passenger to travel in comfort at the temperature of their choice. At the touch of a button the 2-zone system works fully automatically. THERMOTRONIC keeps the desired tempera-

ture constant and also takes exterior factors such as sunlight, air quality and humidity into account via its sensors. The system also comprises a particulate matter activated charcoal filter, which reduces dust, soot and pollen in the air as well as pollutants and odours. This means that there is always a pleasant atmosphere in the SL,

boosting comfort on the one hand and the driver's concentration on the other, thus enhancing the safety of both occupants. What's more, automatic mode can be adapted individually with the three climate styles DIFFUSE, MEDIUM and FOCUS.

**Ambient lighting** (option). The ambient lighting provides a pleasant indirect lighting effect inside the vehicle at night. Luminous surfaces on the dashboard, below the door trim and in the rear compartment trim cover create a unique atmosphere. The ambient lighting is activated and deactivated with the exterior lighting. It is also switched on when the doors are opened in order to create a "welcome home" effect. It is possible to switch between three ambient lighting colours – solar orange, solar red and solar yellow – which can also be dimmed to emphasise the sporty interior design.



The standard-fit THERMOTRONIC luxury automatic climate control ensures a pleasant interior temperature.



## Seats.

The sporty seats in the SL meet the highest standards – and diverse requirements – in terms of ergonomic design, comfort and safety.

The design of the comfortable sports seats speaks for itself. With their high side bolsters, these ergonomic seats offer optimal lateral support and enhance stability for the driver and passenger noticeably, even during dynamic driving. The exquisite leather variants which are available as an option are extremely pleasant to the touch and have the added benefit of reflecting sunlight.

The optional multicontour seats relieve the load on the spinal column and can be adjusted precisely to meet the ergonomic requirements of the driver and passenger. The pressure in the variable air cushions in the side bolsters of the backrests can be adjusted in line with individual requirements, as can the backrest curvature in the lumbar and shoulder regions. The active multicontour seat takes the outstanding qualities of these seats even further. It adjusts continuously to the changing lateral acceleration

forces, massages the back muscles and can reduce the risk of injury in an accident.

The seat heating, standard from V8, immediately brings cold seats up to a pleasantly warm temperature, before the effect of the car's heating can be felt, and allows independent heating of each seat to three different levels. The heating distribution between the seat and the backrest can be varied, too. The optional climatized seats for the driver and passenger feature fans integrated in the upholstery. The air flows through the fine perforation and quickly cools down the surface of the seats to a pleasant temperature – even if the car has been heated by intense sunlight for a longer period of time. Maximum ease of operation is assured by the standard-fit fully power-adjustable seats with 4-way lumbar support and Memory function. The electropneumatic lumbar support promotes

an ergonomic posture while the Memory function makes it possible to store – and recall at the touch of a button – the positions of the seat and backrest, the steering wheel and the exterior mirrors on both sides.



Standard-fit electric seat adjustment with Memory function.





## SL 63 AMG.

The SL 63 AMG Roadster impresses with its expressive design and innovative technology from the world of motorsport. → [www.mercedes-amg.com](http://www.mercedes-amg.com)

Its expressive exterior hints at the power that lies within. The SL 63 AMG demonstrates its forwards-thrusting energy through its dynamic AMG bodystyling consisting of a front apron with side air outlets, a diffuser-look rear apron with an insert in the vehicle colour and side sill panels. Silver chrome, a signature styling feature of the SL 63 AMG, is used for the lower cross strut of the front apron, the twin louvre in the AMG radiator grille and the surrounds of the special AMG LED daytime running lamps as well as the fins on the bonnet and wings. These features are complemented by the AMG spoiler lip on the boot lid and the AMG 5-twin-spoke light-alloy wheels. An AMG sports

exhaust system with two chromed twin tailpipes and “V8 BITURBO” lettering on the front wings complete the sporty look.

The interior also impresses with an exceptionally sporty ambience created by AMG sports seats in nappa leather with a special AMG upholstery layout, AMG carbon-fibre trim, black roof liner and ambient lighting. One look at the AMG performance steering wheel trimmed in nappa leather with silver-coloured aluminium shift paddles, the AMG DRIVE UNIT with the E-SELECT lever and the AMG instrument cluster with its AMG start-up display is

enough to create the feeling of being in the cockpit of a racing car. The integral RACETIMER can even record lap times if you ever take to the race circuit. An analogue IWC-design clock is another highlight, while AMG door sill panels in brushed stainless steel with white illumination add an appropriately stylish finishing touch.



AMG sports seats in nappa leather.



The AMG DRIVE UNIT in the centre console.



The AMG sports exhaust system with two chromed twin tailpipes.

## SL 63 AMG technical details.

A thrilling driving experience and maximum efficiency with the AMG 5.5-litre V8 twin-turbocharged engine, the AMG SPEEDSHIFT MCT 7-speed sports transmission and the AMG sports suspension.

**AMG 5.5-litre V8 twin-turbocharged engine.** The high-performance engine of the SL 63 AMG is built to deliver dynamic performance without neglecting economy. It offers breathtaking acceleration and outstanding performance with an engine note to set your pulse racing. The power-plant develops an impressive maximum output of 430 kW (585 hp) with a maximum torque of 900 Nm. The AMG high-

performance compound braking system delivers excellent deceleration performance plus precision brake control with internally ventilated and perforated brake discs sized 390x36 mm at the front axle and 360x26 mm at the rear axle.

**AMG SPEEDSHIFT MCT 7-speed sports transmission.**

It combines the direct feedback of a manual transmission with the comfort of an automatic. The four transmission modes – Controlled Efficiency, Sport, Sport+ and Manual – as well as the RACESTART function allow the driver to choose how dynamic the gear changes are to be.

**AMG sports suspension.** The enhanced active suspension Active Body Control ABC offers a choice of two settings: comfort and sport. This causes a corresponding adjustment to be made to the steering characteristics of the AMG speed-sensitive sports steering. This gives the driver a sensitive and direct steering response with immediate feedback from the road, and the AMG sports suspension therefore ensures compelling driving enjoyment.

**AMG rear-axle locking differential.** The SL 63 AMG comes as standard with an AMG rear-axle locking differential which is specifically matched to the vehicle and which reduces the slip on the inner wheel in bends. This means that it is possible to accelerate out of the bend earlier. When braking and at a high speed the car is stabilised.



Fast, comfortable gear changing with the AMG SPEEDSHIFT MCT 7-speed sports transmission.



The AMG 5.5-litre V8 biturbo engine with 430 kW (585 hp) and 900 Nm torque.







## SL 65 AMG.

The SL 65 AMG brings even greater luxury and exclusivity to this legendary model series.

The exterior of the top model differs from that of the SL 63 AMG in that the former features an AMG sports exhaust system with special AMG-design chromed twin tailpipes, the “V12 BITURBO” lettering on the wings and the chromed cross strut in the front apron. These elements are complemented by the high-gloss chromed finish of the twin louvre in the AMG radiator grille as well as the fins on the bonnet and wings. Special V12 AMG 5-spoke light-alloy wheels, the characteristic AMG body-styling and the AMG spoiler lip on the boot lid complete the picture of a consummate sports car.

The exclusive tone is maintained inside the vehicle. Exclusive nappa leather upholstery offers an irresistible invitation to settle into the AMG sports seats whose backrests feature an embossed AMG emblem. The special AMG seat upholstery layout harmonises with the AMG-specific design of the door centre panels and the designo roof liner in black leather. The equipment line-up also includes the Convenience Telephony function, the KEYLESS-GO package and Active Parking Assist as well as AIRSCARF, multicontour seats and climatised seats. The AMG performance steering wheel trimmed in nappa leather with silver-coloured aluminium shift paddles hints at the thrill-

ing driving experience in store, as do the AMG instrument cluster with the “AMG V12 BITURBO” start-up display and the AMG DRIVE UNIT with the E-SELECT lever which bears an embossed AMG emblem. The ambient lighting and the transparent panoramic vario-roof with a roller blind also help to set the scene, while the high-end Bang & Olufsen BeoSound AMG surround sound system provides the soundtrack. High-sheen chromed AMG door sill panels with white illumination, the special AMG IWC-design analogue clock and AMG carbon-fibre trim complete the elegant and sporty picture.



AMG sports seats in Exclusive nappa leather with AMG-specific seat upholstery layout.



The AMG instrument cluster in the SL 65 AMG.



AMG sports exhaust system with AMG-design twin tailpipes.

## SL 65 AMG technical details.

With its AMG 6.0-litre V12 twin-turbocharged engine and automatic transmission AMG SPEEDSHIFT PLUS 7G-TRONIC, the SL 65 AMG is the flagship of the SL model series.

**AMG 6.0-litre V12 biturbo engine.** The 12-cylinder high-performance engine with the ECO start/stop function boasts excellent output values, innovative engineering and optimum refinement. The top-of-the-range engine achieves 463 kW (630 hp) and reaches its maximum torque of 1000 Nm as early as 2500 revs per minute – and retains it up to 4300 revs per minute. As is the case with the SL 63 AMG the AMG high-performance compound braking system ensures impressive deceleration values.



A first in a 12-cylinder model from Mercedes-Benz: AMG SPEEDSHIFT PLUS 7G-TRONIC automatic transmission.

**Automatic transmission AMG SPEEDSHIFT PLUS 7G-TRONIC.** Equipped with four transmission modes, it facilitates high efficiency with enhanced driving dynamics. The chosen transmission mode is activated via a rotary switch, placing the emphasis on sportiness or comfort. The automatic double-declutching function when shifting down causes a reduction in the load alteration effect, which is particularly positive when braking on approaching bends. It also gives you an emotive sound experience.



AMG rear-axle locking differential with 40% locking effect.

**AMG rear-axle locking differential.** The SL 65 AMG, too, comes as standard with an AMG rear-axle locking differential which is specifically matched to the vehicle and which reduces the slip on the inner wheel in bends. This means that it is possible to accelerate out of the bend earlier. When braking and at a high speed the car is stabilised.

**AMG sports suspension.** Like the SL 63 AMG, the SL 65 AMG is equipped with the AMG sports suspension, based on Active Body Control ABC, and AMG speed-sensitive sports steering.

**Electronic Stability Program ESP®.** The SL 63 AMG and the SL 65 AMG are equipped with 3-stage ESP®, which allows three different control strategies offering both safety and driving enjoyment to be selected at the touch of a button. Using the ESP® switch the driver can choose between “ESP ON”, “ESP SPORT HANDLING MODE” and “ESP OFF”. When the driving style is sporty the ESP® Dynamic Cornering Assist ensures more roadholding and more safety by distributing the drive forces to the wheels in a targeted manner.



## AMG Performance Studio.

The sporty look of the AMG models is given the perfect finishing touch with the individualisation options from the AMG Performance Studio.

The impressive performance of the SL 63 AMG and the SL 65 AMG can be heightened and visually accentuated even further with a wide range of optional extras from the AMG Performance Studio. One of the highlights is the AMG Exterior Carbon-Fibre package, which adds sporty flourishes from all angles with high-quality appliqué sections in genuine carbon fibre: from the cross strut in the front apron, through the exterior mirror housing to the AMG spoiler lip on the boot lid. A further example is the AMG ceramic high-performance compound braking system with a weight saving of around 40% and the life of

the brake discs increased several times over. Or the AMG 10-spoke forged wheels – either painted titanium grey and with a high-sheen finish or painted matt black, in each case with 255/35 R 19 front and 285/30 R 20 rear tyres. Further symbols of this sports car's exceptional status are the red-painted brake callipers available as an individual optional extra and the exclusive AMG engine cover in carbon fibre for the SL 63 AMG. In the interior the AMG performance steering wheel is impressive in nappa leather/Alcantara®. With the optional AMG Driver's Package the maximum speed is not limited until 300 km/h,

and at the AMG Driving Academy's one-day training course the driver learns how to handle the car safely and sportily under professional instruction. For motorsport and technology fans the AMG Performance Media captures and visualises vehicle-specific data as well as racetrack information.

The AMG Performance Studio in Affalterbach can also meet other customer requests – including the production of one-off models. You also have the option of collecting your car in person in Affalterbach.



The SL 63 AMG with the AMG Exterior Carbon-Fibre package.



AMG 10-spoke forged wheels with brake callipers painted red.



AMG ceramic high-performance compound braking system.



## Standard equipment | Selection.



The MAGIC VISION CONTROL adaptive wiper system.



Instrument cluster with display with TFT technology.



Intelligent Light System.



Suspension with Adaptive Damping System ADS.



Selector lever in the centre console.



Multifunction sports steering wheel in nappa leather with shift paddles.



## Optional extras | Selection.



KEYLESS-GO Convenience pack. w. HANDS-FREE ACCESS (SL 65 AMG: stand.).



Electric draught-stop.



SPLITVIEW with 6-disc DVD changer.



COMAND Online with DVD drive (standard for SL 500 and above).



Bang & Olufsen BeoSound AMG (standard on SL 65 AMG).



Panoramic vario-roof with MAGIC SKY CONTROL.

## AMG Line exterior.

Athletic, dynamic, powerful. The optional AMG Line brings out these characteristics even more potently.

The AMG Line is the perfect choice for further emphasising the sportiness and dynamic spirit of the SL-Class Roadster. The AMG bodystyling, comprising a front and rear apron and side sill panels, underlines the vehicle's strength and athleticism. AMG light-alloy wheels with 255/35 R 19 tyres

at the front and 285/30 R 19 at the rear enhance the overall look. Pure driving pleasure is assured by the 7G-TRONIC PLUS transmission, with shift points optimised for sporty performance in the S transmission mode, and the sports suspension which is lowered by 10 millimetres and has

a tauter spring response and damping setup (deselectable, not with Active Body Control ABC). The uprated braking system, with perforated brake discs at the rear too, and "Mercedes-Benz" lettering on the grey-painted brake callipers, completes the AMG Line to perfection.



The distinctive rear apron – part of the AMG Line.



High-shine AMG 5-spoke light-alloy wheels.



High-shine AMG 7-twin-spoke light-alloy wheels, finished in titanium grey.



## AMG Line interior.

The powerful character of the SL-Class Roadster with the optional AMG Line is systematically continued in the vehicle interior.

The interior concept of the AMG Line also impresses with its sporty details. Appointments and equipment specific to this package include the instrument cluster with its “Chequered Flag” design, the sports steering wheel with a flattened bottom section as well as silver-coloured

shift paddles and perforated leather in the grip area, and the sports seats with their vertical fluting which are available in leather, nappa leather or Exclusive nappa leather (black and perforated in each case). White piping on the door armrests, centre console, seat side bolsters and head

restraints provides an attractive contrast. The trim is available in a choice of light or dark longitudinal-grain aluminium. AMG floor mats are another exclusive feature of this package.



The instrument cluster with its “Chequered Flag” design.



The AMG Line interior with dark longitudinal-grain aluminium trim.



Light longitudinal-grain aluminium trim.





## designo.

A wealth of high-grade appointments and special details makes designo an alluring proposition. → [www.mercedes-benz.com/designo](http://www.mercedes-benz.com/designo)

The optional designo range allows you to take the sporty design of the SL-Class Roadster into another dimension of perfection. The comprehensive designo range offers discerning customers a choice of attractive upholstery in designo leather as well as numerous roof liner options in DINAMICA microfibre or leather. designo trim, which is

manufactured with the greatest care, is available in natural bamboo, black piano lacquer, champagne white piano lacquer or AMG carbon fibre. The two-tone designo leather steering wheel is optionally available in all eight designo interior colours. Exclusive designo paint finishes focus attention on the exterior design. You can choose from

designo metallic paint finishes or designo magno matt paint finishes. Whether the effect being sought is a harmonious combination of colours or contrasting highlights, designo underlines the exclusivity of the SL-Class Roadster.



Trim in designo black piano lacquer (Code W69).



designo roof liner in DINAMICA.



designo seat belts in red.

## Upholstery and trim.



The black colour scheme features black seats which are available either in leather/fabric or, as an option, in leather, nappa leather or Exclusive nappa leather. The contrasting topstitching in dark alpaca grey adds an eye-catching note in conjunction with leather/fabric or leather. Where nappa leather or Exclusive nappa leather is ordered, black topstitching and dark alpaca grey piping underline the stylish character of the interior. The centre console is in machined aluminium as standard, the metallic surfaces in fine silver chrome.

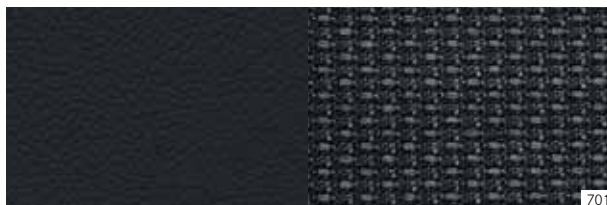

---

### black

---

- 701 Leather/fabric
  - 201 Leather
  - 801 Nappa leather
  - 501 Exclusive nappa leather
- 

### Trim

---

- H76 Dark longitudinal-grain aluminium (option, with AMG Line)
  - 736 High-gloss black ash wood (option)
  - 739 Light longitudinal-grain aluminium
  - 731 High-gloss brown burr walnut wood (option)
  - 729 Satin-finish light brown poplar wood (option)
-





The nut brown colour scheme features nut brown seats which are available in nappa leather or Exclusive nappa leather. The topstitching of the seat surfaces is in brown, the contrasting stitching on the side bolsters in black. Black piping adds an eye-catching note. The centre console is in machined aluminium as standard, the metallic surfaces in fine silver chrome.



804  
504



736



739



731



729

---

**nut brown** (option)

---

804 Nappa leather

504 Exclusive nappa leather

---

**Trim**

---

736 High-gloss black ash wood (option)

739 Light longitudinal-grain aluminium

731 High-gloss brown burr walnut wood (option)

729 Satin-finish light brown poplar wood (option)

---



The ginger beige/espresso brown colour scheme features ginger beige seats which are available in leather, nappa leather or Exclusive nappa leather. Contrasting topstitching in como beige adds an eye-catching note. Where nappa leather or Exclusive nappa leather is ordered, piping in espresso brown underlines the stylish character of the interior. The centre console is in machined aluminium as standard, while the metallic surfaces are in fine silver chrome.

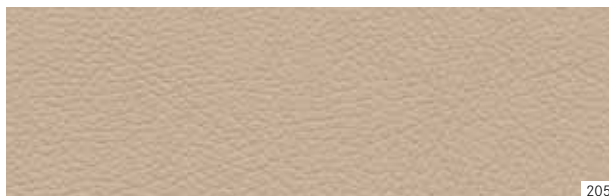

205



736

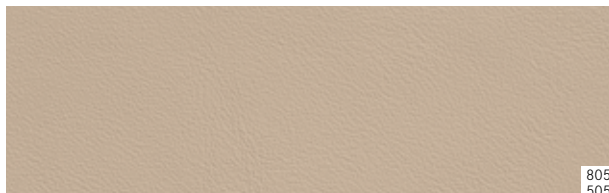

739

805  
505

731



729

---

**ginger beige/espresso brown (option)**

---

- 205 Leather
  - 805 Nappa leather
  - 505 Exclusive nappa leather
- 

**Trim**

---

- 736 High-gloss black ash wood (option)
  - 739 Light longitudinal-grain aluminium
  - 731 High-gloss brown burr walnut wood (option)
  - 729 Satin-finish light brown poplar wood (option)
-



The bengal red colour scheme features bengal red seats which are available in leather, nappa leather or Exclusive nappa leather. Black contrasting topstitching adds an eye-catching note in conjunction with leather. Where nappa leather or Exclusive nappa leather is ordered, black topstitching and black piping underline the stylish character of the interior. The centre console is in machined aluminium as standard, the metallic surfaces in fine silver chrome.



207



807  
507



736



739



731



729

---

**bengal red (option)**

---

- 207 Leather
  - 807 Nappa leather
  - 507 Exclusive nappa leather
- 

**Trim**

---

- 736 High-gloss black ash wood (option)
  - 739 Light longitudinal-grain aluminium
  - 731 High-gloss brown burr walnut wood (option)
  - 729 Satin-finish light brown poplar wood (option)
-



The crystal grey colour scheme features crystal grey seats which are available in embossed leather. Mid grey contrasting topstitching adds an eye-catching note. The centre console is in machined aluminium as standard, the metallic surfaces in fine silver chrome.



208



736



739



731



729

---

**crystal grey** (option)

---

208 Leather

---

**Trim**

---

736 High-gloss black ash wood (option)

739 Light longitudinal-grain aluminium

731 High-gloss brown burr walnut wood (option)

729 Satin-finish light brown poplar wood (option)

---

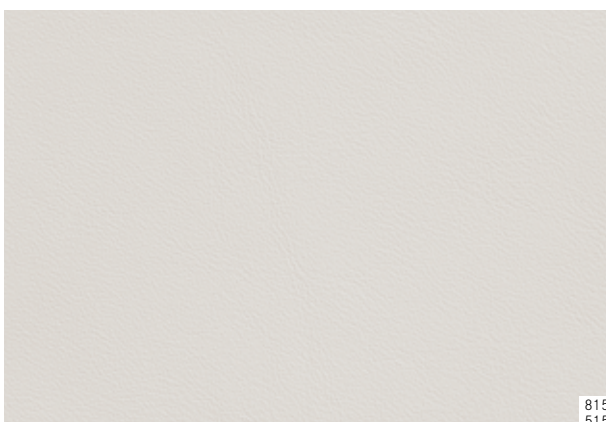

The porcelain colour scheme features porcelain-coloured seats which are available in nappa leather or Exclusive nappa leather. Black piping with porcelain-coloured top-stitching adds an eye-catching note. The centre console is in machined aluminium as standard, the metallic surfaces in fine silver chrome.

815  
515

736



739



731



729

---

**porcelain (option)**

---

815 Nappa leather

515 Exclusive nappa leather

---

**Trim**

---

736 High-gloss black ash wood (option)

739 Light longitudinal-grain aluminium

731 High-gloss brown burr walnut wood (option)

729 Satin-finish light brown poplar wood (option)

## Wheels.



10-spoke light-alloy wheels, painted titanium silver, with 255/45 R 17 tyres (standard for SL 400, Code 25R).



5-twin-spoke light-alloy wheels, painted vanadium silver, with 255/40 R 18 front tyres and 285/35 R 18 rear tyres (option, Code R70).



AMG 5-spoke light-alloy wheels with a high-sheen finish, with 255/35 R 19 front tyres and 285/30 R 19 rear tyres (part of the AMG Line, Code 770).



Multi-spoke light-alloy wheels, painted vanadium silver, with 255/40 R 18 front tyres and 285/35 R 18 rear tyres (standard for SL 500, Code R34).



5-twin-spoke light-alloy wheels, painted vanadium silver, with 255/35 R 19 front tyres and 285/30 R 19 rear tyres (option, Code R17).



AMG 5-twin-spoke light-alloy wheels, painted titanium grey with a high-sheen finish, with 255/35 R 19 front tyres and 285/30 R 19 rear tyres (standard for SL 63 AMG, Code 793).



AMG 5-spoke light-alloy wheels, painted titanium grey with a high-sheen finish, with 255/35 R 19 front tyres and 285/30 R 19 rear tyres (standard for SL 65 AMG, Code 797).



AMG 7-twin-spoke light-alloy wheels painted high-gloss black with a high-sheen finish, with 255/35 R 19 front tyres and 285/30 R 19 rear tyres (option, part of the AMG Line, Code 662).



AMG 10-spoke forged wheels painted matt black and with a high-sheen rim flange, with 255/35 R 19 front tyres and 285/30 R 20 rear tyres (option, only for AMG models, Code 767).



AMG 7-twin-spoke light-alloy wheels, painted titanium grey and with a high-sheen finish, with 255/35 R 19 front tyres and 285/30 R 19 rear tyres (option, part of the AMG Line, Code 785).



AMG 10-spoke forged wheels, painted titanium grey with a polished finish, with 255/35 R 19 front tyres and 285/30 R 20 rear tyres (option, only for AMG models, Code 766).



Multi-spoke light-alloy wheels, with a high-sheen finish, with 255/35 R 19 front tyres and 285/30 R 19 rear tyres optionally available for the rear (ex-factory accessory wheel, Code 11R).





## Genuine Accessories.

The Mercedes-Benz Genuine Accessories range offers everything you need to make the SL even sportier: a whole host of accessory products optimally tailored to the car.  
→ [www.mercedes-benz-accessories.com](http://www.mercedes-benz-accessories.com)

Make your roadster even more emphatically your own. Make a distinctive visual statement with your choice of light-alloy wheels, or add practical accessories to enhance the functionality of your SL. All products are perfectly matched to your car and are distinguished by their high levels of quality and safety. A selection from the range of accessories: the tailor-made telephone cradle automatically adapts your iPhone® in conjunction with the optional extra Convenience Telephony (Code 386) to your car's hands-free system. As well as providing optimum reception quality, battery charging and access to the internal phone memory, the system allows the phone to be operated conveniently by means of the vehicle controls. Cradles are available for many popular mobile phones.

Experience the perfect dimension of web access, telephony and navigation support in your SL with the combination of the Mercedes-Benz Bluetooth® (SAP profile) telephone module and the COMAND Online multimedia system. The telephone module with an integral UMTS module and a direct connection to the car's aerial ensures that COMAND Online has a fast, stable and reliable internet connection. You can use the phone and simultaneously use Mercedes-Benz Apps via COMAND Online and have the system read SMS messages to you. The telephone module is easily linked with the Convenience Telephony feature in the centre armrest.

The practical boot tub matches the shape of the boot precisely. It is flat, very easy to clean and made from food-safe material. The ribbed texture of the tub helps prevent the load from sliding.

To find out more, please see our accessories brochure or consult your authorised Mercedes-Benz dealer, who will be pleased to advise you.



Practical: the flat boot tub.



## More than simply a star. A whole universe.

The range of **services from Mercedes-Benz**. Every Mercedes brings with it as a standard feature a reassuring feeling of safety on the road. But if you ever do need help, we're here for you around the clock. You can reach us from anywhere in Europe on the toll-free number 00800 1 777 7777<sup>1</sup> (or alternatively direct through Mercedes-Benz Contact<sup>2</sup>).

Ensuring that you can keep moving in the event of a technical breakdown, accident, vandalism or even misfuelling, the **Mercedes-Benz mobility package Mobilo<sup>3</sup>** is included as part of the standard specification. It covers the cost of local assistance, for example for towing your car away or for a replacement vehicle – and will do so in more than 40 countries across Europe for up to 30 years<sup>3</sup>. Furthermore, for the first four years following initial registration of the vehicle, Mobilo offers special mobility services in the case of workshop visits involving warranty or goodwill situations.

Avoid unexpected workshop costs<sup>4</sup>: a **Mercedes-Benz Service Contract** covers unforeseeable repairs, maintenance or wear parts, depending on the specific contract. Your local Mercedes-Benz dealer will be pleased to provide information about available Service Contracts and terms and conditions.

**Mercedes-Benz Financial Services.** Drive a Mercedes-Benz and remain flexible when it comes to payment: our attractive leasing and finance products make this possible – matched to your requirements and needs. We will also be happy to offer you a range of detailed insurance proposals. Just speak to your Mercedes-Benz dealer, who will be happy to provide information about our current range of financial services, terms and conditions.

<sup>1</sup> Alternatively: +49 69 95 30 72 77. Calls to a landline are chargeable. <sup>2</sup> Calls from a mobile phone to a landline are chargeable. <sup>3</sup> When it expires, (four years after initial registration) Mobilo can be extended to up to 30 years from one service to the next by your authorised Mercedes-Benz service partner. <sup>4</sup> Mercedes-Benz service contract terms and conditions apply.

**Enjoy the digital experience of Mercedes-Benz** – wherever you happen to be. Thanks to a range of offers optimised for smartphones and tablet computers, you can immerse yourself in the world of Mercedes-Benz even while on the move.

Insights into the full product range, a varied programme of entertainment and direct contact to a wide variety of services await you. Take an interactive tour with the **Interactive Owner's Manual**, for example, to get to know your dream car better. Experience the various functions in detail, take a close-up look at what's going on inside or explore the benefits of the particular model on your national Mercedes-Benz website.

With the **"Mercedes-Benz Guides"** app you can also explore the highlights of the various vehicles off-line. The app is available free of charge from the Apple® iTunes® Store (iOS) or the Google Play Store (Android).

Incidentally, our TV and magazine media are also available to watch and read digitally. Explore the whole brand world for yourself at [www.mercedes-benz.com](http://www.mercedes-benz.com). Just click to take a look.

The **fascination of Mercedes-Benz**. A car whose name brings a gleam to the eyes of people all over the world, one that has featured in many a movie and been sung about in international hits, is surely far more than just a car. How did it come to this?

Discover just what has been moving the world for more than 125 years and take a fascinating journey through time as well as through the history of the automobile, in the **Mercedes-Benz Museum**. More than 1500 exhibits over a display area of 16500 square metres demonstrate the unique heritage and innovative power of the inventor of the automobile, among them one-off models such as the oldest Mercedes still in existence, built in 1902, or the legendary "Gullwing" cars. Welcome to a place of innovation: [www.mercedes-benz-classic.com/museum](http://www.mercedes-benz-classic.com/museum)

What would the history of Mercedes-Benz be like without **motorsport**? What would motorsport be without Mercedes-Benz? The first vehicle ever to win an automobile race was powered by a Daimler engine. The first Mercedes was a racing car. The Silver Arrows – a true legend. Out of this glorious past has grown an exciting present: the MERCEDES AMG PETRONAS Formula 1 team and the DTM Mercedes AMG C-Coupés fight it out weekend after weekend for points and victory.



## Dimensions.

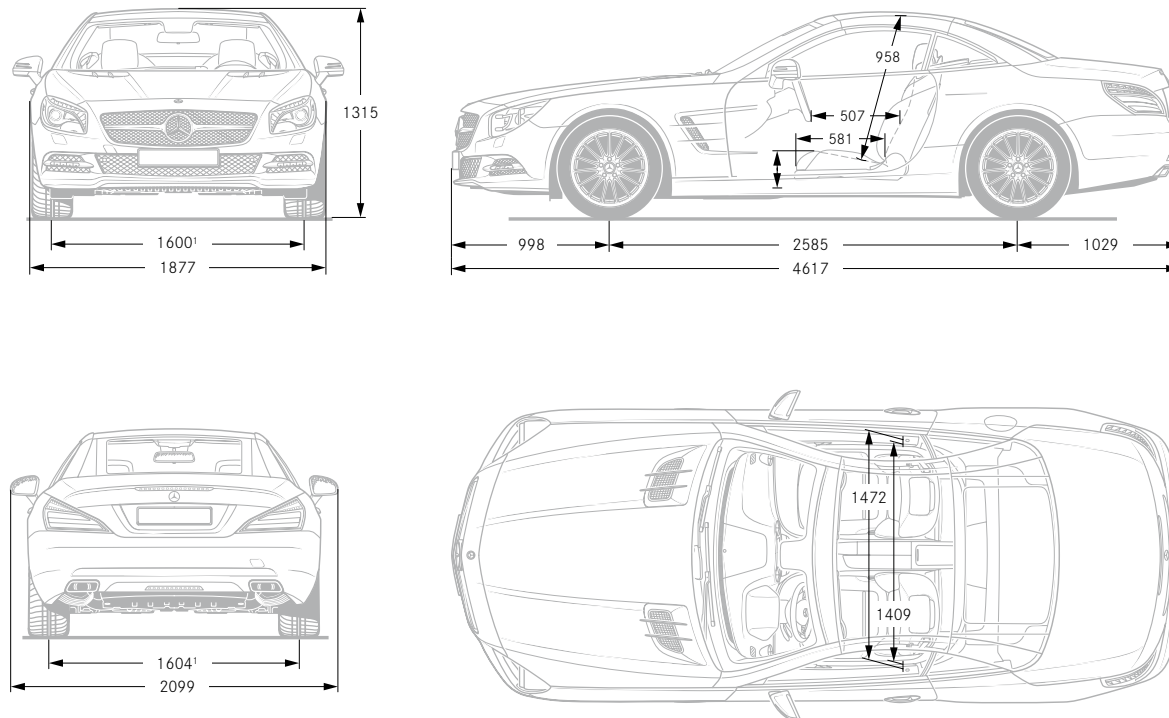

## Paintwork.

The paint system developed by Mercedes-Benz includes one of the best clear coats on the automotive market and is a key factor behind the car's excellent value retention. Its secret is the exceptionally thick molecular structure, which makes the metallic or non-metallic clear coat more resistant and produces a longer lasting and visibly more intensive shine.

---

### Non-metallic paints (standard)

---

- 040 black
  - 149 polar white
  - 590 fire opal
- 

### Metallic paints (option)

---

- 183 magnetite black
  - 197 obsidian black
  - 526 dolomite brown
  - 755 tenorite grey
  - 775 iridium silver
  - 792 palladium silver
  - 890 cavansite blue
- 

### designo paints (option)

---

- 281 designo cerussite grey magno
  - 799 designo diamond white bright
  - 996 designo hyacinth red metallic
- 

Further individual designo paintwork finishes at your Mercedes-Benz dealer.

All dimensions in millimetres. The dimensions shown are mean values and apply to standard-specification, unladen vehicles.

<sup>1</sup> Carrying 2 people, each weighing 68 kg.

## Technical data.

	Petrol engines	
	SL 400	SL 500
No. of cylinders/arrangement	6/V	8/V
Total displacement in cc	2996	4663
Rated output <sup>1</sup> in kW (hp) at rpm	245 (333)/5250-6000	320 (435)/5250
Rated torque in Nm at rpm	480/1600-4000	700/1800-3500
Acceleration from 0 to 100 km/h in s	5.2	4.6
Top speed, approx. in km/h	250 <sup>4</sup>	250 <sup>4</sup>
Fuel consumption <sup>4</sup> in l/100 km		
Urban	10.2-9.8	12.8-12.7
Extra-urban	6.2-5.9	7.1-7.0
Combined	7.7-7.3	9.2-9.1
CO <sub>2</sub> emissions <sup>4</sup> in g/km combined	179-172	214-212
Emission class <sup>5</sup>	Euro 6	Euro 6
Efficiency class	C	E
Tank capacity in l/incl. approx. reserve	65/8.0	65/8.0
Boot capacity in l		
With the roof closed	504	504
With the roof open	364	364
Turning circle diameter in m	11.04	11.04
Kerb weight <sup>6</sup> in kg	1730	1785
Perm. GVW in kg	2110	2165

<sup>1</sup> Figures according to Directive 80/1269/EEC in the currently applicable version. <sup>2</sup> AMG Driver's Package. <sup>3</sup> Electronically governed. <sup>4</sup> The figures shown were obtained in accordance with the prescribed measuring process (Directive [EC] 715/2007 in the currently applicable version). The figures are not based on an individual vehicle and do not constitute part of the product offer; they are provided solely for the purposes of comparison between different vehicle models. <sup>5</sup> Figures only valid within the European Union. <sup>6</sup> Figures in accordance with 92/21/EC in the version 95/48/EC (kerb weight with fuel tank 90% full, driver, 68 kg, and luggage, 7 kg) for standard-specification vehicles. Optional equipment and accessories will generally increase this figure and reduce the payload accordingly. Further technical data can be found at [www.mercedes-benz.com](http://www.mercedes-benz.com)

	<b>AMG engines</b>	
	<b>SL 63 AMG</b>	<b>SL 65 AMG</b>
No. of cylinders/arrangement	8/V	12/V
Total displacement in cc	5461	5980
Rated output <sup>1</sup> in kW (hp) at rpm	430 (585)/5500	463 (630)/4800
Rated torque in Nm at rpm	900/2250-3750	1000/2300-4300
Acceleration from 0 to 100 km/h in s	4.2	4.0
Top speed, approx. in km/h	250 <sup>3</sup> , 300 <sup>2,3</sup>	250 <sup>3</sup> , 300 <sup>2,3</sup>
Fuel consumption <sup>4</sup> in l/100 km		
Urban	13.9	17.0
Extra-urban	7.6	8.4
Combined	9.9	11.6
CO <sub>2</sub> emissions <sup>4</sup> in g/km combined	231	270
Emission class <sup>5</sup>	Euro 5	Euro 6
Efficiency class	F	G
Tank capacity in l/incl. approx. reserve	75/14	75/14
Boot capacity in l		
With the roof closed	504	504
With the roof open	364	364
Turning circle diameter in m	11.1	11.1
Kerb weight <sup>6</sup> in kg	1845	1950
Perm. GVW in kg	2180	2210

Non-metallic paints

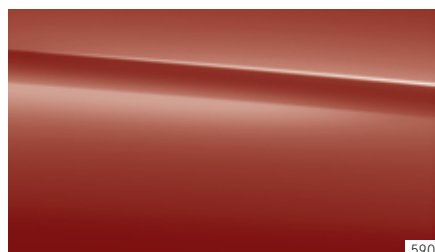
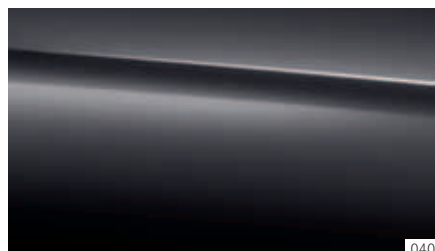

Metallic paints

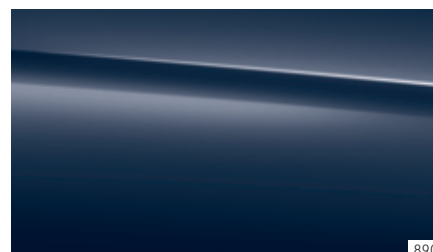
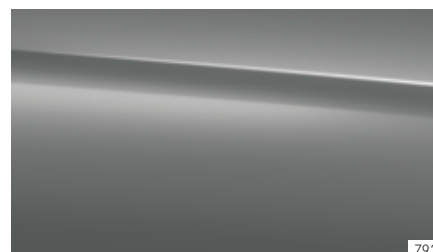
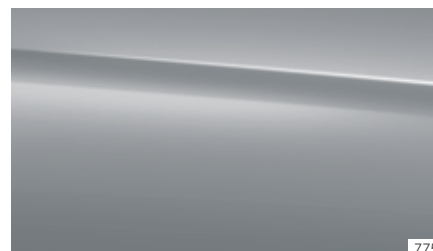
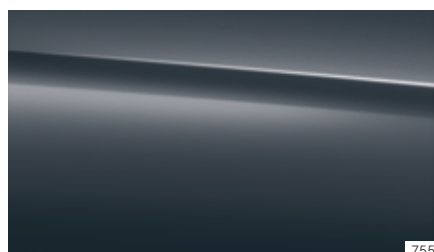
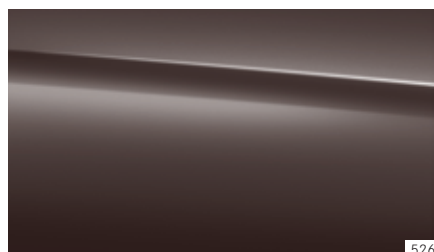
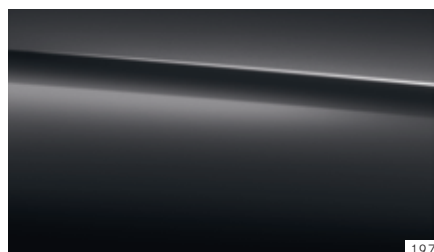
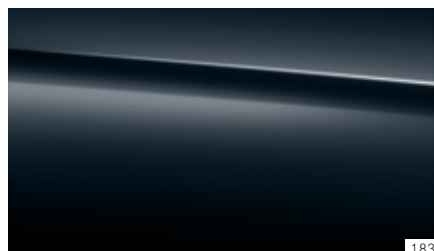

designo paints

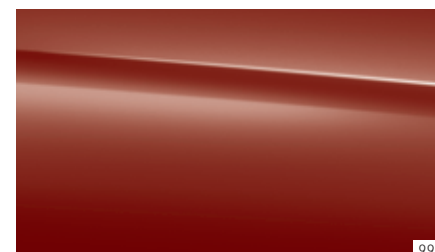
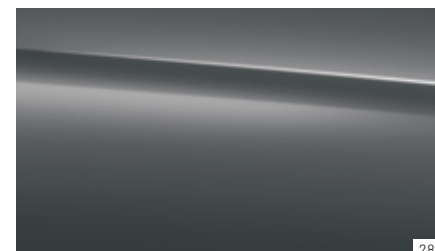

**Take-back of end-of-life vehicles.** At the end of its long life, you can return your SL-Class to us for environment-friendly disposal in accordance with the European Union (EU) End-Of-Life Vehicle Directive. But that day lies a long way off.

A network of vehicle take-back depots and dismantlers has been established to make it as easy as possible for you to return your vehicle. You can leave it at any of these points free of charge and, by doing so, make an important contribution to completing the recycling process and conserving resources.

For further information about the recycling and disposal of end-of-life vehicles, and the take-back conditions, please visit the national Mercedes-Benz website.

**Please note:** changes may have been made to the product since this brochure went to press (27.01.2014). The manufacturer reserves the right to make changes to the design, form, colour and specification during the delivery period, provided these changes, while taking into account the interests of the vendor, can be deemed reasonable with respect to the purchaser. Where the vendor or the manufacturer uses symbols or numbers to describe an order or the subject of an order, no rights may be derived solely from these. The illustrations may show accessories and items of optional equipment which are not part of standard specification. Colours may differ slightly from those shown, owing to the limitations of the printing process. This brochure is distributed internationally. It provides a general indication of the range of models, features, optional extras and/or colours available in various countries. Some of the models, features, optional extras and/or colours shown may not be available in your country or may only be available in combination with others. For current and more specific information in relation to the range of models, features, optional extras and/or colours available in your country, and their pricing, you should contact your nearest authorised Mercedes-Benz Passenger Car Dealer.

[www.mercedes-benz.com](http://www.mercedes-benz.com)