

# Aurion

Luxury in motion.



[toyota.com.au](http://toyota.com.au)



Oh what a feeling!

The slogan "Oh what a feeling!" is written in a white, cursive font. Above the text is a white silhouette of a person jumping with arms outstretched.



# Take a more luxurious drive.

It's apparent from the very first glance. The graceful posture, sleek lines and sophisticated styling make it clear that Aurion is truly a luxurious vehicle.

Step behind the wheel, and that sense of understated elegance is only enhanced – with the high quality finishes, the spaciousness, and the array of intuitive

technology that make driving a simple and seamless pleasure. And under the bonnet, the powerful and efficient V6 engine responds with utmost precision.

Aurion is in a class of its own, a vehicle for those who place a premium on sophistication, who value the truly refined, and wherever they go, choose to go in style.



Front cover: Presara model shown  
This page: Sportivo model shown





## Engineered to be enjoyed.

First impressions are powerful and when you first lay eyes on the Aurion, it's clear this is a car that will get you noticed in the best possible way. From every angle, the carefully crafted lines and sleek, confident profile speak not just to refined style, but intelligent aerodynamics.

Alloy wheels are available as standard across the Aurion range. On Sportivo, the head turning 18" black alloy wheels are as performance orientated as

they look, while the 17" alloy wheels on Presara are pure class in motion. And the silver metallic alloy wheels that are optional for Presara, are certain to shine out from the crowd.

Throughout the Aurion range – from the elegance of the Presara, to the athletic prestige of the Sportivo model, you'll find individual interpretations of luxury, and a sense of style that perfectly matches your own.

Presara model shown





Presara model shown





**Ivory Leather Accented interior** – Presara model shown



# The height of technological sophistication.

From the moment you step inside the Aurion you're enveloped in luxury. It starts with the opulent interior, and extends right through to the array of clever technologies, such as the keyless Smart Entry and Start system, and the clever electric rear sunshade<sup>1</sup> that provides shade and protects from the heat and sun.

When it comes to sound, Aurion delivers, with an audio system highlighted by an impressive 6.1" audio display screen. Choose the Presara and you'll enjoy the JBL premium audio system with 7" screen display complete with Digital Radio (DAB+)<sup>2</sup>, Satellite Navigation<sup>3</sup> and SUNA™ Traffic Channel<sup>4</sup>. Then connect your smartphone with Toyota Link<sup>5</sup> to find fuel, accommodation, plan trips, receive real time advice, easy-to-follow directions and the latest weather information, all delivered through the audio unit.

Need to make or receive a phone call or change your music? Aurion makes that a seamless experience too – with steering wheel mounted audio controls, and Bluetooth®<sup>6</sup> connectivity for audio streaming and hands-free mobile calls. Then settle back and enjoy an easier drive thanks to voice control being fitted as standard across the Aurion range.

- A. Electric rear sunshade – Sportivo model shown
- B. USB input for audio devices – Presara model shown
- C. Luxurious finishes – Presara model shown
- D. Satellite Navigation – Presara model shown
- E. Smart Start Button





# For the true pleasure of driving.

Every last detail of the Aurion has been designed for comfort, convenience and pleasure. From the dual-zone climate control air conditioning, ensuring you and your passengers are always at the perfect temperature, to the acoustic insulation technology that blocks outside noise and keeps the cabin whisper quiet, Aurion is a genuine delight to drive.

You'll notice immediately the sense of space – with added legroom in the back seats created through clever sculpting of the door trims and seatbacks. Specially designed for comfort, the rear seats have been shaped for optimum sitting posture, and the driver's seat is equipped with advanced lumbar support for extra comfort, even on those long drives.

Right before your eyes, the twin dial combimeter glows in luxurious blue and white tones, while the full colour 4.2" Multi Information Display (MID) delivers a brighter, sharper view of all you need to know – including ECO Drive data of your journey to help you drive with greater efficiency. And with rain sensing wipers on the Presara, the Aurion is a pleasure to drive even in adverse conditions.

**A. Optitron Combimeter with Multi Information Display (MID)**

**B. Rain sensing wipers – Image for illustration purposes**



A.



B.



# There's no playing it safe on safety.

There's nothing quite so important as the safety of everyone on board. Even on the shortest of trips, it's reassuring to know that you're buckling up in a vehicle awarded the maximum 5-star ANCAP safety rating.

Aurion boasts a comprehensive range of active and passive safety features to help you steer clear of trouble. From Anti-lock Braking System (ABS) to Brake Assist (BA), Traction Control (TRC) to Electronic Brake-force Distribution (EBD), Aurion's intelligent braking system will ensure more control and more stopping power. And with the addition of Vehicle Stability Control (VSC), you can brake through corners with confidence. A reversing camera<sup>7</sup> with moving guidelines plus front and rear parking sensors are standard across the range to help you manoeuvre safely into tight spaces. On Presara, Blind Spot Monitor<sup>7</sup> (BSM) uses radars to inform drivers if vehicles are present in their blind spots and the Rear Cross Traffic Alert<sup>7</sup> (RCTA) uses the same sensors to warn you of approaching traffic when reversing out of a parking space.

With the extra safety of seatbelt warning indicators across the range, you can enjoy peace of mind behind the wheel. And should a collision ever occur, you and your passengers will be protected from every direction with seven SRS airbags that includes driver's knee protection.

A. Seven SRS airbags – Image for illustration purposes

B. Traction Control (TRC) and Vehicle Stability Control (VSC) – Image for illustration purposes



A.

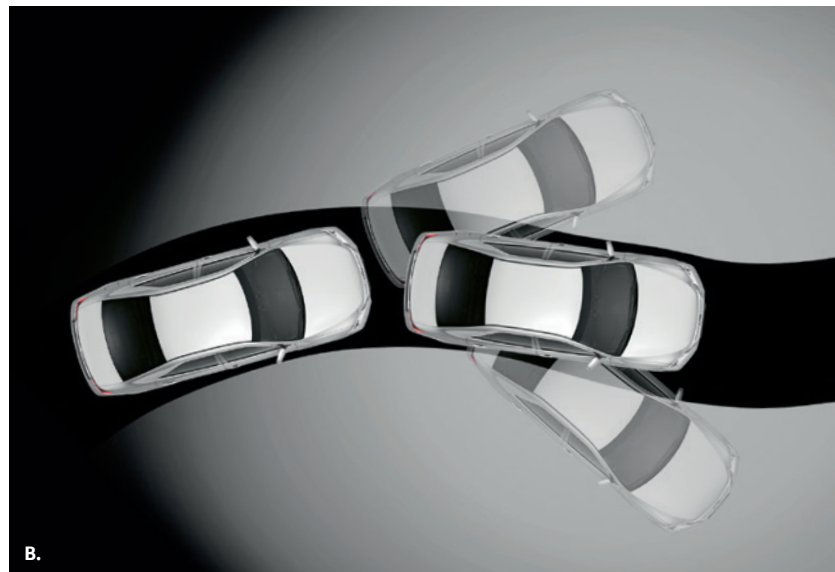

B.





3.5 litre Dual VVT-i V6 engine



## Superior performance, delivered powerfully.

Beneath the sleek lines of Aurion's bonnet you'll find an advanced 3.5 litre Dual VVT-i V6 engine capable of an impressive 200kW. Highly responsive, and smoothly delivered, it's a sense of power and poise that brings enjoyment to even the most mundane journeys. And it's all achieved with a combined fuel efficiency of just 9.3L/100km<sup>8</sup>.

But the performance doesn't stop under the bonnet. The suspension has been specifically tuned to improve driving performance and enhance the handling as well as being matched to bring out the best in the 18" alloy wheels, standard on the Sportivo grade. Shift gears with ease, with a smooth and efficient automatic 6-speed sequential shift transmission. Plus, in Sportivo, you'll enjoy quick response sports paddle-shift technology, for faster gear changes and a more exciting, dynamic drive.



Quick response sports paddle-shift – Sportivo model shown



# Every style of luxury.

From the effortless excellence of the AT-X, to the uncompromising class of the Presara, to the ultimate sports luxury of the Sportivo, there's an Aurion for every taste, and every style.



## AT-X

Big on comfort and style, Aurion AT-X includes:

- 3.5 litre V6 petrol engine
- 200kW power output
- 6-speed sequential shift transmission
- 16" alloy wheels
- Dual exhaust
- Driver and passenger's vanity mirror illumination
- Acoustic windshield
- Driver's seat – electrically adjustable with lumbar support
- Exterior mirrors with side indicators
- Dual-zone climate control air conditioning
- Cruise control
- Multi Information Display (MID) with 'ECO' indicator
- Optitron Combimeter
- Steering wheel mounted controls with Bluetooth<sup>®6</sup>
- AUX + USB input with iPod<sup>®9</sup> connectivity
- Toyota Link<sup>5</sup>
- 6.1" screen audio display, single CD player, AM/FM tuner
- Smart Entry and Start system
- Electric Power Steering (EPS)
- Auto-on/off headlamps
- Anti-lock Braking System (ABS) with Electronic Brake-force Distribution (EBD) and Brake Assist (BA)
- Vehicle Stability Control (VSC) and Traction Control (TRC)
- Reverse camera<sup>7</sup> and Back Guide Monitor with dynamic lines
- Front and rear parking sensors



## Sportivo

The ultimate in sports luxury, Sportivo includes all of the features of AT-X, as well as:

- Quick response sports paddle-shift
- Sports suspension
- 18" black alloy wheels
- Sports body kit including front spoiler and side/rear skirts
- Sports grille
- Front fog lamps
- Sports designed front seats
- Sports pedals
- Premium 3-spoke steering wheel
- Electric rear sunshade





## Presara

The ultimate in sophistication and uncompromised style, Presara includes all of the features of AT-X, as well as:

- 17" alloy wheels
- Rear lip spoiler
- Leather Accented interior and premium door trim
- Driver's seat memory
- Front scuff plates
- Chrome door handles
- Premium steering wheel
- Moonroof – glass tilt and slide
- LED headlamps and front fog lamps
- Automatic high beam
- Rain sensing wipers
- JBL premium audio with 7" screen display, Digital Radio (DAB+),<sup>2</sup> Satellite Navigation<sup>3</sup> and SUNA™ Traffic Channel<sup>4</sup>
- Electric rear sunshade
- Blind Spot Monitor<sup>7</sup> with Rear Cross Traffic Alert<sup>7</sup> and Lane Departure alert<sup>7</sup>

# Now to make it yours.

To give your own personal touch to your Aurion, we've selected a palette of eight dynamic colours for you to choose from.



A.



B.



C.



D.



E.



F.



G.



H.

- A. Indigo<sup>10</sup> 8W6
- B. Diamond White 061
- C. Crystal Pearl<sup>10</sup> 070
- D. Silver Pearl<sup>10</sup> 1F7
- E. Magnetic Bronze<sup>10</sup> 4S2
- F. Graphite<sup>10</sup> 1G3
- G. Wildfire<sup>10</sup> 3R3
- H. Eclipse Black<sup>10</sup> 218



# The finishing touches.

To complement your sense of style, each Aurion model comes with its own range of premium finishes and trims. Whether you prefer the sports-inspired Black and Raizen Leather Accented on Sportivo, or the Ivory or Black Leather Accented seats on the Presara model, you'll love every inch of your Aurion.

## Interior Seat Trim

- A. Black Shadowflex Fabric
- B. Black Sports Fabric
- C. Ivory Leather Accented
- D. Black Leather Accented
- E. Black and Raizen Leather Accented

## Interior Finish

- F. Silver
- G. Dark woodgrain-look
- H. Sports Mesh

## COLOUR GUIDE

Grade	Interior Seat Trim	Interior Finish	Diamond White	Crystal Pearl <sup>10</sup>	Silver Pearl <sup>10</sup>	Graphite <sup>10</sup>	Magnetic Bronze <sup>10</sup>	Wildfire <sup>10</sup>	Indigo <sup>10</sup>	Eclipse Black <sup>10</sup>
<b>AT-X</b>	Black Shadowflex Fabric (FA20)	Silver	•		•	•	•		•	•
<b>Sportivo</b>	Black Sports Fabric (FC20)	Sports Mesh	•		•	•		•	•	•
<b>Sportivo (optional)</b>	Black and Raizen Leather Accented (LB21)	Sports Mesh	•		•	•		•	•	•
<b>Presara</b>	Ivory Leather Accented (LA00) or Black Leather Accented (LA20)	Dark woodgrain-look		•	•	•	•		•	•

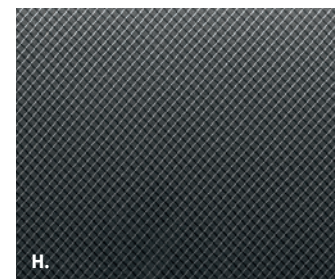
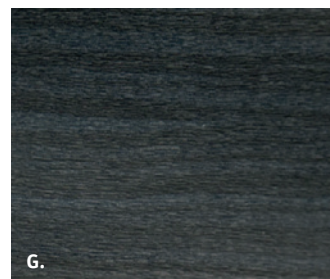
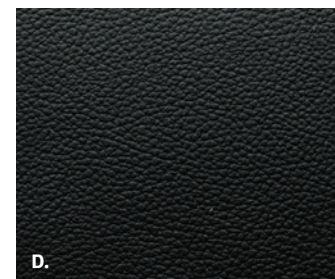
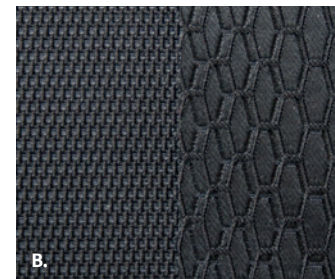
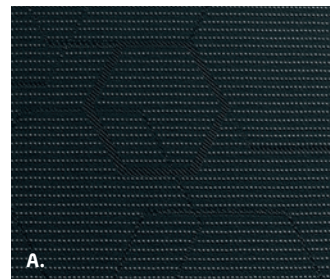



Ivory leather accented interior shown





AT-X model shown

# Toyota Genuine Accessories

- A. **Bonnet Protector and Headlamp Covers**  
(Sold separately)
- B. **Slimline Weathershields**
- C. **Door Handle Protection Film**
- D. **Front Fabric Seat Covers**  
Not compatible with Leather  
Accented seats
- E. **Bootliner**



A.



B.



C.



D.



E.



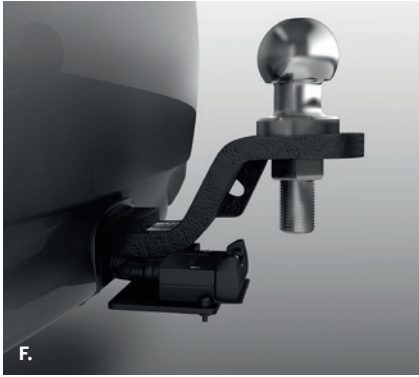

F.



G.



H.



I.



J.

- F. Towbar, Towball and Trailer Wiring Harness<sup>11</sup>**  
(Sold separately)
- G. Carpet Floor Mats**  
Front and rear set  
(Front set shown)
- H. Roof Racks**
- I. 17" Alloy Wheels<sup>12</sup>**
- J. Mudguards**

MECHANICAL SPECIFICATIONS				
<b>Engine</b>	Engine code and description	2GR-FE 3.5 litre V6 petrol engine		
	Valve mechanism	24-valve Double Overhead Camshaft (DOHC), with Dual Variable Valve Timing with intelligence (VVT-i)		
	Max power (kW/rpm)	200kW @ 6200rpm		
	Max torque (Nm/rpm)	336Nm @ 4700rpm		
	Bore x Stroke	94.0 X 83.0mm		
	Compression ratio	10.8 : 1		
<b>Fuel</b>	Fuel – fuel type octane no. (minimum recommended)	91 RON unleaded petrol		
	Fuel economy – ADR81/02 combined cycle <sup>8</sup>	9.3L/100km		
	Emissions – combined CO <sub>2</sub> <sup>8</sup>	215g/km		
<b>AURION MODEL</b>		<b>AT-X</b>	<b>SPORTIVO</b>	<b>PRESARA</b>
<b>Transmission</b>	Transmission	6-speed automatic transmission with sequential shift		
	Quick response sports paddle-shift with sports mode		•	
<b>Steering, Brakes and Suspension</b>	Tilt and reach adjustable steering wheel	•	•	•
	Electric Power Steering (EPS)	•	•	•
	Brakes – front ventilated disc and rear solid disc	•	•	•
	Suspension – front – MacPherson strut type with stabiliser bar	•	•	•
	Suspension – rear – dual link type with stabiliser bar	•	•	•
	Sports suspension		•	Optional
	Park brake – pedal type	•	•	•
<b>Wheels</b>	Design and style	10-spoke 16" alloy	5-spoke 18" sport alloy	15-spoke 17" alloy
	Temporary spare wheel	Alloy	Alloy	Alloy
	Tyre size	215/60 R16	225/45 R18	215/55 R17



AURION MODEL		AT-X	SPORTIVO	PRESARA
<b>Dimensions<sup>13</sup> and Weights</b>	Overall length (mm)	4835	4855	4835
	Overall width (mm)	1825	1825	1825
	Overall height (mm)	1470	1470	1470
	Wheelbase (mm)	2775	2775	2775
	Kerb to kerb turning circle (mm)	11000	11000	11000
	Vehicle kerb weight (kg) <sup>14</sup>	1505-1525	1525-1555	1530-1550
	Gross vehicle weight rating (kg) <sup>15</sup>	2100	2100	2100
	Gross trailer weight, braked/unbraked (kg)	1600/500	1600/500	1600/500
<b>Capacities</b>	Fuel tank capacity (L)	70	70	70
	Seating capacity	5	5	5
<b>Exterior</b>	Dual exhaust	•	•	•
	Exterior door handles colour	Body colour	Body colour	Chrome
	Electrically adjustable exterior mirrors with side indicators	•	•	•
	Rear garnish and rocker molding colour	Body colour	Body colour	Chrome
	Exterior mirrors with automatic dipping in reverse			•
	Sports grille	•	•	
	Sports body kit including front spoiler and side/rear skirts		•	
	Front fog lamps		•	•
	LED headlamps			•
	Auto-on/off headlamps	•	•	•
<b>Interior</b>	Smart Entry and Start system	•	•	•
	Dual-zone automatic climate control air conditioning	•	•	•
	Power windows – front and rear	•	•	•

AURION MODEL		AT-X	SPORTIVO	PRESARA
<b>Interior</b> <i>continued</i>	Acoustic windshield	•	•	•
	Electric rear sunshade		•	•
	Electro chromatic rear-view mirror			•
	Driver and passenger's vanity mirror illumination	•	•	•
	Rain sensing wipers			•
	Cruise control	•	•	•
	Premium steering wheel		•	•
	Front scuff plates		•	•
	Sports pedals		•	
	Driver's seat – electrically adjustable with lumbar support	•	•	•
	Front passenger seat – electrically adjustable		•	•
	Driver's seat memory			•
	Sports designed front seats		•	
	60/40 split fold rear seats	•	•	•
	Moonroof – glass tilt and slide			•
<b>Instruments and Controls</b>	Multi Information Display (MID) including Trip A & B odometer (km), outside temperature (°C), fuel range (km), fuel consumption (L/100km) <sup>§</sup> average speed (km/h)	•	•	•
	Automatic high beam			•
	Optitron Combimeter	•	•	•
<b>Storage</b>	Lockable glove box	•	•	•
	Centre console with sliding lid and storage recess x 2	•	•	•
	Sunglass holder – front overhead console	•	•	•
	Door pocket – driver and front passenger	•	•	•
	Seat back storage pocket – behind passenger seat	•	•	•
	Beverage holders – 2 x front, 2 x front door pocket, 2 x rear armrest, 4 x rear door pocket	•	•	•



AURION MODEL		AT-X	SPORTIVO	PRESARA
<b>Entertainment</b>	6.1" screen audio display, single CD player, AM/FM tuner	•	•	
	JBL premium audio with 7" screen display, Digital Radio (DAB+); <sup>2</sup> Satellite Navigation <sup>3</sup> and SUNA™ Traffic Channel <sup>4</sup>		Optional	•
	3.5mm AUX + USB input with iPod® <sup>9</sup> connectivity	•	•	•
	Surround sound speakers	6	6	10
	Steering wheel mounted audio controls	•	•	•
	Toyota Link <sup>5</sup>	•	•	•
	Hands-free Bluetooth® <sup>6</sup> with media streaming	•	•	•
<b>Safety</b>	Blind Spot Monitor <sup>7</sup> (BSM)			•
	Rear Cross Traffic Alert <sup>7</sup> (RCTA)			•
	Anti-lock Braking System (ABS) with Electronic Brake-force Distribution (EBD) and Brake Assist (BA)	•	•	•
	Vehicle Stability Control (VSC) and Traction Control (TRC)	•	•	•
	Lane Departure Alert <sup>7</sup> (LDA)			•
	Reversing camera <sup>7</sup> with back guide monitor	•	•	•
	Front and rear parking sensors <sup>7</sup>	•	•	•
	Child seat anchorage points x 3	•	•	•
	Seven SRS airbags – dual front, front side and full length curtain airbags and driver's knee airbag	•	•	•
	Seatbelt warning buzzer and lights for all occupants	•	•	•
3-point seatbelt for all occupants (driver and front passenger with pre-tensioner and force limiter)	•	•	•	
<b>Security</b>	Immobiliser	•	•	•
	Panic alarm on remote	•	•	•
	Remote central locking including boot release on remote	•	•	•
	Speed sensing auto door lock	•	•	•
<b>Options<sup>16</sup></b>	5-spoke 18" sport alloy wheels			•
	Moonroof – glass tilt and slide		•	
	Premium audio with Satellite Navigation <sup>3</sup> and sports Leather Accented seats		•	
	Premium audio with Satellite Navigation <sup>3</sup> , sports Leather Accented seats and moonroof		•	

# The Toyota Advantage.

Every Toyota gives you a lifetime of advantages. That's what makes it a Toyota. You'll enjoy legendary Toyota value from the moment you drive away, and you'll continue to appreciate the quality, safety and innovation that's engineered into each model, every day you drive.



## A smarter way to buy.

Toyota Access is an easy and flexible way to put you in complete control when you're buying a new car.<sup>17</sup> Drive out of the Dealership with complete confidence about the road ahead and drive back in just a few years later with more options at your disposal than ever before. Whatever stage you're at in life, Toyota Access puts you in the driver's seat with ongoing flexibility and assurance. To discover Toyota Access for yourself visit [toyota.com.au/access](http://toyota.com.au/access)



## Finance to get you going.

Sometimes you need just a little help to get up and running. Toyota Finance<sup>20</sup> can offer you a wide range of vehicle financing. With Toyota Finance, you'll have the peace of mind knowing that you're dealing with one of Australia's leading vehicle finance corporations with over 30 years experience in the Australian market. And with a range of flexible products and services to suit almost every need and circumstance, Toyota Finance can help find the right package for you or your business.



## Capped price servicing.<sup>18</sup>

When you buy a new Toyota, you don't have to worry about unexpected service costs. Every Toyota comes with a low, capped price service cost for a set number of years/kilometres. Pay the same low capped price from one eligible logbook service to the next for up to four years or 75,000km, whichever occurs first (including Genuine parts, labour and fluids). Your Aurion will be serviced by Toyota trained technicians who have full, specialised knowledge of your particular model. For the full benefits consult a Toyota Dealer or visit [toyota.com.au/advantage](http://toyota.com.au/advantage)



## Even more protection.

Take out our Comprehensive Motor Vehicle insurance and you'll get a policy packed with a great range of benefits including:

- Choice of agreed value or market value
- New vehicle replacement cover for Toyota vehicles damaged beyond repair up to 3 years/100,000km<sup>21</sup>
- Genuine Parts Promise
- Quality Repair Guarantee

And our Toyota Insurance Factory Approved Extended Warranty Insurance has been designed to provide you with protection for your vehicle that continues after your Toyota New Vehicle Warranty ends, giving you extra peace of mind.



## We've got your back.

Every new Toyota is built to exceptional standards, which is backed by a three year/100,000km<sup>19</sup> warranty, giving you the peace of mind to feel confident for years to come. In the unlikely event that you need them, every Toyota Service Centre is committed to providing any warranty repairs you may need. They have the technology, the tools and the skilled personnel to keep your Toyota in excellent condition.



## Extend your peace of mind.

Whether it's changing a flat tyre, helping with lost keys or jump-starting a flat battery, with Toyota Extra Care Roadside Assist help is never more than a phone call away. Available 24 hours a day, seven days a week, every day of the year, it's designed to give you complete peace of mind, whatever your emergency.<sup>22</sup> With two levels of cover available, Toyota Extra Care Roadside Assist provides one of the most professional, reliable, and technologically advanced assistance networks in Australia.



# Disclaimers and Notice.

- 1 Presara and Sportivo models only.
- 2 Digital radio station coverage dependent on vehicle location.
- 3 Current navigation mapping database encompasses major capital and primary national road networks and offers some coverage in regional areas.
- 4 SUNA™ GPS Traffic Updates are only available in metropolitan Adelaide, Brisbane, Canberra, Gold Coast, Melbourne, Perth and Sydney; it operates from information provided by Intelomatics Australia and may not cover all road incidents and congestion. See [sunattraffic.com.au](http://sunattraffic.com.au) for details.
- 5 Toyota Link is available on certain vehicle models and grades only. Toyota Link services rely on data from the driver's compatible mobile phone and information provided by third parties. Availability is dependent on a number of factors, including the availability of third party information, mobile service, sufficient mobile data allowance and GPS satellite signal reception. Mobile usage is at the user's cost. Toyota Australia reserves the right to add, remove or modify applications. Further information is provided at [www.toyota.com.au/toyotalink](http://www.toyota.com.au/toyotalink)
- 6 The Bluetooth® word mark is owned by Bluetooth SIG, Inc. Not all devices will be compatible and functionality varies depending on the device.
- 7 Reversing Camera/Park Assist/Blind Spot Monitor/Front and rear sensors/Lane Departure Alert/Rear Cross Traffic Alert/Brake Assist is a driver assist device only and should not be used as a substitute for safe driving practices. The area into which the vehicle is driven must be visually monitored by the driver.
- 8 Fuel consumption and emissions will vary depending on driving conditions/style, vehicle conditions and options/accessories. Source of fuel consumption data: ADR81/02 combined (L/100km) for auto models.
- 9 iPod® and iPhone® are trademarks of Apple, Inc. Not all devices will be compatible and functionality will vary depending on the device.
- 10 Paint featured is an optional extra available at additional cost. Not all colours available on all models, see colour guide for details of availability.
- 11 Towing capacity is subject to regulatory requirements, towbar and vehicle design and towing equipment limitations. Ask your Dealer for Toyota Genuine Towbar capacity and availability details.
- 12 AT-X grade comes standard with 16" alloy wheels and will require new tyres (sold separately) for the accessory to be fitted.
- 13 Some vehicle dimension figures are approximate and vary due to options and accessory fitment.
- 14 Kerb, tare and payload weights are nominal and vary depending on options and accessories.
- 15 Gross Vehicle Mass (GVM) is the total permissible combined weight of the vehicle, including occupants, fuel and cargo.
- 16 Optional extra at additional cost.
- 17 Guaranteed Future Value (GFV) is the minimum value of your new Toyota at the end of your finance contract, as determined by Toyota Finance. If you decide to return your car to Toyota at the end of your term, Toyota Finance will pay you the agreed GFV amount which will be put against your final payment, subject to fair wear and tear conditions and agreed kilometres being met. The information provided is general in nature. You should seek your own financial advice to determine whether Toyota Access is appropriate for your individual circumstances. Terms and conditions, fees and charges apply. Toyota Access Guaranteed Future Value (GFV) products are available to approved customers of Toyota Finance, a division of Toyota Finance Australia Limited ABN 48 002 435 181, Australian Credit Licence 392536.
- 18 Maximum payable for standard scheduled logbook servicing (normal operating conditions) until first of four years or 75,000km (whichever occurs first), up to the first five services. Excludes Government & Rental vehicles. Contact your Toyota Dealer or go to [toyota.com.au/advantage](http://toyota.com.au/advantage) for other exclusions, eligibility and full details.
- 19 New Vehicle Warranty expires three years from date of first delivery or 100,000km, whichever occurs first. Refer to the warranty conditions. The New Vehicle warranty does not limit and may not necessarily exceed your rights under the *Competition and Consumer Act 2010*.
- 20 Toyota Finance is a division of Toyota Finance Australia Limited ABN 48 002 435 181, Australian Credit Licence No 392536.
- 21 Terms and conditions apply. This advice does not take into account any of your particular objectives, financial situation or needs. For this reason, before you act on this advice, you should consider the appropriateness of the advice taking into account your own objectives, financial situation and needs. Before making a decision about any of the insurance products, please refer to the current Product Disclosure Statement (PDS) for the relevant product available from participating Dealers, via the Toyota Insurance website at [toyotainsurance.com.au](http://toyotainsurance.com.au) or by calling 137 200. Toyota Insurance is a division of Aioi Nissay Dowa Insurance Co., Ltd. ABN 39 096 302 466 AFSL Number 254489 (Andia). The Insurer is Andia. Our insurance policies do not change or take away your rights under the Australian Consumer Law. Your right to claim under our policies for the benefits covered is in addition to other rights and remedies you have under the law in relation to your vehicle. However, you can choose to make a claim under any of our policies even if you have rights under the law.
- 22 Toyota Extra Care is administered by Toyota Finance, a division of Toyota Finance Australia Limited ABN 48 002 435 181, Australian Credit Licence 392536.

## IMPORTANT NOTICE – PLEASE READ:

Toyota Genuine Accessories are not applicable to all models/grades. Consider the mass of your load to ensure you will not exceed the maximum allowable individual axle capacity, Gross Vehicle Mass and/or Gross Combined Mass of the vehicle. Refer to the current Accessories brochure or visit [toyota.com.au](http://toyota.com.au) for details on warranty

Toyota Australia has used its best endeavours to ensure material is accurate at the time of printing. All information must be confirmed with your Toyota Dealer at the time of ordering, as specifications and details will change over time. Colours displayed are a guide only and may vary from actual colours. To the extent permitted by law, Toyota Australia will not be liable for any damage, loss or expense incurred as a result of

and [toyota.com.au/vehiclepayload](http://toyota.com.au/vehiclepayload) for details on vehicle payload, to help determine Accessories suitable for your vehicle. Accessory colours shown may vary from actual colour due to the printing process.

reliance on the information and photos contained in this material. Material distributed in Western Australia by or on behalf of Prestige Motors Pty Ltd (for vehicles) and by Eastpoint Pty Ltd (for parts/accessories). Toyota Australia makes no warranties regarding (and will not be liable for) accuracy of materials distributed in Western Australia. PART NUMBER: TYAURIONBRO. PROOF HQ: T2015-000713. PRINTED: MAY 2015. GTP1541



Sportivo model shown