



Why do so many people buy Volkswagens?



"Economy. That was the thing that sold me.

"This paper route is 175 miles long.

"If I'm going to make the grade on it, I've got to watch all my nickels and dimes.

"And driving a Volkswagen has cut my expenses in half."

Mr. Ed Coady
Lake Stevens, Washington

When Ed Coady started his newspaper route 15 years ago, he wasn't driving a Volkswagen.

But after he "saw a couple of them and heard about their economy," he checked into them.

And in 1959, when he bought one, he found it cut his costs in half.

Since then, he's been driving VWs.

In fact, he's owned 7. Including the '66 on the left.

Of course, the way Ed uses his VWs may be unique. But the reason he buys them isn't.

Economy is the biggest reason people everywhere buy Volkswagens.

Start with the VW's purchase price.

It's lower than most other cars'. So it can usually save you more than most other cars'.

In fact, compared to the prices of some cars, a new VW can save you enough to also buy a good used VW. And give you two cars for the price of one.

Running a VW can save you money, too.

It gets up to 27 mpg. On regular gas.

And takes only 5 pints of oil. Not quarts.
4 spark plugs. Not 6 or 8.

Where fees or taxes are based on vehicle weight or horsepower, it helps you save. Because it weighs only 1808 lbs. And has a 53-hp engine.

Many VW owners also save on insurance. Because some insurance companies find their costs are lower with VWs. So their premiums can be lower.

Some people even save when they stop running their VWs.

Because we don't change the way our car looks every year and because of the way it holds up from year to year, it often brings more in the end than cars that cost more in the beginning.

In fact, when you count up all the ways you can save with a VW, it's no wonder Ed saves 50%.

Of course, Ed realizes there is a cheaper way to deliver his papers:

"But I'm not about to start walking.

"That would take too long for this route.

"After all, I'm delivering a daily. Not a monthly."



The 1969 Volkswagen Sedan. It gets up to 27 mpg on regular gas—just like Ed Coady's '66 VW on the left. In fact, every time you run it, it makes an economy run.



"We've got the world's worst conditions on Antarctica.

"The temperature averages 0° (F) on the coast, and -30° (F) a short way inland. The terrain is nothing but snow and ice.

"Yet, we wanted a car there that any member of the expedition could hop into and drive off without a moment's hesitation.

"I don't think we had any choice but a Volkswagen."

Mr. Ray McMahon
Australian National Antarctic
Research Expedition
Rumdoodle Depot, Antarctica

Volkswagens have a reputation for going places most other cars can't.

Including Antarctica.

The Australian National Antarctic Research Expedition took one there in 1963. And found it was one car in the world that could conquer conditions on the bottom of the world.

The main reason: the VW engine.

It's air cooled.

So it couldn't freeze up. (Or boil over.)

In fact, during one blizzard the VW stood in temperatures well below -20° for 6 days. Then started without a tremble.

It also ran just about everywhere without a tremble. Because of where we put the engine:

In back. Above the drive wheels.

Some people who own conventional cars put cement blocks or sandbags there. And hope for

extra traction.

But by putting our 263-lb. engine there, the VW has extra traction. And goes through mud, sand, and snow while others are spinning their wheels.

In fact, after climbing a few ice slopes, Ray McMahon's Volkswagen became known as the "Red Terror." (Though it was no different than any other car we sold that year.)

Ray even remembers one trip across the ice where his VW "was used to tow a loaded sledge weighing about 450 pounds."

The going was a little slower than usual. But "it beat having to drive dog-sled teams."

Where's the "Red Terror" today?

Back in Australia.

After 12 months on Antarctica, she was retired.

And replaced by another car.

A '64 VW. That's still there.



We put our engine in back. So you get extra traction. And we cool it with air. So you won't freeze up or boil over. If you've ever boiled over in a water-cooled car, you'll like riding on air.



"When Howard bought the VW, our big car was supposed to become mine to get around in, and the VW his to commute in.

"But I tried the VW and found it's really fun to drive.

"I can even park it in spaces I didn't know existed.

"Now poor Howard's stuck with the big car. And the Volkswagen's mine."

Mrs. Howard V. Hoover
Greenwich, Connecticut

Sound familiar?

It might. Because there are thousands of two-car families in America where *his* VW has become *her* car once she's found it's easier and more fun to drive than their other car.

One big reason for this is the VW's small size.

It's only 13' long by 5' wide. Which makes it about 4' shorter and 1½' narrower than the average domestic.

So naturally it's easier to maneuver in traffic.

And as Mrs. Hoover learned, it's also easier to park. Even in spaces so small they weren't considered parking spaces until VWs found them.

The VW's short turning radius can come in handy, too.

In Atlantic City, it helped one lady outmaneuver two pursuing would-be bandits. And save an \$11,000 payroll that she was carrying.

She simply made a tight U-turn. That they couldn't.

Getting around is also fun because you get syn-

chronized shifting. In all 4 forward gears.

Each time you shift, it gives you a smooth quiet shift.

Of course, if even synchronized shifting isn't smooth enough for you, maybe you'd like our new optional transmission.

It's just about automatic.

Like most automatics, it has a Low for starting out on steep hills. A Drive 1 for driving around town in all day. And naturally, no clutch pedal.

But unlike most automatics, it has both a stick shift and an extra gear which acts like an overdrive. Drive 2.

Once you're cruising above 55 mph, you simply shift our stick into Drive 2. And save extra gas.

Of course, our new transmission may be a problem for the man of the house.

Because if the lady of the house thought his VW was fun to drive before, now look at how much more fun it is.

With an automatic stick shift.



Many people also like our optional sunroof. It's metal outside and leatherette inside. Closed, it keeps weather out. But open, it lets indoors all the outdoors you want. See for yourself. Take one for a test drive. And open her up.



"It's an amazing car. Because on the outside, it looks very small. But inside, it's very comfortable. Especially in front."

"I'm 6'. And I have no problem with headroom or legroom."

"In fact, I think it has enough room for the tallest man."

"And if the seats are comfortable, if you have enough headroom and legroom—what more can you want?"

Mr. Rahmatullah Asifi
Attache
Royal Afghan Embassy
Washington, D.C.

In the movies, most diplomats ride around in long sleek limousines.

But in real-life Washington, D.C., they often ride around in Volkswagens.

In fact, in Washington more DPL license plates are attached to VWs than to any other car.

How come?

One reason is that even though a VW Sedan is 7' shorter than most limousines, its front-seat passengers get just as much headroom and legroom as in most limousines.

"The front seats themselves are very comfortable," according to Mr. Asifi.

They're bucket seats. That adjust back and forth independently on tracks. And have backrests that adjust to 3 positions and lock in place.

The backseat is comfortable, too.

It can easily seat 2 adults.

Of course, no one travels without luggage. So we've put a 5 cu. ft. luggage compartment under

the front hood. And a 5 cu. ft. luggage well behind the backseat.

Together, they let you put about as much luggage in the bug as in most domestic compacts. Which average about 2' longer outside.

Once you yourself get into the bug, you'll see we've already put a lot into it. As standard equipment.

For instance, we've put in a fresh-air ventilation system. Plus a deep-dish steering wheel. A telescoping steering column. A breakaway day/night rear-view mirror. Built-in headrests on the front seats. Seat belts on both the front and back seats. And extra padding all around.

In fact, when you consider that we make our car more comfortable every year, it's no wonder that more and more diplomats buy it every year.

Of course, no matter how many diplomats drive Volkswagens in real life, you'll probably still see them riding in limousines in the movies.

But then, that's show biz.



The VW's 2 luggage compartments can hold 4 good-size suitcases. Plus a few small bags. But if you want even more space, just fold down the bug's backseat backrest. And you can use just about all of its back space as luggage space.



"When we bought this farm, we had no tractor or horse. So I started using my VW to patrol it.

"I'd go up and down hills, through ditches and buckbrush —and nothing seemed to bother the VW.

"Well, one thing led to another, and pretty soon I was using the VW to herd cattle. And even to stretch barbed-wire fence.

"The way I figure it now—as long as I've got this VW, I don't need a tractor or a horse."

Mr. Richard Winkler
Pacific, Missouri

Is the VW finding itself a home on the range?

Maybe.

Richard Winkler isn't alone out there.

To the west, a fellow rancher uses a VW to ride herd on a thousand head of cattle.

Up north, another rancher has even used a VW to stop a stampede.

Why is the VW so popular out on the range?

Mainly because on its outside, it's designed for the outside.

For example, it has a 6" ground clearance. Which is high enough to clear most things you find on the range.

It also has a steel plate across its bottom. Which smooths out the things it doesn't clear.

In fact, all the rods and cables for the gearshift, clutch, accelerator, hand brake, and fuel line are enclosed in a steel tunnel that runs down the middle of the plate. So nothing can hurt them.

The plate also adds strength to the VW's body. So even stretching fence, as Richard Winkler does,

won't stretch the body out of shape. Or pull it out of line.

The body itself is welded together. Not bolted together. So even the roughest terrain can't shake it apart.

You won't get shaken apart either. Because the VW has independent torsion bar suspension on all 4 wheels.

When one hits a bump, none of the others feel it.

Of course, the VW isn't designed for the outside just on its bottomside.

On its topside, it gets an all-weather finish. Which "stands up beautifully," according to Richard Winkler.

And he leaves his VW out the year round.

Even after driving through buckbrush, he hasn't noticed any trouble with the finish.

"It's still the original paint."

In fact, the only trouble he had was a dented front hood.

And now that that's fixed, old paint rides again.

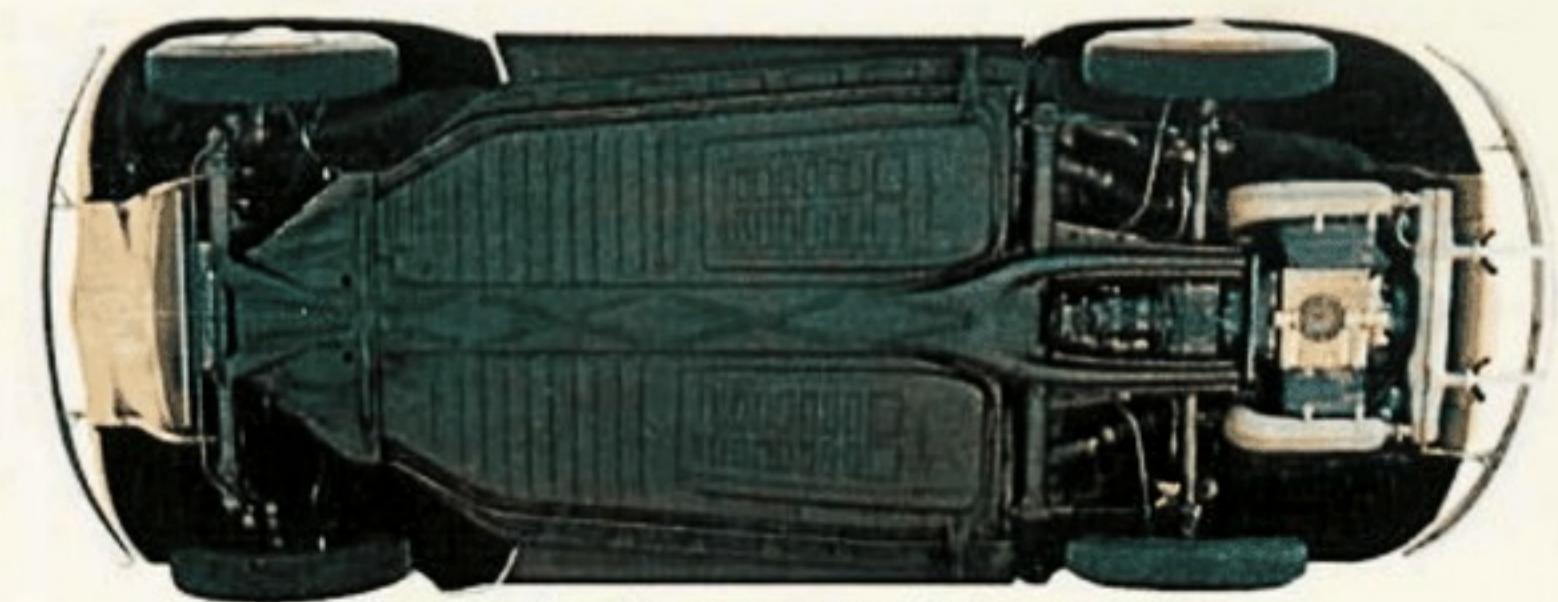

The steel plate that runs across the bottom of the VW is sealed to the rest of the VW. So water can't get up into the VW. And some of the stories you've heard about VWs floating, aren't just stories.



"I started buying them when I started as an actor.

"Today, I drive them out of loyalty."

Mr. Paul Newman
Beverly Hills, California

Paul Newman bought his first Volkswagen in 1953. Since then, he's owned 5. Including the '63 on the left.

Which kind of makes him a typical VW owner. Because when it's time for the typical VW owner to buy a new car, he usually buys another new VW.

Why such loyalty?

Maybe it's because people who started out liking the idea behind our car like the idea that we've remained loyal to the idea behind our car.

It's still the honest, sensible, economy car it started out to be 20 years ago. Even though we've made thousands of changes in it.

But that's because our changes have never been designed to make the car obsolete. Only to make it run better.

For instance, over the years we've increased the horsepower. Strengthened the clutch. Added a

dual brake system. And even enlarged the windows. Take our convertible top.

Once it was just canvas. Today it's vinyl outside. And leatherette inside. With a 1"-thick blanket of insulation in between.

Actually, over the years just about everything has changed. Except the way our car looks.

Even the way people look at it has changed.

In 1949, it brought a lot of laughs.

By 1959, it had a lot of people you'd never think would own one, owning one. Of course, with the ready comment that "it's our second car."

But today, there's nothing wrong with owning a VW. And just a VW.

And Paul Newman probably proves that best with his VW:

"It's my car.

"I drive it every place I go."



The Volkswagen Convertible's top really makes sense. It overlaps the windshield for a weathertight seal. And it'll never jam half way up or down because it's raised and lowered by a fool-proof device: You.



"We were on our way east, near Youngstown, when our VW broke down.

"It was evening. But once the local VW dealer knew we were stranded in a strange city, we got full emergency treatment.

"He got us a motel . . . took us there . . . even showed us where we could get breakfast in the morning. Then he worked all night on our car so we could have it right after breakfast.

"It's a privilege and a pleasure to have a breakdown with a Volkswagen."

Mr. Byron Bozarth
Mansfield, Ohio

The problem the Bozarth's ran into may have been unique.

But the service wasn't.

Most people actually tell us that one of the best things about owning a VW is VW service.

First of all, they find they don't need it often.

But when they do need it, they also find it's easy to find. Because wherever we sell VWs, we service VWs. (In all 50 states. Plus Canada, Mexico, and 137 other countries.)

They also find it's fast and economical.

One reason being the VW itself.

While it's made to hold together for a long time, it's also made to come apart in a short time.

For instance, we can remove an entire engine in just 38 minutes.

And that's important. Because the time we spend on your car is the money you spend on your car.

Another reason that work on a VW is fast and

economical is the man who works on a VW.

He's sort of a professional student. Always learning how to do the job faster and better.

When he first comes to us, no matter how much he knows about other cars, we send him to a VW training school. To learn all about our cars.

Then as we make changes in our cars, we make sure he knows about the changes.

Even our parts help keep the costs low.

Our hood is a hood. Our fender, a fender.

So if your fender ever gets smashed, you won't have to replace the whole side of your car. Just your fender.

And no matter what part you need, you'll never have to go looking for it in a junkyard.

Because we can get you a part to replace any part in any VW you own.

Even if you own one of the first 2 we sold in the United States. Back in 1949.

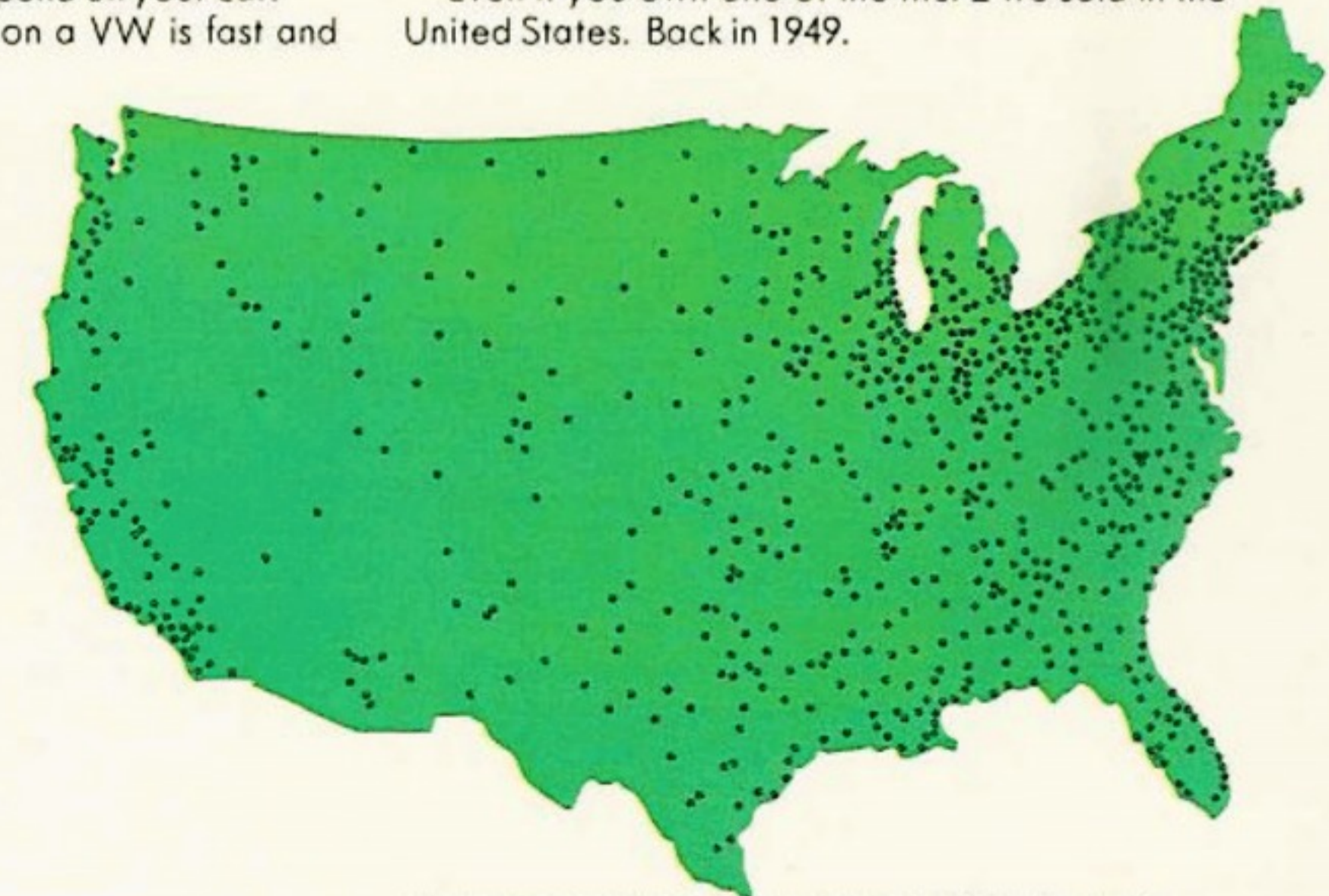

There are more than 1000 Authorized VW Dealers in the United States. So there's no problem finding VW service. Or parts—even for a new '69. Because before a dealer sells a new '69 out front, he has enough parts on top to build one in back.



Why do so many people buy Volkswagens?



Maybe it's word of mouth.

When most people have a good thing going, they want to share it with others.

Friends tell friends.

Neighbors tell neighbors.

Even relatives who haven't spoken to each other in years start speaking again.

And over the years, a lot of people must have listened to our story.

Because our first year, we sold only 2 cars.

But since then, we've sold 3 million.

What makes a Volkswagen a Volkswagen?

New things: Like our automatic stick shift, our electric rear-window defogger, and our steering/ignition lock.

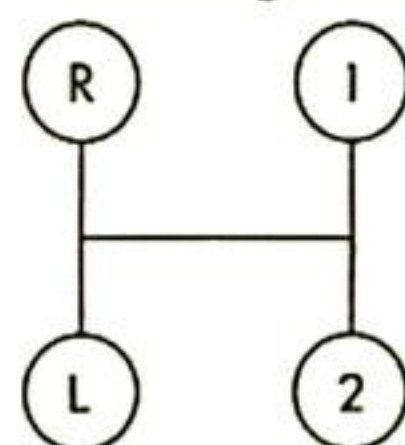

Our new optional transmission.

Our optional automatic stick shift, for example, is easier to use than it is to say.

Like most automatics, it has no clutch pedal. Put it in Drive 1, and you can just about drive around town all day without having to shift gears.

On the highway, above 55 mph, you shift just once. And that's into Drive 2.

It's like an overdrive. So it saves you gas.

Which, with us, is still the name of the game.

Our new electric rear-window defogger sounds complicated, too. But it isn't.

When the rear window begins to ice up or fog up, you simply flip a switch to the right of the steering column. And clean the window.

Of course, with all the improvements we've made over the years, it's no wonder that we've had to add our new steering/ignition lock.

You see, while once you couldn't give away a VW, now people actually try to steal them.

But our new lock should help stop that.

Because when you shut off the ignition and remove the key, it locks the front wheels in position.

So if a thief ever breaks in and jumps the wires, he'll probably wind up going in circles.

He may even wind up going straight.

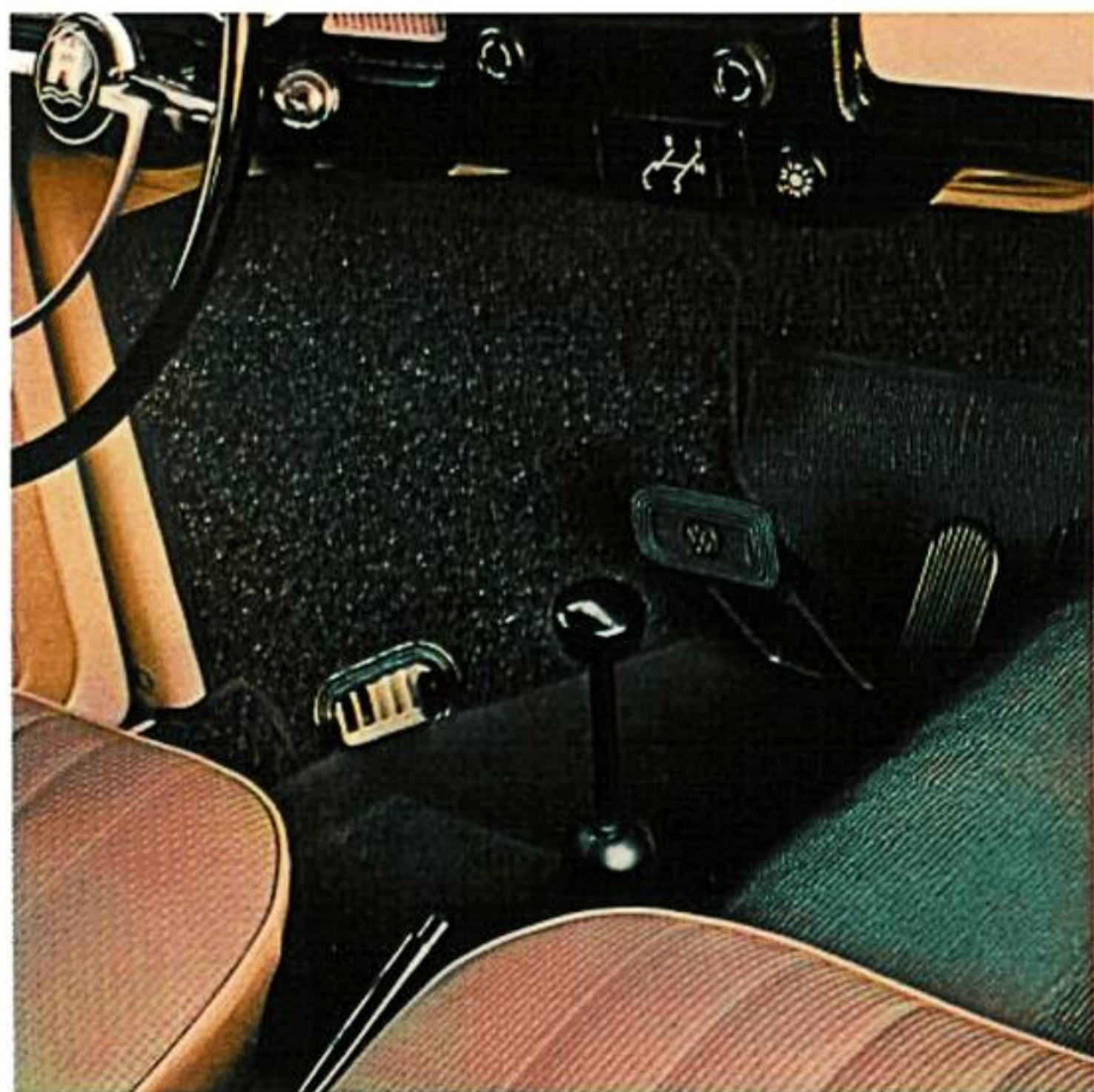

Tried and true things: Like our standard 4-speed synchromesh transmission, our air-cooled engine, or our sealed steel bottom.

Of course, just because they're tried and true things doesn't mean we're through with them. We're always working on them.

You see, our changes are never to make the bug obsolete. Just to make it run better.

Safety features. Including a deep-dish steering wheel and telescoping column, dual brake system, breakaway day/night rear-view mirror, extra padding, push-button door locks, safety belts, built-in front-seat headrests, and lockrest locks on both front and back seats.

Our fresh-air ventilation system is built into the top of the dash. And has separate controls for each person in front.

Our rear luggage compartment is 5 cu. ft. And can also hold 2 good-size suitcases. Plus a few small bags.

Our front luggage compartment is under the front hood. It's 5 cu. ft. And can easily hold 2 good-size suitcases. Plus a few small bags.

Two-speed windshield wipers. Plus windshield washers.

Our hand-assembled aluminum-magnesium engine sits above the drive wheels for extra traction. And because it's air-cooled, there's no radiator. So there's no bother with anti-freeze. And no chance of expensive radiator repair bills.

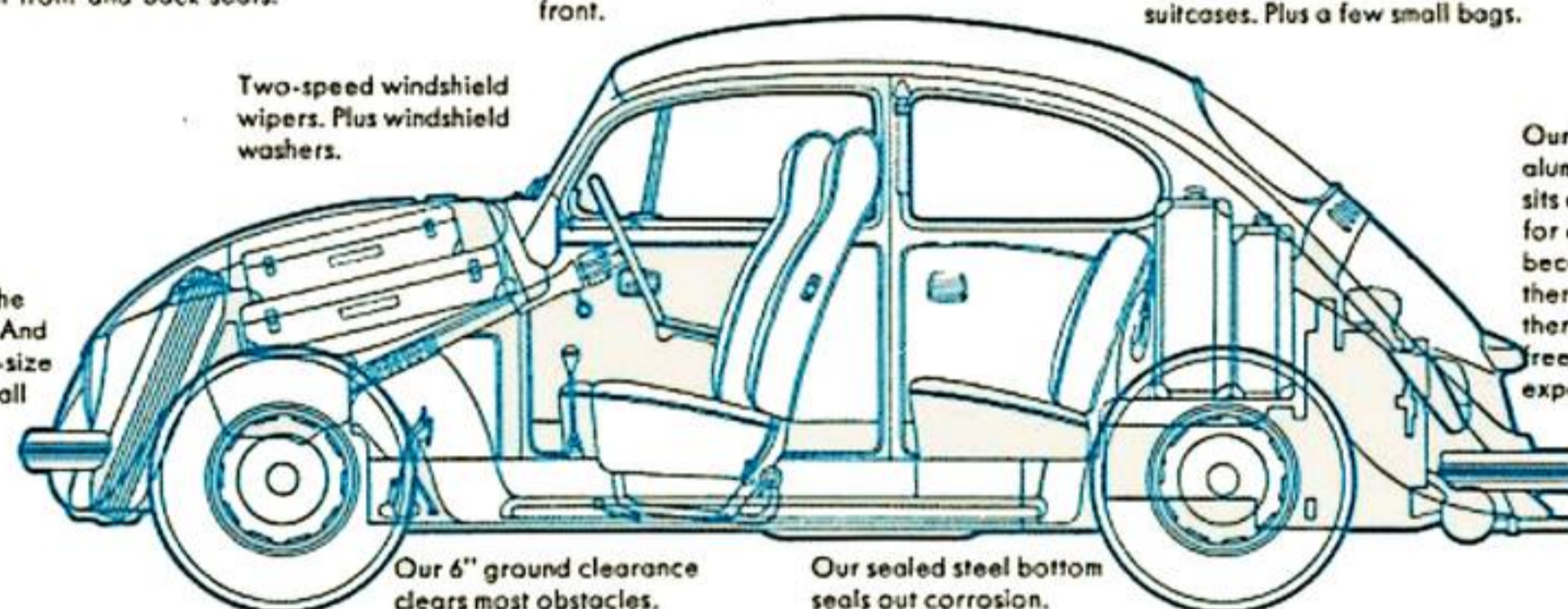

Our 6" ground clearance clears most obstacles.

Our sealed steel bottom seals out corrosion.

SPECIFICATIONS

Engine: 4-cylinder, 4-stroke O.H.V.-type VW rear engine. Cylinder arrangement: 2 pairs horizontally opposed. Valves: Overhead type. Bore: 3.27 inches. Stroke: 2.72 inches. Displacement: 91.10 cubic inches (1493 cubic centimeters). Compression ratio: 7.5:1. Maximum S.A.E. brake horsepower: 53 at 4200 rpm. Piston speed: 1811 ft./min. at 4000 rpm. Engine weight: 263 lbs. Lubrication: Pressure lubrication (gear-type pump) with oil cooler. Oil capacity: 5.3 U.S. pints. Fuel pump: Diaphragm type, mechanically operated. Carburetor: Solex downdraft carburetor with automatic choke. Air cleaner: Oil-bath type with thermostat-controlled preheating of intake air. Cooling system: Air cooling by fan, thermostatically controlled. Muffler: Dual exhaust.

Electrical System: Battery: 12 volts, 45 amp. hrs. Generator: 360 watts.

Standard Transmission: 4 forward speeds, 1 reverse. Synchromesh on all 4 forward gears. Gear ratios: 1st, 3.80:1; 2nd, 2.06:1; 3rd, 1.26:1; 4th, 0.89:1. Reverse: 3.61:1. Final Drive Gear ratio: 4.125:1. Oil capacity of transmission and final drive: 5.3 U.S. pints. Clutch: Single disk, dry.

Optional Transmission: 3 forward speeds, 1 reverse. Fluid coupling torque converter. Gear ratios: Low, 2.06:1; Drive 1, 1.26:1; Drive 2, 0.89:1; Reverse, 3.07:1. Maximum torque multiplication: 2.1:1. Differential ratio: 4.375:1. Oil capacity of transmission and final drive: 6.3 U.S. pints. Torque converter capacity: 7.6 pints.

Final Drive for Each Transmission: Power transmitted through spiral bevel gear, two-pinion bevel differential gear and rear axle shafts to rear wheels.

Performance: Fuel consumption: 27 miles per U.S. gallon (at half payload at a steady 3/4 of top speed

on level roads) with standard transmission, 25 mpg with optional transmission. Maximum and cruising speed: 78 mph with standard transmission, 75 mph with optional transmission.

Chassis: Frame: Tubular center section forked and welded on platform. Front axle: Independent suspension by 2 trailing arms on each side, horizontal torsion bars. 4 large rubber stops to prevent excessive wheel movement. Double-acting hydraulic telescopic shock absorbers. Stabilizer. Rear axle: Rubber mounted in subframe. Independent suspension by trailing arms, and diagonal links and rear axles, each with 2 universal joints. Rubber stops and shock absorbers as in front axle. Steering: Worm-and-roller type and divided tie rod. Hydraulic steering damper. Deep-dish steering wheel. Telescoping steering column. Turning circle: approx. 36 ft., 2.6 turns of steering wheel from lock to lock.

Body: 2 doors, each 37.4 inches wide, can be locked and unlocked from inside and outside. Windows: toughened safety glass. Windshield: double thick interlayer safety glass. Bucket seats: 2 in front, adjust back and forth in 7 positions. Backrests with built-in headrests, adjustable in 3 angles, lock automatically to prevent them from tilting forward.

Heating/Defrosting System: 5 outlets at the windshield, 2 openings at foot level in front, 2 in rear.

Fresh-air Ventilation System: 2 fresh-air vents at the windshield. Operating knobs on the dashboard.

Wheels: Disc-type with drop-center rim 4J x 15.

Tires: 5.60 x 15, tubeless.

Brakes: Dual hydraulic footbrake system operating on front and rear paired wheels. Mechanical handbrake operating on rear wheels.

Capacity of Luggage Compartments: Rear: 5 cubic feet. Front: 5 cubic feet.

Capacity of Fuel Tank: 10.6 U.S. gallons.



























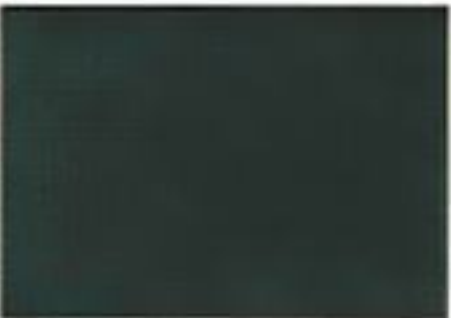





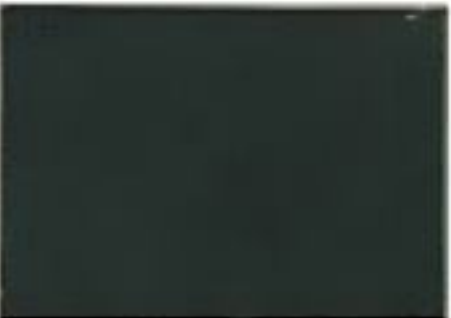





Dimensions in Inches: Wheelbase: 94.5. Track: front 51.6, rear 53.1. Length: 158.7. Width: 61.0. Height: 59.0.

| Weights (pounds): | Sedan | Convertible |
|-------------------|-------|-------------|
| Unladen weight: | 1808 | 1918 |
| Maximum load: | 838 | 728 |
| Gross weight: | 2646 | 2646 |

Standard Equipment: Includes padded dash, arm-rests (front) and sunvisors, 1 outside mirror, break-away day/night inside rear-view mirror, safety belts for all seats, dual braking system with dashboard warning light, combination headlight dimmer/turn signal fingertip control, electric rear-window defogger, non-repeat ignition/steering lock, 2-speed electric windshield wiper with pneumatic washer system, bucket seats with built-in headrests up front, 4-way emergency flashers, front-seat passenger grab handle, large door pocket, recessed door handles, 2 backup lights, courtesy light, ashtrays front and rear, assist straps, vinyl headlining, rubber floor mats, spare tire and wheel, tool kit, fold-down rear seat, variable intensity instrument lighting, side jacking ports, glove compartment, coat hooks (Sedans only), vanity mirror in right sunvisor (Convertibles only).

Optional Equipment and Accessories: Automatic stick shift transmission, leatherette upholstery (Sedans only), whitewall tires, hinged rear side windows, sliding steel sunroof, radio and antenna, rear speaker, air conditioner, cigarette lighter, vent shades, gravel guards, tissue dispenser, and more: ask your Authorized VW Dealer to show you his accessories line catalog.

The 1969 Volkswagen Colors

| Sedan | | | Convertible | | |
|---|---|---|---|--|--|
| Body | Cloth with Leatherette trim | Leatherette | Body | Convertible Top | Leatherette |
|  Savannah Beige |  Red |  Nut Brown |  Savannah Beige |  Black |  Black |
|  Cobalt Blue |  Platinum |  Cream White |  Cobalt Blue |  Silver Grey |  Cream White |
|  Black |  Platinum |  Red |  Poppy Red |  Black |  Black |
|  Royal Red |  Platinum |  Black |  Yukon Yellow |  Black |  Black |
|  Peru Green |  Platinum |  Cream White |  Diamond Blue |  Black |  Black- |
|  Diamond Blue |  Water Blue |  Black |  Toga White |  Black |  Black |
|  Toga White |  Red |  Red | | | |

OUR 2-YEAR/24,000-MILE WARRANTY. If the owner maintains and services the vehicle in accordance with the Volkswagen maintenance schedule and obtains a validation stamp on his Maintenance Card every twelve months, and if any part of a new Volkswagen becomes defective within 24 months or 24,000 miles after delivery, whichever comes first, any authorized United States or Canadian Volkswagen dealer, to which the customer delivers the car, will repair or replace the defective part free of charge for material and labor with a new or factory reconditioned part, provided the customer presents the dealer with the validated Maintenance Card and provided, further, that the defective part has not become so due to normal use, wear and tear, exposure, misuse, accident or by the installation of non-genuine Volkswagen parts, or by the repair of the car by someone other than an authorized Volkswagen dealer; nor does warranty cover for normal maintenance service such as fuel system cleaning and wheel, brake or clutch adjustment, replacement of service items such as spark plugs, ignition points, V-belts, wiper blades or brake and clutch linings and the deterioration of upholstery, soft trim or appearance items.