

THE GREATEST ADVANCE IN YEARS

# 1941 Ford



# NEW

In some years, and in some cars, automobile value takes a remarkable jump ahead. 1941 is such a year for the Ford. It brings a NEW and larger Ford car—representing all the rich experience gained in building more than 28 million cars. Get the facts. Compare the modern Ford features with the car you are driving now. See why your next car should be a 1941 Ford.

**NEW MASSIVE BEAUTY.** Completely new in design. The biggest, roomiest Ford car ever built. So wide is the new body that running boards have almost disappeared. Bright new colors.

**NEW ROOM THROUGHOUT.** Extremely wide, comfortable seats—seating width increased as much as seven inches. Abundant leg room and head room. Big luggage capacity.

**NEW INTERIOR STYLING.** Rich colors and beautiful modern tailoring. Attractive new instrument panel and steering wheel.

**NEW VISION ALL AROUND.** New large windshield makes driving easier. New wide windows give better vision. Glass area increased by nearly 4 square feet in Sedans. Large curved one-piece rear window.

**NEW FASTER ACCELERATION.** The famous Ford V-8 engine, outstanding in its field, is now geared to give even faster getaway through "first" and "second" with no sacrifice in "top" performance.

**NEW STRONGER FRAME.** Twice as rigid and resistant to twisting force as former Ford frame. Helps keep the body quiet throughout long service.

**NEW LONGER WHEELBASE.** Increased to 114". Extra inches give improved appearance, more room and greater comfort.

**NEW RIDING COMFORT.** Springbase (125") lengthened in proportion to new longer wheelbase. New, slower-acting, soft-riding springs. Improved shock absorbers. Newly designed ride stabilizer.

*GET THE FACTS AND YOU'LL GET A FORD!*

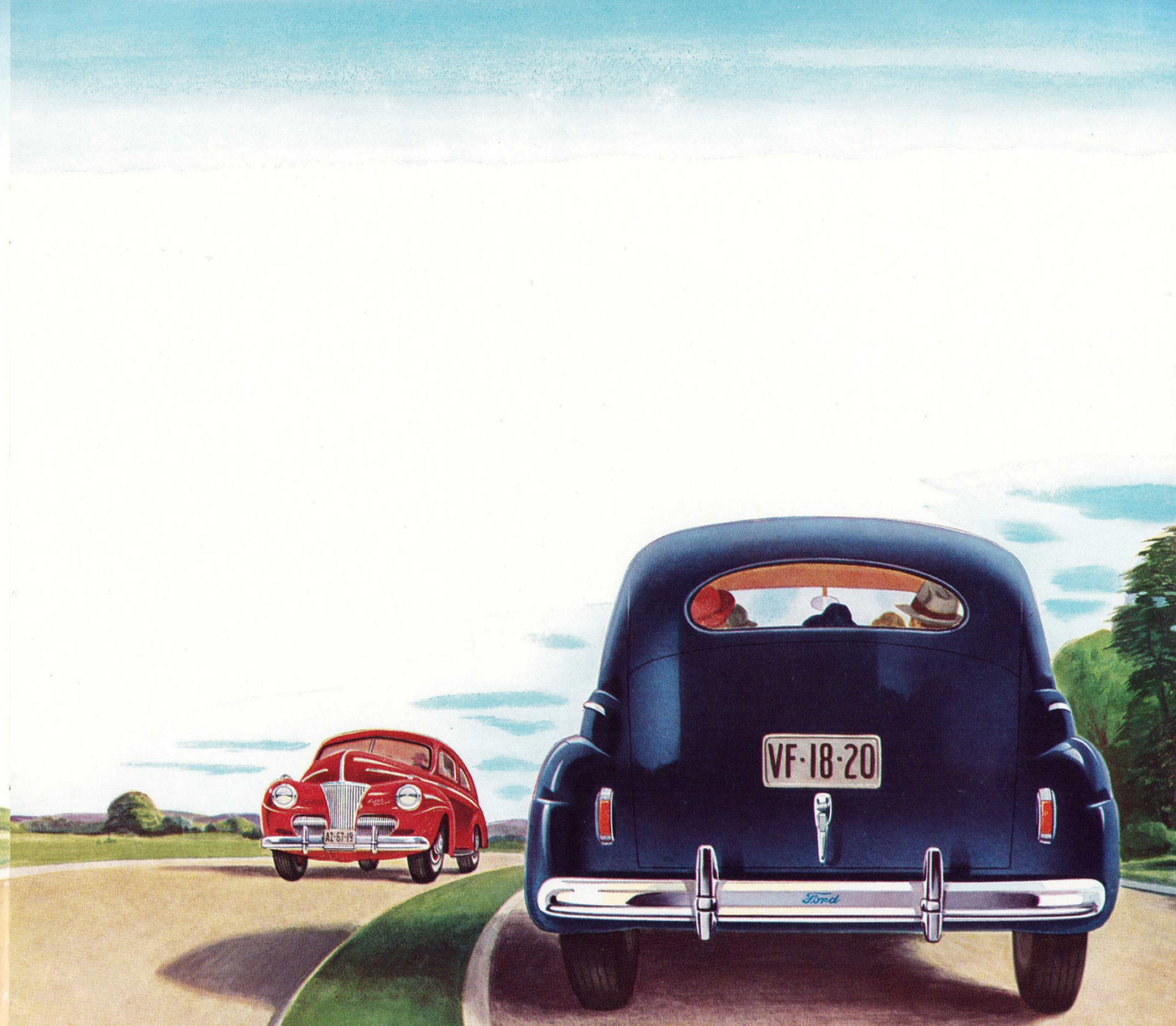

## *Super De Luxe* FORDOR SEDAN

So new, so BIG you'd naturally take it for a high priced car. Skilful design takes full advantage of the new 114" wheelbase. Lines flare out from the massive front end and flow back so smoothly that you don't realize how tremendously *broad* this new Ford is. But you will when you sit beside two other passengers!

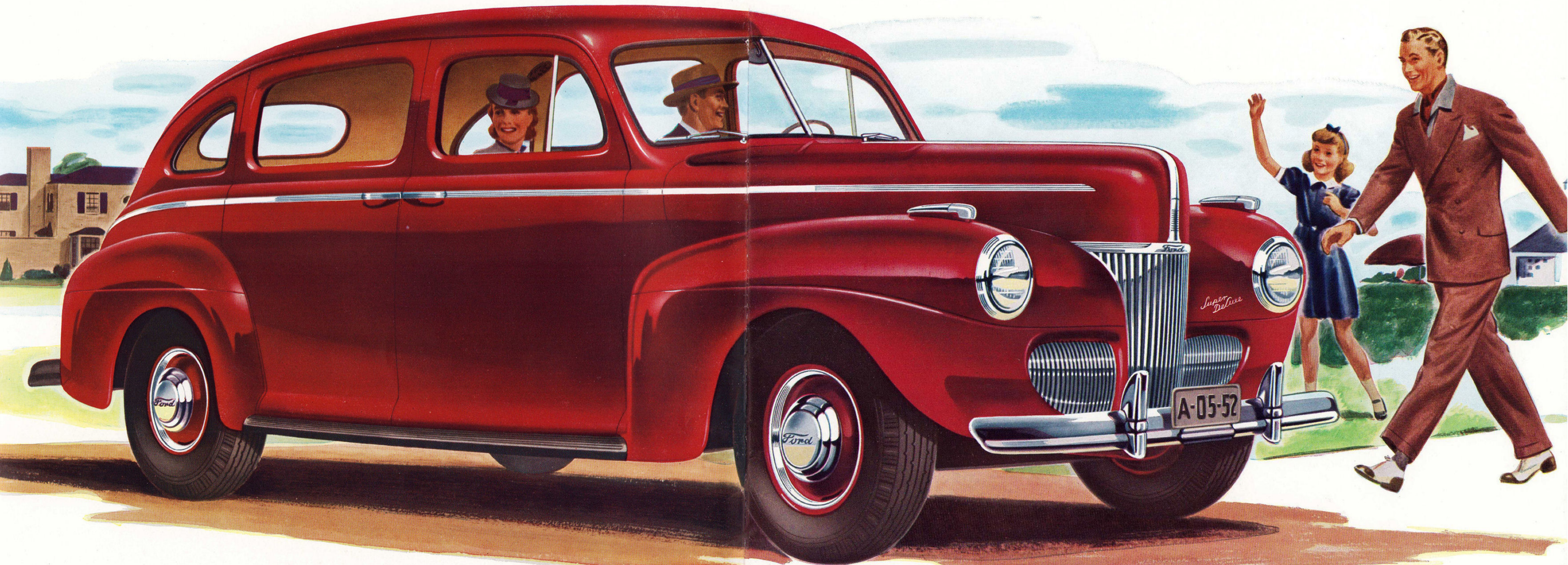

## *Super De Luxe* TUDOR SEDAN

A roomy car with new, wide doors. Like the Fordor, it has a new large windshield and wide windows. Driving is easier, safer, and you see more of the scenery. Extra room, deeply cushioned seats of new design, new springs, large shock absorbers and a newly designed stabilizer contribute to greatly increased comfort.

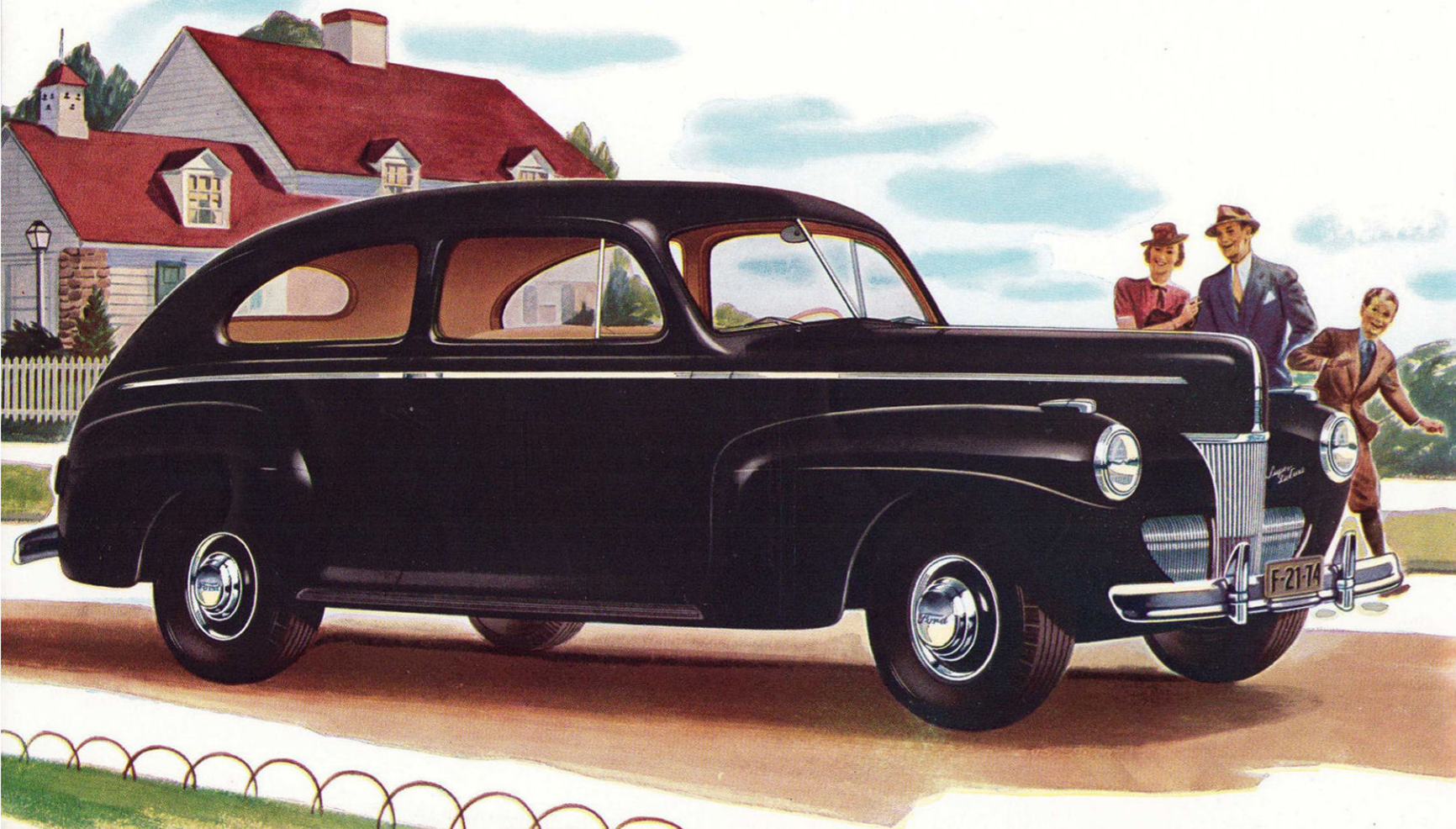

## *Super De Luxe* COUPE (with auxiliary seats)

This beautiful Coupe provides extra seating accommodations. Seat-backs pivot forward for access to a rear compartment, where auxiliary seats fold down for two more passengers. A Coupe without auxiliary seats is also available, with undivided seat-back that can be lifted for access to extra luggage compartment.

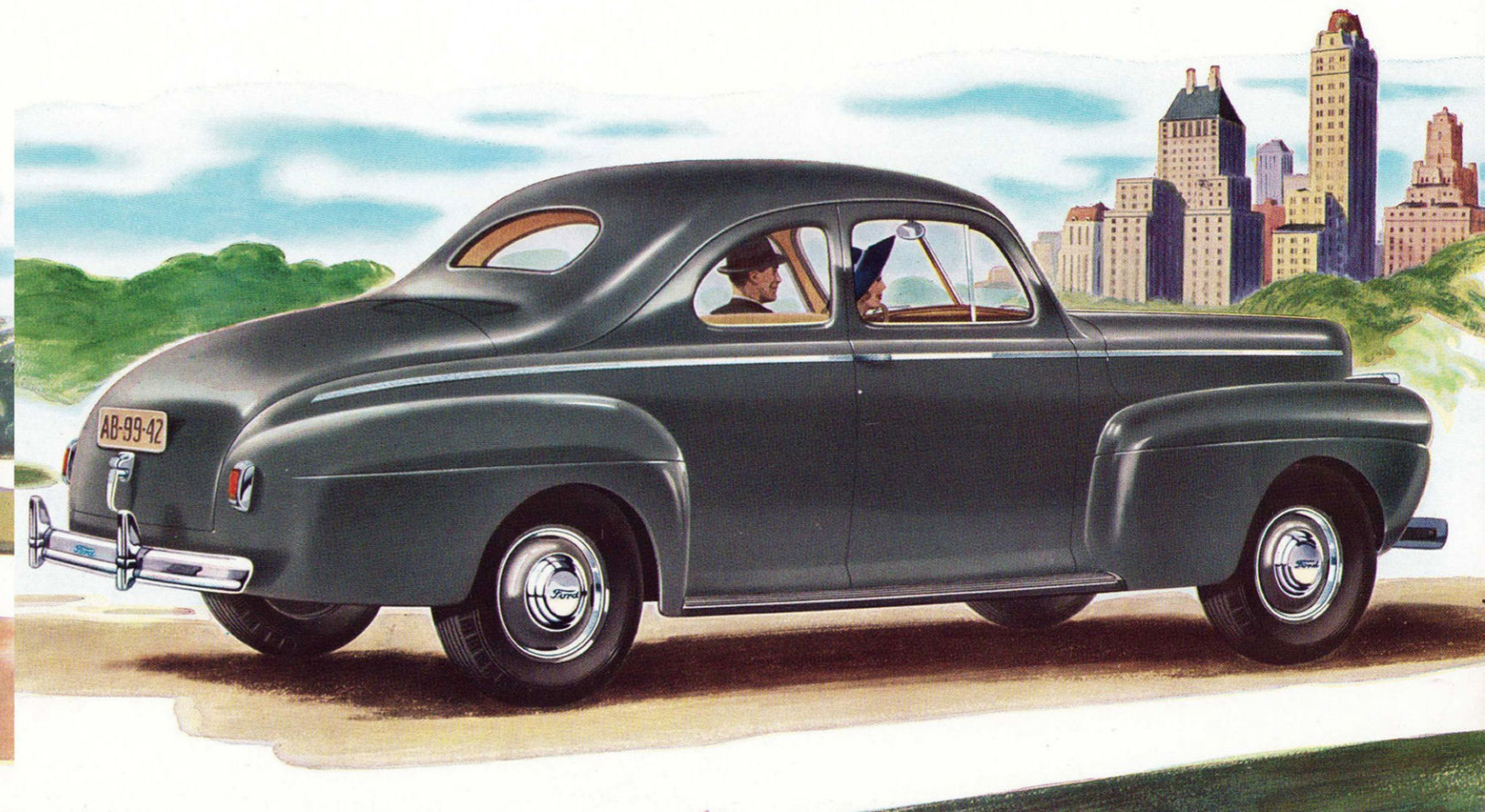

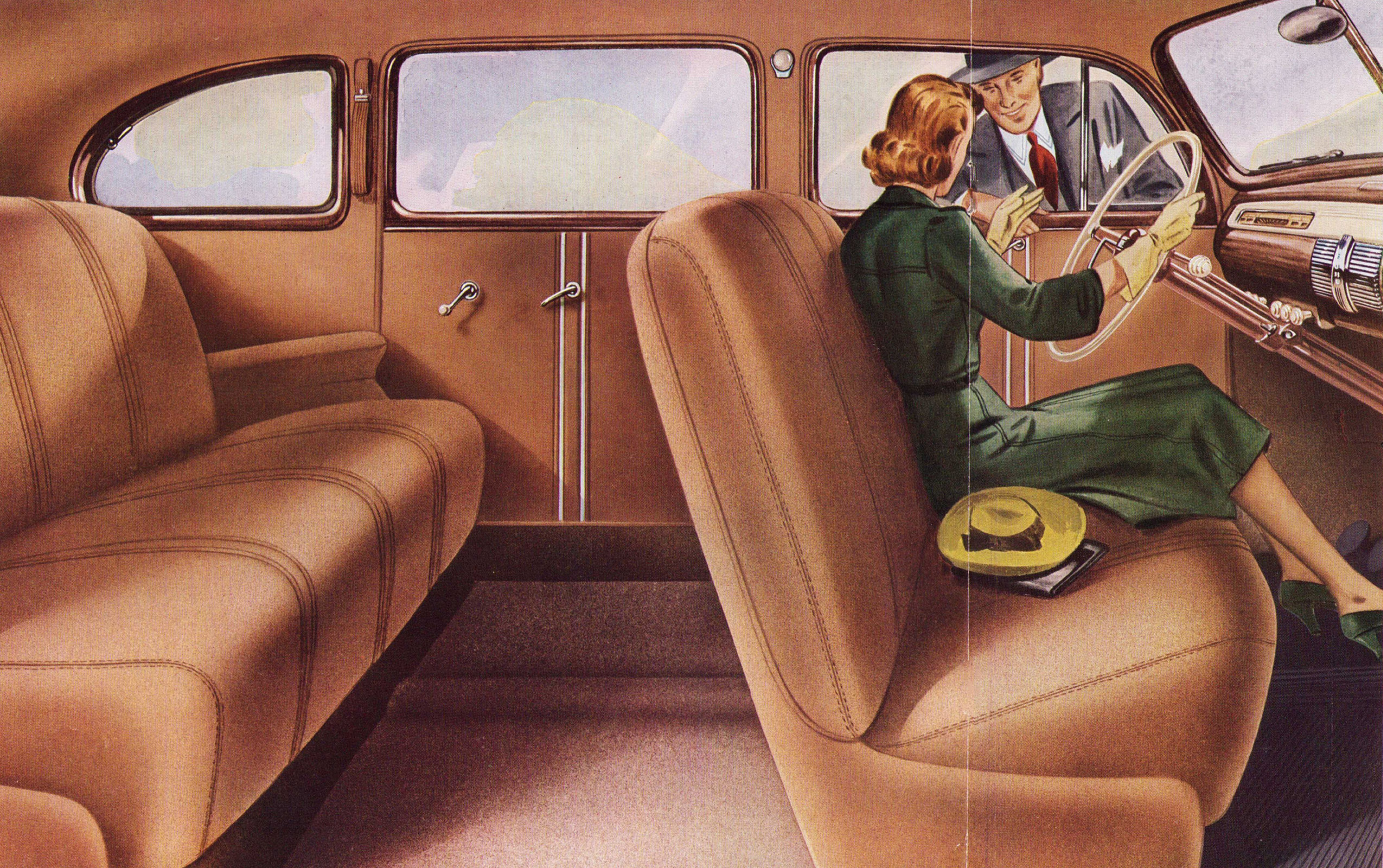

## RICH NEW BEAUTY AND A SMOOTH NEW RIDE

If you respond to beauty, you'll respond to this interior. Here's rich new color harmony—fine, soft upholstery, handsomely tailored—modern appointments that add luxury, convenience, pride of ownership.

And something more! An immediate impression of spaciousness which the tape measure confirms. Front seating width of Fordor Sedan is 56". Rear compartment measures 57" wall to wall, 52" between arm rests. Extra front seat width gives comfort for three without cramping driver.

There's plenty to admire while this big car is standing still. But the real experience comes when it rolls out on the road. Everything connected with the ride is new. Wheelbase, springbase, weight distribution. New springs, improved shock absorbers, a newly designed stabilizer.

They all blend into a gentle, easy-going ride, on rough road or boulevard, that will make you want to talk business with your Ford dealer.

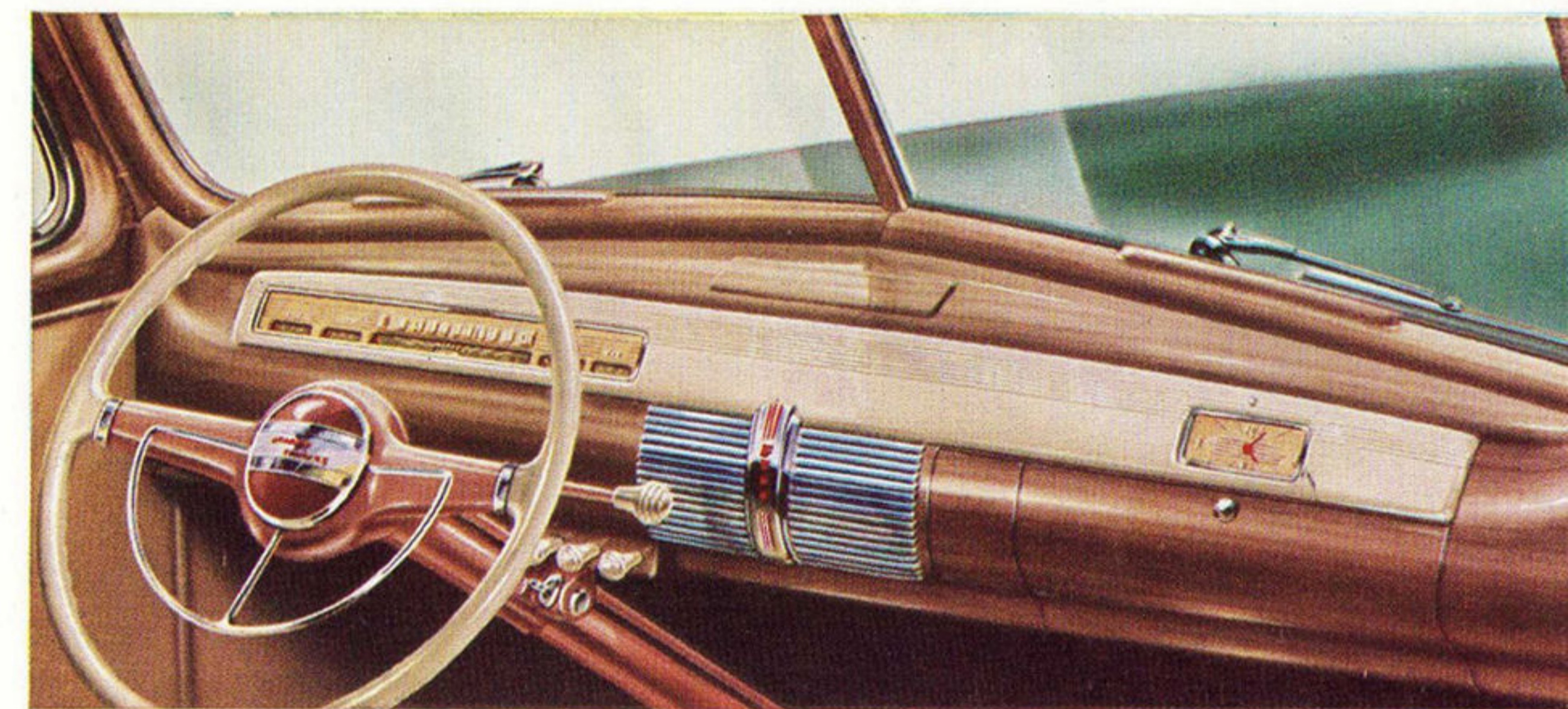

The new Super De Luxe instrument panel is a symphony in beautiful wood-grain finish and gray plastic. Instruments are grouped for perfect visibility through the two-spoke steering wheel. The panel includes a clock, lighter, ash tray, lock for glove compartment, dimming control for instrument lights, ignition key hole light, speed control for windshield wipers, starter button, grille to cover radio speaker, with remote control hood lock under the panel at the left. Notice the handy half-moon horn ring on the Super De Luxe steering wheel.

## *Super De Luxe* CONVERTIBLE CLUB COUPE

The sleekest, sportiest convertible Ford car ever designed. The new automatic top is operated by electric motors instead of by vacuum. Works even when the engine isn't running. Dependable. Constant speed in raising or lowering. The wide, comfortable rear seat makes this an all-weather car for five passengers.

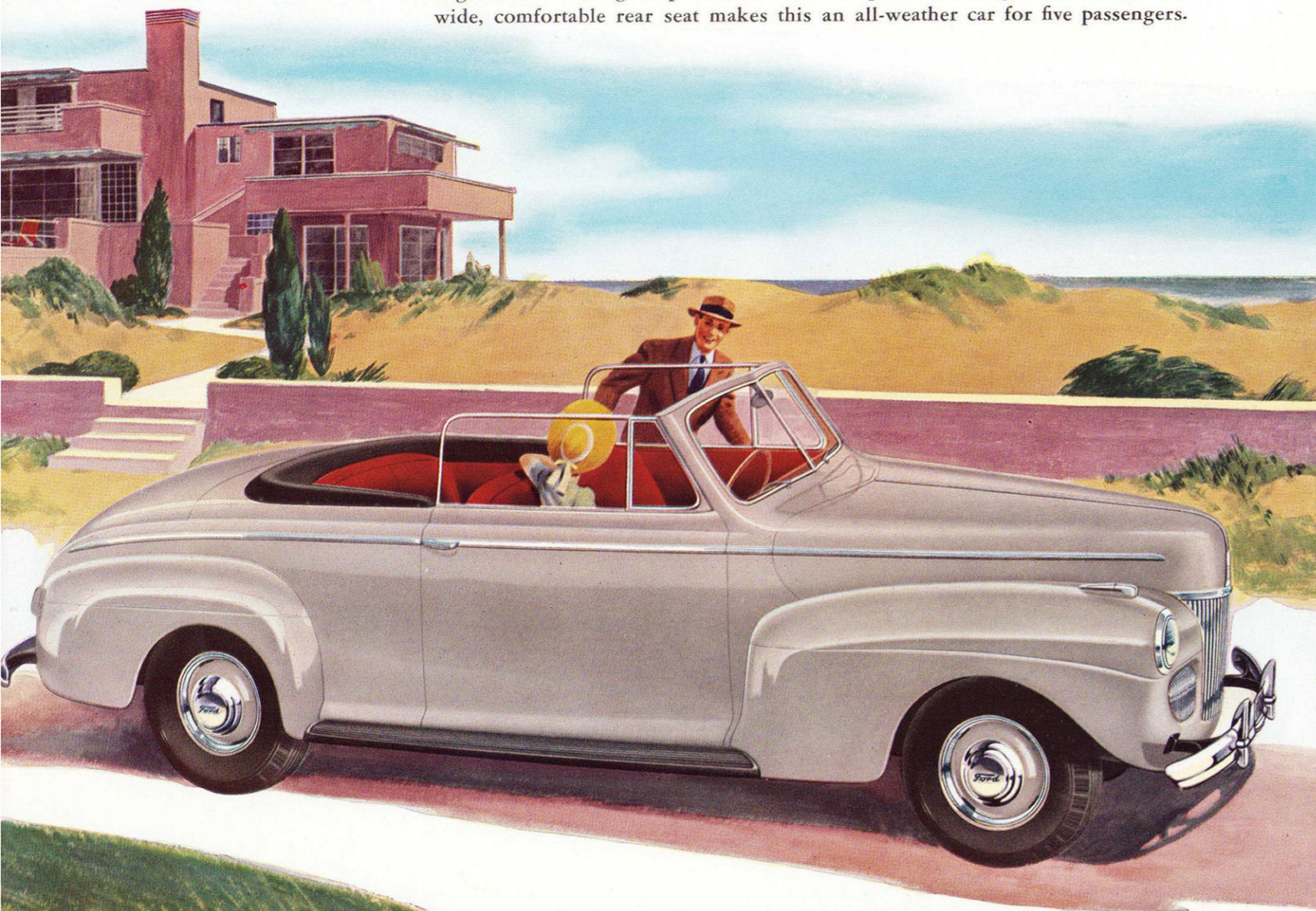

## *Super De Luxe* SEDAN COUPE

A dashing new body type in the Ford line, combining the advantages of compact coupe design with seat room for six. It makes a distinctive personal car with a "custom-built" appearance, and provides real comfort for occasional guests. The rear seat is easily reached by pivoting either front seat-back forward.

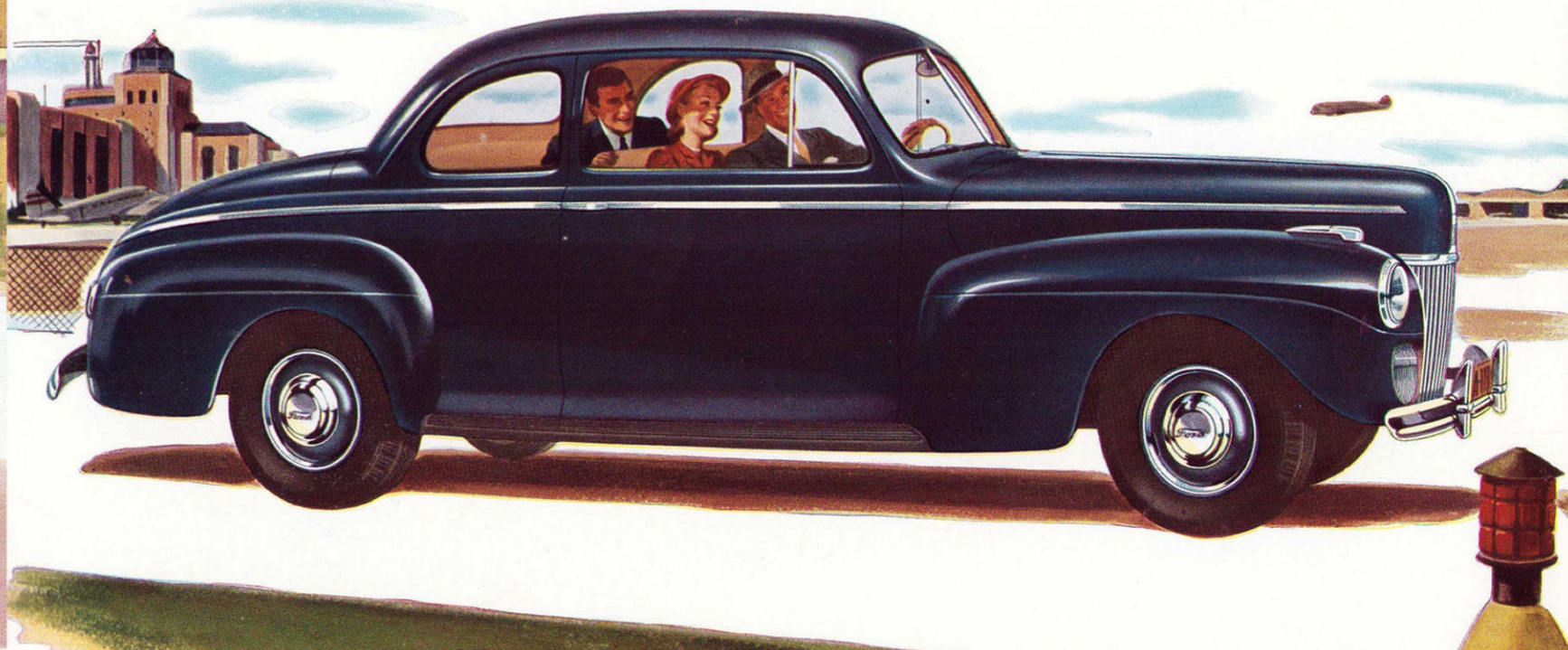

## *Super De Luxe* STATION WAGON

The Super De Luxe Station Wagon for 1941 carries even farther the tradition of smart styling and all-around utility that has put Ford units of this type on many of the finest estates. As a passenger vehicle it seats eight, including the driver. Quickly converted into a utility hauling unit by removing the rear and center seats. Front seat is adjustable. Windows and windshield are Safety Glass. Doors and tail gate can be locked. A De Luxe Station Wagon is available at lower cost.

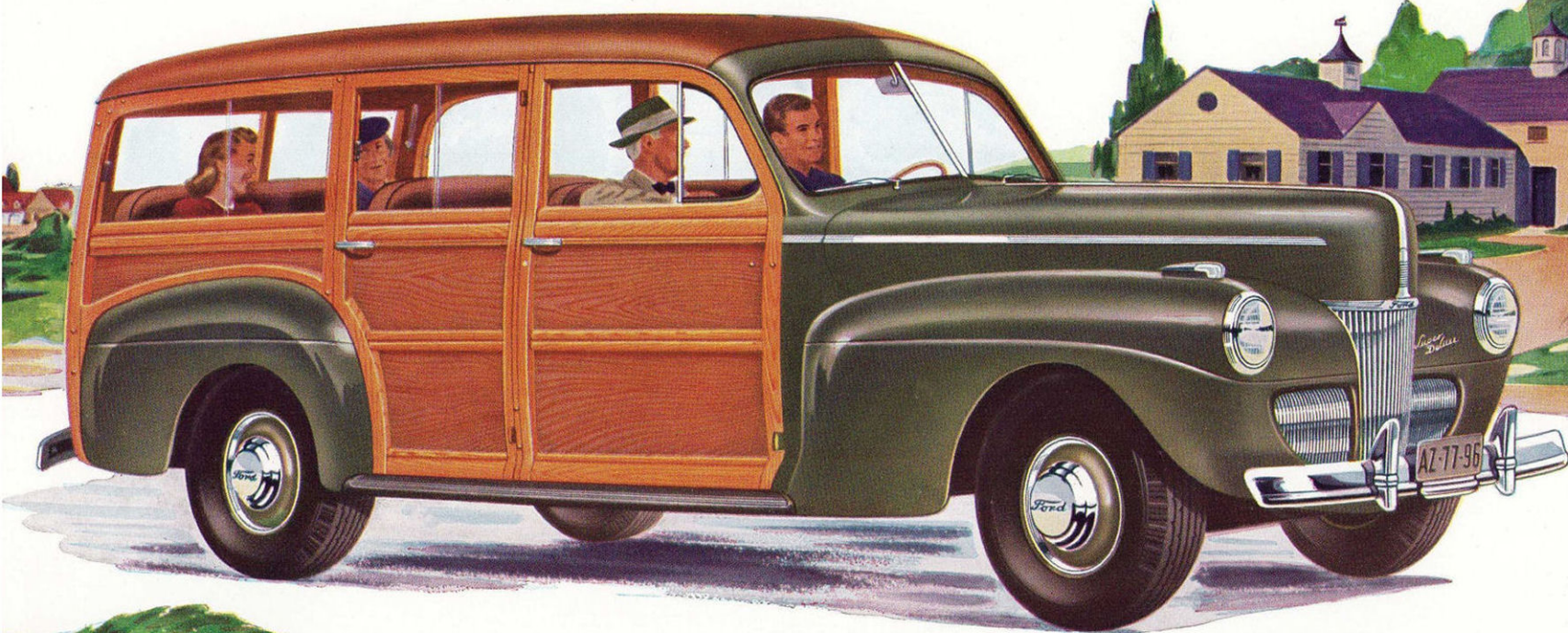

## *De Luxe* COUPE

Notice the smart front-end design which distinguishes the lower-priced De Luxe Ford. It differs from the Super De Luxe in finish and appointments. There are four De Luxe body types—Coupe, Fordor Sedan, Tudor Sedan and Station Wagon. There is also a Special Ford line offered in a still lower price range, with three body types—Fordor Sedan, Tudor Sedan and Coupe. All 1941 Ford cars, the Super De Luxe, De Luxe and Special, are built on the same big, new chassis.



MORE REASONS  
WHY YOUR NEXT  
CAR SHOULD BE  
A FORD

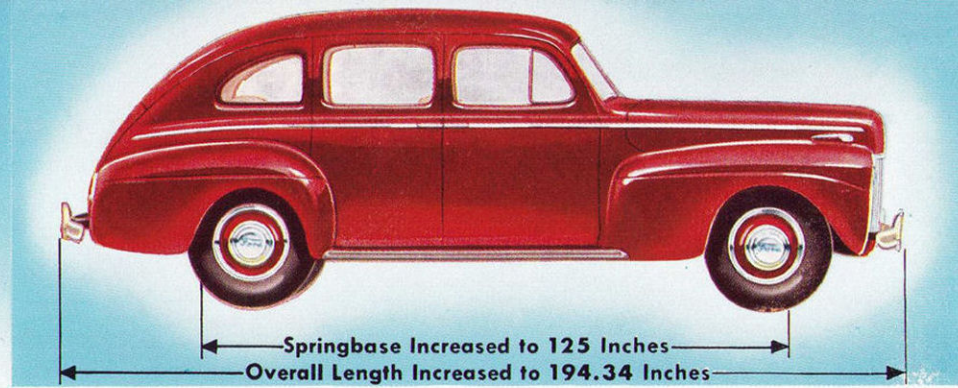

The increased length of the 1941 Ford contributes to its remarkable riding comfort. Springbase has been lengthened in proportion to the new longer wheelbase. Passengers are carried well ahead of the rear axle and spring, near the center of the car where the riding is best. And beneath the flowing beauty of this big car is a rigid new frame, twice as resistant to twisting force as the former rugged Ford frame.

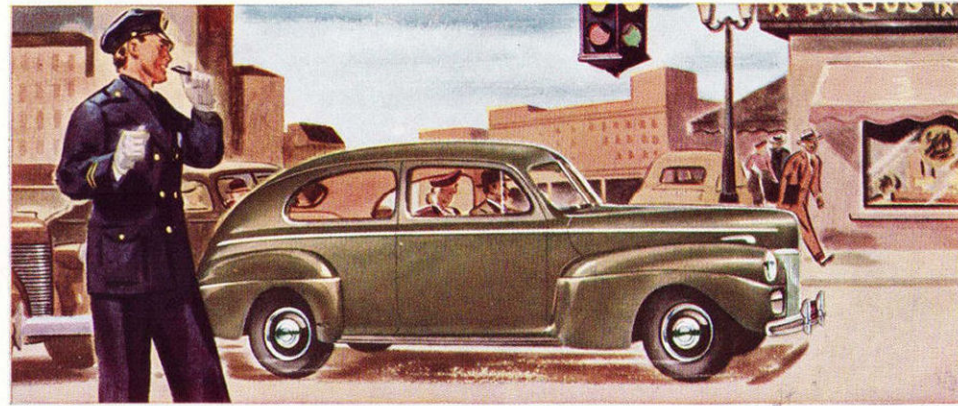

Flash goes the green light. Flash goes the new Ford! Already famous for its smooth, swift power, the Ford V-8 engine is now geared to give even greater acceleration in "first" and "second" without sacrificing "top" performance. It's thrifty power, too! Ford "85" gas mileage has never been higher. And letters from owners of recent Fords say they practically never add oil between 2,000-mile changes.



Built for big people, the 1941 Fordor has a front seating width of 56". Rear compartment is 57" wall to wall, with 52" between arm rests. The body extends over the running boards to gain extra width inside.



The new windshield is wide and deep enough to give a great view of the road, high enough to let you see overhead traffic lights. Windows are big, too, and corner posts narrow. Nearly four square feet of glass area added in Sedans.

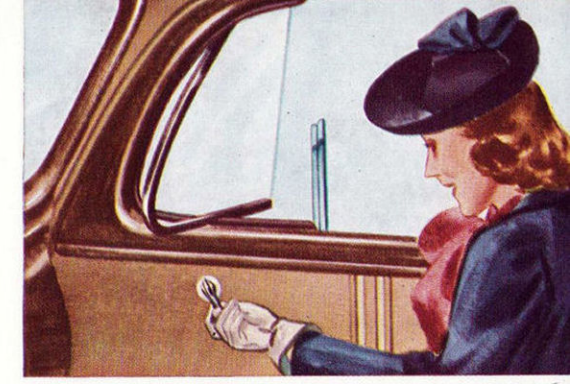

The Ford ventilating system gives you complete control of air circulation. In closed types, metal divider strip slides down with rear half of window. Super De Luxe Ford has crank control for the ventilating wing.

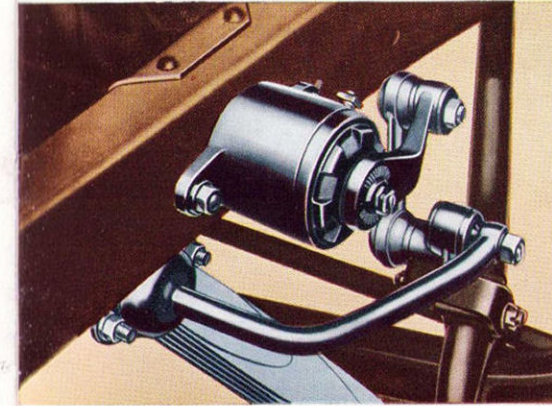

New reverse-angled spring shackles, long, slower-acting springs and improved shock absorbers contribute to the smooth new ride. A newly designed ride stabilizer helps keep the body level and improves steering.

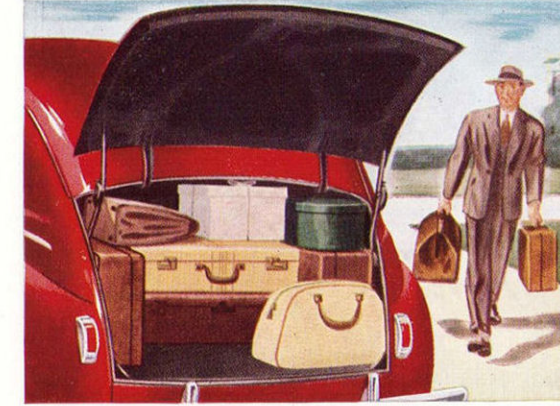

All 1941 Ford body types have exceptionally large luggage capacity beneath their broad rear decks. Space for several big bags and smaller pieces. Spare wheel mounted vertically. Compartment is lined, lighted, and has a floor mat.

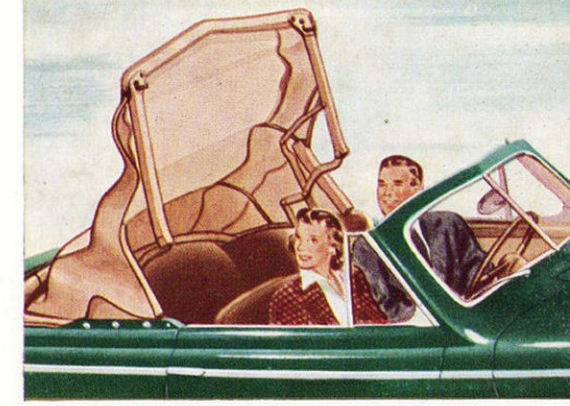

The new automatic top for the Convertible Club Coupe represents a real Ford advance. It works by electric motors instead of by vacuum. Faster, better, more dependable. And it's included in the low Ford price!

(Right) The Ford Motor Company is uniquely equipped to find out facts about automobiles. Scientific research facilities such as those shown here help to account for the outstanding progress made in the Ford cars for 1941.

The huge Ford weather tunnel, for example, only one of its kind in the world, makes any kind of climate to order. Blizzards. Cloudbursts. Sandstorms. Temperatures from 150 above to 20 below zero. High, dry mountain air or heavy jungle humidity.

Constant checking on a hundred counts, helps develop a Ford car that can give good service in all the world's worst weathers.

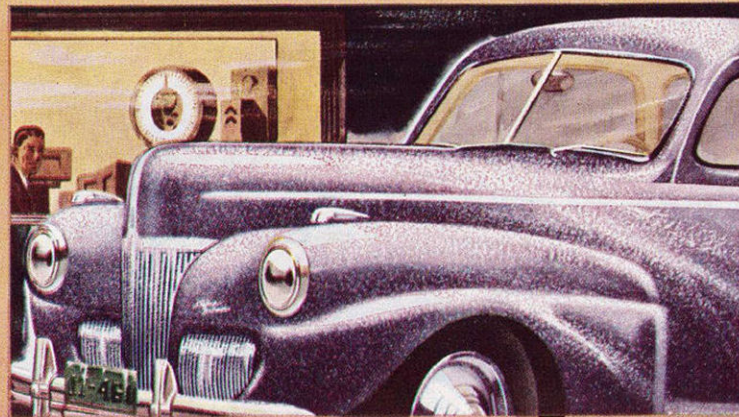

(Right) A new Ford car hurtling over a vicious section of test track known as the "wobble road"—concrete humps scientifically staggered to put terrific strain on tires, wheels, axles, frame and body.

(Far right) Air view of the three big Ford test tracks—made up of many surfaces, including sand pit, water hole, mud bath, cross-wind test, and special skid section. Here test cars are punished unmercifully—then taken apart and studied in the Ford laboratories—to find the facts and give your family a safer, more dependable car.

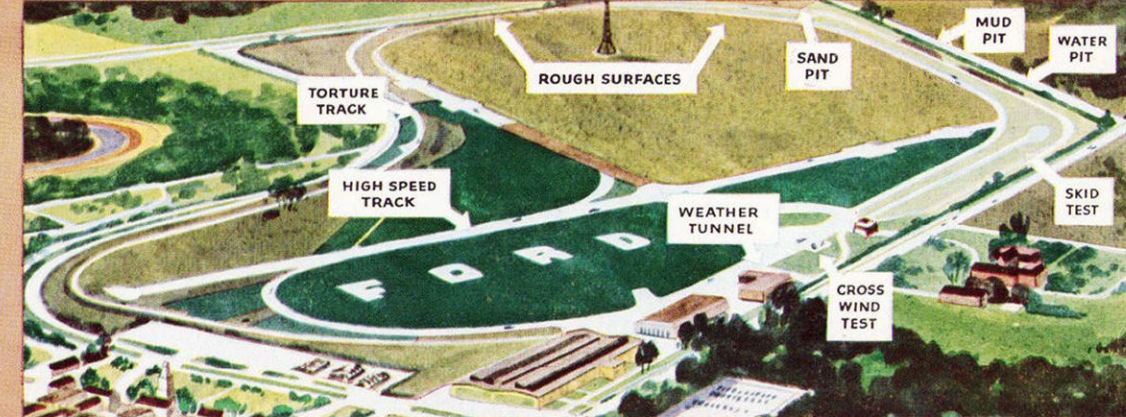
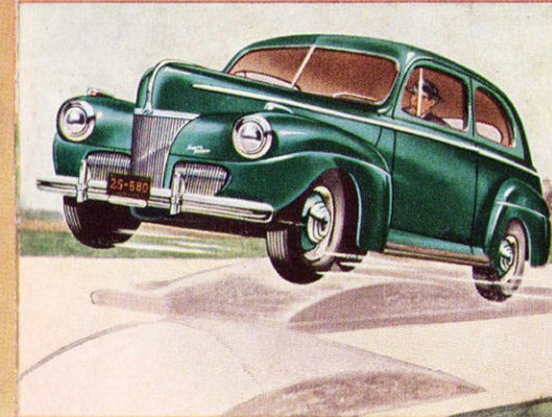



# GET THE FACTS AND YOU'LL GET A FORD!

## FEATURES OF THE SUPER DE LUXE AND DE LUXE CARS

**NEW STYLING:** A big, substantial-looking car from front, side or rear. Modern design provides maximum usable space inside the body. Semi-concealed running boards. Wide-spaced Sealed-Beam Headlamps. Door handles in line with belt molding. Streamlining pre-tested in Ford Weather Tunnel.

**BRIGHT NEW INTERIORS:** Rich new color harmonies make interiors bright and inviting. Beautifully tailored upholstery. Striking new instrument panel in gray plastic and wood-grain finish.

**NEW LENGTH:** Wheelbase increased to 114". Springbase increased to 125". Overall length increased to 194.34". Wide doors in all body types—more than 3½ feet wide in Tudor Sedans.

**NEW WIDTH:** Overall width increased to 73.12". Body extends over running boards to provide exceptionally wide seats. Fordor front seat width 56". Rear seat 57" wall to wall, 52" between arm rests.

**NEW VISIBILITY:** Total glass area increased in all types—by nearly 4 square feet in Sedans. New wide, deep windshield with narrow corner pillars. New large windows. Big, one-piece, curved rear window of tempered glass.

**NEW RIDE:** Smooth "boulevard" ride—result of new wheelbase, weight distribution, and combination of new chassis features. New slower-acting, soft-riding springs. Close balance between front and rear spring action. Newly designed ride stabilizer with swinging shackles. Big hydraulic shock absorbers, double-acting, adjustable, lever-arm type.

**NEW SEATING COMFORT:** New wide seats built with thick, resilient rubberized pad over individually pocketed cushion springs, and with soft "floating edge." Driver's seat raised, giving driver better position. Adjustable within 4½" range. Divided front seat-backs in Tudor types fold forward and inward, away from the doors.

**NEW APPOINTMENTS:** Interesting new appointments for 1941 include remote control hood lock on instrument panel; ignition key hole light; door covering gas tank filler cap; windshield wiper speed control on instrument panel; separate parking lights on fenders; horn ring and crank control for ventilation on Super De Luxe; electrically operated automatic top for Convertible Club Coupe. See "Equipment" for complete list of appointments included in the price.

**NEW ACCELERATION:** New transmission ratios give faster getaway through "first" and "second" with no sacrifice in famous Ford V-8 "top" performance.

**NEW RIGID FRAME:** Resistance to twisting force increased 100%. New welded one-piece X-member with deep box type center section. Helps keep the body quiet throughout long service.

**NEW BODY MOUNTING:** New type rubber insulators between body and frame in all closed body types. Live, resilient, twice as large as type formerly used. Helps block out road noise and chassis sounds. No metallic contact between body and frame. Ford bodies are all steel.

**BIG LUGGAGE CAPACITY:** Spare tire mounted vertically at back of compartment. Compartment is lined, has an automatic light and a rubber floor mat.

**BIG HYDRAULIC BRAKES:** 12-inch brake drums and 162 square inches of lining area for quick stops and long brake life. Easy pedal pressure. Cable-controlled parking brakes on rear wheels.

**V-8 ENGINE:** Only low-price car to offer an 8-cylinder engine. Designed and refined to give gasoline and oil mileage equal to or better than available in any other type engine of equal size and power.

**EASY DRIVING:** Easy-acting Finger-Tip Gearshift on steering column. Blocker-type transmission makes shifting easy and quiet. 18.2 to 1 steering ratio provides effortless steering, easy parking. Semi-centrifugal clutch, with lower pedal pressure for 1941.

**TORQUE-TUBE DRIVE** with front radius rods. An important element in the Ford stabilized chassis. All driving and braking forces are transmitted directly to frame. Springs left free to support the load and cushion road shocks.

**¾-FLOATING REAR AXLE:** Another reason for Ford reliability. Straddle-mounted driving pinion.

**BIG BATTERY:** 120 ampere hours. Big reserve of power for electrical accessories. Improved voltage regulator automatically controls generator output.

**BODY TYPES:** Two De Luxe lines of Ford cars for 1941. *Super De Luxe* body types: Tudor Sedan, Fordor Sedan, Coupe, Sedan-Coupe, Convertible Club Coupe, Station Wagon. *De Luxe* body types: Tudor Sedan, Fordor Sedan, Coupe, Station Wagon. Coupe in both lines available with or without auxiliary folding seats.

**NEW BRIGHT COLORS:** *Super De Luxe:* Choice of Mayfair Maroon, Lochaven Green, Cayuga Blue, Palisade Gray, Harbor Gray, Black. Wheels to match body color. *De Luxe:* Harbor Gray, Cayuga Blue, Black. Wheels black. All colors are enduring baked enamel. Fenders and other sheet metal parts rust-proofed.

**UPHOLSTERY:** *Super De Luxe:* Choice of mohair or combination Bedford and broadcloth weave in closed cars. Brown, red or blue genuine leather seats in Convertible Club Coupe. Brown genuine leather seats in Station Wagon. *De Luxe:* Gray taupe patterned mohair or striped broadcloth in closed types. Brown rubber-processed artificial leather in Station Wagon.

**EQUIPMENT:** (Items marked \* are in Super De Luxe types only). Front and rear bumpers and four bumper guards. Spare wheel, tire and tube. Twin air electric horns. Two combination tail lamps and stop lights. Dual windshield wipers with speed control on instrument panel. Electric lighter. Two sun visors. Foot control for headlight beams with indicator on instrument panel. Dimming control for instrument panel lights. Glove compartment with lock. Ash tray in instrument panel. Arm rests in rear seat of sedan types. Remote control hood lock. Outside key lock on left doors. Ignition key hole light. Separate parking lamps. Grille to cover speaker if radio is installed. Foot rests in Fordor Sedans. Friction type door checks. Automatic light for luggage compartment. Rubber mat on luggage compartment floor. \*30-hour clock. \*Horn ring on steering wheel. \*Crank control for ventilation. \*Ash tray in rear of Sedans. \*Rustless steel wheelbands. \*Trip mileage indicator with setting on instrument panel. \*Assist loops. \*Robe cord in Fordor Sedan. \*Arm rest at driver's side of front seat. Bright chrome interior hardware. Black tires standard. White sidewall tires available at extra cost.

**ACCESSORIES:** A wide range of accessories designed especially for Ford cars is available at moderate cost. New Ford Radio has Roto-Selector Control for fast automatic tuning, and Integral Antenna. Improved Hot Water and Hot Air Heater-Defrosters are available.

**LOW PRICE:** Ford methods, and the established Ford low-profit policy, make it possible to offer greatly advanced value for 1941 at the low Ford prices.

*The Ford Motor Company, whose policy is one of continuous improvement, reserves the right to change specifications, design, or prices without incurring obligation.*

