

SL-Class



Mercedes-Benz





First impressions

Tradition and innovation, exhilaration and safety, efficiency and performance: the new SL is a consummate blend of contrasting qualities. The classic roadster lines hark back to its legendary predecessors, yet have a style that is unmistakably modern. The many intelligent assistants help you to steer clear of danger, and the adaptive suspension systems mean you can tailor the drive to your needs.

The cabin, too, leaves nothing to be desired, offering the kind of comfort that lets you just keep on driving, while the optional panoramic vario-roof with Magic Sky Control gives you views of the heavens even when closed, and switchable transparency to boot. What's more, the SL now benefits from Frontbass, the first in-car speaker system to be integrated with the bodyshell. Pioneering technology that helps it to redefine roadster driving – again.

[Overview](#) | from page 4 [Insight](#) | page 15

Featured models:
SL 500 Cerussite Grey (matt finish) cover and from page 2 AMG Sports Package, AMG 5-spoke alloy wheels, Black Exclusive Nappa leather upholstery and brushed aluminium trim
SL 350 <i>designo</i> Zircon Red metallic from page 8 5-twin-spoke alloy wheels, Porcelain nappa leather upholstery and satin-finish Light Poplar wood trim
SL 63 AMG <i>designo</i> Magno Allanite Grey from page 12 AMG 10-spoke alloy wheels, Black Exclusive Nappa leather upholstery and brushed aluminium trim

Illustrations may include accessories and optional extras which do not form part of the standard specification



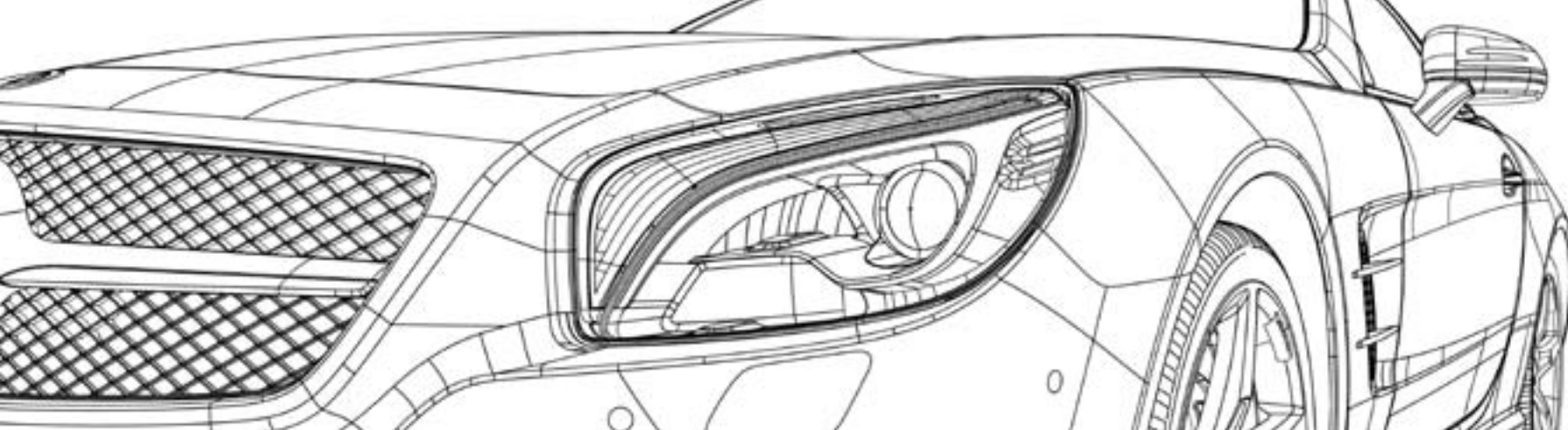

Facts

Maximum enjoyment: BlueEFFICIENCY, petrol engines, transmission and suspension.

Engines and suspension | from page 18

Integrated safety in the SL-Class: safer driving, anticipating danger, protecting occupants and post-crash safety.

Safety | from page 24

Unsurpassed luxury: multimedia systems, electronic assistants, open-top comfort, roof and space, climate control, interior lighting and seats.

Comfort | from page 26

SL and AMG: SL 63 AMG, SL 65 AMG, AMG technology and AMG Performance Studio.

AMG | from page 38

Your personal SL: standard equipment and optional extras, AMG Sports Package, *designo*, upholstery and trim, alloy wheels and Retailer-fit accessories.

Equipment | from page 48

More Mercedes-Benz: test drive, Mercedes-Benz Finance and Insurance, Interactive Owner's Manual, Roadside Assistance and Mercedes-Benz World.

Services | from page 66

SL in figures: dimensions, technical data and paint finishes.

Facts and finishes | from page 68





The stuff of legends: exhilaration

More than 50 years ago, a roadster was born that would go on to be named 'sports car of the century'. It was, of course, the legendary 300 SL, the first in a long line of unforgettable Mercedes-Benz sports cars. Now a new incarnation is here to continue that tradition – and ensure the SL legend lives on.



Your private jet for the road

Piloting the new SL is a sensation that's hard to capture in words. Suffice to say the body is made almost entirely of aluminium, the suspension blends agility and comfort, and the engines are more powerful than ever. An SL is so much more than just the sum of these parts. It's a drive that has to be experienced to be believed. → pages 20-23





Proves you have nothing left to prove

Surpassing oneself again and again is perhaps the greatest challenge of all. Yet the SL has been doing it for over half a century. The latest generation continues that remarkable record. It's not only more powerful than its predecessor but also more efficient, thanks to innovative BlueDIRECT technology and lightweight construction. Meaning the SL now outdoes itself at petrol pumps too. → pages 18–21





Its loss is your gain

Sometimes doing without leads to greater rewards. That's why there are certain things you won't find on the new SL: bass speakers in the doors, for instance. Instead, in a world first, it uses hollow structural members behind the footwell as resonance chambers. The result? A body that sounds every bit as good as it looks. → pages 26-27





A dream that never lets you drift off

The new SL is an ever vigilant companion. Its many electronic assistants ensure you are equally alert, even recognising signs of tiredness, and its extensive network of safety systems make it one of the safest cars on the road. But then what else would you expect? It is, after all, the Mercedes-Benz among roadsters. → pages 24–25, 28–29





Elation on demand

Vario-roof down, accelerator floored – there’s no finer way to release happiness hormones. In fact, euphoria is practically a permanent state in the new SL. Its looks never fail to stir the soul; its performance is a joy that never wanes.



Harnessed but never tamed

The acceleration leaves you breathless, but adaptive suspension and Direct Steering ensure you are the one in control. And should the horsepower suddenly need reining in, there are 4-piston fixed-caliper front brakes that bring you rapidly to a standstill.





Open the SL's vario-roof and sunshine isn't all you'll be basking in. Admiration is guaranteed too, with a cabin that's both sporty and supremely stylish. You can even leave it to soak up the rays without risk of the upholstery overheating, thanks to solar-reflective leather surfaces. An SL is not just for summer though: the optional panoramic glass vario-roof gives you views of the heavens with the roof closed, while the optional Magic Sky Control goes from transparent to tinted at the touch of a button. → pages 30–33





The best just got better

Its predecessor set the standard. Now the new SL 63 AMG has raised the bar yet again. With an unrivalled blend of power and efficiency, and the highest torque of any twin-turbocharged production V8. → pages 38–41



Your biturbo adrenalin boost awaits

Combine SL and AMG and you'd expect the results to be exhilarating. But the SL 63 AMG surpasses even the highest expectations. Superlative performance, breathtaking handling, Mercedes-Benz comfort: it's everything you could want in an SL – and then some.





With a drive like this,
who wants to arrive?



The making of a lightweight legend



The story goes that the L in SL originally signified lightness. Although no proof has even been found in the company archives, it seems more than likely. After all, the task that Rudolf Uhlenhaut, then head of R&D at Mercedes-Benz, set himself when developing the very first 300 SL in the early 1950s, was to create a racing car whose low weight would allow it to leave bulkier rivals trailing in its wake. After much planing, filing and sanding, Uhlenhaut's team presented a tubular steel lattice-frame

chassis, clad with panels of aluminium rather than steel, and an engine that was angled to allow for a lower bonnet. Even the traditional upright grille had to make way, replaced by a lower, more aerodynamic front end. In contrast to the minimalist body, the cockpit was surprisingly luxurious. "The driver," Uhlenhaut explained, "should feel comfortable." A sentiment that equally applies to the new SL, of course – a car that follows in the light footsteps of its illustrious forebear.



18 **BlueEFFICIENCY**19 **Efficiency in the SL-Class**20 **Petrol engines**

V6 petrol

V8 petrol

22 **Transmission**

7G-Tronic Plus

23 **Suspension**

Active Body Control (ABC)

Adaptive Damping System

Direct Steering

Torque Vectoring Brake

24 **Integrated safety concept**

Attention Assist

Intelligent Light System

Magic Vision Control

Driving Assistance Package

Pre-Safe® Brake and BAS Plus

Pre-Safe® system

Restraint systems

Mercedes-Benz Emergency

Call System

26 **Multimedia systems**

Harman Kardon® Logic 7®

surround sound system

Bang & Olufsen BeoSound AMG

COMAND Online system

28 **Electronic assistants**

Speed Limit Assist

Parktronic with Active Park Assist

30 **Open-top comfort**

Aircarf

Electric wind deflector

Solar-reflective leather

32 **Roof and space**

Panoramic vario-roof with

Magic Sky Control

Vario-roof

Panoramic vario-roof with blind

Easy-Pack function

Keyless-Go Comfort Package

34 **Climate control and interior lighting**

Ambient interior lighting

Luxury automatic climate control

36 **Seats**38 **SL 63 AMG**40 **SL 63 AMG technology**42 **SL 65 AMG**44 **SL 65 AMG technology**46 **AMG Performance Studio**

48 Standard equipment**49 Optional extras****50 AMG Sports Package exterior****52 AMG Sports Package interior****54 *designo*****56 Upholstery and trim****62 Alloy wheels**

Standard alloy wheels

Optional alloy wheels

AMG alloy wheels

64 Retailer-fit accessories**66 Services**

Test drive

Mercedes-Benz Finance and Insurance

Interactive Owner's Manual

Roadside Assistance

Mercedes-Benz World

68 Dimensions**69 Technical data****71 Paint finishes**

BlueEFFICIENCY – technology for more efficient driving

Comprehensive BlueEFFICIENCY measures have already brought significant cuts in fuel consumption to all our 4-, 6- and 8-cylinder models (G-Class and R-Class excluded), helping to lower both their CO₂ emissions and their running costs. What's more, we are continuing to develop new environmentally friendly technologies that will reduce emissions even further and help to make motoring more sustainable in the long term.

BlueEFFICIENCY – the Mercedes-Benz efficiency drive.

BlueEFFICIENCY models feature a host of measures that can considerably reduce fuel consumption and CO₂ emissions. They include aerodynamic optimisation, low-resistance tyres and intelligent energy management technologies such as the ECO start/stop function, which comes as standard on the majority of our passenger car models. Many of our model ranges also now offer BlueDIRECT V6 or V8 direct petrol injection engines that deliver significantly more power, while helping to cut fuel consumption by up to 25%.

BlueTEC – cleaner diesel power. BlueTEC is our cleanest diesel technology to date. Its combination of advanced

common-rail direct injection, optimised combustion and modular emissions control systems reduces particulate levels by up to 95% and removes up to 90% of nitrogen oxides, leaving little but water and nitrogen.

Hybrid – internal combustion at its most intelligent.

A combination of components working together in perfect harmony, the Mercedes-Benz hybrid drivetrain allies a conventional engine to an electric motor that boosts power when required – during acceleration, for instance – and enables brake energy to be recuperated then fed to the battery. What's more, our latest-generation hybrid models allow you to travel for over half a mile in almost noiseless electric-only mode (at speeds of up to approx. 20 mph) and can 'coast' at higher speeds, by shutting down the combustion engine for maximum efficiency and zero emissions.

Innovative new drivetrain concepts. Mid-2013 will see our second all-electric production car: the new SLS AMG Coupé Electric Drive.¹ With its four synchronous motors, it will bring new levels of performance to electric motoring, delivering 739 hp (551 kW) and 1,000 Nm.

In fact, despite producing zero local emissions, it will be the most powerful AMG road car of all time. One electric Mercedes-Benz that's already hit the road is our hydrogen fuel cell-powered B-Class, a small fleet of which is already being put through its paces in real-world conditions. As a technology leader, Mercedes-Benz will continue to refine and enhance these electric drivetrains and, in conjunction with our cooperation partners, to expand the network of hydrogen filling stations. Our F 125! F-CELL Plug-In HYBRID, meanwhile, demonstrates the possibilities of innovative zero-emission motoring for luxury vehicles.

Design for Environment. Our environmental philosophy is not just about in-car technologies. It also involves taking the entire lifecycle of each vehicle into account, from its initial planning to its end-of-life recycling. In addition, Mercedes-Benz is involved in the development of alternative fuels and conducts research in the field of bionics.

For more information about what BlueEFFICIENCY can do for you, please visit www.mercedes-benz.co.uk/blueefficiency

¹ SLS AMG Coupé Electric Drive: combined CO₂ emissions: 0 g/km; combined power consumption: 26.8 kWh/100 km; efficiency rating A+
Figures obtained in accordance with the prescribed measuring process (Regulation [EC] 715/2007 in the currently applicable version).

The figures are not based on an individual vehicle and do not constitute part of the product offer; they are provided solely for purposes of comparison between different vehicle models

Efficiency in the SL-Class

The SL has always set the standard when it comes to roadster comfort and performance. Now it leads the way in efficiency and emission levels too.



Environmental protection and energy conservation are of ever increasing importance. That's why we've not only made the new SL even sportier and more torquey, we've also significantly reduced its fuel consumption – via efficient BlueDIRECT engines that deliver more power and yet use up to 29% less fuel plus a wide range of other BlueEFFICIENCY features.

- 1 Lightweight construction with aluminium body and other weight-saving measures
- 2 Up to approx. 29% lower fuel consumption thanks to BlueDIRECT engines (SL 350 and SL 500)
- 3 Aerodynamic optimisation (exterior mirrors, underbody guard)
- 4 Tyres designed for lower rolling resistance
- 5 Air-conditioning compressor only active on demand
- 6 Adjustable radiator shutter
- 7 ECO start/stop function
- 8 Current fuel consumption display
- 9 On-demand alternator
- 10 7G-Tronic Plus 7-speed automatic transmission
- 11 Energy-saving ancillary systems (on-demand fuel, oil and power steering pumps)
- 12 All engines meet EU5 emissions standards



Petrol engines

The new SL is a sports car through and through, not least thanks to torquey and powerful engines that deliver performance on demand.

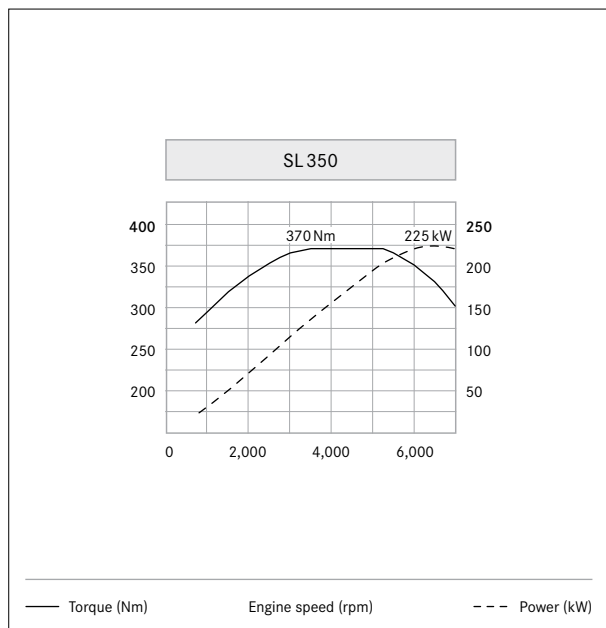

With an output of 306 hp (225 kW), the SL 350 delivers impressively dynamic performance

V6 petrol engine. The new SL 350's innovative BlueDIRECT V6 engine features extensive use of light-weight materials and a range of advanced engine technologies. These include spray-guided direct petrol injection via piezo injectors, four valves per cylinder, and variable camshaft control for the intake and exhaust valves. The result is improved performance, combined with up to 29% reduction in fuel consumption and up to 22% reduction in CO₂ emissions. In addition, fuel consumption is further improved by the all-new air intake and exhaust system, on-demand ancillaries and intelligent alternator management. With an output of 306 hp (225 kW), the SL 350 offers powerful acceleration even at low engine speeds and excellent refinement across the rev range, while a special resonance intake manifold makes for a muscular engine sound.

V8 petrol engine. The new SL 500's BlueDIRECT V8 offers a maximum output of 435 hp (320 kW) and some 700 Nm from 1,800 to 3,500 rpm. On the road, that means effortless performance whatever the speed or situation. Thanks to its lightweight construction, lower 4.7-litre displacement, direct petrol injection via ultra-precise piezo injectors and innovative BlueEFFICIENCY technologies, the new engine succeeds in combining a significant increase in output and torque with a reduction in fuel consumption of up to 22%. The intercooled twin turbochargers, meanwhile, ensure instant pulling power is available at all times.





The SL engines combine efficiency and enjoyment



Transmission

Innovative transmission technology ensures the power of the SL's free-revving engines is transferred effortlessly to the road.

7G-Tronic Plus (standard). The new SL features our high-tech 7G-Tronic Plus 7-speed automatic transmission and comes with steering wheel shift paddles as standard. The seven forward gears allow for a wider spread between the lowest and highest gear, as well as more closely spaced ratios that make for almost imperceptible shifts. As a result, 7G-Tronic Plus improves acceleration, helps to optimise fuel efficiency and enables the ideal engine speed to be maintained at all times. It can also skip gears in downshifts for more rapid overtaking.

In the SL, the transmission benefits from a new-generation torque converter that makes for even faster responses, further reducing noise. Furthermore, fuel efficiency is significantly improved by ECO start/stop, which cuts the engine automatically at lights and in traffic jams.



7G-Tronic Plus: the result of more than 50 years' experience in automatic transmission technology



Suspension

Thanks to intelligent electronics and individually selectable settings, the new SL offers both exceptional cruising comfort and dynamic handling.

Active Body Control ABC (optional). Active Body Control (ABC) combines maximum ride comfort with enhanced dynamics, thanks to a combination of active suspension and passive damping. It helps to minimise pitching and diving under acceleration or sharp braking and also significantly reduces body roll when cornering. The driver can switch between 'Comfort' and 'Sport' settings at the touch of a button, with the chosen setting shown on the COMAND display.

Adaptive Damping System (standard). Via constant and seamless adjustments to each wheel's damping, this electronically controlled damping system adapts automatically to the situation and surface, giving you greater stability at all speeds. The system also features a 'Sport' mode that can be activated manually.

Direct Steering (standard). This variable-ratio steering system makes for more effortless manoeuvring with smaller inputs, as well as more agile cornering.

In addition, the electro-mechanical power assistance helps to reduce fuel consumption.

Torque Vectoring Brake (standard). By distributing torque between the wheels as required, the Torque Vectoring Brake helps to enhance roadholding and safety during sportier driving.



The standard suspension's Adaptive Damping System offers an ideal blend of agility and comfort



Integrated safety concept

Like all our passenger cars, the SL is built according to an integrated safety concept. It combines comprehensive occupant protection with intelligent systems that can help to prevent accidents from occurring.

As the inventor of the motor car, we feel a particular responsibility towards road safety. That's why we were the first manufacturer to develop an integrated safety concept that seamlessly combines a car's active and passive safety features, thus ensuring optimum all-round protection. This concept incorporates measures designed to maximise safety in every situation, by helping you to stay safe, alerting you to danger, and assisting you wherever possible. In addition, our unique Pre-Safe® anticipatory safety system recognises likely accident scenarios and takes steps that help to further enhance occupant protection. If a collision can't be avoided, intelligent passive safety systems help to provide protection where it's needed, while solutions that can minimise the consequences of an accident and facilitate emergency assistance are, of course, also included.

Our integrated safety concept spans four distinct phases: safer driving, anticipating danger, protecting occupants and post-crash safety. The following pages present some of the key features for each phase.

Safer driving: Attention Assist (standard). Particularly beneficial on long journeys, Attention Assist is an innovative system for detecting fatigue. Between speeds of approximately 50 and 110 mph, it assesses the driver's behaviour via an array of sensors and registers unexpected changes that may indicate tiredness or concentration lapses, such as involuntary movements of the steering wheel.

Safer driving: Intelligent Light System (standard). The Intelligent Light System offers a variety of modes



Magic Vision Control: the SL's adaptive windscreen wash system cleans the windscreen without impeding visibility

and functions that optimise visibility for different types of driving, helping you to see the line of the road more clearly and spot potential hazards earlier. In country mode, the side of the road is illuminated more effectively, while motorway mode widens the beams to cover the entire carriageway. Fog mode improves visibility in bad weather, while cornering light and the Active Light System respond to steering inputs for better visibility in turns and bends. Also included is Adaptive High Beam Assist, a system that automatically adjusts the headlamps' range as required, dipping them whenever it spots the lights of an oncoming vehicle, then switching to full beam as soon as the road is clear.

Safer driving: Magic Vision Control (standard). This adaptive windscreen wash system squirts the screenwash onto the windscreen via channels in the wiper blade. This improves visibility during washing, reduces the amount of fluid used and lessens the likelihood of spray entering the cabin when driving with the roof open. The Magic Vision Control system is also heated, along with the screenwash reservoir and pipes, helping to prevent them from icing over in cold weather.



Safer driving: Driving Assistance Package (optional; standard on SL 65 AMG). For even greater levels of active safety, this option package adds DISTRONIC Plus radar-assisted cruise control, Active Blind Spot Assist, Active Lane-Keeping Assist, Brake Assist (BAS) and Pre-Safe® Brake.

Anticipating danger: Pre-Safe® Brake and BAS Plus (part of optional Driving Assistance Package). If it detects the risk of a collision, Pre-Safe® Brake alerts the driver via visual and audible warnings. At the same time, BAS Plus assesses the brake force required in order to avoid an impact. If the driver applies the brakes but uses insufficient force, BAS Plus automatically raises the braking pressure to a level that exploits the remaining stopping distance to the full. Should the driver fail to react to Pre-Safe® Brake's warning signals, the system applies the brakes automatically. If the driver still fails to respond, it then initiates autonomous emergency braking, enabling the speed and severity of any impact to be significantly reduced.

Anticipating danger: Pre-Safe® anticipatory safety system (standard). If it detects a probable accident scenario, Pre-Safe® can take anticipatory measures in order to protect the occupants, such as activating the seat belt tensioners, automatically closing the windows and moving the passenger seat to a safer position for an impact.

Protecting occupants: restraint systems (standard). The SL's 3-point seat belts, seat belt tensioners, belt force limiters and airbags work together to keep injuries to a minimum, activating as the type and severity of the accident requires. The dual-stage front airbags protect the head and upper body and also help to hold the body in place, while the standard headbags and sidebags can reduce the risk of injury from side-on collisions. If the crash sensors detect an impact, the seat belts are instantly tensed, helping to ensure the occupants remain firmly in their seats, with the belt force limiter relaxing the belt as the situation allows in order to prevent undue force being applied to the rib cage.

Post-crash safety: Mercedes-Benz Emergency Call System (part of COMAND Online). Should the restraint systems' sensors detect an accident, the emergency call system can use a mobile phone to automatically contact the emergency services (if the phone is switched on and connected to the vehicle). In addition, it simultaneously sends GPS data and other vehicle information to the Mercedes-Benz emergency call centre, where an operator will attempt to make contact with you by phone.



Multimedia systems

The SL offers a range of first-class audio and navigation systems. Frontbass ensures exceptional acoustics, while the COMAND Online system combines audio and video entertainment with hard drive navigation.

Harman Kardon® Logic 7® surround sound system (optional). The 600-watt Logic 7® surround sound system with Frontbass and Dolby Digital 5.1 makes every journey a listening experience to remember. Its 14 high-performance speakers and MOST amplifier with digital sound processing deliver three-dimensional sound, while speed-sensitive volume control ensures optimum enjoyment at all times.



The Harman Kardon® Logic 7® surround sound system guarantees an outstanding listening experience

Bang & Olufsen BeoSound AMG (optional; standard on SL 65 AMG). With Frontbass, 12 high-performance speakers and a 900-watt output, this high-end surround sound system turns your SL into an open-topped concert hall. The acoustic lenses help to create the trademark Bang & Olufsen sound stage, while the menu allows the sound to be optimised according to which seats are occupied.



Aesthetic audio: acoustic lenses make for enhanced sound and an exclusive look

COMAND Online system (standard). The COMAND Online system combines hard disk drive navigation featuring 2D or 3D maps with entertainment features such as a 6-disc CD/DVD changer with MP3 playback, a music library with 10 GB of storage space and speed-sensitive volume control. The USB port and aux-in socket, SD memory card slot and Bluetooth® interface allow external devices and telephones to be connected. (In conjunction with an Internet-enabled mobile phone, the system also offers access to Web content and to a range of Mercedes-Benz mobile services.) COMAND Online can be operated using the central controller and the buttons of the multi-function steering wheel or via Linguatronic voice control, with all menus and maps shown on a high-resolution 7-inch colour display. In addition, free map updates are available for the COMAND Online navigation system from your Mercedes-Benz Retailer for the first three years after your car's registration date.



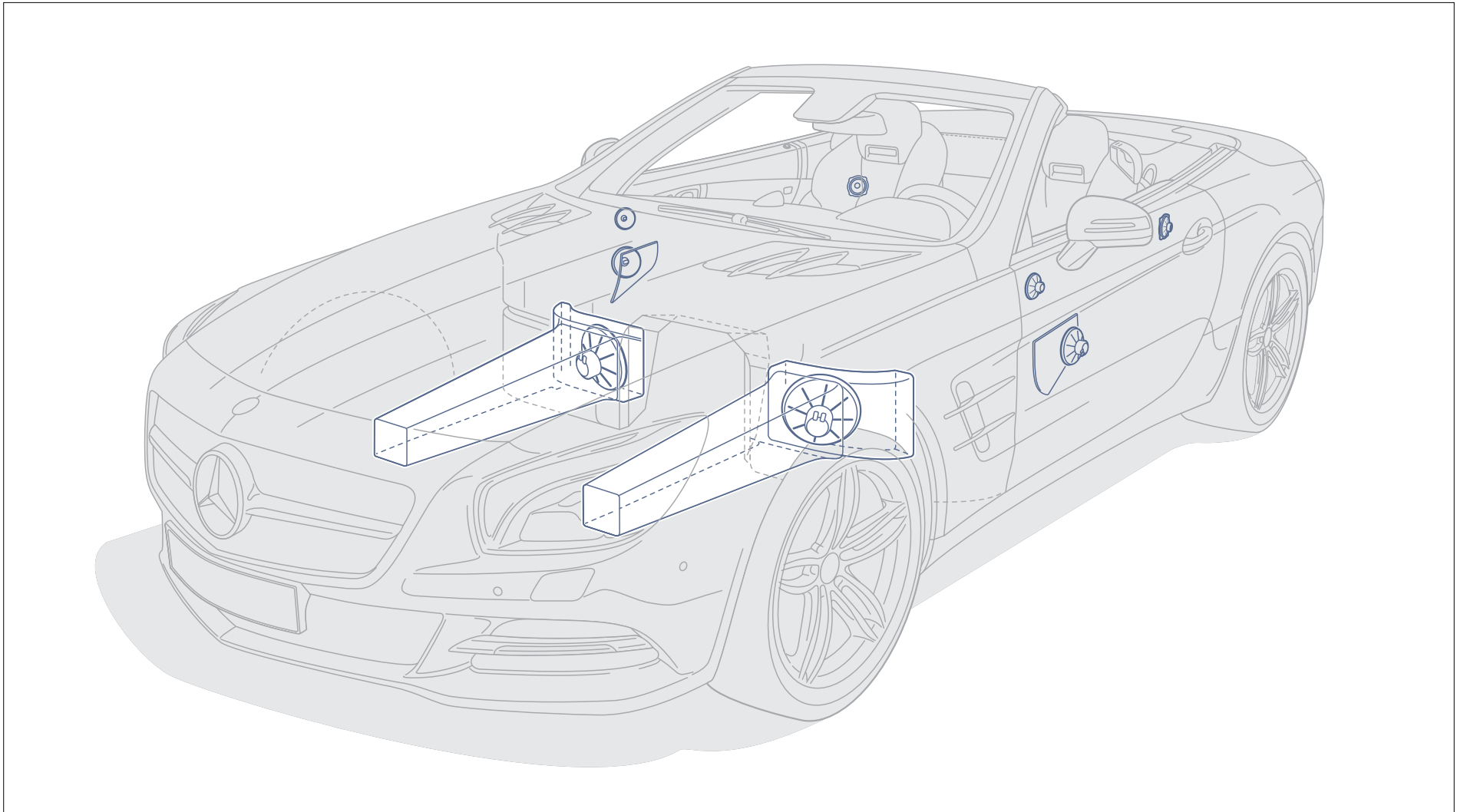

The SL's Frontbass technology is a world first for in-car audio. The integration of the low-range speakers with the bodyshell helps to deliver a more balanced sound and more powerful bass, especially when listening with the roof open



Electronic assistants

The new SL offers a range of helpful assistants that make for more effortless driving and manoeuvring, helping to ensure your journey is as relaxing as possible.



Speed Limit Assist (part of the standard COMAND Online system). Thanks to a windscreen-mounted camera that permanently scans the car's surroundings, Speed Limit Assist can recognise speed limits and display them in the instrument panel. Particularly useful in areas where the limit varies or when passing through roadworks, it helps to make sure the driver is aware of the legal limit for the current road or situation.



Speed Limit Assist shows you the current legal limit on the instrument panel and in COMAND Online's central display

Parktronic with Active Park Assist (optional; standard on SL 65 AMG). At low speeds, Active Park Assist looks for parking spaces automatically and, if it finds a suitable space, alerts the driver via a 'P' and an arrow in the instrument panel. If the driver then accepts the proposed space and engages reverse, the system steers you in automatically, leaving you to simply operate the accelerator, transmission and brakes as required. The manoeuvre takes a maximum of five moves and can be interrupted or corrected manually at any time. If Active



Active Park Assist identifies suitable parking spaces and can even steer you in automatically

Park Assist is not used, the Parktronic parking aid watches over the front and rear when manoeuvring at speeds of up to 10 mph and warns you should you get too close to another vehicle or object.



Open-top comfort

The new SL is roadster driving at its most refined – in any season and almost any kind of weather.

Airscarf (optional; standard on SL 65 AMG). Developed in-house at Mercedes-Benz, Airscarf is a heating system that lets you extend the open-top season. Thanks to subtly integrated vents in the head restraints, it can send a stream of warming air towards the head and neck of each occupant, enabling you to keep the roof down even in cooler weather.



The Airscarf neck-level heating system lets you enjoy open-top driving even in cooler weather

Electric wind deflector (optional). The electric wind deflector keeps the cabin almost entirely free of draughts when driving with the roof open. It comprises a textile mesh within a trapezoidal frame that can be raised electrically at the touch of a button located in the centre console.



The electric wind deflector keeps draughts to a minimum in open-top driving

Solar-reflective leather (standard in conjunction with leather, nappa leather or Exclusive Nappa leather upholstery; not available with *designo* leather). The SL is available with solar-reflective leather upholstery. In bright sunshine, its special coating helps the seat surfaces to stay cooler, ensuring optimum comfort even on the hottest of days.





The new SL offers intelligent features that ensure neither draughts, sunshine nor cool weather can detract from your driving enjoyment

Multi-spoke wheels shown are not available in UK



Roof and space

The new SL redefines notions of roadster comfort. Its vario-roof provides all-weather protection and generous luggage space, while the new panoramic vario-roof with Magic Sky Control offers switchable transparency with the roof closed.



Panoramic vario-roof with Magic Sky Control (optional). Available for the optional panoramic vario-roof, Magic Sky Control can switch from transparent to tinted at the touch of a button, allowing you to choose between maximum light or effective protection from glare. With the roof closed, Magic Sky Control's tinted mode also makes for a significantly cooler cabin on hot days. Magic Sky Control is a Mercedes-Benz innovation.



Vario-roof (standard). The electro-hydraulic vario-roof makes the SL a genuine all-season roadster, transforming it from a two-seater coupé into an open-top roadster in less than 20 seconds. The vario-roof folds neatly away into the boot, leaving up to 364 litres of luggage capacity, and can be raised again just as quickly. It can also be opened and closed remotely via an infra-red enabled car key.



The SL's boot offers ample luggage space even with the roof open

Panoramic vario-roof with blind (optional; standard on SL 65 AMG). With the panoramic vario-roof, you can enjoy a feeling of openness even with the roof closed. Its large tinted glass surface affords clear views of the sky above, while a manually-operated blind offers shade in bright sunshine.



The panoramic vario-roof offers clear views of the sky even when closed

Easy-Pack function (standard). By allowing the folded roof to be lifted electrically, the convenient Easy-Pack function gives you easier access to your luggage when the roof is stowed. Pressing the button on the boot lid returns the roof to its original position and closes the boot lid.

Keyless-Go Comfort Package with hands-free boot access (optional; standard on SL 65 AMG). Keyless-Go allows you to open and start the car without needing to reach for the car key. As long as you have the Keyless-Go remote on you, you simply touch the door handle to unlock the car. Once settled into your seat, just press the start/stop button to bring the engine to life. The package also includes a hands-free boot access function: simply place your foot beneath the rear and the sensor-controlled boot lid will be released or closed automatically.



Climate control and interior lighting

The right cabin climate makes for a relaxed, alert driver and a contented passenger. Which is why the SL lets each choose their own individual temperature settings.

Ambient interior lighting (optional; standard on SL 63 AMG and SL 65 AMG). The ambient interior lighting further enhances the cabin's sporty feel when driving at night. Comprising distinctive ambient lighting on the dashboard, in the doors and behind the seats, it is activated and deactivated when the headlamps are

switched on or off and also comes on when the door is opened, ensuring a warm welcome every time you return to the car. There are three colour settings to choose from – Solar, Solar Orange and Solar Red – each of which can be dimmed to achieve the desired brightness.

Luxury automatic climate control (standard). The two-zone luxury automatic climate control system maintains separate preset temperatures for each side of the cabin, compensating automatically for external influences such as sunlight, air quality and humidity in the process. By allowing driver and passenger to tailor the cabin climate to their needs, it ensures both enjoy optimum comfort and helps the driver to stay relaxed and alert at all times.



The automatic climate control system helps you maintain a pleasant cabin temperature in all weathers





Seats

The sports seats for the new SL are designed for the very highest standards of comfort and safety.

The SL's electrically heated sports seats offer excellent ergonomics and come with high side bolsters that ensure optimum support and a firm hold even in fast cornering. The seats are heated independently of each other, with a choice of three settings, and their warmth can be felt even before the cabin begins to heat up. You can even have different temperature settings for seat cushion and backrest. The seats come with full electric adjustment including electro-pneumatic 4-way lumbar adjustment and a memory function that enables you to store and recall the positions of the driver and passenger seat, the steering wheel and the exterior mirrors.

As well as supple, solar-reflective leather upholsteries that help you to stay cool in hot weather, the options include comfort-ventilated seats with perforated leather

and fans within the seats. The tiny perforations allow cooling air to pass through the seat surfaces, helping to prevent them from getting hot even under prolonged exposure to bright sunshine. Also available are optional multi-contour seats that help to reduce the load on the spine and can be tailored to suit different body shapes. The air pressure in the chambers within their side bolsters can be adjusted according to the needs of each occupant, as can the curvature of the backrest in the lumbar and shoulder area. The dynamic multi-contour seats in the optional Active Multi-Contour Seat Package offer all this and more: they also constantly adapt to changes in the car's lateral acceleration, help to reduce the risk of injuries in an accident, and can even massage your back while you drive.



The standard electric seat adjustment with memory function





The new sports seats combine outstanding comfort with optimum ergonomics and safety



SL 63 AMG

With its dramatic styling and race-honed technology, the SL 63 AMG is a roadster that's guaranteed to thrill. → www.mercedes-benz.co.uk/amg



The new SL 63 AMG combines exceptional performance and remarkable efficiency



The new SL 63 AMG says performance even at a standstill. Its muscular AMG bodystyling comprises side skirts, a front apron with side air vents and a rear apron with a body-colour diffuser-style insert, while AMG 5-twin-spoke alloy wheels further add to the dynamic look. The front apron's cross-bar, the bonnet and side fins, the two-bar AMG grille and the AMG-specific LED daytime running lights boast silver chrome trim and there are 'V8 BITURBO' badges on the front wings. At the rear, an AMG boot lid spoiler and an AMG sports exhaust system with two sets of chromed twin tailpipes complete the picture.

Climb inside and the racing feel is unmistakable, thanks to the combination of nappa leather-trimmed AMG Performance steering wheel with aluminium gear shift paddles, AMG Drive Unit with E-Select shift lever and AMG instrument panel with AMG start-up screen and Racetimer function for recording lap times. The nappa leather AMG sports seats feature model-specific stitching and are complemented by AMG carbon fibre interior trim and a black roof lining. Other eye-catching touches include an IWC-design analogue clock, ambient interior lighting and white-backlit AMG door sill panels in brushed stainless steel.



AMG sports seats in nappa leather



Centre console with AMG Drive Unit



AMG sports exhaust system with two sets of twin chromed tailpipes



SL 63 AMG technology

AMG 5.5-litre biturbo V8, AMG Speedshift MCT 7-speed sports transmission and AMG sports suspension: the SL 63 AMG is designed to thrill.

AMG 5.5-litre biturbo V8. The SL 63 AMG is designed to maximise performance without sacrificing fuel efficiency. It delivers an exhilarating sound and truly breathtaking acceleration, thanks to an output of 537 hp (395 kW) plus 800 Nm torque (564 hp [415 kW] and 900 Nm with the optional AMG Performance Package). The improvement in performance and efficiency are the result of innovative technology such as direct petrol injection, twin turbochargers and ECO start/stop function.



The AMG 5.5-litre biturbo V8 produces up to 564 hp (415 kW) and 900 Nm

For similarly impressive stopping power coupled with precise control, there are AMG high-performance composite brakes with internally ventilated, cross-drilled discs. The front discs are 390 × 36 mm; those at the rear measure 360 × 26 mm.

AMG Speedshift MCT 7-speed sports transmission.

This high-tech system combines the involvement and directness of a manual transmission with the comfort



The AMG Speedshift MCT 7-speed sports transmission offers smooth and rapid gear changes

and convenience of an automatic. With its choice of 'Controlled Efficiency', 'Sport', 'Sport Plus' and 'Manual' modes plus Racestart function, it lets you tailor the gear shifts to your mood and needs.

AMG sports suspension. Based on the Active Body Control (ABC) system, the AMG sports suspension can be set to either 'Comfort' or 'Sport' mode, with the settings of the AMG sports parameter steering also reflecting your chosen mode. Together the AMG sports suspension and steering systems deliver exceptional accuracy, agility and feedback, ensuring cornering is always a thrill.





ABC-based AMG sports suspension guarantees a perfect blend of agility and comfort



SL 65 AMG

The new SL 65 AMG is the epitome of luxury, exclusivity and power.



The SL 65 AMG combines exhilarating performance and exclusive luxury



In addition to the SL 63 AMG's muscular AMG bodystyling, the SL 65 AMG features differentiating details such as model-specific chromed twin tailpipes, 'V12 BITURBO' badges on the front wings and the front apron's high-gloss chromed cross-bar. The two-bar AMG grille, bonnet and side fins are also finished in high-gloss chrome, and there are 19" AMG 5-spoke alloy wheels as standard.

Inside, there's an unmistakable air of luxury, thanks to comfort-ventilated multi-contour seats, Exclusive Nappa leather upholstery with embossed 'AMG' backrest badges

and diamond-pattern stitching, and a Black *designo* leather roof lining. High-shine chrome AMG door sill panels with white backlighting guarantee an eye-catching welcome, while the Bang & Olufsen BeoSound AMG surround sound system provides a suitably high-end acoustic backdrop.

The SL 65 AMG's high-performance character, meanwhile, is further underlined by the nappa leather-trimmed AMG Performance steering wheel with aluminium shift paddles, the AMG Drive Unit and E-Select shift lever

with embossed 'AMG' badge, and the AMG carbon fibre interior trim.

The generous standard specification also includes telephone pre-wiring, Keyless-Go Comfort Package, Parktronic with Active Park Assist, Airscarf neck-level heating and a panoramic glass vario-roof with blind.



AMG sports seats in Exclusive Nappa leather with model-specific stitching



AMG instrument panel



AMG sports exhaust system with model-specific twin tailpipes



SL 65 AMG technology

Under the skin, the top-of-the-range SL roadster boasts an AMG 6-litre biturbo V12, AMG Speedshift Plus 7G-Tronic automatic transmission and AMG sports suspension.

AMG 6-litre biturbo V12. This high-performance V12 offers breathtaking performance allied to outstanding refinement. It delivers 630 hp (463 kW), gives you a mighty 1,000 Nm of torque all the way from 2,300 to 4,300 rpm and comes with ECO start/stop for enhanced fuel efficiency.

AMG Speedshift Plus 7G-Tronic automatic transmission. This four-mode transmission offers exceptionally dynamic gear shifts plus high levels of efficiency, while allowing you to tailor the shift characteristics to your needs via a rotary switch. It also offers automatic throttle-blipping during downshifts, which makes for a satisfyingly sporty sound and helps to reduce load transfer, especially when braking into bends.

AMG sports suspension. Like the SL 63 AMG, the SL 65 AMG features an AMG sports suspension based on Active Body Control (ABC), AMG sports parameter steering, and an AMG high-performance composite braking system with large internally ventilated and cross-drilled discs. Both models also feature Torque Vectoring Brake, which enhances roadholding and safety in sporty driving by distributing torque between the wheels as required.

Electronic Stability Programme (ESP®). The SL 63 AMG and SL 65 AMG both benefit from a selectable ESP® system that gives you added control over the handling characteristics. It offers a special 'Sport Handling' mode that can be activated via the ESP® button and also allows you to switch the system off entirely.



The SL 65 AMG is the first V12 Mercedes-Benz to feature AMG Speedshift Plus 7G-Tronic automatic transmission





The AMG 6-litre biturbo V12 generates 630 hp (463 kW) and 1,000 Nm of torque



AMG Performance Studio

With options from the AMG Performance Studio, you can add extra individuality to your AMG SL.

Available for the new SL 63 AMG, the AMG Performance Package features an engine upgrade that boosts the output by 27 hp (20 kW)¹ and increases maximum torque by 100 Nm as well as an increase in the electronically limited top speed and an improved 0-60 mph time.¹ It also adds a nappa leather/Dinamica[®] microfibre AMG Performance steering wheel, a carbon fibre rear spoiler and engine

cover, red brake calipers and an AMG rear axle limited slip differential. Other AMG Performance Studio options include striking 19"/20" AMG 10-spoke forged alloy wheels in either burnished Titanium Grey or matt black and AMG Performance suspension for the SL 63 AMG. The optional high-performance AMG ceramic composite braking system, meanwhile, not only delivers enhanced

stopping power and greater durability, it also improves agility and ride comfort by reducing unsprung mass. The AMG Driver's Package includes an increase in the electronically-limited top speed and attendance at an AMG 'Power & Passion' driving event.

¹Output: 564 hp (415 kW); max. torque: 900 Nm; acceleration 0-62 mph: 4.2 s; top speed: 186 mph



SL 63 AMG with AMG Performance Package



AMG 10-spoke forged alloy wheels



High-performance AMG ceramic composite brakes





The AMG Performance Package satisfies even the keenest of drivers



Standard equipment | Selection



Magic Vision Control, the world's first adaptive windscreen wash system



COMAND Online system with 6-disc CD/DVD changer



Intelligent Light System



Adaptive Damping System (ADS) with 'Sport' and 'Comfort' modes



Direct Select gear selector in the centre console



Multi-function sports steering wheel with nappa leather trim and gear shift paddles



Optional extras | Selection



Keyless-Go Comfort Package with hands-free boot access



Electric wind deflector



Airscarf neck-level heating system



Ambient lighting



Bang & Olufsen BeoSound AMG surround sound system



Panoramic glass vario-roof with Magic Sky Control



AMG Sports Package – exterior

The optional AMG Sports Package further enhances the SL's athletic look and feel.

For an even sportier SL 350 or SL 500, simply specify the optional AMG Sports Package. It adds muscular AMG bodystyling comprising front and rear aprons and side skirts, while 19" AMG 5-spoke alloy wheels further enhance the striking looks. The 7G-Tronic Plus transmission comes with an 'S' mode featuring modified shift points for a

more dynamic drive, and the 10-millimetre lower sports suspension offers firmer spring and damper settings (can be deleted as a no-cost option; not available in conjunction with ABC). The uprated brakes, meanwhile, feature drilled discs front and rear with grey calipers featuring 'Mercedes-Benz' lettering.



The AMG Sports Package's eye-catching rear apron



Burnished AMG 5-spoke alloy wheels

¹Available for SL 350 and SL 500





The AMG Sports Package makes for an even more muscular and exclusive SL



AMG Sports Package – interior

An SL with AMG Sports Package is as striking inside as out, thanks to a host of exclusive interior enhancements.

The AMG Sports Package adds a host of eye-catching extras to the interior too. They include a chequered flag-design instrument cluster, a flat-bottomed sports steering wheel with silver gear shift paddles and perforated leather in the grip area, plus either light or dark brushed aluminium trim, and AMG floor mats. The sports seats

feature black perforated leather with vertical fluting and have *designo* Platinum White Pearl piping on the seat side bolsters, head restraints, centre console and armrests¹ (nappa leather and Exclusive Nappa leather are available as options).



Chequered flag instruments



Black leather sports seats with *designo* Platinum White Pearl piping

¹ Standard with Black leather (code 211), also included with optional Black nappa and Black Exclusive Nappa leather (codes 811 and 511). Not included with alternative upholstery choices





Guaranteed to set pulses racing: the AMG Sports Package interior



designo

First-class materials, perfect craftsmanship and painstaking attention to detail make *designo* appointments a fine addition to any SL.

→ www.mercedes-benz.co.uk/designo

With *designo* interior appointments and paint finishes, you can lend your SL an even more exclusive look. In addition to sumptuous *designo* leather upholstery and Dinamica microfibre or leather roof linings, the range includes finely crafted *designo* interior wood trims in either Natural Bamboo, Black Piano Lacquer, Champagne

White Piano Lacquer or AMG carbon fibre. For the exterior, there's a choice of two *designo* metallic finishes, two *designo* Magno matt finishes or the glorious *designo* Zircon Red metallic. From harmonious elegance to striking contrasts, the possibilities are almost endless – and always truly special.



designo Black Piano Lacquer wood trim



designo leather roof lining



Red *designo* seat belts





Upholstery and trim



The Black interior scheme features Black leather with Dark Alpaca Grey stitching, nappa leather or Exclusive Nappa leather with Black top-stitching and Dark Alpaca Grey piping are available as options. The optional AMG Sports Package includes Black perforated leather with *designo* Platinum White Pearl piping as standard. Nappa leather and Exclusive Nappa leather are also available as options. For the SL 63 AMG there is nappa leather as standard and Exclusive Nappa leather as standard for the SL 65 AMG.



Black

- 201 (211) Leather^{1,2} (perforated³)
- 801 (811) Nappa leather^{4,5} (perforated^{4,6})
- 501 (511) Exclusive Nappa leather^{4,7} (perforated^{4,6})

Trim

- 739 Light brushed aluminium^{1,3,4}
- 731 Dark Brown Burr Walnut wood, high gloss^{2,4}
- H73 AMG carbon fibre^{4,5,7}
- 729 Light Brown Poplar wood, satin finish⁴
- 736 Black Ash wood, high gloss⁴
- H76 Dark brushed aluminium^{4,6}

¹Standard on SL 350 ²Standard on SL 500 ³Standard with AMG Sports Package (code 950) ⁴Optional ⁵Standard on SL 63 AMG ⁶Only in conjunction with AMG Sports Package (code 950) ⁷Standard on SL 65 AMG



The Crystal Grey interior scheme features Crystal Grey leather upholstery with Medium Grey contrast stitching as standard for the SL 350 and SL 500.

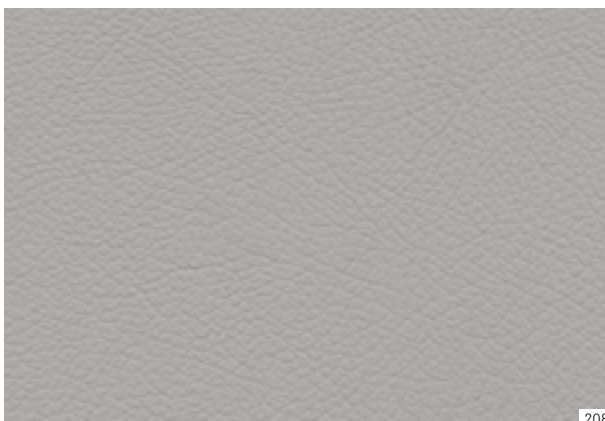

208



739



731



H73



729



736



H76

Crystal Grey

208 Leather^{1,2}

Trim

739 Light brushed aluminium^{1,3,4}

731 Dark Brown Burr Walnut wood, high gloss^{2,4}

H73 AMG carbon fibre^{4,5,6}

729 Light Brown Poplar wood, satin finish⁴

736 Black Ash wood, high gloss⁴

H76 Dark brushed aluminium^{4,7}

¹Standard on SL 350 ²Standard on SL 500 ³Standard with AMG Sports Package (code 950) ⁴Optional ⁵Standard on SL 63 AMG ⁶Standard on SL 65 AMG ⁷Only in conjunction with AMG Sports Package (code 950)



The Ginger Beige/Espresso Brown interior scheme features leather as standard, or optional nappa leather or Exclusive Nappa leather upholstery in Ginger Beige with Como Beige contrast stitching. The nappa leather and Exclusive Nappa leather versions have Espresso Brown piping for an even more elegant look. For the SL 63 AMG there is nappa leather as standard, and Exclusive Nappa leather as standard for the SL 65 AMG.



205

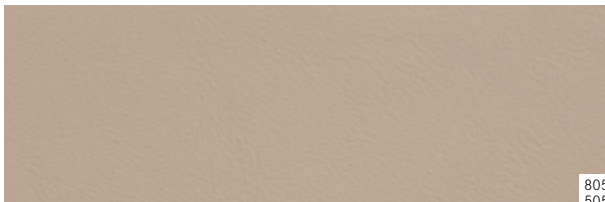

805
505



739



731



H73



729



736



H76

Ginger Beige/Espresso Brown

- 205 Leather^{1,2}
- 805 Nappa leather^{3,4}
- 505 Exclusive Nappa leather^{3,5}

Trim

- 739 Light brushed aluminium^{1,3,6}
- 731 Dark Brown Burr Walnut wood, high gloss^{2,3}
- H73 AMG carbon fibre^{3,4,5}
- 729 Light Brown Poplar wood, satin finish³
- 736 Black Ash wood, high gloss³
- H76 Dark brushed aluminium^{3,7}

¹Standard on SL 350 ²Standard on SL 500 ³Optional ⁴Standard on SL 63 AMG ⁵Standard on SL 65 AMG ⁶Standard with AMG Sports Package (code 950) ⁷Only in conjunction with AMG Sports Package (code 950)





The Porcelain interior scheme features either nappa leather or Exclusive Nappa leather upholstery in Porcelain. The seats have Black piping with Porcelain top-stitching. For the SL 63 AMG there is nappa leather as standard, and Exclusive Nappa leather as standard for the SL 65 AMG.

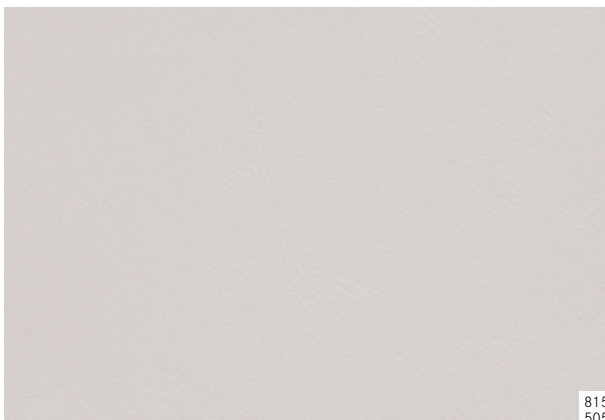

815
505



739



731



H73



729



736



H76

Porcelain

- 815 Nappa leather^{1,2}
- 515 Exclusive Nappa leather^{1,3}

Trim

- 739 Light brushed aluminium^{1,4,5}
- 731 Dark Brown Burr Walnut wood, high gloss^{1,6}
- H73 AMG carbon fibre^{1,2,3}
- 729 Light Brown Poplar wood, satin finish¹
- 736 Black Ash wood, high gloss¹
- H76 Dark brushed aluminium^{1,7}

¹Optional ²Standard on SL 63 AMG ³Standard on SL 65 AMG ⁴Standard on SL 350 ⁵Standard with AMG Sports Package (code 950) ⁶Standard on SL 500 ⁷Only in conjunction with AMG Sports Package (code 950)



The Bengal Red interior scheme features leather, nappa leather or Exclusive Nappa leather upholstery in Bengal Red with Black contrast stitching. The nappa leather and Exclusive Nappa leather versions also have Black piping for an even more elegant look. For the SL 63 AMG there is nappa leather as standard, and Exclusive Nappa leather as standard for the SL 65 AMG.



207



807
507



739



731



H73



729



736



H76

Bengal Red

- 207 Leather^{1,2}
- 807 Nappa leather^{3,4}
- 507 Exclusive Nappa leather^{3,5}

Trim

- 739 Light brushed aluminium^{1,3,6}
- 731 Dark Brown Burr Walnut wood, high gloss^{2,3}
- H73 AMG carbon fibre^{3,4,5}
- 729 Light Brown Poplar wood, satin finish³
- 736 Black Ash wood, high gloss³
- H76 Dark brushed aluminium^{3,7}

¹Standard on SL 350 ²Standard on SL 500 ³Optional ⁴Standard on SL 63 AMG ⁵Standard on SL 65 AMG ⁶Standard with AMG Sports Package (code 950) ⁷Only in conjunction with AMG Sports Package (code 950)

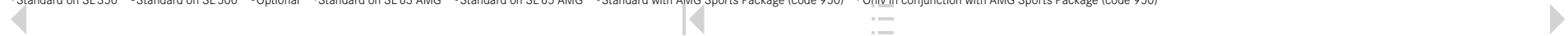



The Nut Brown interior scheme features nappa leather or Exclusive Nappa leather upholstery in Nut Brown with Black piping and contrast stitching.

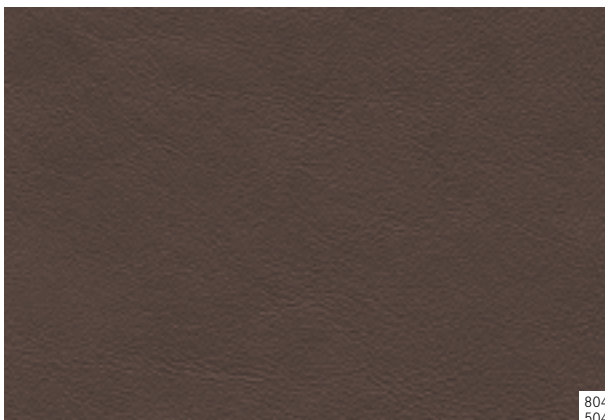

804
504



739



731



H73



729



736



H76

Nut Brown¹

- 804 Nappa leather²
- 504 Exclusive Nappa leather²

Trim

- 739 Light brushed aluminium^{2,3,4}
- 731 Dark Brown Burr Walnut wood, high gloss^{2,5}
- H73 AMG carbon fibre²
- 729 Light Brown Poplar wood, satin finish²
- 736 Black Ash wood, high gloss²
- H76 Dark brushed aluminium^{2,6}

¹ Not available on SL 63 AMG and SL 65 AMG ² Optional ³ Standard on SL 350 ⁴ Standard with AMG Sports Package (code 950) ⁵ Standard on SL 500 ⁶ Only in conjunction with AMG Sports Package (code 950)



Alloy wheels



18" 5-twin-spoke alloy wheels, burnished Vanadium Silver finish (standard on SL 350 and SL 500, code R70)



19" AMG 5-spoke alloy wheels, burnished finish (code 770). Part of optional AMG Sports Package (code 950)



19" 5-twin-spoke alloy wheels, Vanadium Silver finish (optional on SL 350 and SL 500, code R17)



19" AMG 5-twin-spoke alloy wheels, painted in Titanium Grey (standard on SL 63 AMG, code 793)





19" AMG 5-spoke alloy wheels, burnished Titanium Grey finish
(standard on SL 65 AMG, code 797)



19"/20" forged AMG 10-spoke alloy wheels, Matt Black finish with
burnished rims (optional on AMG models, code 767)



19"/20" forged AMG 10-spoke alloy wheels, polished Titanium Grey finish
(optional on AMG models, code 766)



Retailer-fit accessories

Custom-designed for the new SL, our Retailer-fit accessories are the perfect way to make your roadster sportier and even more practical.

→ www.mercedes-benz.co.uk/accessories



Eye-catching Retailer-fit 18" 5-spoke alloy wheels



Give your SL a truly individual look – with styling accessories such as Retailer-fit alloy wheels – or enhance its comfort and convenience with practical extras such as the iPhone® console. In conjunction with the telephone pre-wiring option it automatically connects your phone to the car's hands-free facility, enabling you to operate your iPhone® via the car's controls, while offering optimum reception, charging the battery and giving you access to files stored on the phone. Consoles are also available for a range of other popular handsets.



iPhone® console

For a whole new in-car communications experience, there's the Mercedes-Benz telephone module with Bluetooth® (SAP) and 3G capability. It connects directly to the car's external aerial, providing a fast, stable and secure Internet connection for the COMAND Online system. It also enables you to make calls, use Mercedes-Benz apps via COMAND Online and have your text messages read out to you. The telephone works in conjunction with the optional telephone pre-wiring concealed within the centre armrest.



Food-safe shallow boot tub

The practical shallow boot tub is precision-tailored to the load area of the SL. It is easy to clean, has a studded surface to prevent loads from sliding around and is made of food-safe material.

All our Retailer-fit accessories offer the very highest standards of quality and safety. For more details, please see the relevant brochure or speak to your local Mercedes-Benz Retailer.



Services

Test drive. Words can only do so much. Some things have to be experienced to be truly appreciated. Which is why we'd like to invite you for a test drive. Feel the power of efficient engines that offer impressive fuel consumption. Feel exhilarated by precise steering, designed to connect the driver with the road and enjoy sumptuous levels of comfort. Your Mercedes-Benz Retailer will be happy to make arrangements for you to experience the things that set a Mercedes-Benz apart. Alternatively, to request a test drive online simply visit www.mercedes-benz.co.uk/testdrive We look forward to seeing you.

Mercedes-Benz Finance. At Mercedes-Benz Finance, our single-minded aim is to provide optimum financial solutions for all those who share the Mercedes-Benz philosophy of absolute commitment to quality. Whether you are a private customer or a business user, our finance and leasing packages can be tailored to meet your individual needs. For further information on Mercedes-Benz Finance, please contact your local Mercedes-Benz Retailer.



Mercedes-Benz Insurance offers a fully comprehensive 5-star-rated¹ Motor Insurance policy specifically designed to provide the cover you would expect from Mercedes-Benz. For a quotation, please call 0845 600 2180²

Interactive Owner's Manual. The website also offers an interactive tour, enabling you to take a closer look at your desired model. This simulation is the ideal way to acquaint yourself with your dream car. You can view key functions in detail, gain an insight into the car's inner workings or look at the benefits of each model. For further details, visit www.mercedes-benz.co.uk/slclassmanual



Roadside Assistance. Rest assured that should you ever need help, Mercedes-Benz Roadside Assistance is there for you. In the unlikely event of a technical breakdown³ you can rely on the Mercedes-Benz Roadside Assistance Team – anywhere in Europe. Simply phone our Customer Assistance Centre on 00800 1 777 7777,⁴ where our specialists will organise assistance for you. Mercedes-Benz will also assist you in the event of a minor mishap preventing you from driving your vehicle³. Whether you lose your key, run out of fuel or your vehicle is damaged due to an accident or vandalism, Mercedes-Benz ensures that you still reach your destination. Often the problem can be rectified on the spot, but if this is not possible, we will naturally ensure that your vehicle is taken to the nearest Mercedes-Benz Official Workshop to get you back on the road as quickly as possible.

¹ As rated by Defaqto, a leading UK independent financial research company.

² Mercedes-Benz Motor Insurance is underwritten by Aviva Insurance Limited. Calls are charged at local rate and may be recorded. We may decline to quote in some circumstances.

Mercedes-Benz World at Brooklands. Celebrate the story of Mercedes-Benz and you'll celebrate the story of motoring itself at Mercedes-Benz World in Surrey. Discover Mercedes-Benz racing heritage, from its connections to the famous Brooklands circuit through to present-day Formula 1™ brought to life in the most sensational way. View, touch and sit in every car from the Mercedes-Benz range, and encounter automotive legends like the 'Gullwing' and many other classic icons, in the UK's largest Mercedes-Benz showcase. Then set your pulse racing by booking one of our thrilling Driving Experiences. Enjoy AMG performance on the purpose-built Handling Circuits or Wet Skid Circle, an axle-twisting off-road adventure, or treat your kids over 1.5 metres tall to their own driving experience in an A-Class or on the off-road terrain in an M-Class.

³ Cover is initially valid for your vehicle for four years from the date of first registration. This can be extended from the fifth year, up to a maximum of 30 years, on completion of each scheduled maintenance service, providing that this service is carried out by a Mercedes-Benz

And for kids even younger and under 1.3 metres tall, let them be a 'Little Learner' in their own miniature electric version of the desirable Mercedes-Benz SL. For more interactive action, take a virtual 3D journey along the production line in 'Build' and take a seat in the cinema to accelerate from the birth of the car to the latest innovations in 20 eye-opening minutes.

Relax and refuel in Café 1886, or for something more enjoy the delicious menu and elegant surroundings of the Gullwing Restaurant. Finally, extend your visit with a short stroll to Brooklands Museum to see their collection of classic cars, aviation exhibitions – and the legendary Concorde. For more information visit www.mercedes-benzworld.co.uk

Official Workshop. Minor mishap cover is provided at the absolute discretion of Mercedes-Benz
⁴In non-affiliated European countries: +44 20 7975 7077



Dimensions

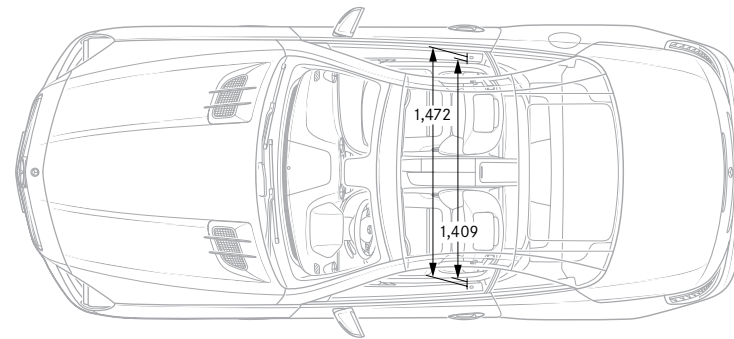
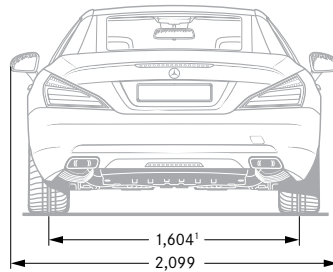
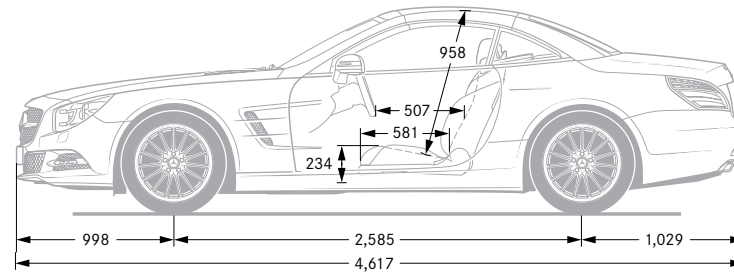
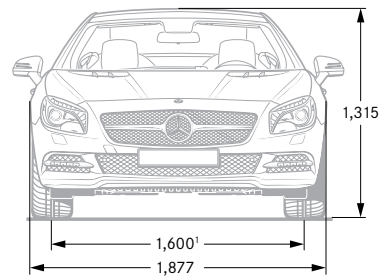

All measurements in millimetres. The dimensions shown are mean values and apply to standard-specification, unladen vehicles
¹With two occupants of 68 kg each



Technical data

	Petrol engines	
	SL 350	SL 500
Arrangement/cylinders/valves	V/6/24	V/8/32
Total displacement – cc	3,498	4,663
Rated output ¹ – hp (kW) at rpm	306 (255)/6,500	435 (320)/5,250
Rated torque ¹ – Nm at rpm	370/3,500–5,250	700/1,800–3,500
Acceleration 0–62 mph – sec	5.9	4.6
Top speed, approx. – mph	155 ³	155 ³
Fuel consumption ⁴ – mpg		
Urban	28.5	22.1
Extra-urban	46.3	39.8
Combined	37.7	30.7
CO ₂ emissions, combined ⁴ – g/km	176–169	214–212
EU emissions standard	Euro 5	Euro 5
Fuel tank capacity/of which reserve – l	65/8.0	65/8.0
Boot capacity – l		
with roof closed	504	504
with roof open	364	364
Turning circle – m	11.04	11.04
Kerb weight ⁵ /Perm. Gross Vehicle Weight – kg	1,685/2,065	1,785/2,165

¹Figures in accordance with Directive 80/1269/EEC in the currently applicable version ²Figures in square brackets relate to AMG Performance Package ³Electronically limited

⁴The figures shown were obtained in accordance with the prescribed measuring process (Directive EC 715/2007 in the currently applicable version). The figures are not based on an individual model and do not constitute part of the product offer; they are provided solely for purposes of comparison between different vehicle models

⁵Figures according to Directive 92/21/EC, version 95/48/EC (kerb weight with fuel tank 90% full, driver, 68 kg, and luggage, 7 kg) for standard-specification vehicles. Optional extras and accessories will generally increase this figure and reduce the payload capacity accordingly

⁶In conjunction with AMG Driver's Package

For further technical data, please visit www.mercedes-benz.co.uk



	Petrol engines	
	SL 63 AMG	SL 65 AMG
Arrangement/cylinders/valves	V/8/32	V/12/48
Total displacement – cc	5,461	5,980
Rated output ¹ – hp (kW) at rpm	537 (395)/5,500 [564 (415)/5,500 ²]	630 (463)/4,800
Rated torque ¹ – Nm at rpm	800/2,000–4,500 [900/2,250–3,750 ²]	1,000/2,300–4,300
Acceleration 0–62 mph – sec	4.3 [4.2 ²]	4.0
Top speed, approx. – mph	155 ³ [186 ^{2,4}]	155 ³ (186 ⁴)
Fuel consumption ² – mpg		
Urban	20.3	16.6
Extra-urban	37.2	33.6
Combined	28.5	24.4
CO ₂ emissions, combined ⁴ – g/km	231–231	270–270
EU emissions standard	Euro 5	Euro 5
Fuel tank capacity/of which reserve – l	75/14	75/14
Boot capacity – l		
with roof closed	504	504
with roof open	364	364
Turning circle – m	11.1	11.1
Kerb weight ⁵ /Perm. Gross Vehicle Weight – kg	1,845/2,180	1,950/2,210

¹Figures in accordance with Directive 80/1269/EEC in the currently applicable version ²Figures in square brackets relate to AMG Performance Package ³Electronically limited

⁴The figures shown were obtained in accordance with the prescribed measuring process (Regulation [EC] 715/2007 in the currently applicable version). The figures are not based on an individual model and do not constitute part of the product offer; they are provided solely for purposes of comparison between different vehicle models

⁵Figures according to Directive 92/21/EC, version 95/48/EC (kerb weight with fuel tank 90% full, driver, 68 kg, and luggage, 7 kg) for standard-specification vehicles. Optional extras and accessories will generally increase this figure and reduce the payload capacity accordingly

⁶In conjunction with AMG Driver's Package

Paint finishes

Non-metallic paints



040



590

Non-metallic paint (no-cost option)

- 040 Black
- 590 Fire Opal

Metallic paint (standard)

- 183 Magnetite Black
- 197 Obsidian Black
- 281 Cerussite Grey (matt finish)²
- 526 Dolomite Brown
- 755 Tenorite Grey
- 775 Iridium Silver
- 792 Palladium Silver
- 794 Pearl Beige
- 799 Diamond White¹
- 890 Cavansite Blue

designo special paint² (optional)

- 057 designo Zircon Red

designo special paint



057

Metallic paints



183

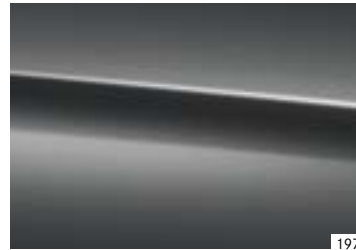

197



281



526

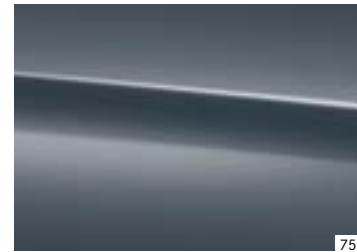

755

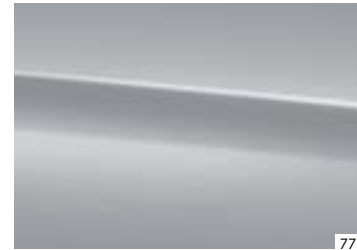

775

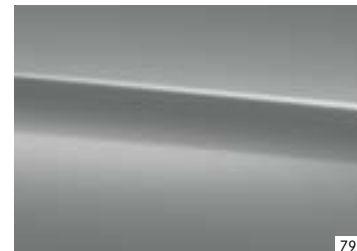

792



794



799



890

Other finishes available from the designo options range.
¹ Additional cost option ² Special order only



Take-back of end-of-life vehicles. Coming full circle. At the end of its long life, you can return your SL-Class to us for environment-friendly disposal in accordance with the EC End-of-Life Vehicle Directive.¹ But that day lies a long way off.

¹Applies in accordance with national regulations to vehicles up to 3.5 t permissible gross weight. The SL-Class has met the statutory regulations governing the suitability of the vehicle's design for reuse and recycling for a number of years now. A network of vehicle take-back depots and dismantlers has been established which will process your vehicle in an environment-friendly manner. The ways in which both vehicles and parts can be recovered are subject to ongoing development and improvement. Consequently, the SL-Class will be able to comply with any future increases in the recycling quota within the stipulated time limits. Further information is available at www.mercedes-benz.co.uk or by calling 0808 156 6606.

Please note: this online version of the printed brochure may contain abridged copy or other content changes. The manufacturer reserves the right to make changes to the design, form, colour and specification during the delivery period, provided these changes, while taking into account the interests of the vendor, can be deemed reasonable with respect to the purchaser. Where the vendor or the manufacturer uses symbols or numbers to describe an order or the subject of an order, no rights may be derived solely from these. The illustrations may show accessories and items of optional equipment which are not part of standard specification. Colours may differ slightly from those shown in the brochure, owing to the limitations of the printing process. This brochure has been compiled by Daimler AG of Germany and is distributed internationally. It provides a general indication of the range of models, features, optional extras and/or colours available in various countries. Some of the models, features, optional extras and/or colours shown may not be available in your country or may only be available in a different specification. Additionally some models, features, optional extras and/or colours may only be available in combination with others. For current and more specific information in relation to the range of models, features, optional extras and/or colours available in your country, and their pricing, you should contact your nearest authorised Mercedes-Benz Retailer. E&OE. www.mercedes-benz.co.uk

