

---

# Ford Falcon '62

*BEST SHAPE ECONOMY'S EVER BEEN IN*

---

Count all the wonderful ways Falcon is new. **NEW STYLING:** crisp, smart new looks all around. **NEW MODELS:** 13 in all, headlined by the distinctive Falcon Squire (below left), newest idea in compact wagon luxury; a sparkling new Falcon Futura (below right), a new Falcon Station Bus and two new Falcon Club Wagons (see pgs. 10 & 11). **NEW LUXURY:** 25 interior trim choices of long-wearing nylons and leather-like vinyls. **NEW GAS SAVINGS:** new improved version of the famous Falcon Six engine that in '61 got the greatest mileage *ever* for a "6" or "8" in the history of the Mobilgas Economy

Cover: FALCON FORDOR SEDAN  
in Corinthian White with Deluxe trim

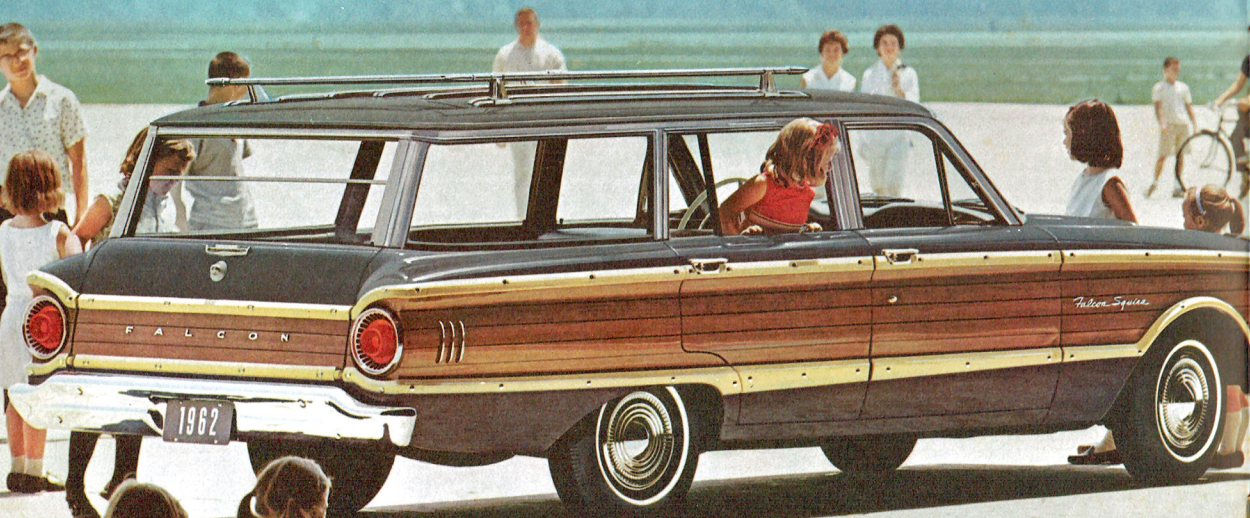

FALCON SQUIRE in Raven Black

Run (see pgs. 18 & 19). **NEW OIL SAVINGS:** super-screening Full-Flow Oil Filter helps you go 6,000\* miles between oil changes. **NEW ALL-AROUND ECONOMY:** fuel filter now goes 30,000 miles between changes. New coolant which means normally no need to change permanent antifreeze for two years or 30,000 miles. **FAMOUS LOW PRICE:** Falcon—for two years America's lowest-priced 6-passenger car—retains its traditionally low price in '62! So—add up all the ways Falcon is new. Then see all the news in Falcon for '62 (and all the latest news in compacts) at your Ford Dealer's.

\*For Station Bus and Club Wagons, see page 10



FALCON FUTURA in Corinthian White

© 1961 Ford Motor Co.,  
Dearborn, Michigan

Falcon for '62: More from the car America loves most! More models, more savings, more everything!



**Standard Sedan Interior.** This Falcon front seat of smart nylon pattern cloth edged in vinyl tells you who sets the standards in compact car style, comfort and convenience. It's foam-cushioned, wide and deep, for solid comfort. Mighty durable and easy to keep clean. Falcon's steering wheel is 3-spoke, deep-dish safety design and comfortably 17 inches big. In every Falcon you get *two* sun visors, *two* front arm rests . . . even *two* coat hooks. And, just see how wide that Falcon front door opens to welcome you and five other folks inside!

#### FALCON SEDAN STANDARD EQUIPMENT

Falcon Six Engine (144-cu. in.) \ 3-Speed Manual Transmission \ Rotunda Full-Flow Oil Filter \ Fully Aluminized Muffler \ Zinclad Rocker Panels and Main Underbody Structural Members \ Bright-Metal Windshield, Rear Window and Drip Rail Moldings \ Parallel Action Windshield Wipers \ Dual Horns \ Foam-Cushioned Front Seat \ Dual Front Arm Rests and Sun Visors \ Coat Hooks \ Deep-Dish 3-Spoke Steering Wheel \ Body, Roof, Hood and Dash Insulation \ Seat Belt Anchors \ 30,000-Mile Fuel Filter \ 30,000-Mile or 2-Year Permanent Antifreeze \ (For Options and Accessories, see page 16.)

**More miles on less gas** than ever before recorded by a "6" or "8" in the 25-year history of the Mobilgas Economy Run! That's what Falcon's standard 144 Six with manual transmission did in '61 against a full field of expert drivers. Now this famous engine has been improved—the peppery 170 Special Six option has been, too! What more could be said for economy!



FALCON TUDOR SEDAN in Silver Moss with standard trim (Offered also in Fordor model)

**TUDOR SEDAN.** Here's the car whose standard equipment list has set the standards for all other compacts. And, if you compare Falcon features from the list opposite against the field, you'll see the other compacts aren't "up to standard" yet! \ Actually, Falcon has many more items that could be added to the list. For example—a big one—6-passenger comfort. And that means, naturally, room for heads and shoulders, hips and legs. Another item, economy. Falcon gas savings have broken long-standing records. But even more important are the savings when you buy. For Falcon retains its traditionally low price in '62! (Costs less to license and—in most states—insure, too.) \ And this is just a good beginning. For more, talk to any Falcon owner.

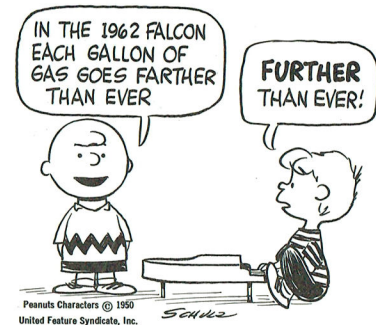

Peanuts Characters © 1950  
United Feature Syndicate, Inc.

Schulz



### FALCON SEDAN DELUXE TRIM

Includes most Standard Equipment listed on page 4 plus the following Deluxe trim package . . .  
 Bright-Metal Window Frames, Rear Quarter Trim and Side Moldings \ Fender Top Ornaments \ Choice of Seven Pleated Nylon and Vinyl or All-Vinyl Interior Trims \ Rich, Color-Keyed, Wall-to-Wall Carpeting \ Arm Rests and Ash Trays, Front and Rear \ Cigarette Lighter \ Deluxe White Steering Wheel with Chrome Horn Ring \ Dome Light Operated by Front Door Courtesy Switches \ (For Options and Accessories, see page 16.)

**Big Falcon trunk**—big enough to carry all the luggage of the six happy folks riding up front. Measures 23.7 cubic feet in all. So easy to load and so convenient (flat, wide space and all in one place)! Another kind of convenience is Falcon's Center-Fill fueling (fuel port shown in lower trunk sill). Makes filling easy from either side.

**Deluxe Sedan Interior.** Rich turquoise in deep-pleated nylon inserts and vinyl seat bolsters is one of seven stunning trim choices. The headlining is of snow-white vinyl; below, color-keyed nylon-rayon loop carpet stretches wall to wall. Many Falcon owners who "go deluxe" also specify optional color-keyed padded instrument panel and white padded visors shown here. They enhance interior styling as they add to the safety of front seat passengers. Radio and heater (shown in instrument panel) are the most highly favored Falcon options.

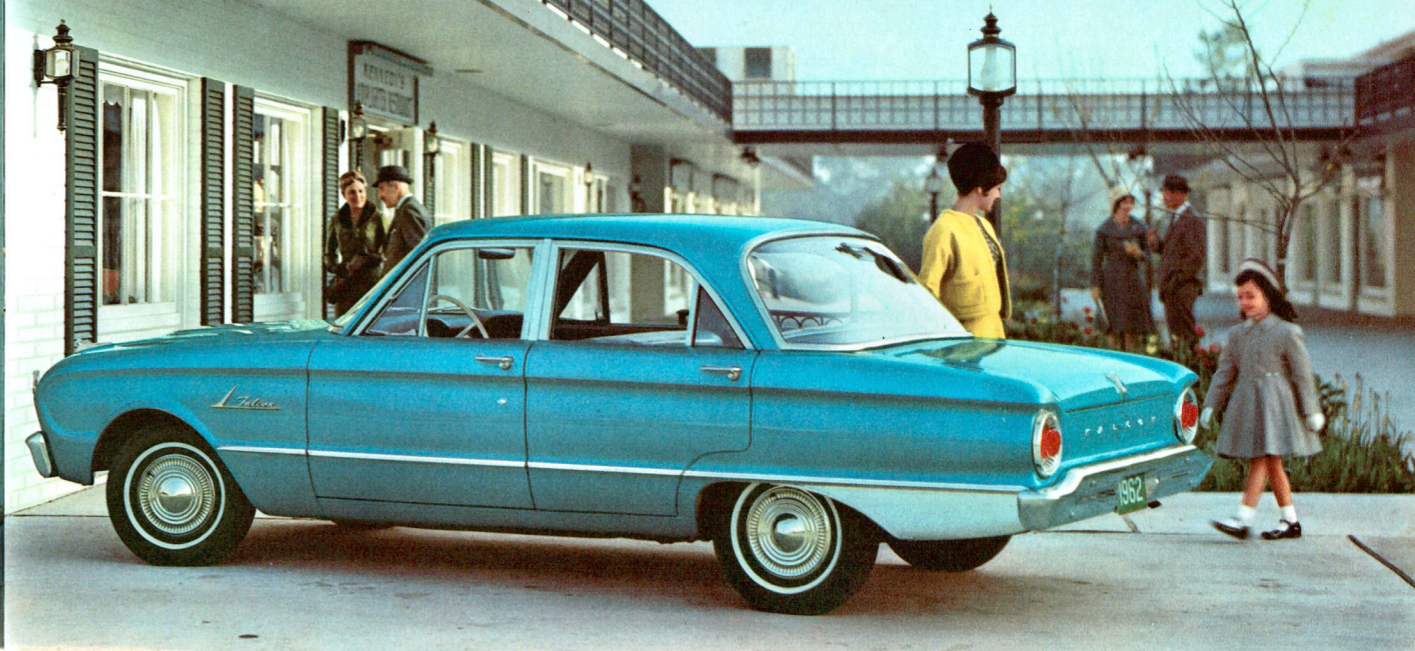
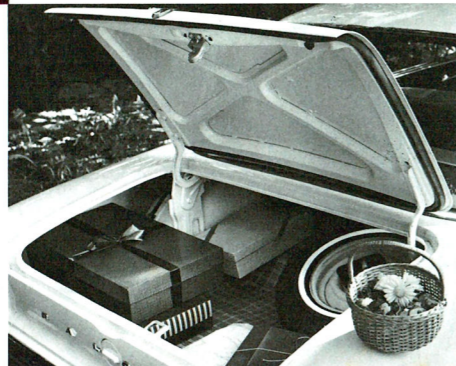

FALCON FORDOR SEDAN in Ming Green with Deluxe trim (Offered also in Tudor model)

**FORDOR SEDAN.** Nearly 65% of all Falcon buyers order their cars with Deluxe trim, like the one above. Still, these folks came to Falcon first for savings. And they were as pleased as they were amazed to find a Falcon with full Deluxe trim (listed opposite) actually costs less than many other compacts with standard trim! \ Even in their Deluxe models some other compacts do not offer at any price features which are standard on every Falcon. Examples: sturdy one-piece, deep-section bumpers. Bolt-on front fenders (less for replacement). Zinclad underbody members (rust protection). 6,000 miles between oil changes, 30,000-mile fuel filter (less for service). \ Nearly 750,000 Falcons already on the road prove people find more of what they want from a compact in a Falcon!



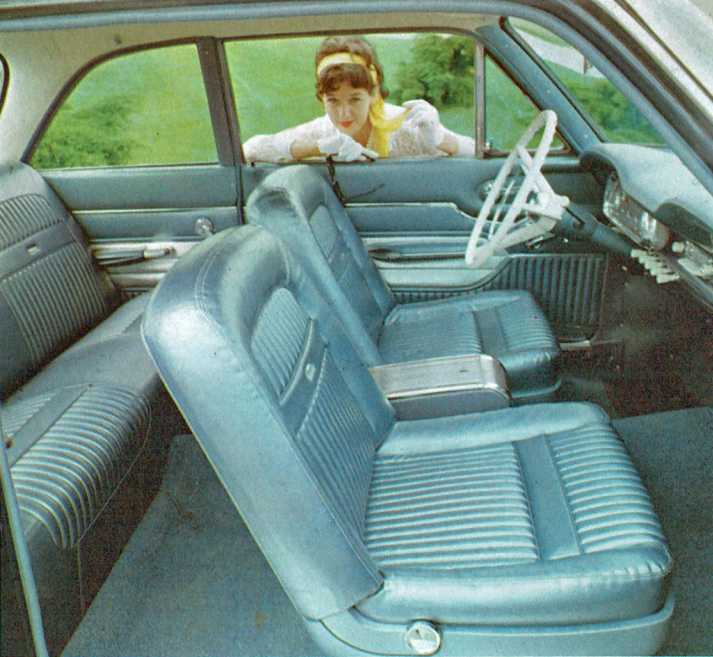

#### FUTURA STANDARD EQUIPMENT

*Includes most Standard Equipment and Deluxe trim items listed on pages 4 and 6, plus...*

Individually Contoured Front Seats (100% foam-rubber-padded cushions and backs) \ Between-the-Seats Console \ All-Vinyl Interior in Choice of 5 Colors \ White Vinyl Headlining \ Deluxe Arm Rests and Ash Trays, Front and Rear \ Distinctive Bright-Metal Trim Includes: Emblem on Glove Compartment Door, Louver Front Fender Side Ornament, Side Spear, Rear Quarter "Futura" Script, and "Futura" in Block Letters on Rear Panel \ Vented Full Wheel Covers

**The Console**—a Futura luxury... a Thunderbird inspiration. Nestled between the front seats, conveniently at finger tips of driver and passenger alike. At a touch the lid opens to reveal a personal storage compartment. It's big enough for your camera, sunglasses, maps, gloves, or other travel items you like to keep close at hand.

**Futura Interior.** Individual front seats are elegantly pleated, contoured and cushioned in foam rubber for superb comfort. Each adjusts individually... folds far forward to accommodate those in the rear. Rear seat is styled with the same deep-pleated, custom-tailored look. Yet it's full-width to comfortably seat three. You can choose from five all-vinyl interiors; this is metallic blue. Any wonder why this one's called "compact cousin of the Thunderbird?"

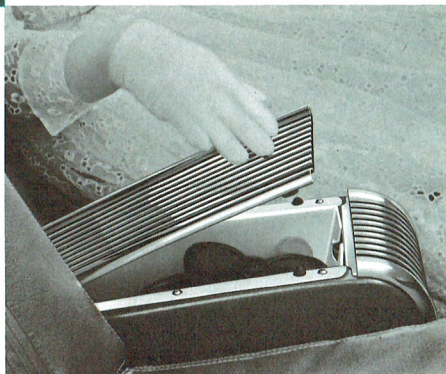

FALCON FUTURA in Oxford Blue

**FUTURA.** One of the best-shaped "packages" economy's ever been in! Certainly the most luxurious (details opposite) and one of the most delightful to drive. Here is the happiest, most spirited "going" among compacts—a beautiful blend of power and top gas savings in the Falcon Six engine, or, if you prefer, the extra zip and dash of the 170 Special Six option. The handling (such ease and precision!) would win praise from many a sports car fan. There's only one way to describe the ride and that's "big-car" all the way! Best of all, this fun-car performance is yours not only in Futura but in every other Falcon sedan as well! One more big reason why Falcon is the car America loves most!



## Three New Falcons join the family

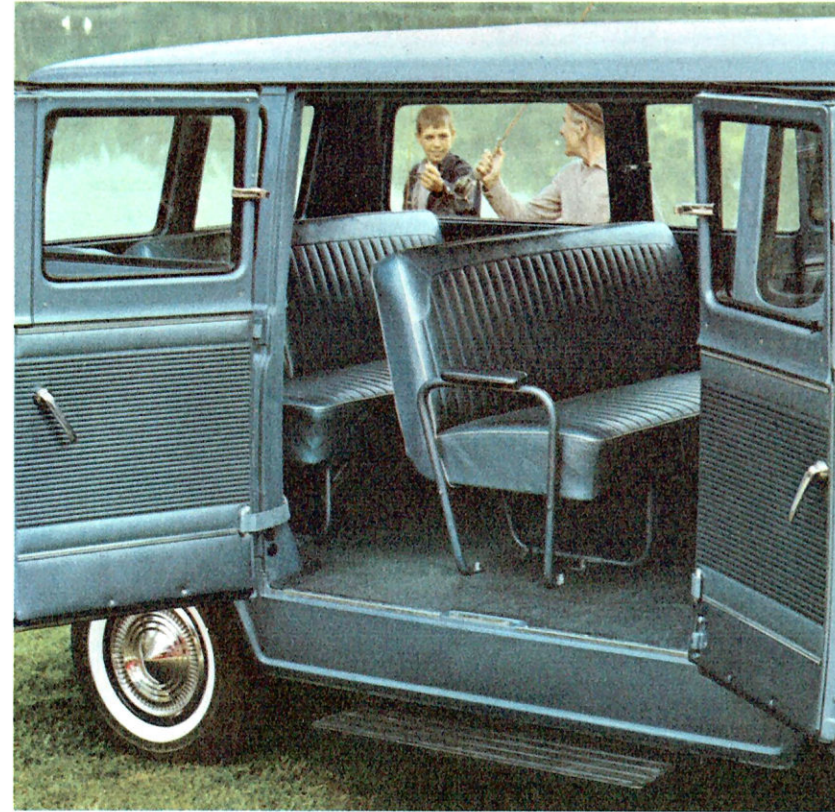

**Deluxe Club Wagon Interior.** Walk right in with the whole gang! Big double doors swing back to give you a side opening 49.4 inches wide. Auxiliary step slides out to meet you as doors are opened. Individual seats up front for driver and passenger, two 3-passenger seats behind. All foam-cushioned and chair-height—that's solid comfort for eight in the style of Falcon's new Deluxe Club Wagon. Two-tone pleated vinyl trim scheme is carried through seats, doors and side panels.

THE NEW FALCON CLUB WAGON IS JUST ONE OF 13 NEW MODELS FOR '62



SORT OF AN AUTOMOTIVE BAKER'S DOZEN!

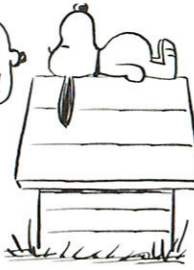

They're named Station Bus, Club Wagon and Deluxe Club Wagon. Biggest Falcons by far, they can carry up to eight passengers or 204 cubic feet of cargo. So wonderfully versatile, too—they're as much at home on a vacation camping trip, a shopping trip or the twice-daily trip to school. They're as thrifty and economical as any member of the Falcon family and among the *lowest* in price.

### STANDARD EQUIPMENT\*

#### Falcon Station Bus

Falcon Six Engine (144-cu. in.) \ 3-Speed Manual Transmission \ Single-Speed Electric Windshield Wipers \ Deep-Dish 3-Spoke Steering Wheel \ Foam-Cushioned Front Seats \ Seat Belt Anchors \ Auxiliary Side Step \ Zinclad Main Underbody Structural Members \ 30,000-Mile or Two-Year Permanent Antifreeze \ Rotunda Full-Flow Oil Filter (4,000-mile oil change) \ 8,000-Mile Fuel Filter

#### Falcon Club Wagon

All the above equipment *plus* . . . Full-Length Floor Mat and Headlining \ Cigarette Lighter \ Black Steering Wheel with Chrome Horn Ring \ Dual Horns and Sun Visors \ Front Arm Rests \ Coat Hooks \ Right-Hand Air Inlet

#### Falcon Deluxe Club Wagon

All Station Bus and Club Wagon equipment above *plus* . . . Falcon 170 Special Engine (replaces 144-cu. in. Six) \ Second and Third Seats with Arm Rests and Ash Trays† \ Blue Deluxe Steering Wheel with Chrome Horn Ring \ Padded Instrument Panel and Sun Visors \ Pleated, All-Vinyl Upholstery and Side Trim Panels \ Dual Dome Lamps \ Chrome Hub Caps

\*See your Ford Dealer for complete information on equipment, options and accessories  
†Optional equipment factory-installed



FALCON DELUXE CLUB WAGON in Viking Blue

**DELUXE CLUB WAGON.** Here's the one that most deserves to be called the "family Falcon." It seats eight with ease or takes 204 cubic feet of cargo. Huge double doors at curbside and rear for easy loading and unloading. Trim 90-inch wheelbase gives you the smallest turning circle, tightest maneuverability of all Falcons! An economical way with gas and oil that can only be compared to other Falcons. Visibility is so generous everyone has a window of his own! If yours is a big family that likes to go places together, this family Falcon (or one of the two like it) was made for you!

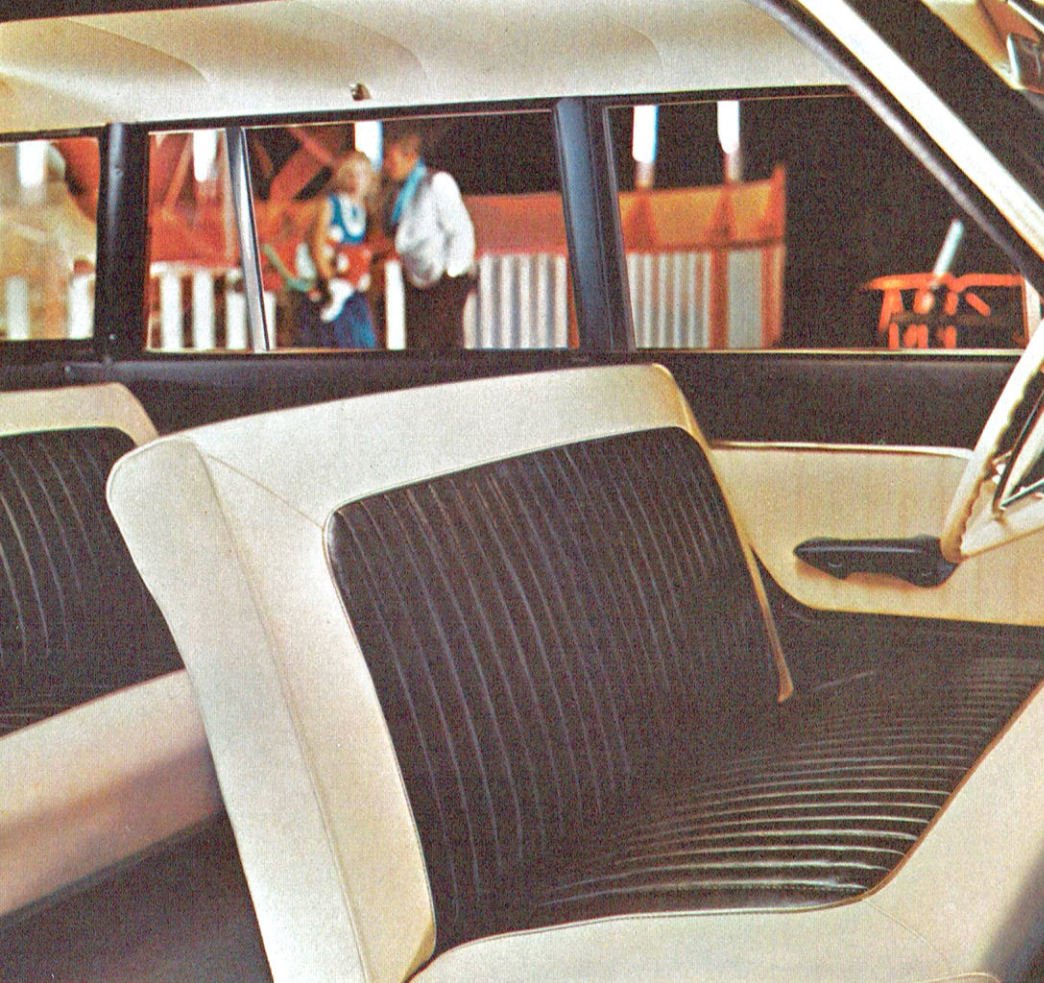

### FALCON WAGON STANDARD EQUIPMENT

Includes Standard Equipment listed on page 4 plus these special wagon features . . .

All-Vinyl Seat Trim with Light Beige Bolsters, "Steerhead" Pattern in Medium Beige Inserts \ Foam-Cushioned Seats, Front and Rear \ Roll-Down Tailgate Window \ Rubber Cargo Mat (black)

### FALCON WAGON DELUXE TRIM

Includes most equipment on page 4 and above plus the following Deluxe trim package . . .

Bright-Metal Side and Rear Window Frames, Rear Quarter Trim and Side Molding \ Fender Top Ornaments \ Choice of Three Pleated All-Vinyl Interiors, One Woven Plastic and Vinyl Interior \ Arm Rests and Ash Trays, Front and Rear \ Cigarette Lighter \ Deluxe White Steering Wheel with Chrome Horn Ring \ Dome Light Operated by Front Door Courtesy Switches \ Color-Keyed Mats. (For Options and Accessories, see page 16.)

**Loadspace** comes big and easy in a Falcon wagon! Second seat flips over quick as "1-2-3" to provide 76.2 cubic feet of loadspace. Behind the front seat, space measures almost 9 feet to end of open tailgate (over 7 feet with tailgate closed) and up to 4¾ feet from side to side. It's level, *all-in-one-place* loadspace, too!

**Deluxe Wagon Interior.** Falcon wagons outsell the rest because they clearly outclass any rival. Look at the luxury. This handsome black and white interior is one of four trim selections. Whichever you choose you can be sure of smart styling. You can count on big 6-passenger roominess and comfort too . . . with *all* seats foam-cushioned . . . arm rests and ash trays front and rear. Count also on typical Falcon wagon finishing touches like the color-keyed rubber mat that protects the entire cargo floor.

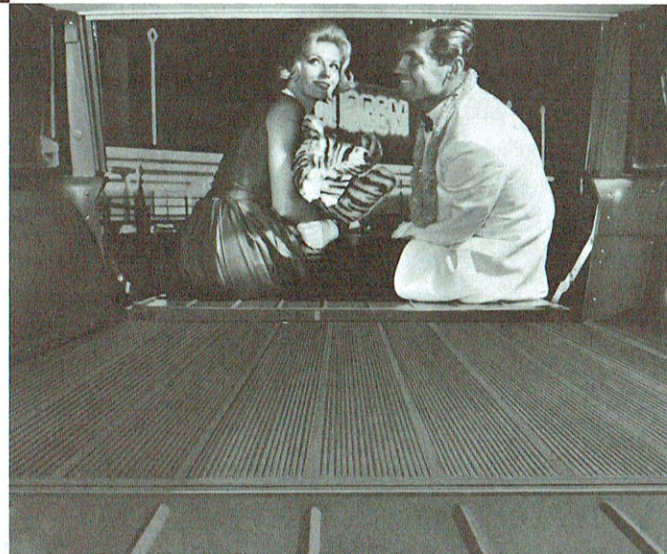

FALCON FORDOR WAGON in Fieldstone Tan with Deluxe trim (Offered also in Deluxe Tudor and standard Tudor and Fordor models)

**FORDOR WAGON.** Falcon is America's best selling compact wagon because it offers all the best features of the best of the big wagons (which are Fords, too, naturally!) \ Outside, there's smart wagon styling, the kind that has made Ford America's wagon specialists. Inside, big 6-passenger spaciousness, the kind that has made Falcon famous. Convenience is everywhere: quick-converting second seat . . . roll-down tailgate window . . . counterbalanced tailgate . . . easy-to-reach spare . . . and big, big 76.2 cu. ft. cargo space! \ Adding durability and savings, Falcon mufflers (on wagons and sedans) are *fully* aluminized to last up to *three* times as long as mufflers on '56-'59 model Fords and other cars!



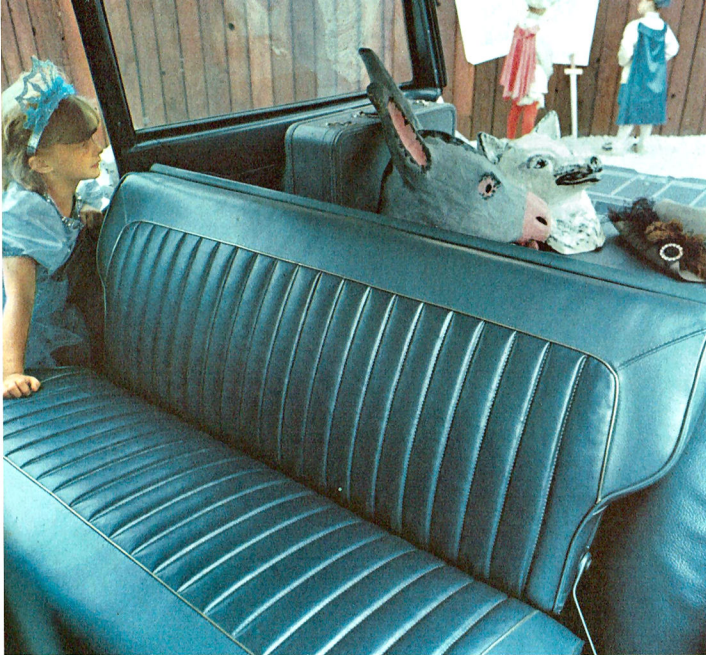

### FALCON SQUIRE STANDARD EQUIPMENT

Includes most Standard Equipment and Deluxe trim items referred to and listed on page 12, plus . . .

Distinguished Compact Wagon Styling: Limed Oak Glass Fiber Rails Enclosing Walnut-Grained Panels on Body Sides and Rear  
 \ Power Tailgate Window, Operated from Instrument Panel or Tailgate  
 \ Color-Keyed Wall-to-Wall Carpeting (passenger area)  
 \ Choice of Three Pleated All-Vinyl Interiors, One Woven Plastic and Vinyl Interior. (For Options and Accessories, see page 16.)

**Counterbalanced Tailgate.** Thanks to thoughtful Ford engineering, Falcon's tailgate flips open and shut so easily even a child can do it. Concealed assist springs do all the hard work. Power tailgate window is another thoughtful convenience. So easy to regulate for just the desired amount of straight-through ventilation. For safety, window must be completely lowered *before* tailgate can be opened.

**Falcon Squire Interior.** Depend on Falcon to be first with compact wagon luxury like this. Pleated all-vinyl seat trim in two-tone metallic blue illustrates one of four offerings. All of them, in addition to their smart good looks, are ruggedly durable and simplicity itself to keep clean. This view also clearly indicates that Falcon Squire is a *working* wagon, with plenty of hauling space even with the second seat set for passengers. With second seat converted, the Squire boasts big, flat and level cargo space of 76.2 cubic feet.



FALCON SQUIRE in Corinthian White

**FALCON SQUIRE.** The "Thunderbird of wagons," Ford's famous, full-sized Country Squire has given much of its distinction and luxury as well as part of its name to this Falcon wagon. \ The Squire has the custom-crafted look of classic wagon styling. For this Falcon's rich woodlike trim, like its Diamond Lustre Enamel, *never* needs waxing. Just wash and remove any corrosive substances with a good grade of polish. \ As you'd imagine, many features listed "extra" on other compacts are *standard* on Falcon Squire. Bright-metal window frames, wall-to-wall carpet, power tailgate window . . . to name but three. The price is *low* as only a Falcon can be—right down among the *lowest!*





## Falcon Options and Accessories

**LIFEGUARD DESIGN.** '62 Falcons give you these Lifeguard Design features as standard equipment: safety-padded arm rests, deep-dish 3-spoke steering wheel, and double-grip door locks. Ford Lifeguard Design options available at slight extra cost include: *Lifeguard Jr. rear door safety locks* to prevent tiny hands from inadvertently opening rear doors. *Color-keyed foam-padded dash and white padded visors* enhance interior beauty as they add to your safety. *Safety seat belts* can be installed quickly with Falcon's built-in standard equipment anchors.

**ELECTRIC WIPERS** (2-speed). Separate options that Falcon owners often purchase together are 2-speed electric wipers and **WINDSHIELD WASHER.** Washer operates simply, responds instantly. Floor-mounted pedal regulates flow of twin water jets, automatically turns on wipers to wash away road spatter and grime. (Wipers, washer not interconnected on Station Bus, Club Wagons.)

**POLARAIRE CONDITIONER.** Big capacity (enough to cool a 4-room house) and fast cool-down give cool, cool comfort on summer's hottest days. And you'll find that PolarAire can be quickly installed in your Falcon at mighty comfortable cost.

**FALCON FORDOMATIC.** Falcon owners praise Falcon's proved automatic transmission for its happy blend of gas economy, 2-speed smoothness and good pickup. This option makes driving America's easiest handling compact almost effortless.

**FRESH AIR HEATER.** How Falcon owners favor *this* option! Welcome quick warm-up for those frosty mornings. Powerful 2-speed blower gives balanced heat distribution to both front *and* rear seats, as well as clear windshield defrosting.

**RADIOS.** (Push button model on sedans and wagons; manual model on Station Bus and Club Wagons.) Outstanding tone quality and power—reasonably priced. Transistor-powered for compactness, dependability, longer life. Adds greatly to your driving pleasure now, adds more to your car's value at trade-in time.

**WAGON TOP LUGGAGE RACK.** Falcon wagon owners love this option for its handsome, stylish appearance, and because it increases load capacity as much as 57%! Attaches permanently to the roof. Chrome-plated and stainless steel construction to withstand the weather and stay bright and good looking with little care.

**ADDITIONAL OPTIONS.** 170 Special Six Engine (standard on Deluxe Club Wagon) \ 17 Two-Tone Paint Combinations \ 54-Plate 55 Amp-Hr Battery \ Rayon Cord Tires; Sedans—6.00 x 13 2-ply white sidewall, 6.50 x 13 2-ply black or white sidewall; Wagons—6.50 x 13 2-ply white sidewall, or 6-ply black or white sidewall \ Wheel Trim Rings \ License Plate Frames \ Backup Lights \ Power Tailgate Window (standard on Squire) \ Deluxe, Solid Wheel Covers \ Spotlight \ Locking Gas Cap \ Body-Mounted Full-View Mirrors \ Inside Non-Glare Mirror \ I-Rest Tinted Glass \ Seat Covers, and many others.

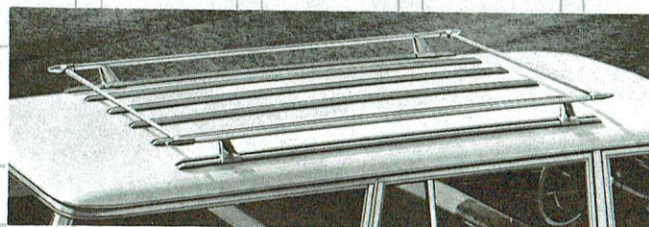
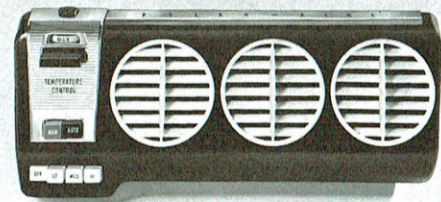

## Upholsteries and Colors

Coded color guide below illustrates the 16 Falcon exteriors in Diamond Lustre Enamel—the finish that needs only a wash and a polish to glisten like new. It *never* needs waxing! By simple cross reference you can quickly tell the colors and interior trim choices available with your favorite new Falcon. **EXAMPLE:** A Falcon Futura with medium blue vinyl interior comes in M (Corinthian White), F (Baffin Blue), E (Viking Blue), and H (Oxford Blue).

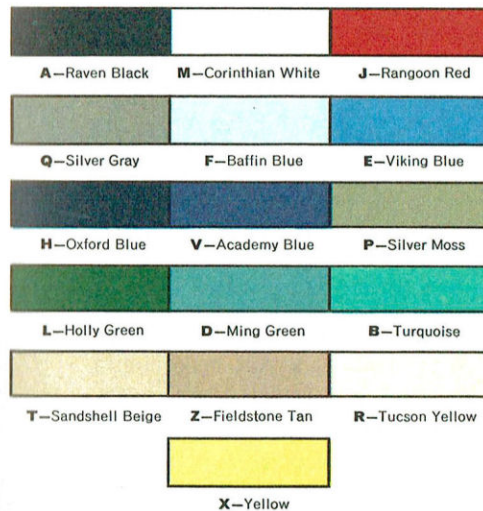

### EXTERIOR COLOR CHOICES

### STD. SEDAN

### DELUXE SEDAN

### FUTURA

### STD. WAGON

### DELUXE WAGON & SQUIRE

### BUS & CLUB WAGON

Deluxe Club Wagon—E  
All Others—M · F · E · H

Std. Sedan—A · M · J · Q · F · E  
H · P · D · T · Z  
Deluxe Sedan—A · M · J · Q · R  
Futura—A · M · J · Q · P · R  
Station Bus—A · M · J · F · V · L  
· B · T · X  
Other Wagons—Same as Std. Sedans, plus R

Deluxe Sedan—M · T · Z · R  
Futura—M · P · T · Z · R  
Club Wagon—A · M · J · F · V  
· L · B · T · X  
Other Wagons—A · M · J · Q · F  
· E · H · P · D · T  
· Z · R

Deluxe Sedan (1)—M · P  
All Others—M · D

All Models—A · M · J · Q

**TWO TONE COMBINATIONS.** There are 17 Diamond Lustre two-tone combinations available for '62 Falcons. (The Squire comes only in solid colors. The Deluxe Club Wagon is available only in solid Viking Blue and two-tone Corinthian White and Viking Blue. Two-tone Bus color scheme is dark-light-dark.)

Using the color guide below, you can determine Falcon two-tone combinations. In each, the first letter represents the top color, the second the bottom color. **EXAMPLE:** "M/A" is Corinthian White upper, Raven Black lower. In most cases the lower body color determines interior trim choices. For the exceptions, consult your Ford Dealer.

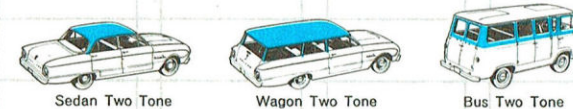

M/A	M/J	M/Q	M/F	M/E	M/H	M/V	F/E	M/P
M/L	M/D	M/B	M/T	M/Z	T/Z	M/R	M/X	

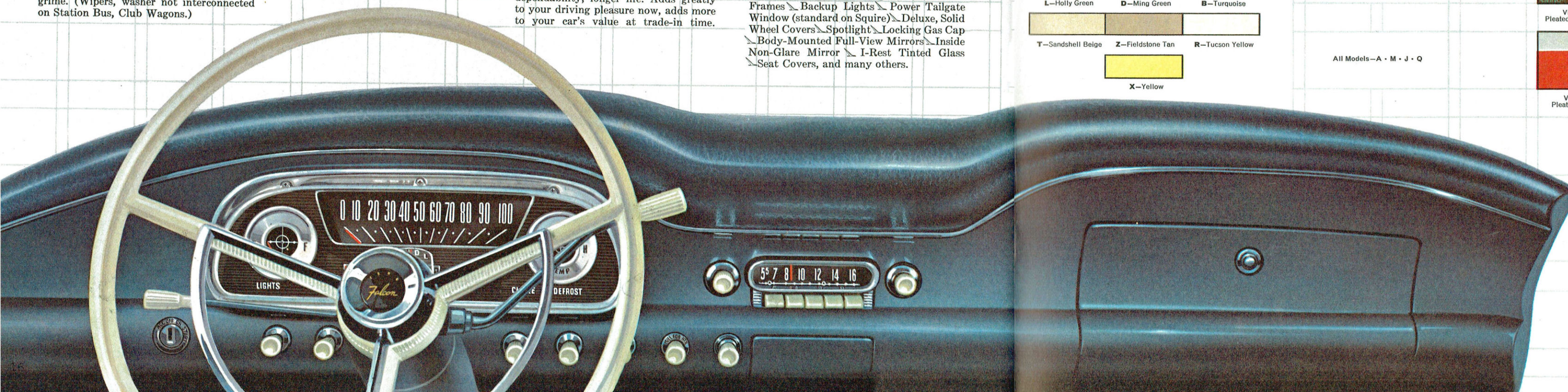

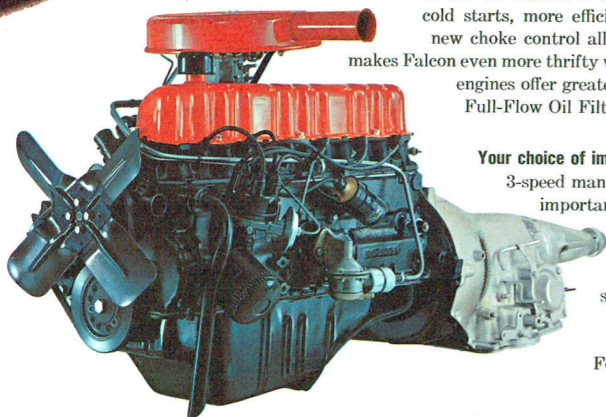
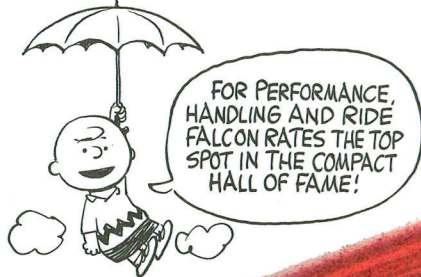

Best shape economy's ever been in—a Falcon engine! Choose either the 85-hp Falcon Six, or optional 101-hp 170 Special Six (standard on Deluxe Club Wagon)

## Under Falcon's Hood

**Your choice of improved engines.** Whether you go all out for gas savings and select the standard Falcon 144 Six or prefer an extra helping of power with Falcon's 170 Special Six option, you'll get new thrift and all-around engine economy in the '62 Falcon. A brand-new carburetor provides quicker cold starts, more efficient warm-up and smoother idling. A new choke control allows more precise adjustment. All this makes Falcon even more thrifty with each gallon of regular. Falcon engines offer greater oil savings, too. The super-screening Full-Flow Oil Filter (standard) helps you go 6,000 miles between oil changes!

**Your choice of improved transmissions.** Falcon's standard 3-speed manual and optional Fordomatic also have important refinements for '62 that add to their efficiency and performance. In the manual transmission a new clutch interlock prevents gear clash when shifting from Neutral to Low or Reverse . . . lengthens operating life. A new vacuum-controlled throttle valve with Fordomatic provides greater smoothness while eliminating need for periodic linkage adjustment.

32.6  
USAC

**The '61 Mobilgas Economy Run** started in Los Angeles, finished in Chicago and included 2,500 long, grueling miles in between. The course provided a good cross section of the roads and highways of America. Every American compact was entered. Drivers were skilled experts who "misered out" gas as if they were paying for it. And Falcon won this cross-country test 1-2! The No. 1 Falcon posted a record-breaking 32.6 mpg . . . highest for any "6" or "8" in the 25-year history of the Run! The No. 2 Falcon was close behind with 31.6 mpg. Both came from the factory as you might have ordered them with standard Falcon 144 Six engines and manual 3-speed transmissions. Once again the record is there for all to see—Falcon means top MPG in the U.S.A.!

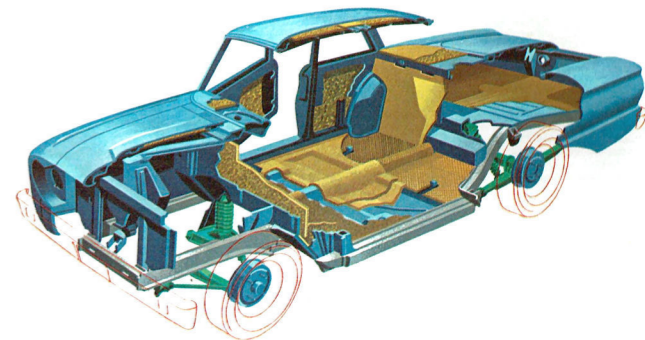

**Single-unit Construction.** Falcon's rock-solid, single-unit construction eliminates bulk, provides greater strength with least weight. This design efficiency also increases interior room for passengers and it greatly reduces squeak and rattle sources. *Body insulation* of many materials surrounds the passenger compartment with a sound-absorbing, noise-damping barrier. *Zinc-plated underbody members*—rocker panels and all vital underbody parts are galvanized for protection against rust and corrosion.

**Big Brakes.** Falcon brakes require so little pedal effort to produce sure, smooth, straight-line stops that you'll forget all about big-car power assists. Falcon brakes are "sized" to the braking job, too. Falcon wagons, being heavier vehicles, have bigger brakes (157 sq. in.) than Falcon sedans (131 sq. in.).

**Big-Car Ride.** Falcon's Ball-Joint front suspension smooths bumps and road faults, greatly reduces "nose-dive" in quick stops. Makes handling surer, safer. Variable-Rate rear suspension has 50-inch leaf springs mounted to the axle off-center, to resist rear end "squat" in starting. Teamed up, they make Falcon wonderfully able, stable and roadwise.

# SPECIFICATIONS

## Sedan and Wagon Dimensions



The Ford Quality Control system, a Ford first, results in products of highest quality. All manufactured parts pass rigid dimensional, laboratory and durability tests. Quality Control teams also select samples from each shift of every assembly plant for an exhaustive search for any deviations from strict engineering specifications.

**FALCON DESIGN:** Welded, integral body and frame for quietness and high strength-weight ratio. Completely sealed and insulated. Roof cross brace at center on sedans and three roof cross braces on wagons give extra rigidity. Zinc-coated rocker panels and main underbody members for durability. Cowlflop ventilation. Wide Angle windshield with forward-slanting pillars. Large, wide-opening doors, with assist-type door checks and bronze-bushed hinges. Double-Grip door locks. Rear-mounted 14-gal. gas tank with Center-Fill fueling on sedans, left rear fender fuel fill on wagons, Station Bus and Club Wagons.

**ENGINES: 85-hp Falcon Six**—144-cu. in. displ.; 3.50" bore x 2.50" stroke; 8.7 to 1 comp. ratio; regular fuel; new low-silhouette unit-design carburetor; manual choke; oil capacity, with filter change, 4.5 qt.

**101-hp Falcon 170 Special Six**—170-cu. in. displ.; 3.50" bore x 2.94" stroke; 8.7 to 1 comp. ratio; regular fuel; new low-silhouette unit-design carburetor; manual choke; oil capacity, with filter change, 4.5 qt.

**FEATURES:** For economy and long life, Falcon engines have short-stroke, low-friction design. Wedge-type combustion chambers; Free-Turning overhead intake and exhaust valves; 3-ring aluminum-alloy pistons with full-chromed top ring; integral cylinder head and 6-port intake manifold; precision-molded crankshaft with four precision-type main bearings; rotor-type pump; Super-Filter air cleaner with reusable element; 30,000-mile high-capacity in-line fuel filtering system; vacuum-boosted type fuel pump for more constant windshield-wiper action; full-pressure lubrication system with Rotunda Full-Flow disposable-type oil filter; pressurized cooling system with 180° Positive-Action thermostat; 30,000-mile or 2-year permanent antifreeze; 12-volt electrical system; weatherproof ignition; 18-mm. Turbo-Action spark plugs; 54-plate, 40 amp-hr battery, positive engagement starter; fully aluminum motor. Engines are electronically mass-balanced while operating under their own power for optimum smoothness.

**CLUTCH AND MANUAL TRANSMISSION:** Single cushion disc, dry-plate clutch for smooth engagement; aluminum housing; permanently lubricated ball-bearing type throw-out bearing. Flare diameter is 8 1/2 in. Total frictional area is 68.1 sq. in. 3-Speed Transmission has new clutch interlock to prevent gear clutch when shifting from Neutral to Low or Reverse; shot-peened fine-pitch helical gears for high strength and quietness with forged bronze synchronizers for smooth operation. Anti-friction bearings throughout. Standard "11" shift pattern with lever on steering column. Ratios (to 1): 1st 3.29, 2nd 1.75 (1.83 with 170 Special Six), direct 1.00, reverse 4.46.

**FORDOMATIC DRIVE** (optional on sedans and wagons): Features simplified design, lightweight cast-aluminum construction, new vacuum-controlled throttle valve for smoothness, minimum servicing. Torque converter in combination with computer-alternatory gear gear set. Two forward gear ratios, one reverse (to 1); low 1.75, direct 1.00, reverse

1.50; converter (stall) 2.4. In "D" range gives brisk, smooth starts in low. Effective engine braking in "L" position. Air cooled with 144 Six, air and liquid cooled with 170 Special Six. Selector lever and quadrant on steering column, sequence P-R-N-D-L.

**REAR AXLE:** Semi-floating type with offset hypoid gears. Induction-hardened forged shafts with permanently lubricated wheel bearings. **Axle Ratios (to 1): Conventional Drive**—Sedans: 3.10 with std. Six, 3.20 with Special Six (2.50 opt. either engine)—All Wagons and Bus: 3.50 with both engines; 4.00 opt. with std. Six only. **Fordomatic Drive**—Sedans and wagons: 3.50 with both engines; 4.00 opt. with std. Six on wagons.

**FRONT SUSPENSION:** Sedans and wagons—Angle-Poised Ball-Joint type with coil springs pivot-mounted on upper arms. Strut-stabilized lower arms. Threaded, permanently lubricated bushings in upper arms and rubber bushings in lower arms for softer ride. Built-in anti-dive control. Internally mounted hydraulic double-acting shock absorbers with rebound cutoff. Link-type, rubber-bushed ride stabilizer. Tapered roller wheel bearings. (Station Bus and Club Wagons have solid front axle and leaf springs.)

**REAR SUSPENSION:** Sedans and wagons—Longitudinal, semi-elliptic leaf springs with rubber-bushed supports and compression-type shackles, giving variable-rate characteristics for a softer, more leveled ride. Asymmetrical design with rear axle located forward from center of springs for anti-squat control on take-off. Full length liners between leaves—no lubrication required. Diagonally mounted hydraulic double-acting shock absorbers. (Station Bus and Club Wagons have front and rear leaf springs similar to the type described.)

**STEERING:** Magic-Circle low-friction recirculating-ball type steering gear provides easy handling. Anti-friction bearings throughout. Over-all steering ratio—sedans and wagons: 27 to 1; Station Bus and Club Wagons: 20 to 1. Lifeguard 17", black, 3-spoke, deep-center steering wheel. Turning diameter—sedans and wagons: 38.8 ft.; Station Bus and Club Wagons: 34.8 ft.

**BRAKES:** Double sealed, self-energizing hydraulic with composite drums. Diameter, front and rear: 9 in. on sedans and wagons, 10 in. on Station Bus and Club Wagons. Molded linings for long life and fade resistance. Total lining area 131.0 sq. in. on sedans, 157 sq. in. on wagons; 168 sq. in. on Station Bus and Club Wagons.

**TIRES:** Soft-Tread design, black, tubeless with Tyrex Rayon cord. Safety-type rims. Sedans—6.00 x 13 2-ply on 4" rims; Wagons—6.50 x 13 2-ply 4-ply (4-ply for Station Bus, Club Wagon) on 4 1/2" rims; Deluxe Club Wagon—7.00 x 13 6-ply on 4 1/2" rims. Spare wheel and tire location: Sedans—luggage compartment; Wagons, Station Bus and Club Wagons—cargo area behind right-hand wheelhousing.

**CURB WEIGHTS (est.):** Sedans—2370 lb. Tudor, 2405 lb. Fordor; Wagons—2641 lb. Tudor, 2674 lb. Fordor. Station Bus—2740 lb. For dimensions see illustrations at right.

**PRICES:** All Optional Equipment and Accessories, illustrated or referred to as optional or available in this catalog are at extra cost. For the price of the Falcon with the equipment you desire, see your Ford Dealer.

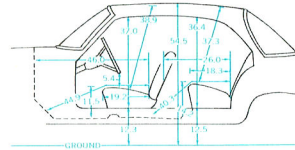

Wheelbase: 109.5"; Treads: 55" front, 54.5" rear

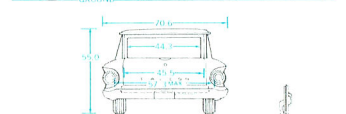
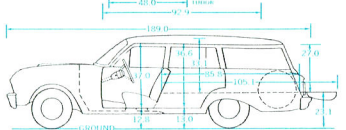
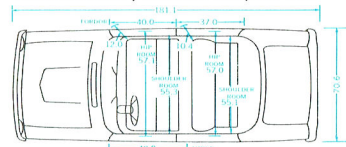

Station Bus and Club Wagon Dimensions

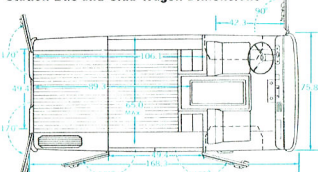

Wheelbase: 90"; Treads: 60" front, 60.2" rear

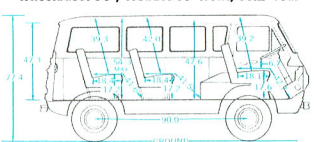

Comparative information in this catalog was obtained from authoritative sources, but is not guaranteed. The specifications contained herein were in effect at the time this catalog was approved for printing. Ford Division of Ford Motor Company reserves the right to discontinue models at any time, or change specifications or design without notice and without incurring obligation.

## PRODUCTS OF MOTOR COMPANY

WHAT FORD NEEDS IS A SLOGAN...ONE THAT SUGGESTS HOW MUCH A FALCON GIVES YOU WHILE SAVING YOU LOTS OF MONEY....

HOW ABOUT, "HOW GREEN WAS MY VALUE"?



## Your Friendly FORD Dealer