



ALL-NEW 2006

FORD LCF





AT YOUR SERVICE

The best-selling line of commercial trucks just got stronger. Introducing the all-new 2006 Ford LCF. Designed specifically for businesses in North America, the Ford LCF is especially well-suited to urban areas where traffic is heavy, street space is at a premium, and corners can be tight. So if your list of must-haves includes visibility, maneuverability, operating ease and overall efficiency – look no further. Ford LCF is the right truck for you. As a bonus, you can order it in your choice of 9 vibrant exterior colors – no extra charge, no extra waiting – now that's service.

Some vehicles shown include optional or aftermarket uplift equipment. Class comparisons are based on Class 4 Tilt-Cab Diesel competitors excluding Ford joint-venture partners.

2006 FORD LCF

DESIGNED & BUILT FOR YOUR MARKET

The all-new 2006 Ford LCF is made **SPECIFICALLY FOR THIS MARKET**. In fact, you'll find it's one of the key advantages this Built Ford Tough truck offers over the competition. Want another? The chassis on the all-new Ford LCF shares many key components with our proven Super Duty models. So you can depend on the Ford LCF the same way you would the Ford Super Duty. And, most importantly, the Ford LCF was

engineered here. It was thoroughly tested and put through its paces here. And it gets assembled just a short distance away, so no overseas shipping is needed after final assembly. All of which adds up to the fact that we can confidently offer you the right vehicle to meet your company's tilt-cab needs. **QUICK TURNAROUND ON SPECIAL ORDERS** is another beneficial feature of the Ford LCF. Unlike

our competitors who build and customize overseas, we won't leave you waiting when you choose any of our 9 regular production exterior colors, 5 available wheelbases, 4 AFs (Axle-to-Frame lengths) or the Interior Upgrade Package. We also cover you with 24-hour turnaround on up-time critical parts, as well as a unique Limited Warranty through our Ford LCF-Certified Truck Dealers.



CONTENTS

CAPABLE	3
POWERFUL	5
MANEUVERABLE	7
EASY TO OPERATE	9
ACCOMMODATING	11
EASY TO UPFIT	13
WRAP-UP	15
SPECIFICATIONS	17
STRONG SUPPORT	21

WWW.COMMTRUCK.FORD.COM

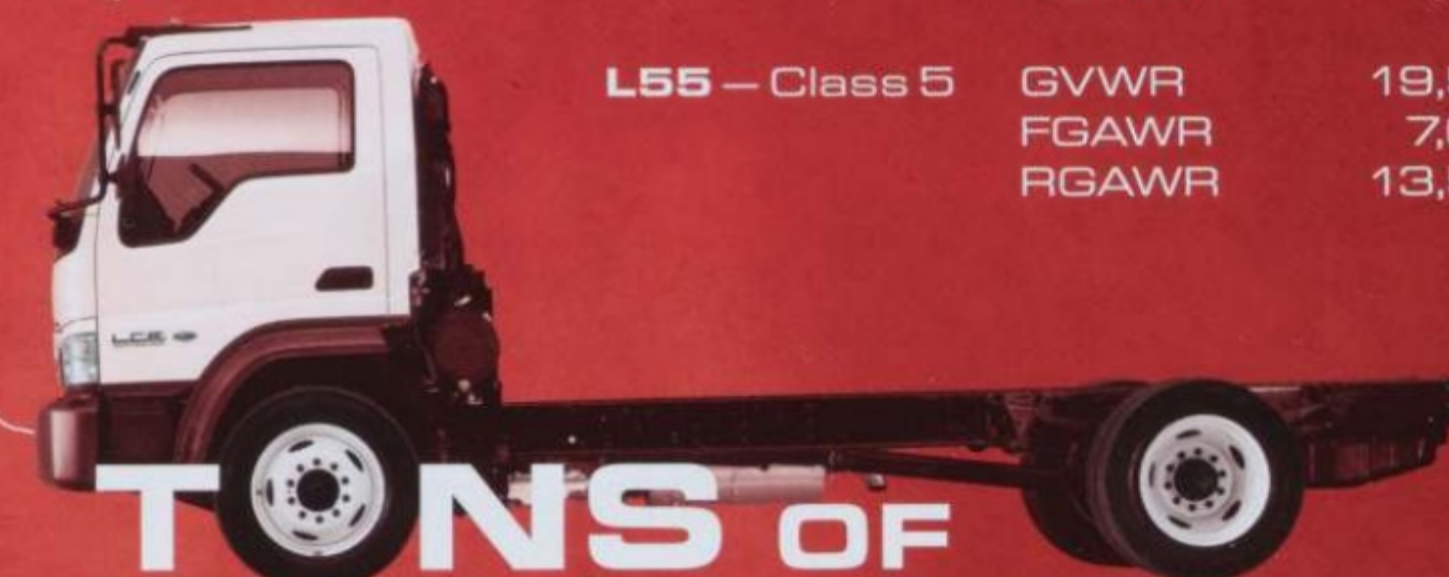

TONS OF CAPABILITY

MODEL LINEUP		STANDARD	OPTIONAL
L45 – Class 4	GVWR	16,000 lbs.	15,000 lbs.
	FGAWR	6,000 lbs.	7,000 lbs.
	RGAWR	11,000 lbs.	–
L55 – Class 5	GVWR	19,500 lbs.	17,999 lbs.
	FGAWR	7,000 lbs.	–
	RGAWR	13,500 lbs.	–

Whether you need to move an actual rhinoceros (don't laugh – it's somebody's business) or just haul a jumbo-sized load, you can count on the all-new Ford LCF to help keep your business running smoothly. With the strongest standard frame in its segment, the Ford LCF features available GVWRs of 15,000, 16,000, 17,999 and 19,500 lbs.

For those doing particularly heavy hauling, the Ford LCF L45 has a rear GAWR of 11,000 lbs., while the L55 gives you a full 13,500-lb. rating in back. That's quite a few rhinos. The Ford LCF also features long, tapered leaf springs for confident ride and handling. The springs give a softer ride when the load is light, and increase in stiffness as the payload increases.



FRAME STRENGTH



With a mighty **461,000 RBM** (Resisting Bending Moment), Ford LCF proudly boasts the **STRONGEST STANDARD FRAME IN ITS SEGMENT**. How do we achieve such a feat? For starters, the frame rails are created from high-strength, low-alloy steel with a 50,000 psi rating. Then, we attach the proven **SINGLE-PIECE FRAME CROSSMEMBERS** securely to the frame rails using **SEGMENT-EXCLUSIVE HUCK BOLTS** for high assembly integrity and longevity.

The result is a Built Ford Tough chassis you can depend on to get the job done. Ford LCF trucks also feature a clean CA (Cab-to-Axle) and standard 34" frame rail width, both of which make for **EASY, COST-EFFICIENT UPFITTING**. And, since the frame rail width is the same as on Ford Super Duty models, their upfitting body options are interchangeable.

4-WHEEL DISC ABS

When your business is on the line and you're dealing with serious payloads, you need a truck that **PERFORMS AT ITS BEST – STOPPING AND GOING**. That's why every Ford LCF features fully hydraulic 4-wheel disc brakes and an Anti-lock Brake System (ABS) as standard equipment. You don't have to settle for the Class 4 competitors that use 16" wheels and a narrower track. Ford LCF features standard 19.5" wheels and a wide track (73.4" front/74.0" rear) to help provide a **STABLE FOUNDATION**.



19.5" WHEELS



CAPABLE

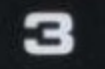

WWW.COMMTRUCK.FORD.COM

CLASS-LEADING BRUTE STRENGTH

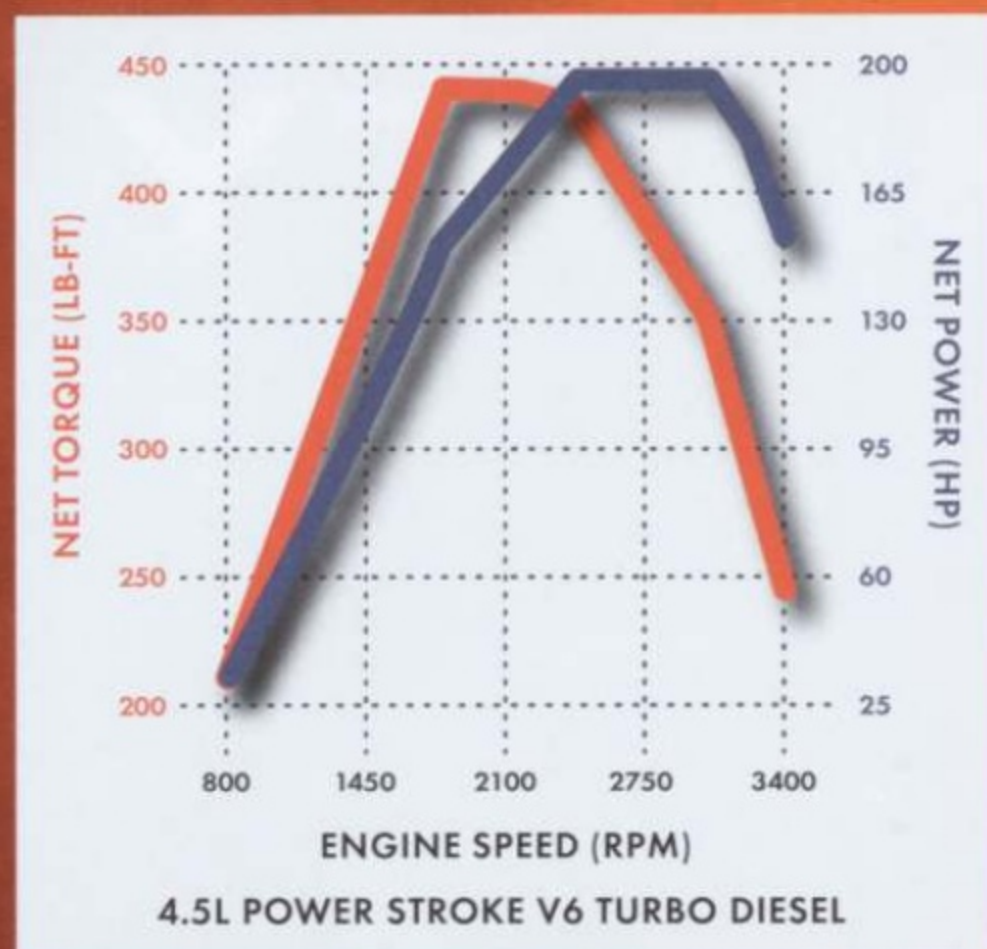

Fire up the all-new 4.5L Power Stroke® V6 Turbo Diesel beast and there're 200 hp and 440 lb.-ft. of torque at your disposal. That's a strong start for any business – best in its class.* Standard on every Ford LCF, this durable engine is combined with our robust TorqShift™ transmission – the same proven 5-speed automatic featured in many other Built Ford Tough trucks – to deliver maximum power, reliability and efficiency.

4.5L POWER STROKE V6 TURBO DIESEL

HORSEPOWER	200 @ 2650
TORQUE (LB.-FT.)	440 @ 1850
COMPRESSION RATIO	18:01

4.5L POWER STROKE V6 TURBO DIESEL



In addition to producing class-leading hp and torque, the 4.5L Power Stroke is built to stand the test of time. After being subjected to **OVER 2 MILLION MILES OF EXTREME TESTING** – from inner-city congestion to desert heat to high elevations – it emerged with a projected B10 life of 250,000 miles. The only V6 available in the segment, it features a **DUAL-TURBO DESIGN** for quick engine response around town and out on the highway. Derived from Ford's renowned

6.0L Power Stroke V8 Turbo Diesel, this engine also helps make the all-new Ford LCF easy to service. For instance, the **OIL AND FUEL FILTERS ARE MOUNTED ON TOP** of the engine [left], so they're readily accessible when it's time to perform routine maintenance. Since these same filters and many major components are interchangeable with its V8 cousin, you'll also benefit from **QUICK PARTS AVAILABILITY**.

*Class 4 Tilt-Cab Diesels, excluding Ford joint-venture partners.

TORQSHIFT TRANSMISSION

Standard on every Ford LCF, the proven TorqShift 5-speed automatic transmission features pure **ELECTRONIC SHIFT CONTROLS** for optimum responsiveness and a torque converter designed for enhanced low-speed capability. Its high-capacity pump design results in increased lubrication and better cooling, while the gearing and precision clutch material help enhance overall durability. For ease of serviceability, the spin-on transmission oil filter is externally mounted. **TOW/HAUL MODE** should be selected when hauling a heavy load or trailer. It helps reduce gear hunting, improves power delivery, and even uses engine braking to help control vehicle speed when descending hills. The available transmission-integrated **PTO (POWER TAKEOFF)** provision [Order Code 44B] is essential for powering accessories like liftgates, skylifts, auxiliary hydraulic pumps and other add-on equipment.





MANEUVERABLE

7

NAVIGATE TIGHT SPACES

You can't go wrong with the best-in-class maneuverability of the all-new Ford LCF. It's built to take your business everywhere you want it to go, thanks to the segment's tightest turning radius.* You'll find the 53° wheel cut helps make the Ford LCF easy to maneuver – even when our standard wheel-base is longer than the leading competitor's.

WHEELBASE	CURB-TO-CURB	WALL-TO-WALL
113"	16'5"	18'4"
137"	19'3"	21'0"
149"	20'8"	22'5"
167"	22'5"	24'2"
185"	24'6"	26'3"

TURNING RADIUS

BEST-IN-CLASS MANEUVERABILITY

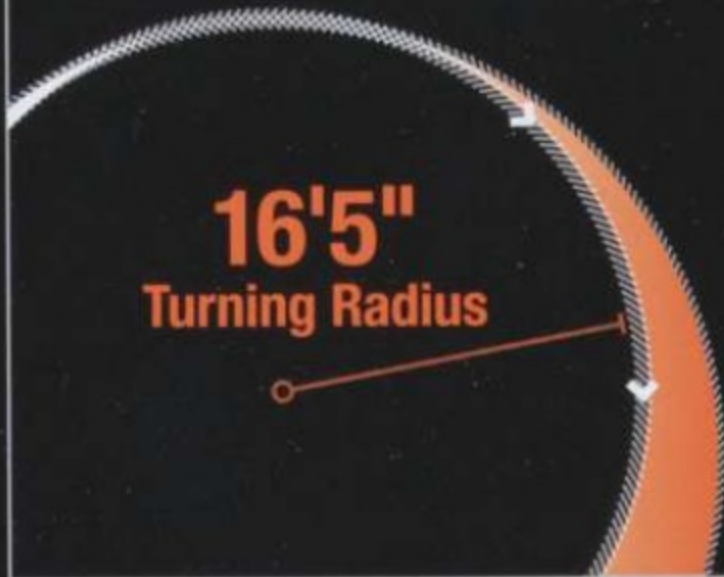

You'll really appreciate the ease with which you can navigate the all-new Ford LCF up to loading docks and around crowded job sites. And it's all thanks to the superb maneuverability provided by the segment's **TIGHTEST CURB-TO-CURB AND WALL-TO-WALL TURNING RADIUS.**

The Ford LCF also features a remarkably **SHORT 73.2" BUMPER-TO-BACK-OF-CAB (BBC)** measurement. That's the beauty of the tilt-cab design. Since the full length of the cab sits directly above the engine, the front end takes up much less real estate than a traditional chassis cab – which can lead to shorter overall lengths as well. So the Ford LCF turns tight corners and fits into small spaces with ease.

Maneuverability is of the utmost importance, but it should always be accompanied with the peace of mind that comes from a secure payload. The all-new Ford LCF delivers serious stability and capability via the tried-and-true design of its rugged **I-BEAM-TYPE FRONT AXLE.** You have a choice of a **6000-LB. STANDARD FRONT-AXLE CAPACITY ON L45** or a **7000-LB. STANDARD CAPACITY ON L55** (also available on L45). Both models include **LONG, TAPERED LEAF SPRINGS** and standard shocks in the front and rear to provide a softer ride when your payload is light and automatically stiffen to help manage heavier payloads. Standard **AEON AUXILIARY SPRINGS** provide additional stiffness in the back – essential when you're hauling particularly heavy loads.

SOLID UNDERPINNINGS

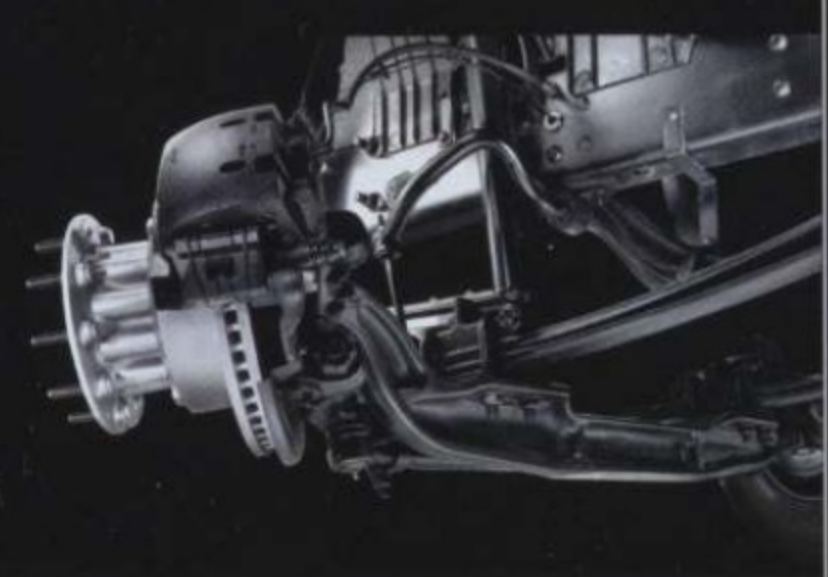

WWW.COMMTRUCK.FORD.COM



EASY TO OPERATE

FORD LCF WITH INTERIOR UPGRADE PACKAGE AND OTHER AVAILABLE EQUIPMENT

10

EASY ON THE EYES

The efficient tilt-cab design of the all-new Ford LCF offers a level of driver visibility you might not have believed could exist – before now. Without a hood to look over, the Ford LCF offers

an extraordinary panoramic view. Plus, large, cab-mounted mirrors help enhance the side and rear views. So you can see up, down, pretty much all around, without straining a muscle.

The Ford LCF includes many standard features to help your days run smoother. In addition to the thoughtful design and location of its controls, there's an **OVERHEAD STORAGE AREA WITH 2 STORAGE BINS**, **3 GLOVE COMPARTMENTS** in the instrument panel, and a **MAP POCKET** in each door. We even included **2 CUPHOLDERS** that store out of the way (in the instrument panel) when not in use.

We realize that not all drivers are built alike. So the Ford LCF features a standard **TILT/TELESCOPING STEERING COLUMN** that allows you to make the necessary adjustments to achieve your preferred driving position and maximize your comfort.

DRIVER CONVENIENCE



WWW.COMMTRUCK.FORD.COM

WITH ROOM FOR A CREW

Whether you need room for the occasional passenger in your service or vehicle-recovery business, or need to make the most of each morning's run to the job site, the all-new Ford LCF is built to accommodate. Ample 3-passenger seating comes in durable standard vinyl or available cloth trim (shown). There's more than enough head and leg room to satisfy big and tall riders alike. Plus, the well-positioned grab handles and a first step that's low to the ground make entry and exit a breeze.

STANDARD FOLDING SEATS



A supportive **HIGH-BACK TILT DRIVER'S SEAT** with integral head restraint and roomy **2-PERSON PASSENGER SEAT** with high-back outboard passenger's seat and integral head restraint are standard on every Ford LCF. Each passenger seatback folds down to reveal a handy **NOTEBOOK TRAY**, perfect for use as a work surface. (Available cloth seats shown.)

INTERIOR UPGRADE PACKAGE

Driver comfort is high on your list of priorities – as it should be. And with the all-new Ford LCF, it's easy to make your workdays a little more enjoyable. Just order the available Interior Upgrade Package [Order Code 60A]. It includes comfortable **CLOTH SEATING** in Flint Grey, **AIR CONDITIONING** with an integral heater and defroster, **POWER DOOR LOCKS** and **POWER WINDOWS** with a driver's-side one-touch-down feature, plus a **REMOTE KEYLESS-ENTRY SYSTEM** with panic alarm and audible lock confirmation. You'll be feeling more satisfied than ever.



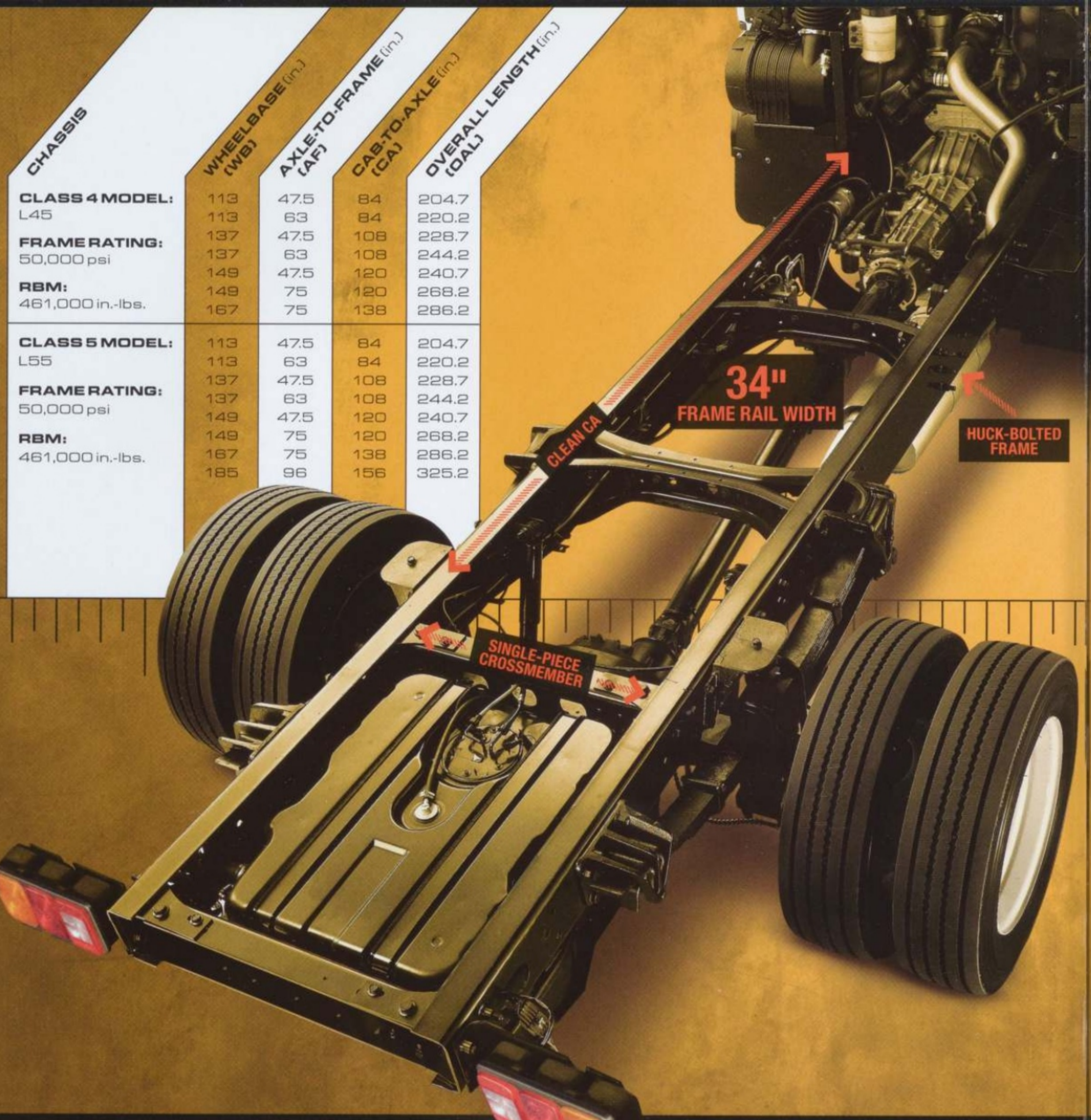

CHASSIS	WHEELBASE (WB) (in.)	AXLE-TO-FRAME (AF) (in.)	CAB-TO-AXLE (CA) (in.)	OVERALL LENGTH (OAL) (in.)
CLASS 4 MODEL:	113	47.5	84	204.7
L45	113	63	84	220.2
FRAME RATING:	137	47.5	108	228.7
50,000 psi	137	63	108	244.2
RBM:	149	47.5	120	240.7
461,000 in.-lbs.	149	75	120	268.2
	167	75	138	286.2
CLASS 5 MODEL:	113	47.5	84	204.7
L55	113	63	84	220.2
FRAME RATING:	137	47.5	108	228.7
50,000 psi	137	63	108	244.2
RBM:	149	47.5	120	240.7
461,000 in.-lbs.	149	75	120	268.2
	167	75	138	286.2
	185	96	156	325.2

SOME ASSEMBLY REQUIRED

These words may strike fear in the hearts of some, but here they represent your opportunity to build the all-new Ford LCF that fits your business best by choosing from a vast array of compatible upfit bodies and equipment. We offer up to 5 different clean CA measurements on LCF to make upfitting easy. And while some competitors' measurements imply that you have more space than you can use, our numbers represent a truly clean, usable part of the frame.

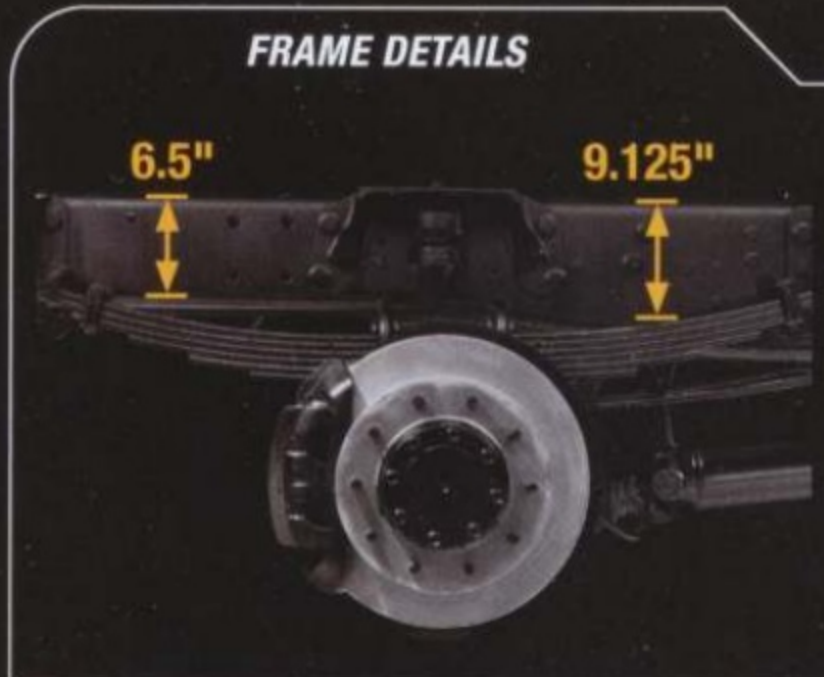

FRAME DETAILS

Thanks to the low 30" ground-to-top-of-frame height of its standard **KICKUP FRAME**, the Ford LCF is ideally suited to pickup and delivery applications that require a low and flat loadfloor without any interior encroachment. Every Ford LCF also features a standard **34" FRAME RAIL WIDTH** to help facilitate upfits. There are several **FUEL TANK OPTIONS** available, including the standard **40-GALLON TANK** mounted between the frame rails and aft-of-axle for balanced weight distribution. An available **35-GALLON TANK** is mounted outside the frame rails on the left. If your upfit dictates, or you need maximum fuel range, opt for a set of **TWO 35-GALLON TANKS** mounted outside the frame rails, one on each side of the vehicle. To help contain maintenance costs, the Ford LCF also features **2 MAINTENANCE-FREE BATTERIES** conveniently mounted in a box outside the frame rails on the right.

With its natural agility and package efficiency, the all-new Ford LCF is ideal for use in urban areas. Its powerful 4.5L Turbo Diesel, proven TorqShift™ transmission, GAWR choices, wheel-base options, **CLEAN CA CHOICES**, range of **AF OPTIONS** and **FUEL TANK CHOICES** all add up to the kind of customizing your business demands. You have the power to create the Ford LCF you need. This recovery upfit, for example, utilizes the **PTO PROVISION** to help power its carrier bed.



ENDLESS UPFITTING POSSIBILITIES

CLASS 4 & 5 OFFERINGS

L45 (Class 4)

- Standard: 16,000-lb. GVWR
6000-lb. front GAWR
11,000-lb. rear GAWR
- Optional: 15,000-lb. GVWR
7000-lb. front GAWR

L55 (Class 5)

- Standard: 19,500-lb. GVWR
7000-lb. front GAWR
13,500-lb. rear GAWR
- Optional: 17,999-lb. GVWR

DESIGNED & BUILT FOR YOUR MARKET

One of the major differences between the new Ford LCF and its competition: this Built Ford Tough truck is designed and built specifically for this market. It's built a short distance away, and no overseas shipping is needed after final assembly. So not only are we confident the Ford LCF will meet your company's tilt-cab needs, we're also able to offer **QUICK AND FLEXIBLE ORDERING.***

*Minimum order requirements may apply.

CAB-MOUNTED MIRRORS

Ford LCF's large sideview mirrors provide the **CLEAR REAR VISIBILITY** you need to see what you're up against. Mounting them to the cab rather than the door helps avoid vibration and ensure a clear view.

PTO – POWER TAKEOFF PROVISION

An available transmission-integrated PTO provision can help your new Ford LCF **SUPPLY POWER** for essential on-the-job accessories like liftgates, winches, pumps and other add-ons.

9 NO-CHARGE COLORS

We offer the Ford LCF in your choice of 9 different exterior colors at no extra charge – with no extra waiting. So you can **MAKE THE MOST OF YOUR INVESTMENT** by coordinating your new Ford LCF with your company identity.

19.5" WHEELS & TIRES/ 4-WHEEL DISC ABS

A wide track and standard 19.5" wheels and tires help provide a **STABLE FOUNDATION** for the Ford LCF while some Class 4 competitors use a narrower track and 16" wheels. A fully hydraulic 4-wheel disc **ANTI-LOCK BRAKE SYSTEM (ABS)** is also standard on the Ford LCF.

STRONGEST STANDARD FRAME/ 34" FRAME RAIL WIDTH

The all-new Ford LCF boasts the strongest standard frame in its segment** with a mighty **461,000 RBM**. The frame also features our standard 34" frame rail width for **EASY, COST-EFFICIENT UPFITTING**.



OVER 2 MILLION MILES OF TESTING

We subjected LCF's all-new 4.5L Power Stroke® Turbo Diesel V6 engine to over 2 million miles of extreme testing, including actual city driving in everything from desert heat to high altitudes – and it met the challenge. In fact, the 4.5L is so durable, it has a projected **B10 LIFE OF 250,000 MILES**.

FORD TRUCK PARTS COMMONALITY

You can trust the Ford LCF to deliver excellent **LONG-TERM DURABILITY PLUS PARTS AND SERVICE AVAILABILITY**, thanks to the fact that its Built Ford Tough chassis shares many key components with our proven Super Duty models.

BEST-IN-CLASS MANEUVERABILITY

You'll find the Ford LCF easy to maneuver – even when our standard wheelbase is longer than the leading competitor's** – thanks to the **SEGMENT'S TIGHTEST TURNING RADIUS** (Curb-to-Curb and Wall-to-Wall) and a **53° WHEEL CUT**.

BEST-IN-CLASS POWER & TORQUE

The standard 4.5L Power Stroke Turbo Diesel V6 engine in Ford LCF delivers a full **200 HP @ 2650 rpm** and **440 LB.-FT. OF TORQUE @ 1850 rpm**, placing it firmly at the top of Class 4.**

**Class 4 Tilt-Cab Diesels, excluding Ford joint-venture partners.



LET'S TALK VISUAL IMPACT

What line of work are you in? So are we. Whether your business is pickup and delivery, recovery, landscaping, or one of the many others that demand the capability of the all-new Ford LCF, we know you've worked hard to establish your company's good reputation and corporate identity. So we offer LCF in 9 different no-charge exterior colors. No need for special orders. You'll find it's easy to coordinate LCF with the rest of your marketing efforts – and achieve maximum visual impact in your community.



SPECIFICATIONS

INTERIOR UPGRADE



FLINT GREY VINYL is the standard seating surface on both LCF models. **FLINT GREY CLOTH** [left] is available on both models as part of the Interior Upgrade Package. The **INTERIOR UPGRADE PACKAGE** also includes • air conditioning with integral heater/defroster • power door locks • power windows with driver's-side one-touch-down feature • remote keyless-entry system with panic alarm and audible lock confirmation.

19.5" WHEELS & TIRES



19.5" x 6" hub-piloted, 10-lug **PAINTED-WHITE STEEL WHEELS** [A] and 225/70R19.5 Goodyear G647 tires* (load-range F) are standard on both LCF models. 19.5" x 6" hub-piloted, 10-lug **POLISHED-ALUMINUM WHEELS** [B] and 225/70R19.5 Michelin XZE tires are also available on both LCF models.

*Late availability.

STANDARD EQUIPMENT

MECHANICAL

- Air cleaner – Single-element with Filter Minder® indicator
- Alternator – 12-volt, 135-amp
- Batteries – Dual, Motorcraft® 12-volt, 1800 CCA
- Brakes – Front/rear disc, hydraulic split system with 3-channel Anti-lock Brake System (ABS)
- Emissions – 50-state-certified
- Engine – 4.5L Power Stroke® V6 Turbo Diesel
- Shock absorbers – Front and rear
- Speed control
- Springs – Auxiliary rear, Aeon rubber, 1500-lb. rating
- Stabilizer bars – Front and rear
- Transmission – TorqShift™ 5-speed automatic with Tow/Haul Mode

EXTERIOR

- Bumper – Front, Argent molded-in-color
- Cab steps – Integrated into wheel lip
- Clearance lamps – 5 roof-mounted
- Doors – With drop window and black handle
- Grille – Dark Shadow Grey
- Headlamps – Jeweled-appearance
- License plate surround – Molded into front bumper fascia
- Mirrors – Sideview dual 6" x 11" rectangular and 8" x 6" convex rectangular with breakaway-type brackets, 96"-wide spacing
- Tinted glass
- Tow hooks – 2 front
- Wipers – Fixed and interval settings with wet-arm fluid delivery

INTERIOR

- Cupholders – 2 integrated into instrument panel
- Dome light – Door-operated or manual switch
- Door trim – With map pockets (1 per door)
- Floor covering – Vinyl
- Grab handles – 2 A-pillar-mounted
- Headliner – Color-coordinated cloth
- Heater – With defroster and 4-speed blower motor
- Horn – Electric
- Instrument panel – Color-coordinated with 3 glove compartments, 2 storage bins, air registers, left-hand and center ashtrays, and cigar lighter
- Instrumentation – Tachometer, trip odometer, fuel gauge, coolant temperature gauge and indicator lights
- Mirror – Rearview
- Overhead storage – Full-length open-bin
- Power point – Right-side, located below instrument panel
- Safety belts – 3-point (driver and outboard-passenger), lap belt (center)
- Scuff plates – Color-coordinated with interior trim
- Seat – Driver's tilt, high-back vinyl with integral head restraint
- Seat – 2-person passenger's high-back vinyl with integral outboard head restraint, center seatback without head restraint, and folding seatbacks with notebook tray
- Steering column – Tilting and telescoping
- Steering wheel – 16"-diameter
- Sun visors – Vinyl with driver's-side strap
- Transmission shift control – Floor-mounted with button for Tow/Haul Mode

FEATURES AND OPTIONS

L45

L55

MECHANICAL

- — Axle, front – Dana Spicer® 6000-lb. I-Beam-type
- ● Axle, front – Dana Spicer 7000-lb. I-Beam-type*
- — Axle, rear – Dana Spicer 11,000-lb. single-reduction
- ● Axle, rear – Dana Spicer 13,500-lb. single-reduction**
- ○ Engine block heater
- ● Fuel tank – 40-gallon capacity steel, mounted between frame rails, aft-of-rear axle
- ○ Fuel tank – 35-gallon capacity steel, rectangular, mounted to left side of frame†
- ○ Fuel tank – Dual 35-gallon capacity steel (70-gallon total capacity), rectangular, mounted to left and right sides of frame†
- — GVWR – 16,000-lb.
- — GVWR – 15,000-lb.
- ● GVWR – 19,500-lb.
- ○ GVWR – 17,999-lb.
- ○ PTO (Power TakeOff) provision – Opening on left side of transmission
- ○ Spare – Matching wheel and tire††
- — Springs, front – 6000-lb. tapered leaf
- ● Springs, front – 7000-lb. tapered leaf‡
- — Springs, rear – 11,000-lb. single variable rate
- ● Springs, rear – 13,500-lb. single variable rate‡‡
- ● Tires – 225/70R19.5 Goodyear G647RSS;†† load-range F (6)
- ○ Tires – 225/70R19.5 Michelin XZE, load-range F (6)
- ● Wheels – 19.5" x 6" hub-piloted, 10-lug, painted-white steel (6)
- ○ Wheels – 19.5" x 6" hub-piloted, 10-lug, polished-aluminum (6)

L45

L55

EXTERIOR

- ○ Backup alarm
- ○ Daytime running lamps
- ○ Grille – Chromed
- ○ Taillamp delete

INTERIOR

- ○ Air conditioning
- ● AM/FM stereo with clock
- ○ AM/FM stereo with single-CD player and clock
- ○ Interior Upgrade Package – Includes air conditioning with integral heater/defroster, power door locks, power windows, one-touch-down power driver's window, cloth-trimmed seats, remote keyless-entry system with panic alarm and audible lock confirmation
- ○ Radio Prep Package – Includes wiring and antenna with multiple dual-cone speakers; radio not included

● Standard ○ Optional — Not Available

*Requires 7000-lb. front springs.
 **Requires 13,500-lb. rear springs.
 †Not available with 113" wheelbase.
 ††Late availability.
 ‡Requires 7000-lb. front axle.
 ‡‡Requires 13,500-lb. rear axle.

Comparisons based on 2005 competitive models, publicly available information and Ford certification data at time of printing. Some features discussed may be optional. Vehicles shown may contain optional and aftermarket upfit equipment. Features shown may be offered only in combination with other options or subject to additional ordering requirements or limitations. Following publication of the catalog, certain changes in standard equipment, options and the like, or product delays may have occurred which would not be included in these pages. Your Ford Dealer is the best source for up-to-date information. Ford Division reserves the right to change product specifications at any time without incurring obligations. Body Manufacturers are responsible for compliance certification of the completed vehicle. The Ford LCF Limited Warranty and any government certification made by Ford shall cover only the vehicle as manufactured by Ford and shall not extend to any addition, modification or change of or to the vehicle by the Ford Authorized Pool Account.

DIMENSIONS

- A. Bumper-to-back-of-cab (BBC) – 63.3"
- B. Bumper-to-front-axle (BA) – 44.2"
- C. Frame to top of cab – 61.9"
- D. Top of cab from ground – 90.2"
- E. Step to ground – 18"
- F. Cab sill to ground – 35.1"
- G. Frame height at center line of axle, front (unloaded) – 28.3"
- H. Frame height at center line of axle, rear (unloaded) – 30.0"
- I. Bumper width – 82.9"
- J. Fender width – 82.9"
- K. Overall width, front – 87.2"
Overall width, rear – 93.6" (not shown)
- L. Track, front – 73.4"
Track, rear – 74.0" (not shown)
- Door opening – 65° (not shown)
- Cab tilt angle – 43° (not shown)

DIMENSIONS

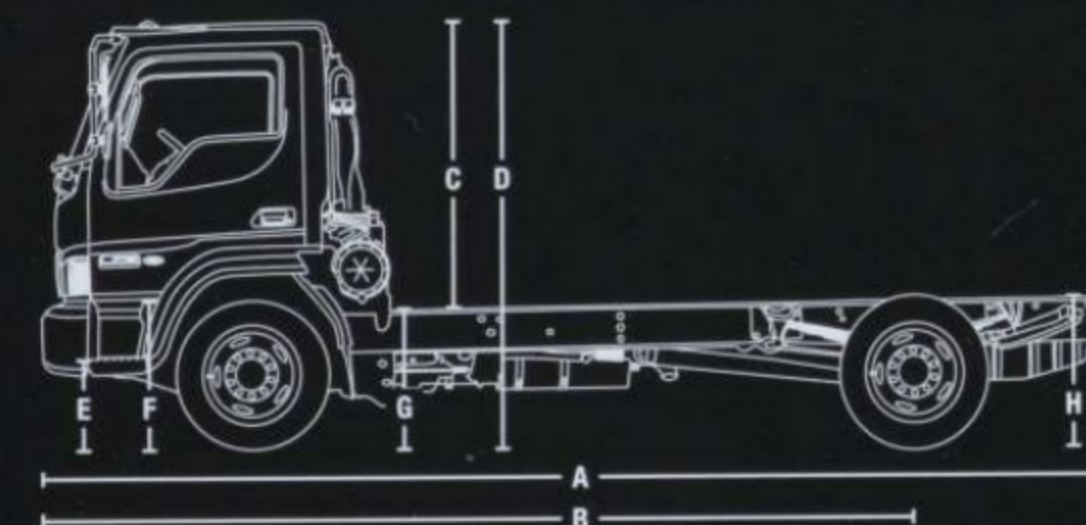



WE'VE GOT YOUR BACK

When you're in charge, it's a 24/7 commitment – there's no quitting time. So you need dependable, reliable equipment you can trust to keep up the pace. Look no further than Ford LCF. Designed and Built Ford Tough, the all-new Ford LCF is backed by our extensive network of over 500 Ford LCF-certified Truck Dealers. They'll help keep your trucks and business rolling with certified mechanics and ready access to up-time critical parts, which adds up to less downtime and more productivity for you and your business.

BUSINESS PREFERRED NETWORK/ LIMITED WARRANTY



Each of the select dealerships in our **BUSINESS PREFERRED NETWORK (BPN)** is committed to providing you and your business with quality commercial-oriented products and service – as well as special financing and billing arrangements. As a BPN customer, your business vehicles receive priority service at your BPN dealership to help get them back on the road quickly.

The Ford LCF **LIMITED WARRANTY** provides 2-year/unlimited-miles coverage on the cab/chassis, 3-year/unlimited-miles coverage on the 4.5L Power Stroke® V6 Turbo Diesel and 5-speed TorqShift™ automatic transmission, 4-year/unlimited-miles coverage against corrosion perforation and 5-year/unlimited-miles coverage on frame rails. Ask your Ford LCF-Certified Truck Dealer for complete details.

Whether you plan to purchase or lease, the Ford **EXTENDED SERVICE PLAN (ESP)** gives you extra peace of mind. It's designed to protect you from the cost of unexpected repairs by covering key vehicle components. Be sure to ask your dealer for an ESP backed by Ford Motor Company and honored at all LCF-certified Ford dealerships.

If you plan to purchase your new LCF, **FORD CREDIT** offers commercial purchase plans with attractive rates, negotiable terms and business-friendly options. If you prefer to lease, you should consider the variety of package options offered through our CommercialLease and CommercialLeasePlus.® To learn more, call 1-877-234-FMCC (3622) or visit our Web site at fordcredit.com.



2006 FORD LCF

THE ALL-NEW BUILT FORD TOUGH TRUCK

DESIGNED AND BUILT TO MEET THE DEMANDS
OF NORTH AMERICAN BUSINESS

BEST-IN-CLASS TURNING RADIUS

- 16'5" CURB-TO-CURB
- 18'4" WALL-TO-WALL
- 53° WHEEL CUTS

BEST-IN-CLASS POWER AND TORQUE

- NEW 4.5L POWER STROKE® V6 TURBO DIESEL
 - 220 HORSEPOWER
 - 440 LB.-FT. OF TORQUE
- 2 MILLION MILES OF TESTING

CAPABLE WORK TRUCKS

- STANDARD GVWRs OF 16,000 AND 19,500 LBS.
 - STRONGEST STANDARD FRAME
 - 4-WHEEL DISC ABS
- EXCLUSIVE HUCK-BOLT FRAME CONSTRUCTION
 - 19.5" WHEELS AND TIRES

QUICK AND FLEXIBLE ORDERING

- 9 NO-CHARGE EXTERIOR COLOR CHOICES
 - STANDARD VINYL INTERIOR TRIM
- INTERIOR UPGRADE PACKAGE WITH CLOTH TRIM
FOR ADDITIONAL COMFORT AND CONVENIENCE

For more information on Ford Commercial Vehicles,
go to www.commtruck.ford.com

