

Outback | 2025



The Subaru Outback. **Go where love takes you.**





Inspiring out-of-office memos since '95.

Meet the 2025 Subaru Outback.

The first Outback wasn't just a way to get out there, but a reason to see something new—to have an adventure. That was 1995, and still, the Outback continues to push ahead. From its advanced technologies and safety systems to its capable engineering, this SUV lets you know the outdoors is waiting. So take a personal day—or two.



Outback Limited in Crimson Red Pearl.

1 EPA-estimated fuel economy for 2025 Outback 2.5L trim levels at 32 highway mpg. Actual mileage may vary. 2 Comparison based on competitor information from manufacturer websites for non-hybrid 2025 model-year vehicles within the IHS Markit Non-Luxury CUV segment and current at time of printing. 3 Availability varies by trim level. See your Subaru retailer for details. 4 Based on Experian Automotive vehicles in operation vs. total new registrations for MY2013-2022 as of December 2022. 5 EyeSight is a driver assist technology, which may not operate optimally under all driving conditions. The driver is always responsible for safe and attentive driving. System effectiveness depends on many factors such as vehicle maintenance, weather and road conditions. See your Owner's Manual for complete details on system operations and limitations. 6 Automatic Emergency Steering requires Blind-Spot Detection. Not available on base Outback trim level; optional on Premium trim level. See your Subaru retailer for details. 7 The DriverFocus Distraction Mitigation System is a driver recognition technology designed to alert drivers if their attention to the road wavers or if the driver's face appears to turn away. The driver is always responsible for safe and attentive driving. System effectiveness may be affected by articles of clothing worn on the head or face. See your Owner's Manual for complete details on system operation and limitations. 8 Requires Keyless Access with Push-Button Start and subscription to STARLINK Safety and Security Plus services. 6-month free trial included. Not available in all states. See your Subaru retailer for details.

Most Adventurous

With standard Subaru Symmetrical All-Wheel Drive, 8.7 inches of ground clearance and a direct injection SUBARU BOXER® engine, the 2025 Outback is designed for peace of mind on long drives, achieving up to 32 MPG¹—better AWD fuel economy than the Honda Passport, Ford Edge and Jeep Grand Cherokee.² For next-level capability, you can opt for a turbocharged engine³—or get it standard with the Outback Wilderness, which features 9.5 inches of ground clearance.

Most Reliable

Built on the strength of the Subaru Global Platform, the Outback has had years of experience on all types of terrain. Its record speaks for itself—97% of Subaru Outback vehicles sold in the last 10 years are still on the road today.⁴

Safest

The 2025 Outback takes an active role in helping you stay safe, thanks to innovations such as standard Subaru EyeSight® Driver Assist Technology,⁵ which includes Advanced Adaptive Cruise Control with Lane Centering and Automatic Emergency Steering.⁶ There's also the DriverFocus® Distraction Mitigation System^{3,7} to help reduce distracted or drowsy driving.

Most Advanced

More options mean more ease. An 11.6-inch touchscreen³ makes it easy to find what you need, while SUBARU STARLINK® Multimedia lets you connect just about anywhere through standard Apple CarPlay® and Android Auto™ integration with available wireless connectivity.³ Technologies such as Remote Engine Start with Climate Control^{3,8} help make the Outback a place of comfort.



Farther doesn't have to feel longer.

To keep distances engaging, the Outback delivers far-reaching connectivity. With its large 11.6-inch touchscreen interface,¹ you have simple, easy access to SUBARU STARLINK Multimedia, with available wireless connectivity¹ for Apple CarPlay[®] and Android Auto[™] integration. For passengers, built-in Wi-Fi hotspot capability^{1,2} offers a wide range of entertainment possibilities. Once everyone votes on what music to play, the Harman Kardon[®] premium audio system will bring that song to life through 12 speakers and a 576-watt-equivalent amplifier.¹

Outback Touring with Java Brown Nappa Leather.



SUBARU STARLINK 11.6-inch Multimedia Navigation System¹



Heated rear seats and USB-A and USB-C charge ports¹



Harman Kardon[®] premium audio system¹

Welcoming you, personally.

From the moment you sit behind the wheel, available DriverFocus recognizes you and automatically adjusts the Outback to your preferences.¹ This includes driver seat settings, climate controls, exterior mirrors and even your choices for which vehicle system information appears on the screen.

¹ Availability varies by trim level. See your Subaru retailer for details. ² Activation and subscription required. Internet access is purchased separately through AT&T with monthly, per gigabyte, and unlimited data options available. Existing AT&T customers have the option to add a line to their AT&T Mobile Share plan. See your Subaru retailer for details.

Find a place that makes you
forget to take a selfie.



The Outback is engineered to help you discover what's out there. When pavement is scarce, you can count on standard Subaru Symmetrical All-Wheel Drive, X-MODE® with Hill Descent Control and ample ground clearance. For packing up with ease, there are roof rails with integrated retractable roof crossbars.¹ Plus, the Outback has a towing capacity of up to 3,500 pounds,² meaning you can bring all your must-haves—and fun-to-haves, too.



Outback Wilderness in Geyser Blue with optional equipment.

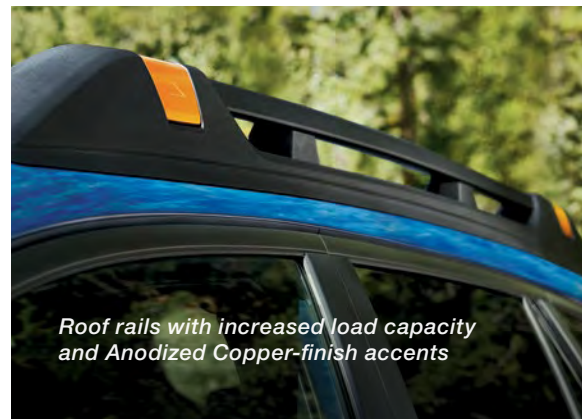

Roof rails with increased load capacity and Anodized Copper-finish accents



9.5 inches of ground clearance

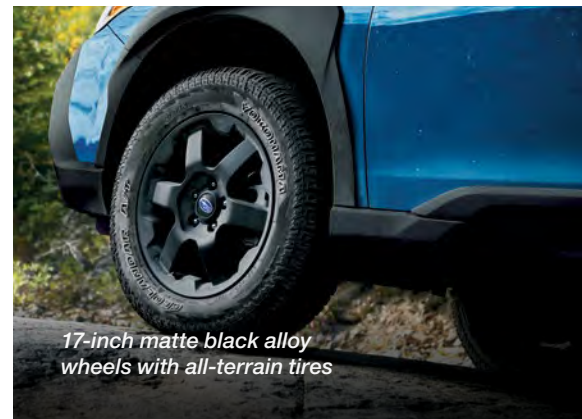

17-inch matte black alloy wheels with all-terrain tires



Anti-glare hood decal

The Outback Wilderness

Your itinerary becomes anywhere in the Outback Wilderness—an Outback that's heightened, quite literally, with 9.5 inches of ground clearance. Its rugged front bumper cladding and grille, along with Anodized Copper-finish accents, reveal its bold nature, while its capable engineering drives the point home. For more fun while taking on the terrain, the Outback Wilderness is equipped with a further advanced dual-function X-MODE system designed to work at higher speeds. This is combined with off-road-optimized gearing as well as increased approach, departure and breakover angles for tackling a greater variety of surfaces. The Outback Wilderness also has ladder-type roof rails for an increased roof load capacity and comes with additional tow points for greater confidence when heading out.

¹ Availability varies by trim level. See your Subaru retailer for details. ² Outback XT trim levels only. Trailer brakes may be needed. Some safety features, including X-MODE, Blind-Spot Detection and Rear Cross-Traffic Alert, may not function properly when towing. See your Subaru retailer for details.



An extra set of eyes every time you drive.

Every Outback includes standard Subaru EyeSight Driver Assist Technology,¹ with available Automatic Emergency Steering.² Equipped with a comprehensive suite of innovative safety features, EyeSight looks ahead, alerts you to potential dangers and can even intervene to help you avoid a collision.



Outback Touring in Cosmic Blue Pearl.



Pre-Collision Braking

Can help slow and bring your Outback to a full stop if necessary.



Lane Departure and Sway Warning

Can alert you if you drift to the edge of your lane and begin to cross into another.



Advanced Adaptive Cruise Control with Lane Centering

Automatically helps keep you centered in your lane, at a safe distance behind the car in front of you—even in traffic and around curves.



Pre-Collision Throttle Management

Can reduce engine power to help give you more time to react and to help minimize possible impact force in case of a collision.

¹ EyeSight is a driver assist technology, which may not operate optimally under all driving conditions. The driver is always responsible for safe and attentive driving. System effectiveness depends on many factors such as vehicle maintenance, weather and road conditions. See your Owner's Manual for complete details on system operations and limitations. ² Automatic Emergency Steering requires Blind-Spot Detection. Availability varies by trim level. See your Subaru retailer for details.

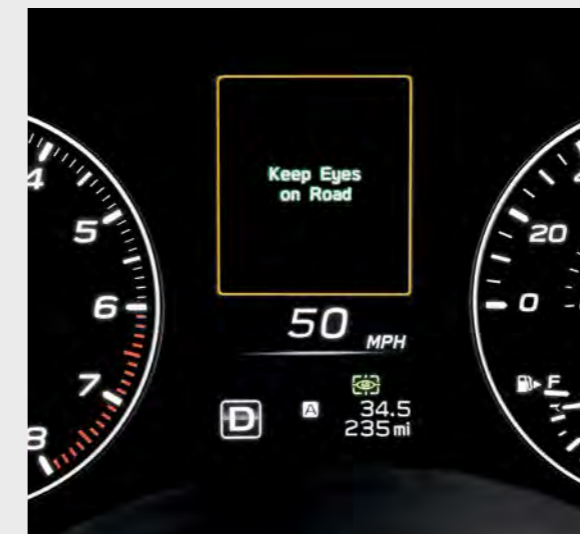

Every day in the U.S., more than 1,000 people are injured in crashes reported to have involved a distracted driver.¹ As an industry leader in safety, Subaru developed the DriverFocus Distraction Mitigation System,^{2,3} one of the first technologies of its kind. Engineered for both new and experienced drivers, it works together with Subaru EyeSight to help detect distracted or drowsy driving. If the driver's attention strays from the road for too long, DriverFocus can deliver visual and auditory alerts to bring attention back to the road.

¹ Centers for Disease Control and Prevention, citing National Center for Statistics and Analysis. Distracted Driving: 2015, in Traffic Safety Research Notes. DOT HS 812 381. March 2017, National Highway Traffic Safety Administration: Washington, D.C. ² The DriverFocus Distraction Mitigation System is a driver recognition technology designed to alert drivers if their attention to the road wavers or if the driver's face appears to turn away. The driver is always responsible for safe and attentive driving. System effectiveness may be affected by articles of clothing worn on the head or face. See your Owner's Manual for complete details on system operation and limitations. ³ Availability varies by trim level. See your Subaru retailer for details.

Detect, alert, protect.

Advanced Safety Features

The Outback represents the very latest in Subaru safety, down to the strong core of its Subaru Global Platform. For better visibility, there are standard LED Steering Responsive Headlights with High Beam Assist and an available 180-Degree Front View Monitor.¹ Thanks to a wide range of active safety technologies, peace of mind is possible just about anywhere.

Outback Onyx Edition XT in Cosmic Blue Pearl with optional and accessory equipment.



Blind-Spot Detection

Using radar sensors, Blind-Spot Detection^{1,2} warns you with a visual indicator on your exterior mirror if the system detects a vehicle in your blind spot. Another feature of this system, Lane Change Assist, alerts you with a flashing indicator on your exterior mirror if it senses a vehicle approaching at a higher speed in a neighboring lane and you signal for a lane change.



Rear Cross-Traffic Alert

Rear Cross-Traffic Alert^{1,2} uses radar sensors to help warn you of traffic approaching from the side as you are backing up, utilizing a flashing visual indicator on your exterior mirror and Rear-Vision Camera display as well as an audible warning.



Reverse Automatic Braking

Reverse Automatic Braking^{1,3} can detect objects directly behind your vehicle when backing up at a low speed and can help bring the Outback to a stop should an object be detected within its range and the brakes have yet to be applied. There's also the Rear-Vision Camera to help you keep an eye out.



SUBARU STARLINK Safety and Security

The Outback features the latest STARLINK[®] Safety and Security^{1,4} system, which can alert a first responder in an emergency, help police locate your vehicle if it's stolen and more. To get you started, new Outback drivers enjoy a free three-year STARLINK Safety Plus trial, which includes Advanced Automatic Collision Notification, Enhanced Roadside Assistance, SOS Emergency Assistance and more.

¹ Availability varies by trim level. See your Subaru retailer for details. ² Blind-Spot Detection, Lane Change Assist and Rear Cross-Traffic Alert are systems designed to assist the driver by monitoring the rear and side areas of the vehicle during a lane change or reversing and are not a substitute for safe and attentive driving. ³ The Reverse Automatic Braking System is not a substitute for safe and attentive driving. System effectiveness depends on many factors, such as vehicle maintenance, weather and road conditions. Always exercise caution and use vehicle mirrors and the Rear-Vision Camera when backing up. See your Owner's Manual for complete details on system operation and limitations. ⁴ Activation with subscription required. Includes a 3-year trial subscription to STARLINK Safety Plus services and a 6-month trial subscription to STARLINK Safety and Security Plus services. The Concierge plan can be purchased annually or monthly. A credit card on file will be required for specific packages and for renewal purposes. Not available in all states. See your Subaru retailer for details.



Rest stops aren't the only
chances to stretch.

1 Without available power moonroof. See your Subaru retailer for details. 2 Comparison based on competitor information from manufacturer websites for 2022 model-year vehicles within the IHS Markit Non-Luxury CUV segment and current at time of printing. 3 Availability varies by trim level. See your Subaru retailer for details. 4 Requires Keyless Access with Push-Button Start and subscription to STARLINK Safety and Security Plus services. 6-month free trial included. Not available in all states. See your Subaru retailer for details. 5 Touring and Touring XT trim levels only. See your Subaru retailer for details.

Outback Limited with Warm Ivory Leather.

Expanding Possibility

Space goes a long way in the Outback, and with up to 109.0 cubic feet of passenger volume,¹ it's roomier than the Kia Sorento, Honda CR-V and Toyota RAV4.² A vast cargo area offers versatility with conveniences including a Hands-Free Power Rear Gate,³ a 60/40-split folding rear seatback and LED cargo and rear gate lights.³ When it comes to comfort, you can set the perfect temperature even before you step in, thanks to Remote Engine Start with Climate Control.^{3,4} Once inside, you're welcomed by genuine Nappa leather⁵ and a 12-way power-adjustable driver seat.³ There's also an 8-way power front-passenger seat,³ along with heated³ and ventilated front seats,⁵ heated rear seats³ and even a heated steering wheel.³ When the moment calls for calm, you'll have as much as you need—this is the quietest Outback interior yet.

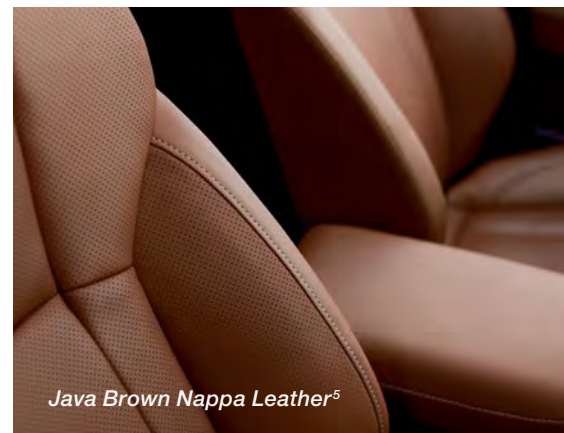

Java Brown Nappa Leather⁵



Two-position memory driver seat and exterior mirrors³



Rear-seat comfort

2025 Outback | Trim Levels



Outback

- 182-hp 2.5-liter 4-cylinder SUBARU BOXER engine with direct injection
- Subaru Symmetrical All-Wheel Drive with Active Torque Vectoring
- Lineartronic® CVT (Continuously Variable Transmission) with 8-speed manual-mode paddle shifters
- X-MODE featuring Hill Descent Control
- 2,700-lb. towing capacity¹
- Auto Start-Stop System
- Auto-on/off LED Steering Responsive Headlights with High Beam Assist
- LED fog lights
- 17-inch aluminum-alloy wheels. Black with machine finish.
- Roof rails with integrated retractable crossbars and 4 tie-down points
- Cloth upholstery
- 6-way manually adjustable driver seat and 4-way manually adjustable front-passenger seat
- 8 cup and bottle holders
- SUBARU STARLINK Dual 7.0-inch Multimedia with Apple CarPlay® and Android Auto™ integration, SiriusXM² including 4-month trial and SiriusXM Travel Link^{®2} trial, USB-A input port, Bluetooth® and 4 speakers
- Automatic climate control system with air filtration
- Driver and front-passenger auto-up/down power windows
- Cargo-area tray, 4 tie-down hooks and 2 grocery bag hooks
- EyeSight Driver Assist Technology³: Pre-Collision Braking System, Pre-Collision Throttle Management, Lane Departure and Sway Warning with Lane Departure Prevention, Advanced Adaptive Cruise Control with Lane Centering
- 8 airbags (SRS)⁴: dual-stage deployment driver and front-passenger, driver's knee, front-passenger seat cushion, front and rear outboard occupant side curtain with rollover sensor, and seat-mounted front side impact
- Whiplash-reducing front seats with height-adjustable head restraints
- Height-adjustable 3-point front seatbelts with pretensioners and adaptive load limiters and 3-point seatbelts for all rear seating positions
- Front/rear passenger seatbelt warning light/chime, rear-seat reminder and child-safety rear door locks
- LATCH system: Lower Anchors and Tethers for CHildren
- Rear-Vision Camera with washer



Outback Premium

- Includes Outback key features and adds:**
- Crystal Black Silica finish exterior mirrors with integrated turn signals
 - LED rear gate light
 - Privacy glass
 - All-Weather Package: Heated exterior mirrors, 3-mode heated front seats, windshield wiper de-icer
 - 10-way power-adjustable driver seat with 2-way lumbar support
 - Leather-wrapped steering wheel and shifter handle
 - SUBARU STARLINK 11.6-inch Multimedia Plus with wireless Apple CarPlay® and Android Auto™ integration, SiriusXM² with 360L including 4-month trial and SiriusXM Travel Link^{®2} trial, USB-A and USB-C input ports, Bluetooth® and 6 speakers
 - 4G LTE Wi-Fi capability⁵
 - Dual-zone automatic climate control system with air filtration
 - Single USB-A and USB-C rear-seat charge ports and A/C vents
 - Center console 12-volt power outlet
 - Lifting and retractable cargo-area cover
 - STARLINK Safety and Security enabled⁶: Includes features and services such as Advanced Automatic Collision Notification, SOS Emergency Assistance, Enhanced Roadside Assistance, Maintenance Notifications, Vehicle Health Reports, Diagnostic Alerts, Remote Engine Start with Climate Control,⁷ Remote Lock/Unlock, Concierge Services and more

Optional Packages

Option Package (OP 13): • Keyless Access with Push-Button Start • Hands-Free Power Rear Gate • Blind-Spot Detection with Lane Change Assist and Rear Cross-Traffic Alert⁸ • Automatic Emergency Steering³

Option Package (OP 15): • Keyless Access with Push-Button Start • Hands-Free Power Rear Gate • Blind-Spot Detection with Lane Change Assist and Rear Cross-Traffic Alert⁸ • Automatic Emergency Steering³ • Power moonroof • SUBARU STARLINK 11.6-inch Multimedia Navigation System



Outback Onyx Edition

- Includes Outback Premium key features and adds:**
- Dual-Mode X-MODE with Snow/Dirt and Deep Snow/Mud modes
 - 18-inch aluminum-alloy wheels with black finish
 - Power moonroof
 - Crystal Black Silica front grille
 - Black badging and window moldings
 - Hands-Free Power Rear Gate with vehicle lock button
 - Keyless Access with Push-Button Start
 - Gray StarTex® water-repellent upholstery with green contrast stitching
 - Heated steering wheel
 - Harman Kardon® 576-watt-equivalent premium audio system with 12 speakers
 - Auto-up/down front and rear windows
 - Auto-dimming rearview compass mirror with HomeLink®
 - 8 cargo-area tie-down hooks
 - EyeSight Driver Assist Technology with Automatic Emergency Steering³
 - Blind-Spot Detection with Lane Change Assist and Rear Cross-Traffic Alert⁸
 - Reverse Automatic Braking⁹

Outback Onyx Edition XT

- Includes Outback Onyx Edition features and adds:**
- 260-hp 2.4-liter 4-cylinder direct injection turbocharged SUBARU BOXER engine
 - Lineartronic CVT (Continuously Variable Transmission) High Torque with 8-speed manual-mode paddle shifters
 - 3,500-lb. towing capacity¹
 - Full-size spare tire
 - 8-way power-adjustable front-passenger seat
 - Heated outboard rear seats
 - 180-Degree Front View Monitor



Outback Wilderness

- Includes Outback Premium key features and adds:**
- 260-hp 2.4-liter 4-cylinder direct injection turbocharged SUBARU BOXER engine
 - Lineartronic CVT (Continuously Variable Transmission) High Torque with 8-speed manual-mode paddle shifters
 - Advanced Dual-Mode X-MODE with Snow/Dirt and Deep Snow/Mud modes, low speed/low ratio gradient control and medium-to-high-speed gravel/dirt functions
 - 9.5 inches of ground clearance
 - 3,500-lb. towing capacity¹
 - 4 tow points with Anodized Copper-finish covers
 - 17-inch aluminum-alloy wheels with matte black finish and Yokohama® Geolandar® All-Terrain tires
 - Hexagonal LED fog lights
 - Outback Wilderness-design front and rear bumper covers, fender flares and side cladding
 - Outback Wilderness-design front grille
 - Matte-black, anti-glare hood decal
 - Ladder-style roof rails with increased load-carrying capacity, 4 tie-down points and Anodized Copper-finish accents
 - Subaru Wilderness badging on front doors and rear gate
 - Black badging and window moldings
 - Hands-Free Power Rear Gate with vehicle lock button
 - Full-size spare tire
 - Outback Wilderness Gray StarTex water-repellent upholstery with Anodized Copper-finish accents and contrast stitching
 - Outback Wilderness-design all-weather floor mats
 - Outback Wilderness-design cargo-area tray
 - Outback Wilderness gauges with color LCD display and Anodized Copper accents
 - Heated steering wheel
 - 8-way power-adjustable front-passenger seat
 - Heated outboard rear seats
 - Keyless Access with Push-Button Start
 - Auto-up/down front and rear windows
 - Auto-dimming rearview compass mirror with HomeLink®
 - 8 cargo-area tie-down hooks
 - Harman Kardon® 576-watt-equivalent premium audio system with 12 speakers
 - EyeSight Driver Assist Technology with Automatic Emergency Steering³
 - Blind-Spot Detection with Lane Change Assist and Rear Cross-Traffic Alert⁸
 - 180-Degree Front View Monitor

Optional Package

Option Package (OP 22): • Power moonroof • SUBARU STARLINK 11.6-inch Multimedia Navigation System • Reverse Automatic Braking⁹



Outback Limited

- Includes Outback Premium key features and adds:**
- 18-inch aluminum-alloy wheels. Black with machine finish.
 - Silver metallic finish front and rear bumper underguards
 - Hands-Free Power Rear Gate with vehicle lock button
 - Automatic tilt-down passenger-side mirror
 - Power moonroof
 - Keyless Access with Push-Button Start
 - Leather-trimmed upholstery
 - 12-way power-adjustable driver seat with 4-way lumbar support
 - 8-way power-adjustable front-passenger seat
 - Adjustable driver-seat thigh support
 - Two-position memory driver seat and exterior mirrors
 - Heated steering wheel
 - Heated outboard rear seats
 - SUBARU STARLINK 11.6-inch Multimedia Navigation with 3 years of free map updates, SiriusXM² with 360L including 4-month trial, SiriusXM Traffic¹¹ trial and SiriusXM Travel Link^{®11} trial
 - Harman Kardon® 576-watt-equivalent premium audio system with 12 speakers
 - Auto-up/down front and rear windows
 - Auto-dimming rearview compass mirror with HomeLink®
 - EyeSight Driver Assist Technology with Automatic Emergency Steering³
 - Blind-Spot Detection with Lane Change Assist and Rear Cross-Traffic Alert⁸
 - Reverse Automatic Braking⁹
 - DriverFocus Distraction Mitigation System¹⁰

Outback Limited XT

- Includes Outback Limited key features and adds:**
- 260-hp 2.4-liter 4-cylinder direct injection turbocharged SUBARU BOXER engine
 - Lineartronic CVT (Continuously Variable Transmission) High Torque with 8-speed manual-mode paddle shifters
 - 3,500-lb. towing capacity¹



Outback Touring

- Includes Outback Limited key features and adds:**
- Automatic power-folding exterior mirrors with satin chrome
 - Roof rails with silver-finish integrated retractable crossbars and 4 tie-down points
 - Body-color door handles with chrome inserts
 - Crystal Black Silica finish pillar trim
 - 180-Degree Front View Monitor
 - Nappa leather-trimmed upholstery
 - High-grade leather-wrapped steering wheel
 - 3-mode ventilated front seats
 - Smart auto-dimming rearview compass mirror with HomeLink®
 - 8 cargo-area tie-down hooks

Outback Touring XT

- Includes Outback Touring key features and adds:**
- 260-hp 2.4-liter 4-cylinder direct injection turbocharged SUBARU BOXER engine
 - Lineartronic CVT (Continuously Variable Transmission) High Torque with 8-speed manual-mode paddle shifters
 - 3,500-lb. towing capacity¹



Information current at time of printing.

Visit www.subaru.com for the most up-to-date product information.

2025 Outback | Specifications

Engine		Outback	Outback XT
Power Torque	2.5-liter DOHC direct injection aluminum-alloy 16-valve 4-cylinder horizontally opposed SUBARU BOXER engine with Dual Active Valve Control System (DAVCS). 182 hp @ 5,800 rpm 176 lb-ft @ 4,400 rpm	●	—
	2.4-liter DOHC, Direct Injection Turbocharged (DIT), intercooled, aluminum-alloy 16-valve 4-cylinder horizontally opposed SUBARU BOXER engine with Dual Active Valve Control System (DAVCS). 260 hp @ 5,600 rpm 277 lb-ft @ 2,000–4,800 rpm	—	●
Traction and Stability			
X-MODE	X-MODE optimizes engine output and transmission ratio, increases all-wheel drive system engagement and uses enhanced control of the Vehicle Dynamics Control system to reduce or increase individual wheelspin, providing optimal traction on various types of terrain and low friction surfaces. Outback, Outback Premium, Outback Limited/XT and Outback Touring/XT: Standard. Single-mode system. Outback Onyx Edition/XT: Standard. Dual-mode system with Snow/Dirt and Deep Snow/Mud modes. Outback Wilderness: Advanced dual-mode system with Snow/Dirt and Deep Snow/Mud modes, low speed/low ratio gradient control and medium-to-high-speed gravel/dirt functions.	●	●
Hill Descent Control (HDC)	X-MODE also incorporates Hill Descent Control that helps to maintain a constant vehicle speed when traveling downhill, enhancing vehicle control.	●	●
Active Torque Vectoring	Active Torque Vectoring works in tandem with the Vehicle Dynamics Control system applying braking power to the inside wheels, resulting in better handling, sharper turn-in, more neutral steering and higher cornering limits when turning.	●	●

● Standard ○ Optional — Not equipped

2025 Outback | Specifications

Traction and Stability (continued)		Outback	Outback XT
Auto Vehicle Hold (AVH)	AVH helps to reduce driver fatigue by holding the vehicle in place when the vehicle is stopped, after the brake pedal has been released. Utilizing the Vehicle Dynamics Control system and the Electronic Parking Brake, AVH can hold the vehicle stationary on level, decline or incline surfaces.	●	●
Fuel			
Fuel Economy	city/highway/combined ¹²	26/32/28 mpg	22/29/25 mpg Outback Wilderness: 21/26/23 mpg
Fuel Requirement	Unleaded gasoline (87 octane)	●	●
Fuel Capacity	18.5 gallons	●	●
Chassis			
Steering	Electric power-assisted quick ratio rack-and-pinion steering (EPAS). Turning circle: 36.1 feet.	●	●
Suspension	Front: Strut type with internal rebound spring. Aluminum-alloy lower L-arm. Stabilizer bar. Rear: Double-wishbone. Stabilizer bar.	●	●
Brakes	4-wheel ventilated disc ABS with Electronic Brake-force Distribution (EBD)	●	●
Brake Override System	If both brake and accelerator pedals are pressed simultaneously, the system reduces the operation of the accelerator pedal to help prevent unintentional vehicle acceleration.	●	●

15 | 2025 Outback



The 2024 Subaru Outback is an IIHS TOP SAFETY PICK.



97% of Subaru Outback vehicles sold in the last 10 years are still on the road today.¹³



Subaru is ranked #1 in product quality for three years running.¹⁴



The Subaru Outback is an IntelliChoice SmartChoice winner for Cost of Ownership.¹⁵

2025 Outback | Equipment

Exterior	Outback	Outback Premium	Outback Onyx Ed. / XT	Outback Wilderness	Outback Limited / XT	Outback Touring / XT
Silver metallic finish front and rear bumper underguards	☐	☐	—	—	●	●
Automatic tilt-down passenger-side mirror	—	—	—	—	●	●
Power tilt/sliding-glass moonroof (95% UV light-reducing) ¹⁶	—	○ ¹⁷	●	○ ¹⁷	●	●
Seating and Trim						
6-way manually adjustable driver seat	●	—	—	—	—	—
10-way power-adjustable driver seat with 2-way adjustable lumbar support	—	●	●	●	—	—
12-way power-adjustable driver seat with 4-way adjustable lumbar support	—	—	—	—	●	●
4-way manually adjustable front-passenger seat	●	●	● / —	—	—	—
8-way power-adjustable front-passenger seat	—	—	— / ●	●	●	●
Adjustable driver-seat thigh support	—	—	—	—	●	●
Heated front seats (All-Weather Package)	—	●	●	●	●	●
Heated outboard rear seats	—	—	— / ●	●	●	●
3-mode ventilated front seats	—	—	—	—	—	●
360-degree heated steering wheel	—	—	●	●	●	●
Convenience Features						
Keyless Access with Push-Button Start	—	○ ¹⁷	●	●	●	●
Hands-Free Power Rear Gate with automatic close, height memory function and vehicle lock button	—	○ ¹⁷	●	●	●	●
Two-position memory driver seat and exterior mirrors	—	—	—	—	●	●

● Standard ○ Optional — Not equipped ☐ Available retailer-installed accessory

2025 Outback | Equipment

Convenience Features (continued)	Outback	Outback Premium	Outback Onyx Ed. / XT	Outback Wilderness	Outback Limited / XT	Outback Touring / XT
Auto-dimming rearview compass mirror with HomeLink®	☐	☐	●	●	●	—
Smart auto-dimming rearview compass mirror with HomeLink®	—	—	—	—	—	●
Rear-seat auto-up/down power windows	—	—	●	●	●	●
Audio and Communication Systems						
SUBARU STARLINK Dual 7.0-inch Multimedia with Apple CarPlay® and Android Auto™ integration, SiriusXM² including 4-month trial and SiriusXM Travel Link ^{®2} trial, USB-A input port, Bluetooth® and 4 speakers	●	—	—	—	—	—
SUBARU STARLINK 11.6-inch Multimedia Plus with wireless Apple CarPlay® and Android Auto™ integration, SiriusXM² with 360L including 4-month trial and SiriusXM Travel Link ^{®2} trial, USB-A and USB-C input ports, and Bluetooth®	—	●	●	●	—	—
SUBARU STARLINK 11.6-inch Multimedia Navigation System with 3 years of free map updates, wireless Apple CarPlay® and Android Auto™ integration, SiriusXM² with 360L including 4-month trial, 3-year SiriusXM Traffic ¹¹ trial and SiriusXM Travel Link ^{®11} trial, USB-A and USB-C input ports, and Bluetooth®	—	○ ¹⁷	—	○ ¹⁷	●	●
6 speakers	—	●	—	—	—	—
Harman Kardon® premium system with 576-watt-equivalent amplifier and 12 speakers, including center dash speaker and subwoofer	—	—	●	●	●	●
Safety						
ACTIVE						
Blind-Spot Detection with Lane Change Assist and Rear Cross-Traffic Alert [®]	—	○ ¹⁷	●	●	●	●
Reverse Automatic Braking (RAB) ⁹	—	—	●	○ ¹⁷	●	●
DriverFocus Distraction Mitigation System (DMS) ¹⁰	—	—	—	—	●	●
180-Degree Front View Monitor	—	—	— / ●	●	—	●

Outback | Accessories



Thule® Portable Step. Get the extra height you need to easily access your rooftop accessories. This portable step is made of heavy-duty steel and includes rubber bumpers to help prevent wheel scuffs. Conveniently folds into a carrying bag for easy storage.



Wireless Charger. Simply place any Qi® or Samsung® Fast Charge-enabled devices onto the anti-slip rubber insert and charge. The Wireless Charger is a Qi® Certified Device with Intelligent Charging Profiles, battery protection, temperature control and short circuit safeguards.



Rear Seatback Protector. Provides additional protection to the rear seatback when lowering the seats to transport larger cargo.

Use in conjunction with the Cargo Tray for maximum protection.



Auto-Dimming Exterior Mirrors with Approach Light. Designed to enhance nighttime driving safety by reducing headlight glare. Upon approaching the vehicle or unlocking your doors with the keyless entry system, LED lights in each exterior mirror illuminate the ground next to the vehicle's doors.

Requires Auto-Dimming (Interior) Mirror.



17 | 2025 Outback

Subaru Loves Pets

Introducing Genuine Subaru Pet-friendly Accessories.

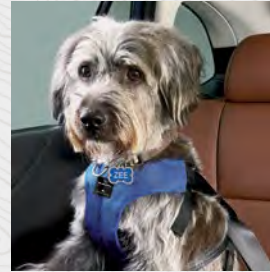

Pet Harness. Keep your dog safe with this crash-tested Pet Harness, certified by the Center for Pet Safety for dogs from 18 to 90 pounds. Manufactured by Sleepypod® in signature Subaru blue, the Pet Harness can also be used for walking your dog. Available in S, M, L or XL.



Seat Cover – Rear. Keep your second row tidy with this custom-fitted seat cover, made with water-resistant heavy-duty materials.



Console Lid Protector. Protects the center console lid surface from nail scratches and puncture holes while providing a comfortable armrest for front-seat passengers.

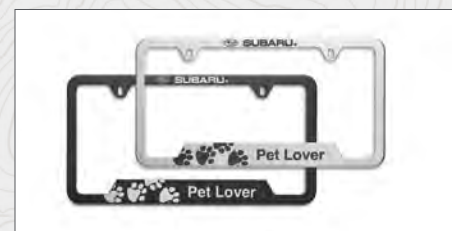

License Plate Frame – Pet Lover. Share your love for your furry, scaly or feathered friends with our Pet Lover license plate frame. Available in either matte black or polished stainless steel.



Pet-friendly Padded Cargo Liner. Thick padding and a durable polyester shell provide a comfortable resting area for your pet while protecting the cargo and seatback areas. This accessory includes a foldout bumper protector and is compatible with the 60/40 seats up or down.



Pet Carrier and Mobile Pet Bed. This multi-functional ultra-plush pet bed also doubles as a carrier to safely transport your pet in comfort. Manufactured by Sleepypod®, this accessory is crash-tested and certified by the Center for Pet Safety.



Collapsible Pet Kennel. Portable, compact and lightweight, the Collapsible Pet Kennel, manufactured by Thule®, is ideal for travel and for everyday transport. Includes a carrying handle for easy transport and two pockets to carry your pet's personal cargo.



Pet Rear Door Protector. If you're bringing along your furry companion, this lightweight, durable Pet Rear Door Protector helps keep your door panel free from scratches, scuffs and, yes, even drool. Manufactured with heavy-duty polyester and designed to seamlessly fit the contours of your door. Comes in a set of two.



Cargo Net. Neatly holds cargo and prevents it from sliding while the vehicle is in motion. Either anchor it to the sides of the cargo area to help prevent shifting from front to back or lay it across the floor to help keep things from rolling around.



Cargo Sidewall Protector. Durably constructed to protect the rear cargo area and wheel well trim panels. Sidewall Protectors are removable for easy clean-up. Use in conjunction with the Rear Seatback Protector and factory-installed Cargo Tray for optimal protection. Set of two.



Door Scuff Protector. A durable, easy-to-clean plastic shell that protects your doors from common scuffs and scrapes. The unique texture complements the design of the Outback. Comes in a set of four.



Mud Flaps. Provides a barrier to help protect your Outback from the elements while also preventing minor road debris from kicking up behind your vehicle. Special edition designed for Outback Wilderness includes a stylish mountain scene molded into the lower portion of the product.



All-Weather Floor Liners. Custom-fitted, high-wall floor liners help protect carpeting from spills, snow, sand, mud, dirt and moisture. Liners are engineered for a precise fit and tested for durability.



Remote Engine Starter. Lets you start the Outback from a distance of up to 400 feet, allowing the interior to reach a comfortable temperature upon entry. This accessory is an alternative for customers who do not enroll in STARLINK Safety and Security Plus.



Body Side Molding. Attractive color-matched moldings coordinate with the styling of the vehicle while helping to protect doors from unsightly dings.



Trailer Hitch. Heavy-duty 2-inch receiver rated at 3,500 lbs. towing capacity, 350 lbs. tongue weight for the 2.4L Turbo XT and Outback Wilderness models, and 2,700 lbs. towing capacity, 270 lbs. tongue weight for the naturally aspirated 2.5L.

Trailer hitch requires the hitch and harness for proper operation and safety compliance. Hitch ball not included.

For a complete list of available accessories, visit your local Subaru retailer or visit www.subaru.com



Thule® Bike Carrier – Roof Mounted



Thule® Cargo Carrier – Extended



Thule® Heavy-Duty Roof Cargo Basket

Outfit your Outback.

When your passion is even bigger than your cargo area, Genuine Subaru active lifestyle accessory attachments manufactured by Thule® are a smart way to securely transport larger gear like bikes, skis, snowboards, kayaks, paddleboards and more. Each carrier safely attaches to your roof rack, and the available Thule® Portable Step can help you easily access everything.

2025 Outback | Owner Benefits

For additional Subaru resources, including owner's manuals, maintenance schedules, roadside assistance and more, log on to www.mysubaru.com

Protecting Your Investment

Once you're part of our family, we'll be there for you. Every Subaru comes with 24-hour roadside assistance for 3 years or 36,000 miles. And to protect you over the long haul, we offer Added Security®, which helps protect your car for up to 10 years or 100,000 miles with extended service agreements and maintenance plans backed by Subaru. And because we've been backing them for more than 30 years, they're agreements you can trust. Your retailer has full coverage details.



More Than a Car Company®.



For us, love is about the commitments we make. The Subaru Love Promise® is our vision to show love and respect to all people and the planet we all share. Subaru is headquartered in a zero-landfill office in Camden, N.J., and in 2004, Subaru of Indiana Automotive, Inc. (SIA) became the first manufacturing facility in the U.S. to reach zero-landfill status—nothing from its manufacturing efforts ever goes into a landfill.



Warranties

New Car Limited Warranty	3 years or 36,000 miles, whichever comes first.
Powertrain Limited Warranty	5 years or 60,000 miles, whichever comes first.
Wear Item Limited Warranty	3 years or 36,000 miles, whichever comes first. Repairs to the following items will also be covered under Wear Item Limited Warranty: <ul style="list-style-type: none"> • Brake Pads • Wiper Blades • Clutch Linings • Transmitter Batteries
Rust Perforation Limited Warranty	5 years, unlimited mileage.
24-hour Roadside Assistance	3 years or 36,000 miles, whichever comes first.

1 Trailer brakes may be needed. Some safety features, including X-MODE, Blind-Spot Detection and Rear Cross-Traffic Alert, may not function properly when towing. See your Subaru retailer for details. 2 All SiriusXM services require a subscription, sold separately by SiriusXM after the trial period. Your SiriusXM service will automatically stop at the end of your trial unless you decide to subscribe. If you decide to continue service after the trial, the subscription plan chosen will automatically renew and be charged according to your chosen payment method at the then-current rates. Fees and taxes apply. See the SiriusXM Customer Agreement & Privacy Policy at www.siriusxm.com for full terms and how to cancel, which includes online methods or calling 1-866-635-2349. Available in the 48 contiguous United States, D.C., and Puerto Rico (with coverage limits and capable receiver). Visit www.siriusxm.com/FADS for most current service area information. Availability of some services and features is subject to device capabilities and location restrictions. All fees, content and features are subject to change. SiriusXM, SiriusXM Traffic, SiriusXM Travel Link® and all related logos are trademarks of Sirius XM Radio Inc. and its respective subsidiaries. Other marks, channel names and logos are the property of their respective owners. All rights reserved. SiriusXM with 360L: Certain features and/or content may not be available unless an active data connection is enabled in the vehicle. Content varies by SiriusXM subscription. Features may vary by make/model. 3 EyeSight is a driver assist technology, which may not operate optimally under all driving conditions. The driver is always responsible for safe and attentive driving. System effectiveness depends on many factors such as vehicle maintenance, weather and road conditions. The Pre-Collision Braking System is designed to provide automatic braking that either prevents a collision or reduces the severity of a frontal impact. Pre-Collision Throttle Management is designed to reduce acceleration and minimize the severity of certain frontal impacts. Advanced Adaptive Cruise Control, Brake Light Recognition and Automatic Emergency Steering are designed to assist the driver and are not substitutes for safe and attentive driving. Automatic Emergency Steering availability varies by trim level and works in conjunction with and after Pre-Collision Braking has been activated by providing steering support at speeds lower than 50 mph to try and help avoid a collision. Lane centering function operates only when used in conjunction with Advanced Adaptive Cruise Control. Lane Departure and Sway Warning with Lane Departure Prevention operates only when the lane markings are visible, and its effectiveness depends on many factors. See your Owner's Manual for complete details on system operation and limitations. 4 The Supplemental Restraint System (SRS) (airbags) affords the driver and the front passenger additional protection in moderate to severe frontal and side-impact collisions and outboard 2nd-row passengers additional protection in moderate to severe side-impact collisions. This system provides supplemental protection only, and seatbelts must be worn in order to avoid injuries to out-of-position occupants upon airbag deployment and to provide the best combined protection in a serious accident. Children should always be properly restrained in one of the rear seats. See your Owner's Manual for recommended seating position. 5 Activation and subscription required. Internet access is purchased separately through AT&T with monthly, per gigabyte, and unlimited data options available. Existing AT&T customers have the option to add a line to their AT&T Mobile Share plan. See your Subaru retailer for details. 6 Activation with subscription required. Includes a 3-year trial subscription to STARLINK Safety Plus services and a 6-month trial subscription to STARLINK Safety and Security Plus services. The Concierge plan can be purchased annually or monthly. A credit card on file will be required for specific packages and for renewal purposes. Not available in all states. See your Subaru retailer for details. 7 Requires Keyless Access with Push-Button Start. Not available in all states. See your Subaru retailer for details. 8 Blind-Spot Detection, Lane Change Assist and Rear Cross-Traffic Alert are systems designed to assist the driver by monitoring the rear and side areas of the vehicle during a lane change or reversing and are not a substitute for safe and attentive driving. 9 The Reverse Automatic Braking System is not a substitute for safe and attentive driving. System effectiveness depends on many factors, such as vehicle maintenance, weather and road conditions. Always exercise caution and use vehicle mirrors and the Rear-Vision Camera when backing up. See your Owner's Manual for complete details on system operation and limitations. 10 DriverFocus Distraction Mitigation System is a driver recognition technology designed to alert drivers if their attention to the road wavers or if the driver's face appears to turn away. The driver is always responsible for safe and attentive driving. System effectiveness may be affected by articles of clothing worn on the head or face. See your Owner's Manual for complete details on system operation and limitations. 11 Activation and monthly subscription sold separately. Includes 3-year trial subscription. See your Subaru retailer for details. 12 2025 EPA fuel economy estimates. Actual mileage may vary. 13 Based on Experian Automotive vehicles in operation vs. total new registrations for MY2014-2023 as of December 2023. 14 Compared to all other measured mass-market automotive companies in the 2023 American Customer Satisfaction Index (ACSI)® surveys of customers rating their own automotive company's performance. The #1 rating is shared with one other automotive company, ACSI and its logo are registered trademarks of the American Customer Satisfaction Index, LLC. 15 2023 IntelliChoice 5-Year Cost of Ownership Study © 2024 MOTOR TREND GROUP, LLC. 16 The glass information listed represents calculated reference values and may not represent actual values determined by testing. 17 Available only with other features. See optional equipment listing on trims page.

2025 Outback | Dimensions

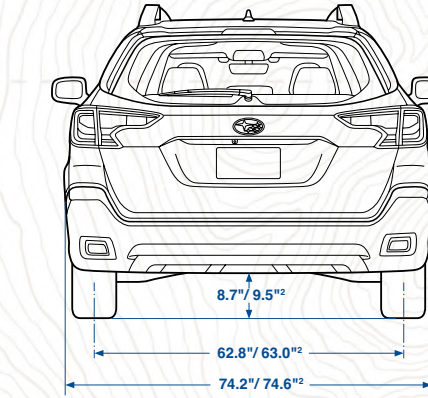
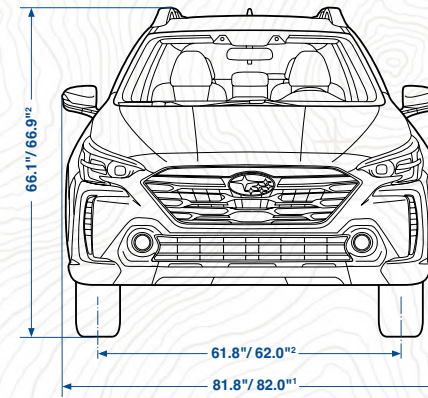
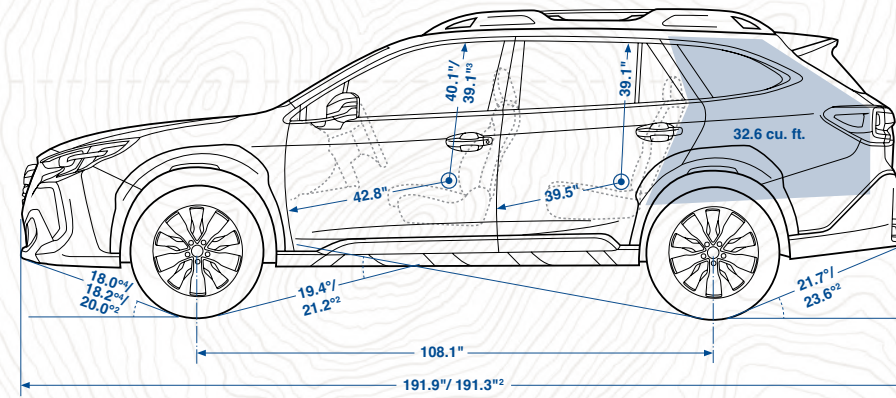
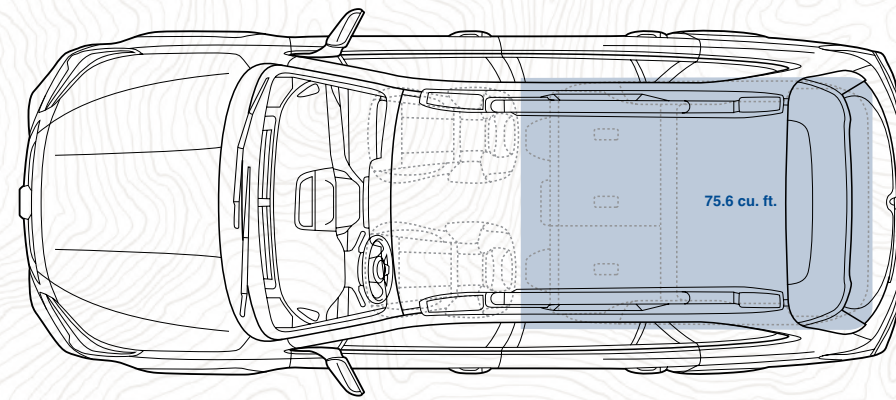

Length	191.9 inches Outback Wilderness: 191.3 inches	Roof crossbar load capacity	Outback, Outback Premium, Outback Onyx/XT, Outback Limited/XT, Outback Touring/XT: 150-lb. dynamic maximum crossbar load capacity
Width	74.2 inches, Outback Wilderness: 74.6 inches (81.8 inches/82.0 inches, including mirrors)	Roof rail load capacity	Outback Wilderness: 700-lb. static maximum load capacity
Height	66.1 inches Outback Wilderness: 66.9 inches	Ground clearance	8.7 inches (at curb weight) Outback Wilderness: 9.5 inches (at curb weight)
Wheelbase	108.1 inches	Approach angle	18.0°/18.2°/ Outback Wilderness: 20.0°
Track (front/rear)	61.8 inches/62.8 inches Outback Wilderness: 62.0 inches/63.0 inches	Departure angle	21.7°/ Outback Wilderness: 23.6°
Base curb weight	Outback: 3,641 lbs. Outback Premium: 3,661 lbs. Outback Limited: 3,766 lbs. Outback Touring: 3,781 lbs. Outback Onyx Edition XT: 3,921 lbs. Outback Wilderness: 3,902 lbs. Outback Limited XT: 3,931 lbs. Outback Touring XT: 3,946 lbs.	Breakover angle	19.4°/ Outback Wilderness: 21.2°
Towing capacity¹	Outback: 2,700 lbs. Outback XT: 3,500 lbs.	Headroom (front/rear)	40.1 inches/39.1 inches (with available moonroof: 39.1 inches/39.1 inches)
		Legroom (front/rear)	42.8 inches/39.5 inches
		Shoulder room (front/rear)	58.1 inches/57.4 inches
		Hip room (front/rear)	55.5 inches/54.8 inches
		Passenger volume	109.0 cubic feet (with available moonroof: 107.5 cubic feet)
		Cargo volume	32.6 cubic feet
		Maximum cargo volume	75.6 cubic feet with rear seatback folded

1 With integrated turn signals. 2 Outback Wilderness trim level. 3 With available moonroof. 4 18.2 degrees for Outback, Outback Premium and Outback Onyx Edition/XT trim levels. 18.0 degrees for Limited/XT and Touring/XT trim levels. 5 Certain limitations apply. Trailer brakes may be needed. Some safety features, including X-MODE, Blind-Spot Detection and Rear Cross-Traffic Alert, may not function properly when towing. See your Subaru retailer for details.

Some images shown are for illustration purposes only. Specifications and imagery in this brochure are based on the latest product information available at the time of publication. Production models may vary. For the most up-to-date and detailed product information, log on to www.subaru.com. Some equipment shown in photography in this brochure is optional at extra cost. Specific options may be available only in combination with other options. Specific combinations of equipment or features may vary from time to time and by geographic area. Certain accessories and equipment may not be available at the time of publication. Subaru of America, Inc., reserves the right to change or discontinue at any time, without notice, prices, colors, materials, equipment, accessories, specifications, models and packages without incurring any obligation to make the same or similar changes on vehicles previously sold. Colors shown may vary due to reproduction and printing processes.

This brochure was prepared by Subaru of America, Inc. Every owner of the car during the warranty period shall be entitled to the benefit of these warranties. Subaru, SUBARU BOXER, SUBARU STARLINK, STARLINK, EyeSight, Wilderness, Lineartronic and X-MODE are registered trademarks of Subaru Corporation. Added Security, DriverFocus, Love, It's what makes Subaru, Subaru, Love Promise, More Than a Car Company, Outback, StarTex, Subaru Loves Learning, Subaru Loves Pets, Subaru Loves the Earth, Subaru Loves to Care and Subaru Loves to Help are registered trademarks of Subaru of America, Inc. ACSI® and its logo are registered trademarks of The American Customer Satisfaction Index, LLC. Android Auto™ is a trademark of Google LLC. Apple CarPlay® is a registered trademark of Apple Inc. Bluetooth® is a registered trademark of Bluetooth SIG, Inc. Experian® and its logo are registered trademarks of Experian Information Solutions, Inc. Forest Stewardship Council®, FSC® and the FSC® checkmark-and-tree logo are registered trademarks of Forest Stewardship Council AC. Harman Kardon® is a registered trademark of Harman International Industries, Inc. HomeLink® and the HomeLink® house icon are registered trademarks of Genie Corporation. IHS™ is a trademark of the Insurance Institute for Highway Safety. Motor Trend® and IntelliChoice® are registered trademarks of Motor Trend Group, LLC. Qi® is a registered trademark of Wireless Power Consortium, Inc. Samsung® is a registered trademark of Samsung Electronics Co., Ltd. SiriusXM, SiriusXM Traffic, SiriusXM Travel Link® and all related logos are trademarks of Sirius XM Radio Inc. and its respective subsidiaries. Other marks, channel names and logos are the property of their respective owners. All rights reserved. Sleepypod® is a registered trademark of Launchlab Corp. Thule® is a registered trademark of the Thule Group. Yokohama® and Geolandar® are registered trademarks of Yokohama Tire Company. For more information, contact your Subaru retailer, or log on to www.subaru.com.

2025 Outback | Colors

Paint

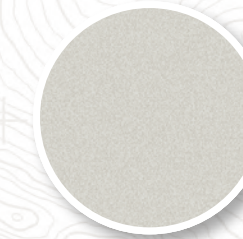

Crystal White Pearl

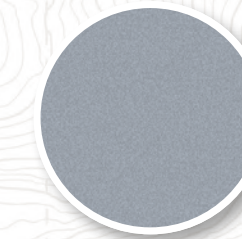

Ice Silver Metallic

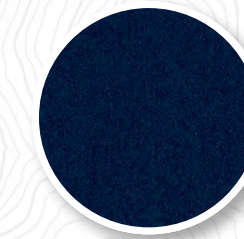

Cosmic Blue Pearl

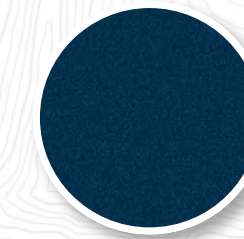

Geyser Blue

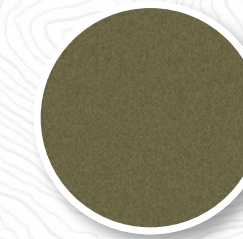

Autumn Green Metallic

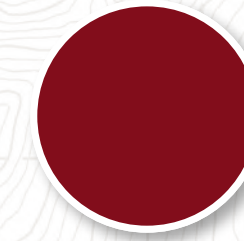

Crimson Red Pearl

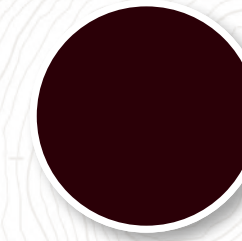

Dark Mahogany Pearl

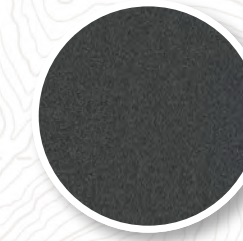

Magnetite Gray Metallic

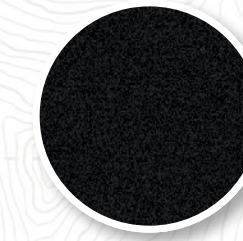

Crystal Black Silica

Upholstery

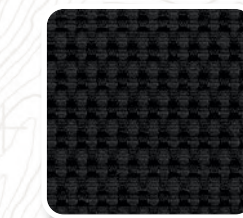

Slate Black Cloth (SBC)

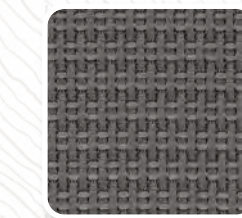

Titanium Gray Cloth (TGC)

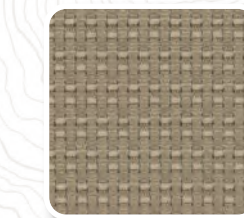

Warm Ivory Cloth (WIC)



Gray StarTex (GST)

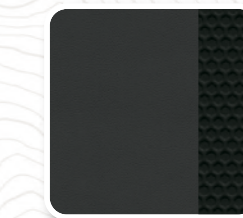

Outback Wilderness Gray StarTex (GS2)



Slate Black Leather (SBL)

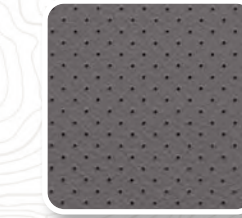

Titanium Gray Leather (TGL)



Warm Ivory Leather (WIL)

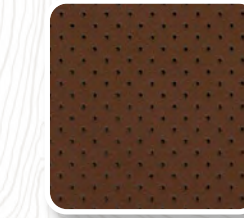

Java Brown Nappa Leather (JNL)



Slate Black Nappa Leather (SNL)

Color Combinations

	Outback	Outback Premium	Outback Onyx Edition/XT	Outback Wilderness	Outback Limited/Limited XT	Outback Touring/Touring XT
Crystal White Pearl	SBC	SBC or TGC	GST	GS2	SBL or WIL	JNL or SNL
Ice Silver Metallic	SBC	SBC or TGC	GST	GS2	SBL or TGL	SNL
Cosmic Blue Pearl	SBC	SBC or TGC	GST	—	SBL or TGL	JNL or SNL
Geyser Blue	—	—	—	GS2	—	—
Autumn Green Metallic	—	SBC or WIC	GST	GS2	SBL or WIL	JNL or SNL
Crimson Red Pearl	—	SBC	—	—	SBL	SNL
Dark Mahogany Pearl	—	—	—	—	SBL	SNL
Magnetite Gray Metallic	SBC	SBC or TGC	GST	GS2	SBL or TGL	JNL or SNL
Crystal Black Silica	SBC	SBC or TGC	GST	GS2	SBL or WIL	JNL or SNL

— Not available



See 2025 models in action



youtube.com/subaru

These brochures were printed with vegetable-based inks and produced using a "Green Printing Process." The Forest Stewardship Council® (FSC) is an international organization that brings people together to find solutions which promote responsible stewardship of the world's forests and environments.

By producing these brochures in a green way rather than by traditional methods, we saved 93 trees preserved for the future; 30,000 gallons of wastewater flow saved; 400 lbs solid waste not generated; 53,000 lbs net greenhouse gases prevented; 40,000,000 BTUs energy not consumed. Calculations provided by Environmental Paper Network. FSC® is not responsible for any calculations on saving resources by choosing this paper.

This brochure is printed in the U.S.A. on 10% recycled paper. ©2024 Subaru of America, Inc. 25.OBKSRB.525 (DSGN-P671, 200K, 5/24, KSL)

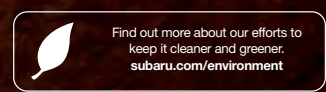

Love. It's what makes Subaru, Subaru.®

