



ALL-NEW 2025

# QX80



↓ SWIPE

# Jump to a Section

Tap an arrow to skip to section

---

## Design

Exterior, Interior, Space & Cargo



## Onboard Tech

Comfort & Convenience, Infotainment



## Drive Tech & Performance

Driver Assist Technology, Performance



## Style & Specs

Style, Specs, Trims



## Accessories

Exterior, Interior, Cargo, Towing,  
Lighting & Tech And Pet



# Design

Exterior



---

Interior



---

Space & Cargo



---

Back to Menu



Build & Price →



THE ALL-NEW 2025 QX80

# An Invitation To Share



[BACK TO SECTION](#)



**THE ALL-NEW 2025 QX80**

The journey is the reward, and sharing it with others makes it all the more meaningful. The all-new 2025 INFINITI QX80 is your space to savor life's in-between moments in luxurious comfort and sophisticated style, turning them into lasting memories with whomever you invite along for the ride.



**THE ALL-NEW 2025 QX80**

As you approach QX80, the **INFINITI Light Path**<sup>1</sup> illuminates your walkway to invite you closer, while the **approach unlock & walk away lock** feature senses your presence and unlocks doors for you. At the same time, the **Flush Door Handles** extend in greeting. Altogether, it's an embodied experience of hospitality.





FRONT DESIGN CUES

# Elegance That Draws Guests In





**FRONT DESIGN CUES**

Lead from the front with the impressively redesigned Piano Black **waterfall grille**, inspired by the Kyoto bamboo forest and featuring an all-new **INFINITI Radiant® Grille Emblem**.

Together with the graceful dance of the **Digital Piano Key signature lighting**, QX80 draws the eye in and down the infinite road, luminously intersecting the distant horizon.



Waterfall grille



INFINITI Radiant Grille Emblem

## FRONT DESIGN CUES

Complemented by its **wide stance** and available **22-inch aluminum-alloy wheels**, the QX80 projects a bold, quiet confidence that draws attention without ever calling for it.



22-inch AUTOGRAPH aluminum-alloy wheels<sup>1</sup>



REAR DESIGN CUES

Style That Turns  
Its Back on No One





## REAR DESIGN CUES

Make an exit worthy of your entrance – impressive yet boastless. The new **light curtain rear taillights**, complemented by the **Digital Piano Key lighting**, dazzle onlookers as more than 300 micro LED lights illuminate the entire width of the QX80 to create an effortlessly spectacular finish.



Light curtain rear taillights



Digital Piano Key lighting

**REAR DESIGN CUES**

As you depart, onlookers will notice how the windows and **"floating" roofline** gracefully melt into one another to form a sleek, fluid profile and wonder where the night will take you and your companions next.



"Floating" roofline



QX80

Interior



LUXURIOUS INTERIOR FOR ALL

Exclusivity for  
Everyone





**LUXURIOUS INTERIOR FOR ALL**

Success is a shared endeavor, and the QX80 invites those who have helped you get there to revel in it – with first-class seating in every row and available 14-way power front seats.



**LUXURIOUS INTERIOR FOR ALL**

With available **semi-aniline leather-appointed seats**, captain's chairs in the first two rows and an available **Rear Control Panel** with touch-screen functionality and haptic feedback, you can extend premium comfort – and control – to you and your guests.



Semi-aniline leather-appointed seats<sup>1</sup>



Rear Control Panel<sup>1</sup>

QX80

Interior



SEATING

Room for Life





## SEATING

Design your QX80 around your hosting needs, with a choice to **seat either seven or eight passengers**. Standard on the AUTOGRAPH trim, the seven-seater allows your second-row guests to luxuriate in their very own captain's chairs. Or, opt for the eight-seat configuration, available on the PURE, LUXE and SENSORY trims, to maximize your hosting potential with second- and third-row bench seats.

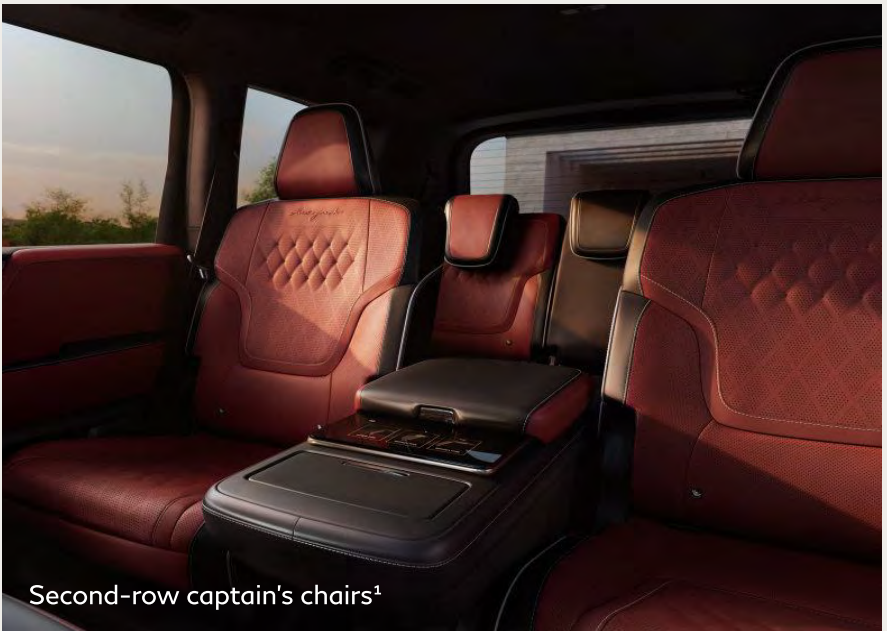

Second-row captain's chairs<sup>1</sup>

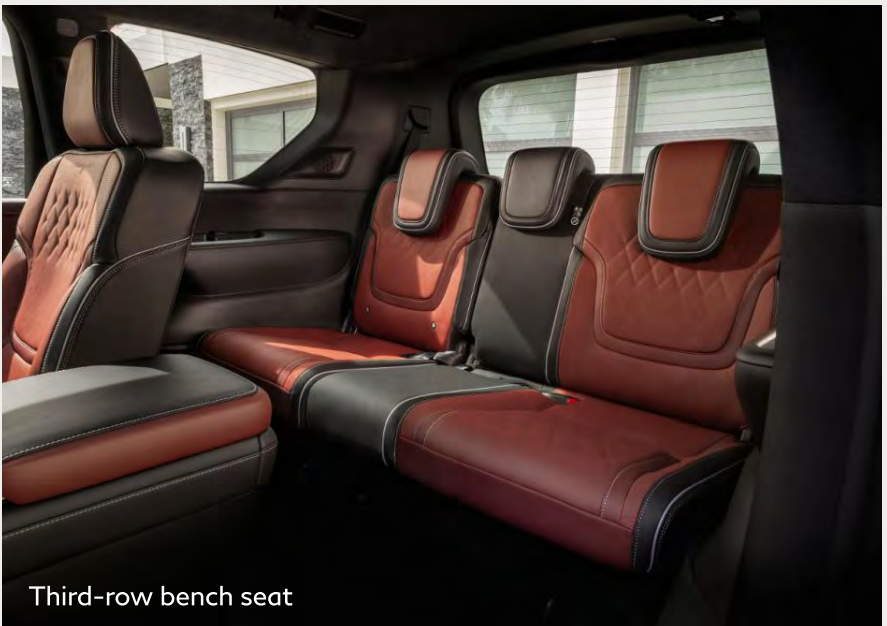

Third-row bench seat

QX80

Interior

DESIGN INTRICACIES

# A World of Detail



## DESIGN INTRICACIES

It takes a trained eye to properly notice the subtle inspirations of true craftsmanship, though all will immediately feel its powerful effects. The **key fob's ridged pattern** is inspired by the summer kimono design worn by the samurai. The available **Open Pore Ash Wood with Metal Inlay interior trim**, fashioned after the silver strings of a traditional koto instrument, creates unique reflectivity depending on the angle of the light. These details are both inspired and inspiring.



Open Pore Ash Wood with Metal Inlay interior trim<sup>1</sup>



**DESIGN INTRICACIES**

The available **diamond pattern** on the captain's chairs features perforations with dot-quilting to create a subtle pillowing effect. Rather than abruptly ending, the pattern gently fades into nothingness as it reaches the edge of the seat. Similar in subtlety, the **seamless leather-wrapped dash** is hand-stretched and fitted for a refined seamlessness that elevates what would otherwise be ordinary. It's a detail that requires the delicate touch of a skilled artisan.

Diamond-pattern dot-quilting<sup>1</sup>

Seamless leather-wrapped dash

CARGO CONFIGURATIONS

# Reconfiguration-Ready



**CARGO CONFIGURATIONS**

Life is filled with shifting needs, and QX80 is equipped to adapt to yours at a moment's notice. When your hands are full, the **Motion-Activated Liftgate** allows you to easily access the **101 cu. ft. of cargo room** created with the second and third-row seats down without lifting a finger.<sup>2</sup>



Power 60:40-split third-row seats down



**CARGO CONFIGURATIONS**

Conveniently access the available **Remote Control Rear Seats** – via the front-row center console touch-screen display or from the cargo area – raise or lower the second-row captain's chairs and third row bench seats in various configurations to suit your cargo needs.<sup>2,3,4</sup>



Remote Control Rear Seats<sup>1,3</sup>



Power Luggage Control

# Onboard Tech

Audio Tech



Infotainment



Personalization Tech



Back to Menu



Build & Price →

QX80

Audio Tech



KLIPSCH REFERENCE PREMIERE™

High Fidelity





**KLIPSCH REFERENCE PREMIERE™**

Klipsch® takes its premium sound system on the road. More akin to a concert hall than an SUV, the **24 high-performance speakers** of the available Klipsch Reference Premiere™ Audio System evenly distribute an **immersive 3D surround sound** experience. The **noise-canceling DynamicAudioReveal™** technology helps bring out the emotion and clarity of every note.<sup>1</sup>



Klipsch Reference Premiere™ Audio System<sup>1</sup>

**KLIPSCH REFERENCE PREMIERE™**

When a call comes in, the music doesn't have to go out. **Individual Audio** creates an isolated sound zone through speakers in the headrest, allowing the driver to have a quiet phone conversation even as passengers enjoy the music. **Advanced directional microphones** pick up only the driver's voice, ensuring a clean call where no one is interrupted.<sup>1,5,6</sup>

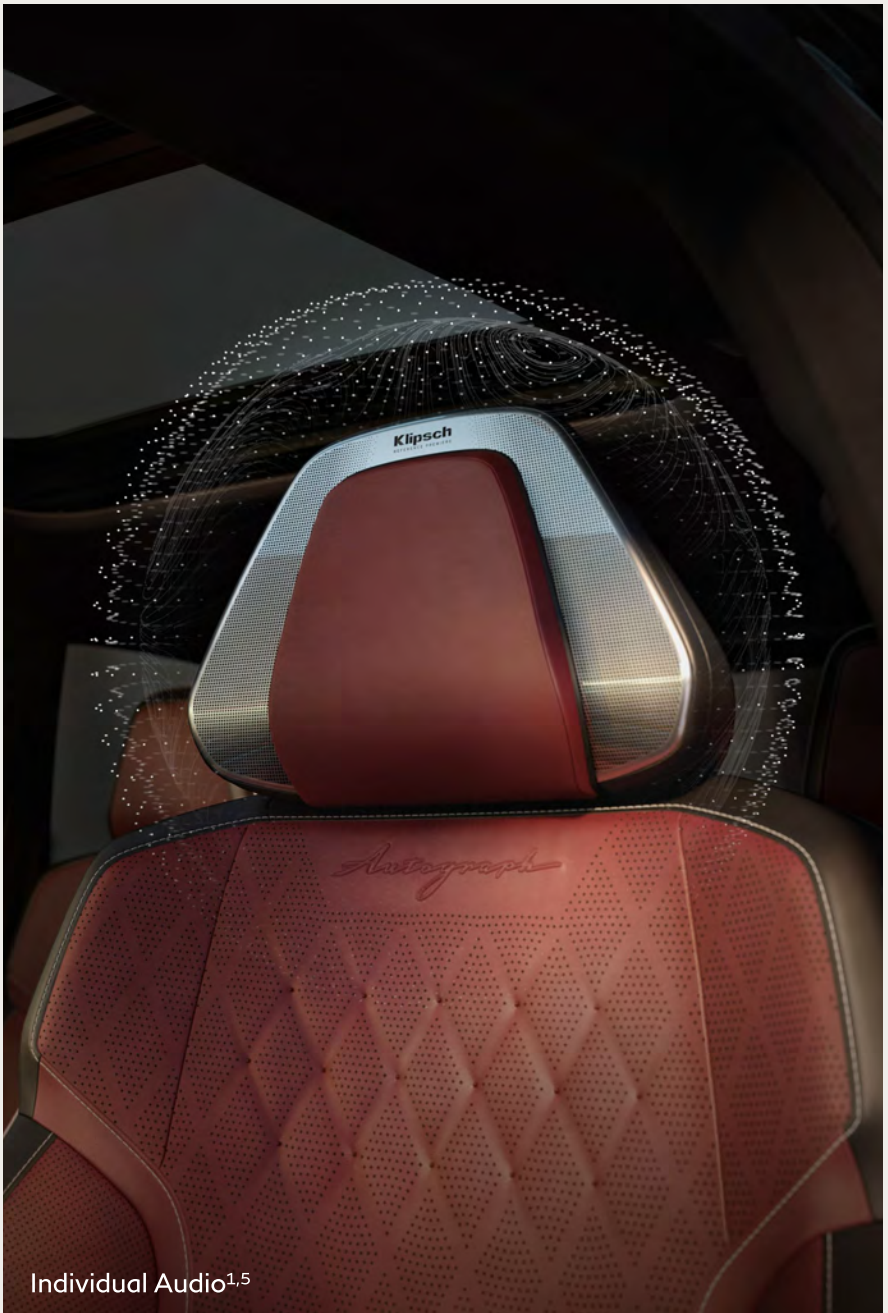



QX80

Infotainment



INTUITIVE DISPLAYS

Life on Full Display





## INTUITIVE DISPLAYS

Harmonize the serenity of what's outside with the comfort of what's inside. Showcased on **Dual 14.3" Displays**, the intuitive **Live Wallpaper** instinctively adapts to the weather and time of day, while the available **Personalized Ambient Lighting** features 64 unique color selections that can be adjusted to reflect the current season.<sup>4,7</sup> When it's numbers you need, the **Head-Up Display** projects pertinent information, like speed limits and turn-by-turn navigation, directly onto the windshield.<sup>1,8,9</sup>



## INTUITIVE DISPLAYS

Have eyes on what matters. The available **INFINITI Dash Cam Recorder** captures front and rear exterior footage for added peace of mind. Standard on the AUTOGRAPH trim, the **in-car camera** allows you to view the interior on the center screen and zoom into rear rows to record special rear-seat moments that can be shared with friends and family. Left something behind? Simply access the camera via the MyINFINITI app on your smartphone to check for forgotten items.<sup>1,6,10</sup>



QX80

Infotainment



GOOGLE BUILT-IN

Your World,  
With You





**GOOGLE BUILT-IN**

With **Google built-in** native to QX80, your INFINITI becomes your smartphone. Simply log in with your existing Google account to access your favorite apps, including maps, music and more. And with intuitive voice activation, adjusting the climate control, setting your navigation and responding to messages are all a simple "Hey Google" away.<sup>4,9,11,12</sup>



Google built-in<sup>4,11</sup>

**GOOGLE BUILT-IN**

# Just Ask Google<sup>11</sup>

**GOOGLE MAPS™**

Becomes your built-in navigation system and integrates across displays so you stay connected and up-to-date<sup>9,11</sup>

**GOOGLE ASSISTANT**

Brings Google into your QX80 as a vocal co-pilot that continuously learns, allowing you to leverage vehicle functions, such as adjusting the seats, monitoring cameras and setting the climate control<sup>10,11</sup>

**GOOGLE PLAY™ STORE**

Includes apps for music, video and messaging and can add new features and entertainment as they develop<sup>11,12</sup>

CONNECTIVITY

# Connection Is in the Air





**CONNECTIVITY**

Seamless smartphone connectivity now comes standard. With wireless **Apple CarPlay**<sup>®</sup> integration, QX80 becomes a natural extension of your compatible iPhone<sup>®</sup>, so you can listen to your messages, select a podcast, stream your music and more – all on the touch-screen display without dealing with cumbersome cables and messy wires.<sup>4,6,12</sup>



**CONNECTIVITY**

For the first time in an INFINITI, **Android Auto™** goes wireless, so you can connect your compatible Android™ phone and access your favorite apps with no cords required. And when you need to charge, simply rest your compatible smartphone on the **wireless charging pad**.<sup>4,6</sup>



QX80

Personalization Tech

CUTTING-EDGE COMFORT

Achieve Equilibrium





**CUTTING-EDGE COMFORT**

QX80 has guest comfort down to a science. If a first- or second-row passenger enters feeling too warm, available **Biometric Cooling** will detect their body temperature using infrared scanning and intuitively adjust the fan speed and temperature, creating thermal bliss – all without needing to push a button.<sup>13</sup> Helping reduce the effects of light, heat and ultraviolet and infrared rays are **UV and IR cut glass windows**. Even the air is carefully considered and filtered for pollutants and environmental irritants by a cutting-edge **Plasmacluster® air purifier** and **Grape Polyphenol filter**.<sup>1,14</sup>

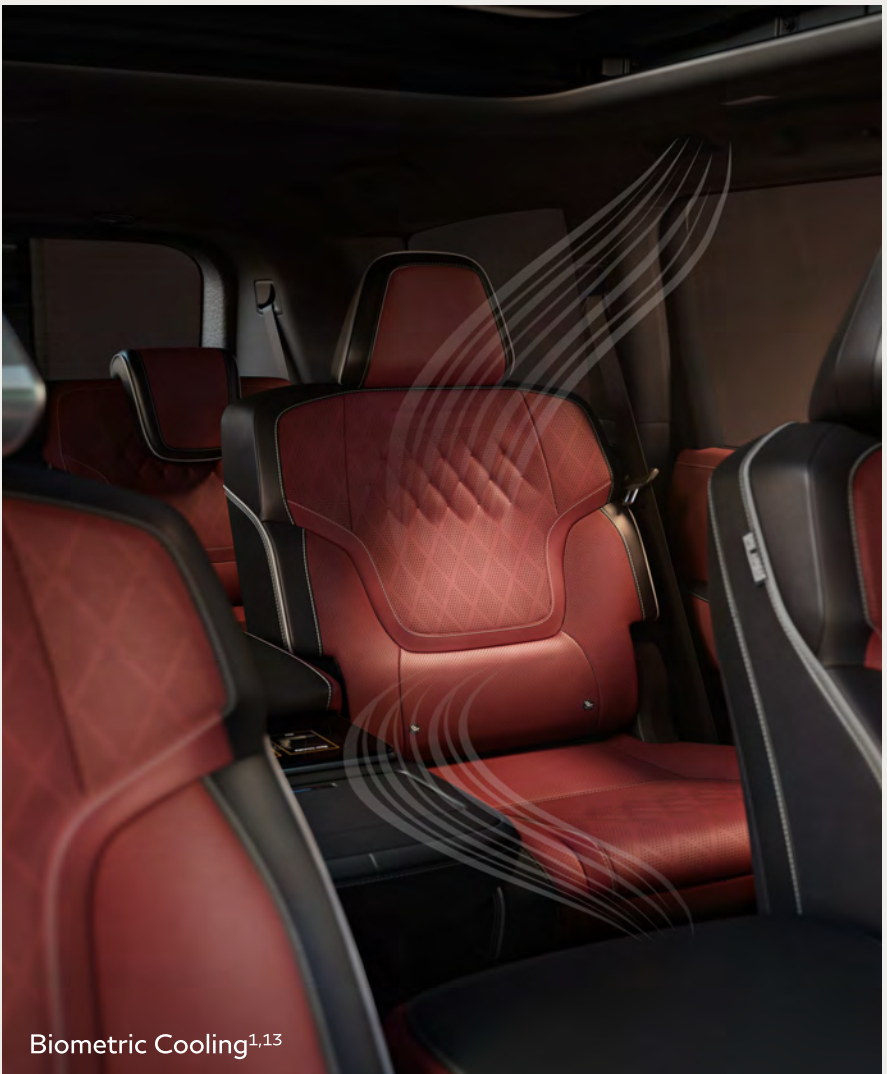
Biometric Cooling<sup>1,13</sup>

## CUTTING-EDGE COMFORT

With available **ventilated and massaging first- and second-row seats** and available **heated seats in all three rows**, QX80 lets all your guests set and achieve their own standard of comfort. The available **Rear Control Panel** with touch-screen functionality and haptic feedback makes accessing these options even more convenient. And with the available front **console cool box**, even small items like seltzer water and chocolate bars have a space to stay cool.

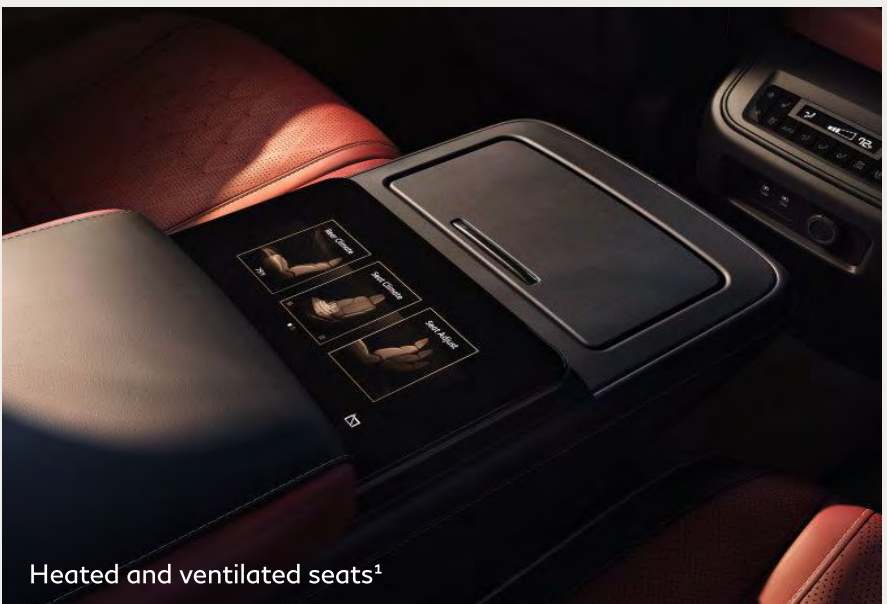

QX80

Personalization Tech

WELCOMING CONVENIENCES

# A Strong Start





## WELCOMING CONVENIENCES

Set the tone for an empowered journey. The **Electronic Air Suspension** can automatically lower your QX80 when it's parked and turned off, so you can step out and load or unload cargo more smoothly.<sup>1,2,15</sup> Make your entrance more comfortable by pre-heating or pre-cooling the cabin with **Remote Engine Start with Climate Control** on your compatible smart device.<sup>6,16</sup>



Electronic Air Suspension<sup>1,15</sup>

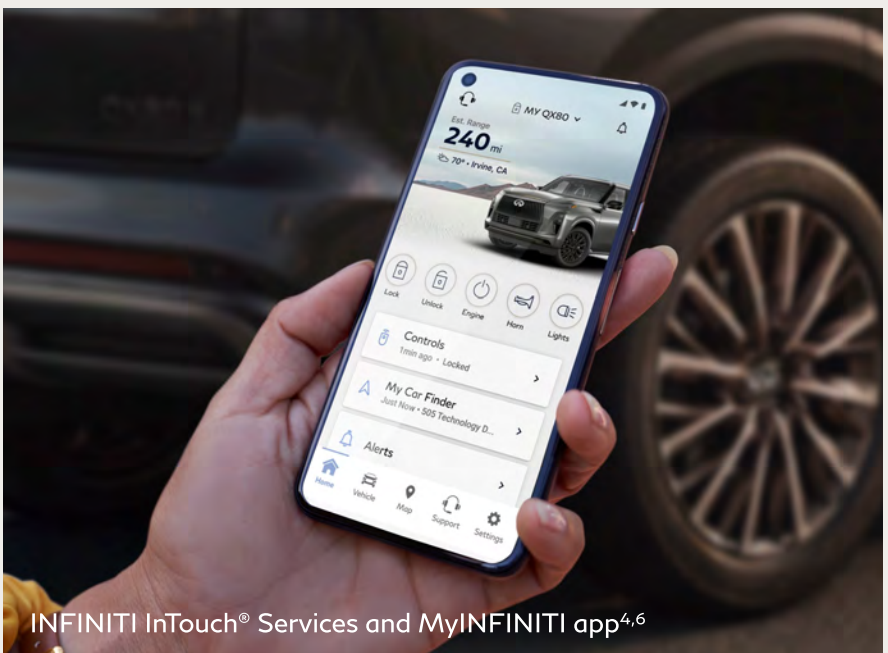

INFINITI InTouch® Services and MyINFINITI app<sup>4,6</sup>

# Drive Tech & Performance

Driver Assist Technology



---

Performance



---

Back to Menu



Build & Price →

QX80

Driver Assist Technology



DRIVER ASSIST FEATURES

# A Relaxed Grip





**DRIVER ASSIST FEATURES**

Reimagine the relationship between driver and vehicle. When activated, standard **ProPILOT Assist 1.1** with **Steering Assist** can maintain your set speed and help you stay centered within a lane and even around gentle curves.<sup>17,18</sup> In traffic, **Intelligent Cruise Control** maintains your distance and brakes when traffic slows – even coming to a complete stop – before re-accelerating when it clears.<sup>1,19</sup>



## DRIVER ASSIST FEATURES

Achieve control in unexpected ways. Available **ProPILOT Assist 2.1** – standard on the AUTOGRAPH trim – can gently assist you into an adjacent open lane and then accelerate to your desired speed. From there, you're free to loosen up as **hands-off driving** helps keep you centered in your lane.<sup>1,20</sup>

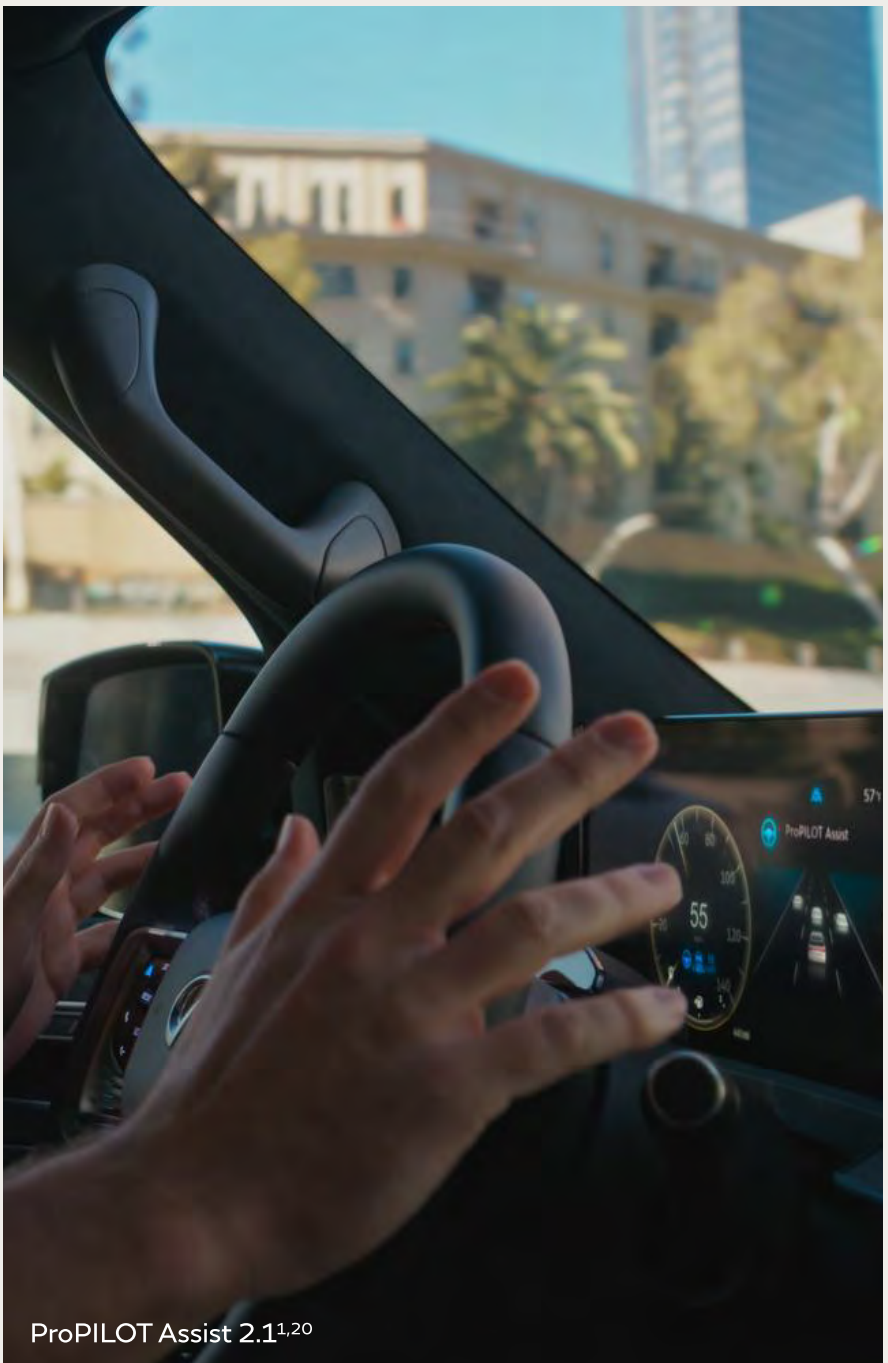

QX80

Driver Assist Technology

VISIBILITY FEATURES

# Optical Solutions





## VISIBILITY FEATURES

The available **Smart RearView Mirror** does more than reflect what's behind you. When your QX80 is full of guests or cargo, simply flip a switch to turn your rearview mirror into a monitor showing the view from the rear cargo door-mounted camera for unobstructed visibility.<sup>2,21</sup>



Smart RearView Mirror<sup>1,21</sup>

## VISIBILITY FEATURES

See through space and time, in full view, on the Dual 14.3" Displays.<sup>4,7</sup> The **170-degree Front Wide View camera** shows you what's around the corner without needing to pull forward. It's almost like glimpsing into the future.<sup>22</sup> Or, if you need to see what's under you, the **Invisible Hood View** lets you peer through the QX80 to spot the curb, the track at the car wash or a runaway soccer ball.<sup>23,24</sup>



170-degree Front Wide View<sup>22</sup>



Invisible Hood View<sup>23</sup>



QX80

Driver Assist Technology

FPO

MANEUVERABILITY FEATURES

Wield With Grace





## MANEUVERABILITY FEATURES

A commanding presence should mean expansion, not limitation. When you need to gauge your clearance, the **3D Around View® Monitor with Moving Object Detection** gives you eight exterior views of the QX80 in one image, which you can rotate 360 degrees with a swipe of your finger on the screen like magic. Or, with the single push of a button, watch as the camera rotates 360 degrees around the vehicle for a quick view of your surroundings. As you maneuver, the system alerts you to motion detected around the vehicle.<sup>24,25</sup>



3D Around View® Monitor featuring Front and Curbside views<sup>24</sup>

**ADDITIONAL DRIVER ASSIST FEATURES**

# Gentle Guidance for the Road Ahead

**PREDICTIVE FORWARD COLLISION WARNING**

Can alert you to a potential collision up to two cars ahead<sup>26</sup>

**FORWARD EMERGENCY BRAKING WITH PEDESTRIAN DETECTION**

Helps watch for vehicles and pedestrians in your path, and if detected, can apply the brakes<sup>27</sup>

**LANE DEPARTURE INTERVENTION**

Constantly monitors lane markings, helping guide you back if you unintentionally begin to drift<sup>28</sup>

**BLIND SPOT INTERVENTION®**

Helps alert the driver to vehicles detected in the blind spot area and actively assists you back toward the center of your lane<sup>29</sup>

**REAR CROSS TRAFFIC ALERT**

Uses sensors when backing up to detect approaching vehicles from either side and alert the driver<sup>30</sup>

**REAR AUTOMATIC BRAKING**

Can help apply the brakes if large stationary objects are detected behind you<sup>31</sup>

QX80

Performance

DYNAMIC DIGITAL SUSPENSION

Go Smoothly





## DYNAMIC DIGITAL SUSPENSION

The QX80 is designed to deliver a smoother ride for everyone aboard, regardless of the road. Designed to help minimize noise, fatigue and motion sickness in extreme driving conditions, the all-new **Dynamic Digital Suspension** dampers work with the **Electronic Air Suspension** springs to intelligently regulate vehicle body behavior, so even life's twists and turns can be navigated in security and comfort. It also lowers the vehicle at cruising speeds for enhanced control and aerodynamics, optimizing for both comfort and performance.<sup>1,15</sup>



Dynamic Digital Suspension<sup>1</sup>



Electronic Air Suspension<sup>1,15</sup>

QX80

Performance

PERFORMANCE CAPABILITIES

# Empowered and Empowering



## PERFORMANCE CAPABILITIES

Power produces both the confidence and the means you need to get there, and QX80 redefines what's possible. The **new 3.5-liter twin-turbo V6 engine** generates up to **450 hp** and **516 lb-ft of torque**, with up to **8,500 lbs maximum towing capacity** (when properly equipped) for a journey empowered from start to finish.<sup>32,33</sup> Traverse intrepidly as **INFINITI All-Mode 4WD®** can automatically adapt to differing road surfaces and driving conditions, or choose the support you need with the **Drive Mode Selector**.<sup>34</sup> And the **E-shifter 9-speed automatic transmission** liberates you to pursue the road ahead in calm control.<sup>35</sup>



3.5-liter twin-turbo V6 engine



# Style & Specs

Style



Specs



Trims



Back to Menu



Build & Price →



Anthracite Gray\*



Mineral Black\*\*,\*\*



Coulis Red\*,\*\*



Radiant White\*,\*\*



Grand Blue\*,\*\*



Dynamic Metal\*,\*\*



Black Obsidian

INFINITI has taken care to ensure that the digital color swatches presented here are the closest possible representation of actual vehicle colors. Swatches may vary slightly due to viewing light or screen quality. Please see the actual vehicle and colors at your retailer. \*Extra cost option. \*\* Two-tone exterior paint is only available on AUTOGRAPH trim.

INTERIORS 1 OF 3



Graphite TailorFit® Leatherette (PURE)



Tuscan Beige TailorFit® Leatherette (PURE)



Graphite Leather Appointments (LUXE)

INFINITI has taken care to ensure that the digital color swatches presented here are the closest possible representation of actual vehicle colors. Swatches may vary slightly due to viewing light or screen quality. Please see the actual vehicle and colors at your retailer.



INTERIORS 2 OF 3



Sepia Brown Leather Appointments (LUXE)



Graphite Semi-aniline Leather Appointments (SENSORY)



Sepia Brown Semi-aniline Leather Appointments (SENSORY)

INFINITI has taken care to ensure that the digital color swatches presented here are the closest possible representation of actual vehicle colors. Swatches may vary slightly due to viewing light or screen quality. Please see the actual vehicle and colors at your retailer.

INTERIORS 3 OF 3



Graphite Semi-aniline Leather Appointments (AUTOGRAPH)



Burgundy Semi-aniline Leather Appointments (AUTOGRAPH)

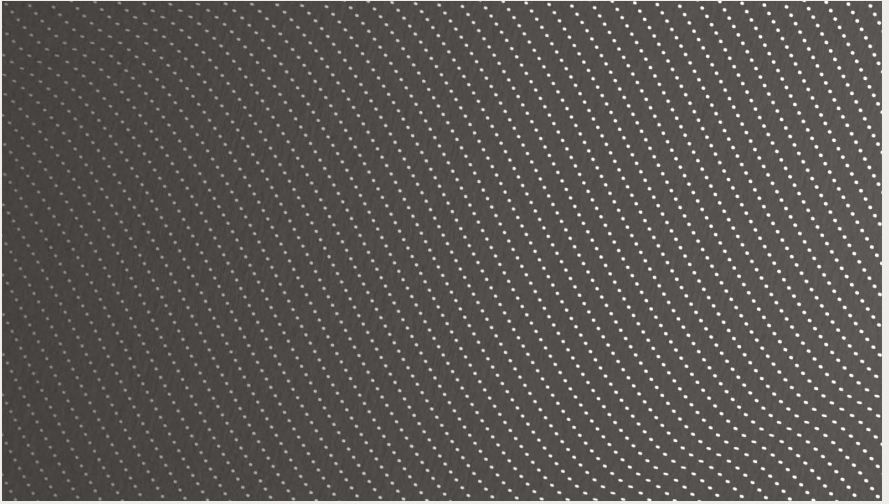

Black Aluminum (PURE / LUXE)



Open Pore Ash Wood (SENSORY)

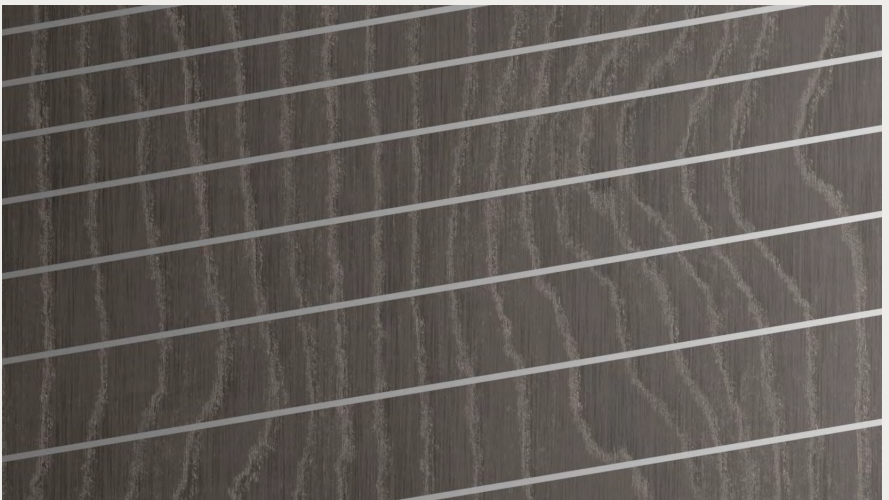

Open Pore Ash Wood with Metal Inlay (AUTOGRAPH)





20-inch aluminum-alloy wheels (PURE)



22-inch aluminum-alloy wheels (LUXE / SENSORY)



22-inch aluminum-alloy wheels (AUTOGRAPH)

---

**INTERIOR DIMENSIONS**

---

Head room – first row / second row / third row (inches)  
39.1 / 37.8 / 36.2

---

Leg room – first row / second row / third row (inches)  
43.8 / 39.2 / 32.9

---

**CAPACITIES**

---

Seating  
7 or 8 passengers

---

Cargo volume<sup>2</sup> – 2nd and 3rd row folded flat (cu. ft.)  
101

---

Maximum tow capacity<sup>33</sup>  
8,500 lbs

---

Fuel tank  
23.6 gallons

**POWER & FUEL ECONOMY**

---

Horsepower

450 hp @ 5,600 rpm<sup>32</sup>

---

Torque

516 lb-ft @ 3,600 rpm<sup>32</sup>

---

Estimated fuel economy 2WD<sup>35</sup> – city / highway /  
combined (MPG)

16 / 20 / 18

---

Estimated fuel economy 4WD<sup>35</sup> – city / highway /  
combined (MPG)

16 / 19 / 17



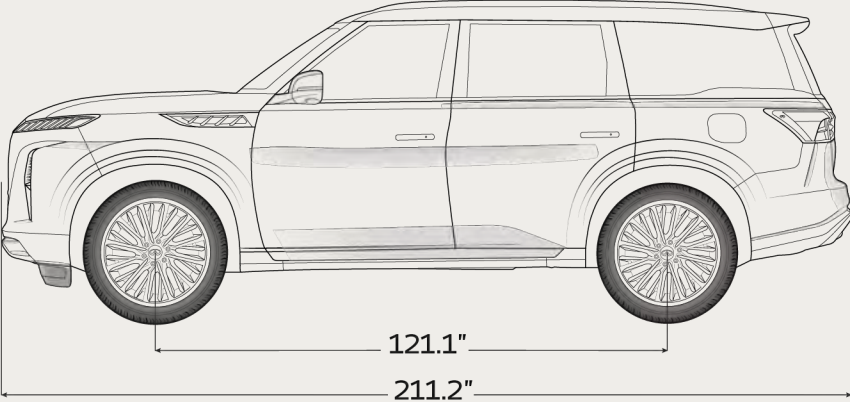
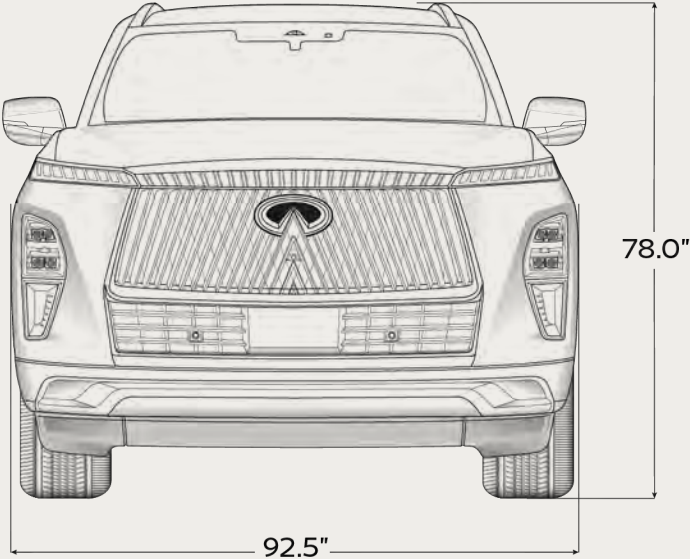

All dimensions are measured in inches.



**QX80 PURE**

The All-New 2025 QX80



**QX80 LUXE**

Additional Comfort and Convenience Features



**QX80 SENSORY**

Where Technology and Comfort Converge



**QX80 AUTOGRAPH**

For The Consummate Host



QX80

# PURE



Build & Price →





**PURE 1 OF 7****MECHANICAL & PERFORMANCE**

---

3.5L twin-turbo V6 engine (450 hp, 516 lb-ft of torque)<sup>32</sup>

---

9-speed automatic transmission with manual shift mode

---

Paddle shifters

---

Rear-Wheel Drive or INFINITI All-Mode 4WD<sup>®34</sup>

---

Drive Mode Selector

---

13.78-inch front/rear ventilated disc brakes

---

Independent double-wishbone front/rear suspension

---

Electric Power Steering

---

Integrated Class IV tow hitch and 7-pin wiring harness<sup>36</sup>

---

**EXTERIOR**

---

20-inch aluminum-alloy wheels with 275/60R20 all-season tires

---

LED automatic on/off headlights

---

LED signature Daytime Running Lights

---

INFINITI Radiant<sup>®</sup> Grille Emblem

**PURE 2 OF 7**

---

Panoramic moonroof

---

Acoustic laminated glass (windshield and front side)

---

UV and IR cut glass (side and rear windows)

---

Rear privacy glass

---

Power folding, heated outside mirrors with integrated turn signals, puddle lamps and reverse sync

---

Auto-dimming driver-side outside mirror

---

Flush Door Handles

---

Roof rails<sup>2</sup>

---

Running boards

---

**COMFORT & CONVENIENCE**

---

TailorFit<sup>®</sup> leatherette seating

---

Leather-wrapped steering wheel

---

Black Aluminum interior trim accents

---

10-way power front seats including 2-way lumbar support

---

Second-row fold-down captain's chairs with one-touch release for easy third-row entry/exit

**PURE 3 OF 7**

---

Third-row 60:40-split fold-down bench seat with power recline and one-touch folding<sup>37</sup>

---

Power tilting and telescoping steering column

---

2-driver memory system for driver's seat steering wheel and outside mirrors

---

Tri-Zone Automatic Temperature Control System with microfilter

---

Heated front and second-row seats

---

Heated steering wheel

---

Intelligent Key with push button ignition

---

Remote Engine Start<sup>16</sup>

---

Approach unlock & walk away lock

---

Frameless auto-dimming rearview mirror

---

Rain-sensing front windshield wipers

---

Motion-Activated Liftgate

---

**INFOTAINMENT**

---

INFINITI 14.3-inch Dynamic Meter Display<sup>7</sup>

---

INFINITI InTouch® 14.3-inch Interactive Display<sup>4</sup>



**PURE 4 OF 7**

---

9-inch front touch-screen control panel with haptic feedback

---

INFINITI InTouch® Services with 5-year trial access to Select and 3-year trial access to Premium packages<sup>4</sup>

---

In-Vehicle Data and Wi-Fi with 3-month or 3GB trial subscription<sup>4,38</sup>

---

Google built-in<sup>4,11</sup>

---

Alexa Built-in<sup>4,39</sup>

---

Hybrid Radio<sup>4,38</sup>

---

Wireless Apple CarPlay® integration<sup>4</sup>

---

Wireless Android Auto™ compatibility<sup>4</sup>

---

Bluetooth® Hands-free Phone System with audio streaming<sup>4</sup>

---

Connected garage door opener with myQ®

---

SiriusXM® with 360L with 3-month subscription included<sup>4,40</sup>

---

Klipsch® Premium Audio System with 14 speakers

---

DJX® 2D Surround technology

---

Active Sound Enhancement

---

**PURE 5 OF 7**

---

8 USB-C ports<sup>6</sup>

---

Wireless charging pad<sup>6</sup>

---

**DRIVER ASSISTANCE**

---

ProPILOT Assist 1.1<sup>17</sup>

---

Predictive Forward Collision Warning<sup>26</sup>

---

Forward Emergency Braking with Pedestrian Detection<sup>27</sup>

---

Lane Departure Warning<sup>28</sup>

---

Lane Departure Prevention<sup>28</sup>

---

Blind Spot Warning<sup>29</sup>

---

Blind Spot Intervention<sup>®29</sup>

---

Rear Cross Traffic Alert<sup>30</sup>

---

Rear Automatic Braking<sup>31</sup>

---

Front and Rear Sonar System<sup>41</sup>

---

3D Around View<sup>®</sup> Monitor with Moving Object Detection<sup>24</sup>

---

Smart RearView Mirror<sup>21</sup>

---

Hill start assist

**PURE 6 OF 7**

---

Trailer sway control<sup>36</sup>

---

Electronic parking brake with automatic brake hold

---

High Beam Assist

---

Traffic Sign Recognition<sup>42</sup>

---

Driver Attention Alert<sup>43</sup>

**SAFETY**

---

INFINITI Advanced Air Bag System includes dual-stage front air bags with seat belt sensors and an occupant-classification sensor<sup>44</sup>

---

Driver and front-passenger supplemental knee air bags<sup>44</sup>

---

Driver and front-passenger seat-mounted side-impact supplemental air bags<sup>44</sup>

---

Roof-mounted curtain supplemental air bags for side-impact and rollover head protection for outboard occupants<sup>44</sup>

---

LATCH System (Lower Anchors and Tethers for Children)

---

Zone Body construction with front and rear crumple zones

---

Tire Pressure Monitoring System with Easy-Fill Tire Alert<sup>45,46</sup>



**PURE 7 OF 7****AVAILABLE OPTION 1****1 SPLIT-BENCH SEAT PACKAGE**

---

Second-row 40:20:40-split folding bench seat

---

Center armrest with two cup holders  
(replaces second-row captain's chairs)

QX80

# LUXE



Build & Price →



**LUXE 1 OF 2**

Includes All QX80 PURE Standard Features, Plus:

**MECHANICAL & PERFORMANCE**

---

Electronic Air Suspension springs<sup>15</sup>

---

Dynamic Digital Suspension dampers

**EXTERIOR**

---

22-inch aluminum-alloy wheels with 275/50R22 all-season tires

**COMFORT & CONVENIENCE**

---

Leather-appointed seats (first and second rows)

---

12-way power front seats including 4-way lumbar support

---

Second-row power slide/recline seats with remote fold down<sup>37,47</sup>

---

Climate-controlled first and second-row seats

**INFOTAINMENT**

---

Head-Up Display<sup>8</sup>

**LUXE 2 OF 2****AVAILABLE OPTIONS** **1** **2** **3****1 PROPILOT ASSIST 2.1**

---

ProPILOT Assist 2.1 featuring Intelligent Cruise Control with full-speed range, stop & hold and auto-resume, Steering Assist, Lane Change Assist, Passing Assist and hands-off driving<sup>18,19,20</sup>

---

Personalized Ambient Lighting (64-color)

**2 SPLIT-BENCH SEAT PACKAGE**

---

Second-row 40:20:40-split folding bench seat

---

Center armrest with two cup holders  
(replaces second-row captain's chairs)

**3 INFINITI RADIANT ILLUMINATED KICK PLATES**

---

INFINITI Radiant Silver Illuminated Kick Plates for front and rear doors



QX80

# SENSORY



Build & Price →



**SENSORY 2 OF 2**

---

120-volt AC power outlet<sup>6,48</sup>

**INFOTAINMENT**

---

INFINITI Dash Cam Recorder<sup>10</sup>

---

Klipsch Reference Premiere™ Audio System with 24 speakers

---

DJX® 3D Surround technology

---

DynamicAudioReveal™ noise compensation

---

Individual Audio<sup>5</sup>

**AVAILABLE OPTIONS** **1** **2****1 PROPILOT ASSIST 2.1**

---

ProPILOT Assist 2.1 featuring Intelligent Cruise Control with full-speed range, stop & hold and auto-resume, Steering Assist, Lane Change Assist, Passing Assist and hands-off highway driving<sup>18,19,20</sup>

---

Personalized Ambient Lighting (64-color)

**2 SPLIT-BENCH SEAT PACKAGE**

---

Second-row 40:20:40-split folding bench seat

---

Center armrest with two cup holders (replaces second-row captain's chairs)

---

**SENSORY 1 OF 2**

Includes All QX80 LUXE Standard Features, Plus:  
**MECHANICAL & PERFORMANCE**

---

INFINITI All-Mode 4WD<sup>®34</sup>

**EXTERIOR**

---

INFINITI Light Path

---

Auto-dimming passenger-side outside mirror

**COMFORT & CONVENIENCE**

---

Semi-aniline leather-appointed seating (first and second rows)

---

Premium leather-wrapped steering wheel

---

Open Pore Ash Wood interior trim accents

---

Personalized Ambient Lighting (64-color)

---

INFINITI Radiant Kick Plates

---

Dual occupant memory system for passenger's seat

---

Advanced Climate Control System with auto-recirculation, Plasmacluster<sup>®</sup> air purifier and Grape Polyphenol filter<sup>14</sup>

---

Biometric Cooling<sup>13</sup>

---

Massaging front seats

QX80

# AUTOGRAPH



Build & Price →





**AUTOGRAPH 1 OF 2**

Includes All QX80 SENSORY Standard Features,  
Plus:

**EXTERIOR**

---

22-inch AUTOGRAPH aluminum-alloy wheels with  
275/50R22 all-season tires

---

Two-tone exterior roof

---

Black exterior mirror caps

---

Dark chrome exterior trim

**COMFORT & CONVENIENCE**

---

Dot-quilted semi-aniline leather-appointed seating

---

Open Pore Ash Wood with Metal Inlay interior trim  
accents

---

Graphite Suede headliner and pillars

---

Second-row massaging seats with 4-way power  
lumbar support

---

Heated third-row seats

---

Front console cool box

---

Windshield wiper deicer

**AUTOGRAPH 2 OF 2****INFOTAINMENT**

---

In-car camera with Remote View

---

9-inch rear touch-screen control panel

**DRIVER ASSISTANCE**

---

ProPILOT Assist 2.1<sup>20</sup>

**SAFETY**

---

Driver seat-mounted front-center supplemental air bag<sup>44</sup>

# Accessories

Exterior 

---

Interior 

---

Cargo 

---

Towing 

---

Lighting & Tech 

---

Pet 

---

Back to Menu 

Build & Price →

QX80

Exterior Accessories



EXTERIOR ACCESSORIES

Refine Your  
Presence





**EXTERIOR ACCESSORIES**

Refine your presence with the **22" INFINITI Performance Black Monogram Wheel** or the **22" INFINITI Performance Machined Finish Monogram Wheel** so you can roll in with style. The transparent design of the **Clear Hood Protector** provides protection without sacrificing style.



22" INFINITI Performance Machined Finish Monogram Wheels



Clear Hood Protector

**EXTERIOR ACCESSORIES**

Protect your bumper from dings and scratches while enhancing the appearance of your QX80 with a **Matte Chrome Rear Bumper Protector**. The **Silver Roof Rail Crossbars** integrate with various Affiliated: Yakima® roof rack accessories to maximize your utility.<sup>2,49</sup>



Matte Chrome Rear Bumper Protector

Silver Roof Rail Crossbars<sup>2</sup>



QX80

Interior Accessories

INTERIOR ACCESSORIES

Prepared for  
Every Day and  
Every Adventure

QX80



BACK TO SECTION

**INTERIOR ACCESSORIES**

**All-Season Floor Mats - High Wall Liners** are custom-made of a durable and long-wearing material to help keep your QX80 clear of mud, slush and debris. The **Umbrella Holder** mounts under the front of the driver or passenger seat for convenient access to your **INFINITI Compact Umbrella**, while the **Console Net** provides a versatile, lightweight solution to securing your everyday items.

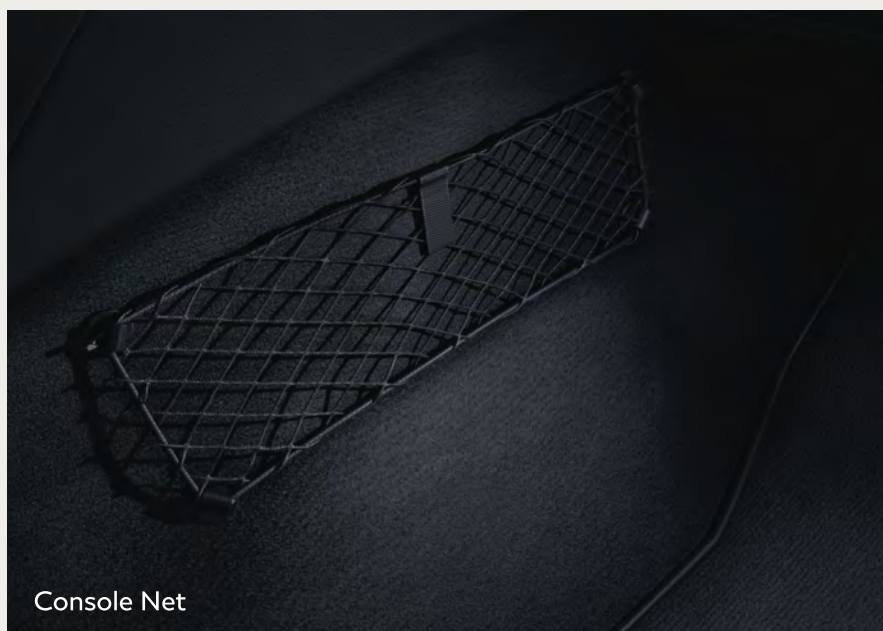
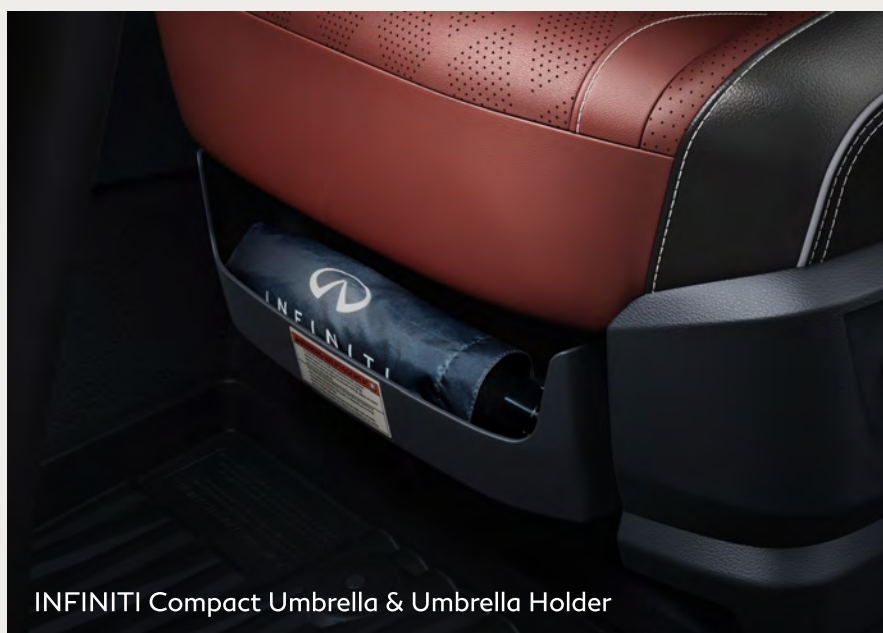



**INTERIOR ACCESSORIES**

Take your organization further with a **Seatback Organizer** that is designed to fit over the back of the front passenger seat. Keep your QX80 clean and kempt with a **Trash Bin** featuring a stylish design that works to complement your vehicle's interior.

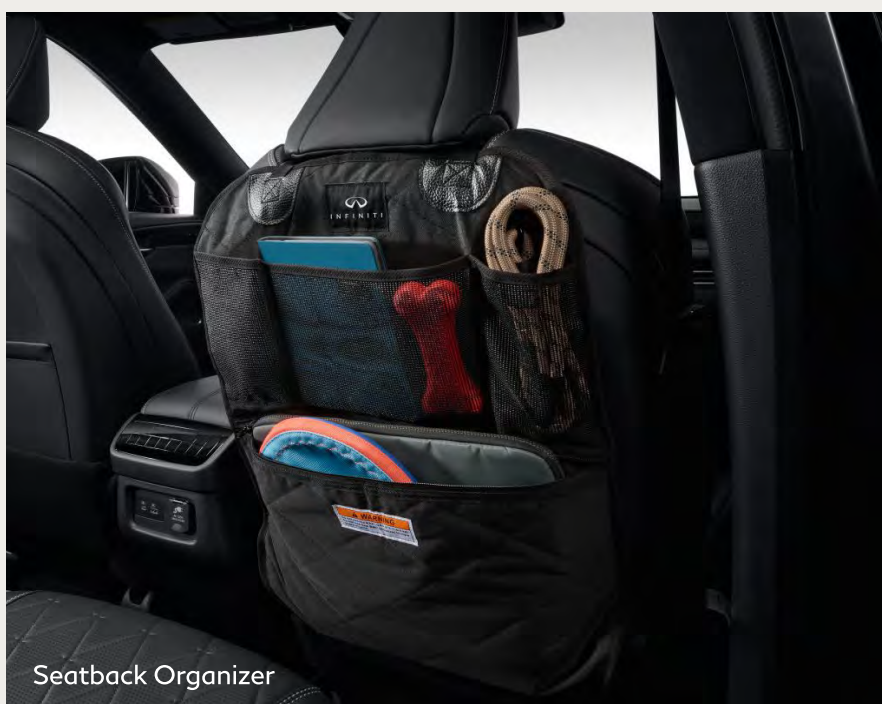

Seatback Organizer



Trash Bin

QX80

Cargo Accessories



CARGO ACCESSORIES

Excursion Awaits





**CARGO ACCESSORIES**

Flex your flexibility with a **Cargo Shelf/Barrier**, which functions as a luggage board when positioned horizontally or as a cargo area divider when positioned vertically. Add a **Soft Sided Cargo Cooler** to keep your food and drinks cool for up to 30 hours on your next outing with its insulated, leakproof interior and sleek carbon fiber patterned vinyl exterior.<sup>2</sup>



Cargo Shelf/Barrier



Soft Sided Cargo Cooler

**CARGO ACCESSORIES**

Keep items secure with a set of interlocking **Cargo Blocks/Stabilizers**, which can securely connect to the **Carpeted Cargo Area Protector** to hold various sizes of cargo in place. And when your roaming takes you far, a **Hatch Tent (10' x 10')** converts your cargo area into a sleeping area.<sup>2</sup>



Cargo Blocks/Stabilizers and Carpeted Cargo Area Protector



Hatch Tent (10' x 10')



**CARGO ACCESSORIES**

Haul your gear smoothly and in style with the **Affiliated: Yakima® SkyBox 16 – Roof Cargo Box**, featuring a sleek, aerodynamic Carbonite textured lid and a dual-sided opening for easy access on either side of your vehicle. Visiting the mountains? The **Affiliated: Yakima® HitchSki – Hitch Mount Ski Adapter** holds and locks up to six pairs of snow skis or four snowboards with soft, flexible rubber padding to protect gear.<sup>2,49</sup>



Affiliated: Yakima® SkyBox 16 – Roof Cargo Box<sup>2,49</sup>



Affiliated: Yakima® HitchSki – Hitch Mount Ski Adapter<sup>2,49</sup>

QX80

Towing Accessories

TOWING ACCESSORIES

# Possibility in Tow





**TOWING ACCESSORIES**

Go big on what you can bring. With a **Hitch Ball Mount - Class III** and **Hitch Ball - Class III (2" Coupler)**, QX80 is ready to tow your toys.<sup>36,50</sup>



Hitch Ball Mount - Class III and Hitch Ball - Class III (2" Coupler)<sup>36,50</sup>

# QX80 Lighting & Tech Accessories



LIGHTING & TECH ACCESSORIES

# That Futuristic Feeling





# QX80 Lighting & Tech Accessories

## LIGHTING & TECH ACCESSORIES

Cultivate ambience with a **Panoramic Illuminated Headliner**. Hidden white LEDs illuminate the headliner area around the panoramic moonroof for a mood with a little bit of magic. When someone's device needs power, reach for a **USB Charging Cable Set**, complete with Lightning® and USB-C connectors for connecting to Apple® and Android™ devices.<sup>6</sup>



Panoramic Illuminated Headliner



USB Charging Cable Set<sup>6</sup>

# QX80 Lighting & Tech Accessories

## LIGHTING & TECH ACCESSORIES

Add a touch of style to every entrance with a soft-glowing INFINITI logo along the bottom of all four door sills powered by **INFINITI Radiant Silver Illuminated Kick Plates**.



INFINITI Radiant Silver Illuminated Kick Plates

# QX80 Lighting & Tech Accessories

## LIGHTING & TECH ACCESSORIES

Lock and unlock doors and start your QX80, all without a key, through **Virtual Key** on your compatible smartphone or watch.<sup>6,16,51</sup>

Available in Black for AUTOGRAPH or Silver for all other trims, **INFINITI Radiant® Illuminated Cargo Scuff Plates** are designed to protect against scratches and scuffs when loading cargo while also enhancing your style. The **Rear Camera Dryer** operates automatically when using reverse gear to help keep the rear camera free from water drops.



INFINITI Radiant Black Illuminated Cargo Scuff Plates



Rear Camera Dryer



QX80

Pet Accessories



PET ACCESSORIES

Room for the  
Whole Family





**PET ACCESSORIES**

Bring your furry friends along for the adventure. The telescoping **Pet Ramp** expands to 64 inches to help your pups get in and out of the vehicle, and the folding **Pet Carrier** includes three mesh doors (top, side and front) with zipper closures. Available in four sizes, from Small to X-Large, the **Dog Harness** includes a tether strap that secures the harness to a rear-seat buckle to help prevent your dog from exiting the side door when you open it.



Pet Carrier



Dog Harness



## INFINITI PREMIUM CARE

# Drive With Confidence

Keeping your INFINITI properly maintained keeps it thoroughly rewarding. That's why the INFINITI Premium Care maintenance program exists to help sustain confidence in your drive. For each 2022–2025 INFINITI vehicle, INFINITI Premium Care gives you peace of mind in a constantly changing world with 36 months or your vehicle's designated mileage coverage (whichever occurs first) of routine maintenance, including: oil changes, tire rotations, brake fluid replacement, in-cabin microfilter replacement, engine air filter and Tire Road Hazard Protection (not available in Florida).<sup>52</sup> Factory-trained technicians use Genuine INFINITI parts to ensure the utmost care, quality and performance. For more information, please visit your local retailer.<sup>53</sup>





# The Journey Begins

Build an INFINITI that's tailored to your taste and designed around your life.

Build your QX80 →



JOIN OUR COMMUNITY





- 1 Available feature.
- 2 Cargo shown for display purposes only. Cargo and load capacity limited by weight and distribution. Always secure cargo. Heavy loading of the vehicle with cargo, especially on the roof, will affect the handling and stability of the vehicle.
- 3 When operating the rear power-seatback return, make sure that the vehicle is stopped and the transmission is in the P (Park) position.
- 4 Feature availability is dependent on vehicle model, trim level, packaging and options. Trial included with vehicle purchase. **Consumer activation of INFINITI InTouch Services package required.** Compatible connected device and wireless network may be required. Refer to connected device's owner's manual for details. Late availability for some features.
- Driving is serious business and requires your full attention. Only use features and connected devices when safe and legal to do so. Some features, including automatic crash notification and SOS, are dependent upon the telematics device being in operative condition, its ability to connect to a wireless network, compatible wireless network availability, navigation map data and GPS satellite signal reception, the absence of which can limit or prevent the ability to reach Customer Care or receive support. GPS mapping may not be detailed in all areas or reflect current road status. Never program GPS while driving. Only use Remote Engine Start and Remote Horn features in accordance with any laws, rules or ordinances in effect in your vehicle's location. **Cellular network not available in Guam, Puerto Rico, U.S. Virgin Islands, Saipan or American Samoa.**
- Some services and features are provided by and dependent on third party service providers and not INFINITI. **Should service providers terminate or restrict service or features, service or features may be suspended or terminated without notice or with no liability to INFINITI or its partners or agents.** Services and features may require compatible cellular network provided by independent companies not within INFINITI or its partners' or agents' control. Cellular network signal strength may vary and may not be available in all areas or at all times. Services and features may not function if cellular network is unavailable, restricted, or terminated. INFINITI and its partners or agents are not responsible for associated costs or other third-party charges that may be required for continued operation due to cellular network unavailability, restriction, or termination (including equipment replacements/upgrades, if available, or roaming charges on alternative networks). Technology is evolving, and changes by independent companies are not within INFINITI's or its partners' or agents' control.
- Enrollment, owner consent, personal identification number (PIN), and subscription agreement may be required to receive full suite of features and services. Trial periods (if applicable) begin on the date of vehicle purchase or lease of a new INFINITI. Trial periods and feature availability may be subject to change at any time and may be subject to early termination without notice. Required subscriptions may be sold separately for each available feature or service after trial period ends, and may continue until you call service provider to cancel. Installation costs, one-time activation fee, other fees and taxes may apply. Fees and programming subject to change. Feature may be subject to age restrictions in some areas. Subscriptions governed by service provider's subscription agreement, terms and conditions and privacy statements available at service provider's website. Text rates or data usage may apply. INFINITI InTouch® with Wi-Fi terms and conditions of subscriber agreement apply. Trial is included with vehicle purchase on equipped new INFINITI vehicles. Once your vehicle has exceeded the coverage parameters of the roadside assistance benefits included with your vehicle purchase, you will be responsible for any charges incurred by obtaining roadside assistance for your vehicle. For complete information concerning warranty coverage, conditions and exclusions, please see your INFINITI dealer and read the warranty information booklet.
- The INFINITI names, logos and slogans are trademarks owned by or licensed to Nissan Motor Co. Ltd. or its North American subsidiaries. Other trademarks and trade names are those of their respective owners.
- For important safety information, system limitations, and additional operating and feature information, see dealer, owner's manual, or [www.infiniti-usa.com/intouch/legal.html](http://www.infiniti-usa.com/intouch/legal.html).
- 5 Available feature. Individual Audio is intended to isolate select audio sources for listening to INFINITI Owners, and cannot buffer interior sound. Please see INFINITI Owner's Manual for full details and information before using.
- 6 Driving is serious business and requires your full attention. If you have to use the connected device while driving, exercise extreme caution at all times so full attention may be given to vehicle operation. External device not included.
- 7 Information displayed is dependent on how vehicle is equipped. Driving is serious business and requires your full attention. If you have to use the feature while driving, exercise extreme caution at all time so full attention may be given to vehicle operation.
- 8 Information displayed is dependent on how vehicle is equipped. Do not use for extended periods of time. See Owner's Manual for important safety information.
- 9 Never program while driving. GPS mapping may not be detailed in all areas or reflect current road status.
- 10 INFINITI Dash Cam Recorder to be used only in accordance with any laws or rules in effect in your vehicle's location that may apply to audio or video recordings of drivers and passengers. Not every impact will trigger the vehicle's sensors and, as a result, may not activate some or all the vehicle's cameras.
- 11 Feature availability varies by vehicle model year, model, trim level, packaging and options. **Consumer activation of INFINITI InTouch Services SELECT package ("Package") required.** Package trial period included with eligible new vehicle purchase or lease. Trial period may be subject to change or termination at any time and without notice. After trial period ends, monthly subscription fee required. Driving is serious business and requires your full attention. Only use features when safe and legal to do so. Never program while driving. GPS mapping may not be detailed in all areas or reflect current road status. Connectivity service required. App subscriptions may be required. Data rates may apply. Subject to third party service availability. Should such service providers terminate or restrict service or features, service or features may be suspended or terminated without notice or with no liability to INFINITI or its partners or agents. Google, Google Play and Google Maps are trademarks of Google LLC. For more information, see [www.infiniti-usa.com/intouch/legal](http://www.infiniti-usa.com/intouch/legal).
- 12 Use Hands Free Text Messaging when parked in a safe location. If you must use while driving, monitor traffic conditions and keep both hands on the steering wheel to prevent collisions. Compatible device required. Message and data rates may apply.
- 13 System may not engage if sensor is obstructed. System does not have the capability to identify individual passengers. Please see INFINITI Owner's Manual for feature information.
- 14 The Advanced Climate Control System with Plasmacluster® air purifier helps scrub the air in the vehicle's interior. The system senses exterior odors, suppresses unpleasant interior odors, stops the inflow of external odors and helps keep the cabin smelling fresh, but does not always eliminate odors.
- 15 Available feature. Lowering and raising action for Access mode can only be performed when vehicle is at a complete stop and parked. Please see INFINITI Owner's Manual for full details and information before using.
- 16 Remote Engine Start to be used only in accordance with laws or rules in effect in your vehicle's location.
- 17 ProPILOT Assist 1.1 cannot prevent collisions. It is the driver's responsibility to be in control of the vehicle at all times. Always monitor traffic conditions and keep both hands on the steering wheel. System operates only when lane markings are detected. Does not function in all weather, traffic and road conditions. System has limited control capability and the driver may need to steer, brake or accelerate at any time to maintain safety. See Owner's Manual for safety information.
- 18 See owner's manual for safety information and system limitations.
- 19 Intelligent Cruise Control uses limited braking and is not a collision avoidance or warning system. Driver should monitor traffic conditions and brake as needed to prevent collisions. See Owner's Manual for safety information.
- 20 Consumer activation of INFINITI InTouch Services ProPILOT Assist 2.1 package ("Package") required for ProPILOT Assist 2.1 functionality. Package trial period included with new vehicle purchase. Trial period may be subject to change or termination at any time and without notice. After trial period ends, monthly subscription fee required. See [www.infiniti-usa.com/intouch/legal](http://www.infiniti-usa.com/intouch/legal) for more subscription information. ProPILOT Assist 2.1 cannot prevent collisions. It is the driver's responsibility to be in control of the vehicle and monitor traffic conditions at all times. Hands-off freeway driving is possible when driving in a single lane, on the condition that the driver remains attentive on the road ahead and is prepared to immediately take manual control of the steering wheel when conditions of the road, traffic, and vehicle require it. System operates only when lane markings are detected. Does not function in all weather, traffic and road conditions. System has limited control capability and the driver may need to steer, brake or accelerate at any time to maintain safety. See Owner's Manual for safety information.
- 21 Smart RearView Mirror may not detect every object and does not eliminate blind spots or warn of moving objects. See Owner's Manual for safety information.
- 22 Front Wide View cannot eliminate blind spots and does not warn of moving objects. Driver should always check surroundings before driving. See Owner's Manual for safety information.
- 23 Invisible Hood View cannot eliminate blind spots and does not warn of moving objects. Driver should always check surroundings before driving. See Owner's Manual for safety information.
- 24 3D Around View Monitor with Moving Object Detection cannot eliminate blind spots and may not detect every object. Driver should always turn and check surroundings before driving. See Owner's Manual for safety information.
- 25 Virtual composite 360° view.
- 26 Predictive Forward Collision Warning cannot prevent collisions. See Owner's Manual for safety information.
- 27 Forward Emergency Braking with Pedestrian Detection cannot prevent all collisions and may not provide warning or braking in all conditions. Driver should monitor traffic conditions and brake as needed to prevent collisions. See Owner's Manual for safety information.
- 28 Lane Departure Prevention and Lane Departure Warning only operates when lane markings or road edge (if equipped) are detectable. See Owner's Manual for safety information.
- 29 Blind Spot Intervention and Blind Spot Warning cannot prevent all collisions and may not detect every object or warn in all situations. Driver should always turn and look before changing lanes. See Owner's Manual for safety information.
- 30 Rear Cross Traffic Alert may not detect all vehicles. See Owner's Manual for safety information.
- 31 Rear Automatic Braking cannot prevent all collisions and may not provide warning or braking in all conditions. Driver should always turn and check surroundings before driving and brake as needed to prevent collisions. See Owner's Manual for safety information.
- 32 Horsepower and torque figures based on premium fuel only.
- 33 Up to 8,500 lbs towing for 2025 QX80. Towing capacity varies by configuration. See INFINITI Towing Guide and Owner's Manual for additional information. Cargo and load capacity limited by weight and distribution. Always secure cargo.
- 34 INFINITI All-Mode 4WD® cannot prevent collisions or provide enhanced traction in all conditions. Always monitor traffic and weather conditions.
- 35 2025 EPA Fuel Economy Estimates 16 City/20 Highway/18 Combined for QX80 2WD; 16 City/19 Highway/17 Combined for QX80 4WD. Actual mileage may vary with driving conditions. Use for comparison only.
- 36 Towing capacity varies by configuration. See INFINITI Towing Guide and Owner's Manual for additional information. Always secure cargo.
- 37 Do not ride in a moving vehicle when the seatback is reclined. For the most effective protection, the seat should be upright. See Owner's Manual for safety information.
- 38 INFINITI vehicle with AT&T-compatible in-vehicle Wi-Fi hotspot capability:** 3-GB or 90-Day (whichever occurs first) AT&T in-vehicle Wi-Fi trial subscription ("**AT&T in-vehicle Wi-Fi Hotspot Trial**") is included with the purchase or lease of a new INFINITI vehicle if: (i) vehicle is equipped with compatible SIM, and (ii) customer activates AT&T in-vehicle Wi-Fi Trial ("Trial Activation"). Data charges may apply. Trial period begins at time of customer's Trial Activation. Trial ends when all data is used or period ends, whichever comes first. Trial does not renew. To continue service following expiration of the trial period, purchase of an AT&T subscription is required. **This feature is not intended for use by the driver while the vehicle is in motion. Always drive safely. AT&T in-vehicle Wi-Fi Trial is owned and operated by AT&T, use of AT&T account and its services and features are subject to the AT&T Consumer Service Agreement and Privacy Policy, and are not within Nissan's control. Other restrictions apply. Visit [www.att.com/csa](http://www.att.com/csa) for complete terms and conditions.** Should AT&T terminate, change, or restrict service or features, service or features may be suspended or terminated without notice or with no liability to INFINITI or its partners or agents. INFINITI and its partners or agents are also not responsible for associated costs or other third party charges that may be required for continued operation due to cellular network unavailability, restriction, or termination (including equipment replacements/upgrades, if available, or roaming charges on alternative networks). Trial subscription is subject to change or early termination at any time without notice. AT&T, AT&T logo and all other marks contained herein are trademarks of AT&T Intellectual Property and/or AT&T affiliated companies. The INFINITI names, logos and slogans are trademarks owned by or licensed to INFINITI Motor Co. Ltd. and/or its North American subsidiaries. Other trademarks and trade names are those of their respective owners.
- 39 Feature availability varies by vehicle model year, model, trim level, packaging and options. Connectivity service may be required. Alexa is Amazon's cloud-based voice service. Subject to third party service availability. Amazon, Alexa, Echo, and all related marks are trademarks of Amazon.com, Inc. or its affiliates. For more information see [www.infiniti-usa.com/intouch/legal](http://www.infiniti-usa.com/intouch/legal).
- 40 INFINITI vehicle with "SiriusXM with 360L" capability: SiriusXM with 360L trial period is included with the purchase or lease of a new INFINITI vehicle if: (i) vehicle is equipped with SiriusXM with 360L capability and (ii) vehicle is purchased or leased from new INFINITI dealer stock. Trial period begins on the purchase or lease date of the qualifying new INFINITI vehicle. SiriusXM with 360L is owned and operated by SiriusXM, use of SiriusXM account and its services and features are subject to the SiriusXM Customer Agreement and Privacy Policy available at [siriusxm.com](http://siriusxm.com), and are not within INFINITI's control. Should SiriusXM terminate, change, or restrict service or features, service or features may be suspended or terminated without notice or with no liability to INFINITI or its partners or agents. INFINITI and its partners or agents are also not responsible for associated costs or other third party charges that may be required for continued operation due to cellular network unavailability, restriction, or termination (including equipment replacements/upgrades, if available, or roaming charges on alternative networks). Trial period is subject to change or early termination at any time without notice. SiriusXM and related logos are trademarks of Sirius XM Radio Inc. and its respective subsidiaries.
- SiriusXM and SiriusXM with 360L Trial Subscription:** Service will automatically stop at the end of your trial subscription period unless you decide to continue service. Trial is non-transferable. If you do not wish to enjoy your trial, you can cancel by calling the number below. All SiriusXM services require a subscription, each sold separately by SiriusXM after the trial period. Service subject to the SiriusXM Customer Agreement and Privacy Policy, visit [siriusxm.com](http://siriusxm.com) for complete terms and how to cancel which includes online methods or calling 1-866-635-2349. Some services and features are subject to device capabilities and location availability. Satellite service not available in AK & HI. Certain features and/or content may not be available in vehicles with SiriusXM with 360L unless an active data connection is enabled in the vehicle. Content varies by SiriusXM subscription package. All fees, content and features are subject to change.
- 41 Sonar System may not detect every object. Driver should always check surroundings before driving. See Owner's Manual for safety information.
- 42 Traffic Sign Recognition may not detect and read all traffic signs in all conditions. Driver should monitor all traffic signs and obey all traffic laws. See Owner's Manual for details.
- 43 Driver Attention Alert cannot provide a warning in every situation. See Owner's Manual for safety information.
- 44 Air bags are only a supplemental restraint system. Always wear your seat belt. Rear-facing child restraints should not be placed in the front-passenger's seat. All children 12 and under should ride in the rear seat properly secured in child restraints, booster seats or seat belts according to their size. Air bags will only inflate in certain accidents. See Owner's Manual for safety information.
- 45 Tire Pressure Monitoring System is not a substitute for regular tire pressure checks. See Owner's Manual for safety information.
- 46 Vehicle must be on for the Easy-Fill Tire Alert to operate.
- 47 Do not perform slide forward function with the Child Restraint System occupied.
- 48 120-volt power outlet is intended only for use with compatible items. Please check specifications of wattage and amperage of items to be plugged in to determine compatibility.
- 49 Accessories shown on vehicle are not genuine INFINITI parts/accessories. Not warranted by INFINITI. Refer to product manufacturer for warranty details. INFINITI limited warranty does not cover damages or failures of the vehicle caused by improper installation or alterations of any accessory or component. Contact your retailer for details.
- 50 INFINITI® Genuine Accessories Hitch Ball Mount - Class III and Hitch Ball - Class III (2" Coupler) have a maximum towing capacity of up to 5,000 lbs.
- 51 Compatible smartphone required. Virtual Key to be used only in accordance with laws or rules in effect in your vehicle's location. Actual maximum distance for operation will vary depending on obstructions between compatible device and vehicle.
- 52 Tire Road Hazard Protection is not available in Florida.
- 53 Coverage period for 2023-2025 INFINITI models is the earlier to occur event of 36-months or model's designated mileage period, which is as follows: (i) 30,000 miles for Q50 & QX60; (ii) 22,500 miles for QX50 & QX55; and (iii) 45,000 miles for QX80. INFINITI Premium Care is provided through Elite Protection Program. **For complete information concerning components covered, and those components which are excluded from coverage, read a sample Elite Protection Program contract at your retailer, and read your actual service contract because its terms, conditions, exclusions, and limitations control.** In Florida, INFINITI Elite 685004, Protection Program is backed by IESNA, Inc., P.O. Box 685004, Franklin, TN, 37068-5004. License #60128. ELITE® and Elite Protection Program are trademarks of Nissan North America, Inc.
- Amazon, Alexa, Echo, and all related marks are trademarks of Amazon.com, Inc. or its affiliates. Apple®, Apple CarPlay® and Lightning® are registered trademarks of Apple Inc. iPhone® is a registered trademark of Apple Inc. All rights reserved. iPhone® or other external device not included. Pairing speed may vary when establishing Apple CarPlay connection wirelessly. Wireless smartphone integration only supported with CarPlay. Bluetooth® word mark and logos are owned by Bluetooth SIG, Inc., and any use of such marks by INFINITI is under license. DJX® is a registered trademark of the Panasonic Corporation. DynamicAudioReveal™ is a trademark of the Panasonic Corporation. Facebook® is a registered trademark of Meta Platforms, Inc. Google, Android Auto, Google Maps, YouTube Music and other marks are trademarks of Google LLC. Compatible Android phone and compatible active data plan required. To wirelessly use Android Auto on your car display, you need a compatible Android smartphone with an active data plan. You can check which smartphones are compatible at [g.co/androidauto/requirements](http://g.co/androidauto/requirements). Instagram® is a registered trademark of Instagram, LLC. Klipsch® is a registered trademark of Klipsch Group, Inc. Klipsch Reference Premiere™ is a trademark of Klipsch Group, Inc. Klipsch® is a registered trademark of The Chamberlain Group, Inc. Plasmacluster® is a registered trademark of the Sharp Corporation. SiriusXM® is a registered trademark of Sirius XM Radio Inc. X is a trademark of X Corp. Yakima® is a registered trademark of Yakima Products, Inc.
- This brochure is intended for general descriptive and informational purposes only. It is subject to change and does not constitute an offer, representation or warranty (express or implied) by Nissan North America, Inc. Interested parties should confirm the accuracy of any information in this brochure as it relates to a vehicle directly with Nissan North America, Inc. before relying on it to make a purchase decision. Nissan North America, Inc. reserves the right to make changes, at any time, without prior notice, in prices, colors, materials, equipment, specifications, and models and to discontinue models or equipment. Due to continuous product development and other pre- and post-production factors, actual vehicle, materials and specifications may vary from this brochure. Some vehicles shown with optional equipment. See the actual vehicle for complete accuracy. Availability and delivery times for particular models or equipment may vary. Specifications, options and accessories may differ in Hawaii, U.S. territories and other countries. For additional information on availability, options or accessories, contact your INFINITI retailer or Nissan North America, Inc.